



The DNA of tech.™

Product Termination Notification



Product Group: SIL/Wednesday May 20, 2026/PTN-SIL-037-2026-REV-0

Conversion to Copper (Cu) Wire – SQ4937EY

For further information, please contact your regional Vishay office.

CONTACT INFORMATION

Americas

Vishay Siliconix
2565 Junction Ave
-
San Jose CA United States 95134
Phone: (408) 988-8000
Fax:
business-america@vishay.com

Europe

Vishay Electronic GmbH
Dr.-Felix-Zandman-Platz 1
-
Selb Germany 95100
Phone: 49-9287-71 0
Fax: 49-9287-70435
business-europe@vishay.com

Asia

Vishay Intertechnology Asia Pte. Ltd
37A Tampines Street 92 #07-01
-
Singapore Singapore 528886
Phone: 65 6788 6668
Fax: 65 6788 0988
business-asia@vishay.com

Description of Change: The affected part number listed in this notification will be converted from gold (Au) bond wire to a copper (Cu) wire material set. The new ordering code is SQ4937CEY-T1_GE3 which has identical silicon technology and silicon die design as SQ4937EY. Small changes to the data sheet AC parameters are a consequence of lot to lot variation and/or updated characterization methods (reference: SQ4937CEY Doc # 61664 Rev.A). Device performance in the application will not be impacted. There will be no change to the wafer fab location.

Reason for Change: Standardization of materials

Expected Influence on Quality/Reliability/Performance: None

Part Numbers/Series/Families Affected: SQ4937EY-T1_GE3, SQ4937EY-T1_BE3,

Vishay Brand(S): Vishay Siliconix

Time Schedule:

Last Time Buy Date: Monday November 16, 2026

Last Time Ship Date: Saturday May 15, 2027

Sample Availability: Qualified samples of replacement product are available on request.

Product Identification: SQ4937CEY-T1_GE3

Qualification Data: AEC Q101 qualification data of replacement product is available. Qualification PPAP is available on request.

This PTN is considered approved, without further notification, unless we receive specific customer concerns before Thursday July 23, 2026 or as specified by contract.

Issued By: Lance Gurrola, automostechsupprt@vishay.com



Automotive Dual P-Channel 30 V (D-S) 175 °C MOSFET

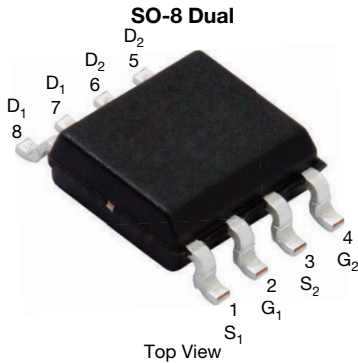

FEATURES

- TrenchFET® power MOSFET
- 100 % R_g and UIS tested
- AEC-Q101 qualified
- Material categorization: for definitions of compliance please see www.vishay.com/doc?99912



RoHS COMPLIANT HALOGEN FREE

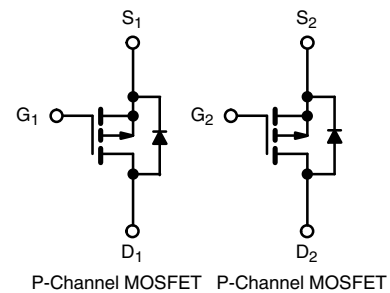

PRODUCT SUMMARY	
V _{DS} (V)	-30
R _{DS(on)} (Ω) at V _{GS} = - 10 V	0.075
R _{DS(on)} (Ω) at V _{GS} = - 4.5 V	0.145
I _D (A) per leg	-5
Configuration	Dual

ORDERING INFORMATION	
Package	SO-8
Lead (Pb)-free and halogen-free	SQ4937CEY (for detailed order number please see www.vishay.com/doc?79771)

ABSOLUTE MAXIMUM RATINGS (T _C = 25 °C, unless otherwise noted)				
PARAMETER		SYMBOL	LIMIT	UNIT
Drain-source voltage		V _{DS}	-30	V
Gate-source voltage		V _{GS}	± 20	
Continuous drain current	T _C = 25 °C	I _D	-5	A
	T _C = 125 °C		-3	
Continuous source current (diode conduction)		I _S	-3	
Pulsed drain current ^a		I _{DM}	-20	
Single pulse avalanche current	L = 0.1 mH	I _{AS}	-10	mJ
Single pulse avalanche energy		E _{AS}	5	
Maximum power dissipation	T _C = 25 °C	P _D	3.3	W
	T _C = 125 °C		1.1	
Operating junction and storage temperature range		T _J , T _{stg}	-55 to +175	°C

THERMAL RESISTANCE RATINGS				
PARAMETER		SYMBOL	LIMIT	UNIT
Junction-to-ambient	PCB mount ^b	R _{thJA}	110	°C/W
Junction-to-foot (drain)		R _{thJF}	45	

- Notes**
- Pulse test; pulse width ≤ 300 μs, duty cycle ≤ 2 %
 - When mounted on 1" square PCB (FR-4 material)



SPECIFICATIONS ($T_C = 25\text{ }^\circ\text{C}$, unless otherwise noted)							
PARAMETER	SYMBOL	TEST CONDITIONS	MIN.	TYP.	MAX.	UNIT	
Static							
Drain-source breakdown voltage	V_{DS}	$V_{GS} = 0\text{ V}$, $I_D = -250\text{ }\mu\text{A}$	-30	-	-	V	
Gate-source threshold voltage	$V_{GS(th)}$	$V_{DS} = V_{GS}$, $I_D = -250\text{ }\mu\text{A}$	-1.5	-2.0	-2.5		
Gate-source leakage	I_{GSS}	$V_{DS} = 0\text{ V}$, $V_{GS} = \pm 20\text{ V}$	-	-	± 100	nA	
Zero gate voltage drain current	I_{DSS}	$V_{GS} = 0\text{ V}$	$V_{DS} = -30\text{ V}$	-	-	-1.0	μA
		$V_{GS} = 0\text{ V}$	$V_{DS} = -30\text{ V}$, $T_J = 125\text{ }^\circ\text{C}$	-	-	-50	
		$V_{GS} = 0\text{ V}$	$V_{DS} = -30\text{ V}$, $T_J = 175\text{ }^\circ\text{C}$	-	-	-150	
On-state drain current ^a	$I_{D(on)}$	$V_{GS} = -10\text{ V}$	$V_{DS} \leq -5\text{ V}$	-15	-	-	A
Drain-source on-state resistance ^a	$R_{DS(on)}$	$V_{GS} = -10\text{ V}$	$I_D = -3.9\text{ A}$	-	0.06	0.075	Ω
		$V_{GS} = -10\text{ V}$	$I_D = -3.9\text{ A}$, $T_J = 125\text{ }^\circ\text{C}$	-	-	0.109	
		$V_{GS} = -10\text{ V}$	$I_D = -3.9\text{ A}$, $T_J = 175\text{ }^\circ\text{C}$	-	-	0.127	
		$V_{GS} = -4.5\text{ V}$	$I_D = -2\text{ A}$	-	0.116	0.145	
Forward transconductance ^b	g_{fs}	$V_{DS} = -15\text{ V}$, $I_D = -3.9\text{ A}$		-	6	-	S
Dynamic ^b							
Input capacitance	C_{iss}	$V_{GS} = 0\text{ V}$	$V_{DS} = -25\text{ V}$, $f = 1\text{ MHz}$	-	351	480	pF
Output capacitance	C_{oss}			-	71	105	
Reverse transfer capacitance	C_{rss}			-	44	70	
Total gate charge ^c	Q_g	$V_{GS} = -10\text{ V}$	$V_{DS} = -15\text{ V}$, $I_D = -4.9\text{ A}$	-	8.4	15	nC
Gate-source charge ^c	Q_{gs}			-	1.7	-	
Gate-drain charge ^c	Q_{gd}			-	1.9	-	
Gate resistance	R_g	$f = 1\text{ MHz}$		2.9	5.78	10.5	Ω
Turn-on delay time ^c	$t_{d(on)}$	$V_{DD} = -15\text{ V}$, $R_L = 15\text{ }\Omega$ $I_D \cong -1\text{ A}$, $V_{GEN} = -10\text{ V}$, $R_g = 1\text{ }\Omega$		-	7	9	ns
Rise time ^c	t_r			-	4	12	
Turn-off delay time ^c	$t_{d(off)}$			-	19	23	
Fall time ^c	t_f			-	3	12	
Source-Drain Diode Ratings and Characteristics ^b							
Pulsed current ^a	I_{SM}			-	-	-20	A
Forward voltage	V_{SD}	$I_F = -3\text{ A}$, $V_{GS} = 0\text{ V}$		-	-0.84	-1.2	V

Notes

- a. Pulse test; pulse width $\leq 300\text{ }\mu\text{s}$, duty cycle $\leq 2\%$
b. Guaranteed by design, not subject to production testing
c. Independent of operating temperature

Stresses beyond those listed under "Absolute Maximum Ratings" may cause permanent damage to the device. These are stress ratings only, and functional operation of the device at these or any other conditions beyond those indicated in the operational sections of the specifications is not implied. Exposure to absolute maximum rating conditions for extended periods may affect device reliability.



TYPICAL CHARACTERISTICS ($T_A = 25\text{ }^\circ\text{C}$, unless otherwise noted)

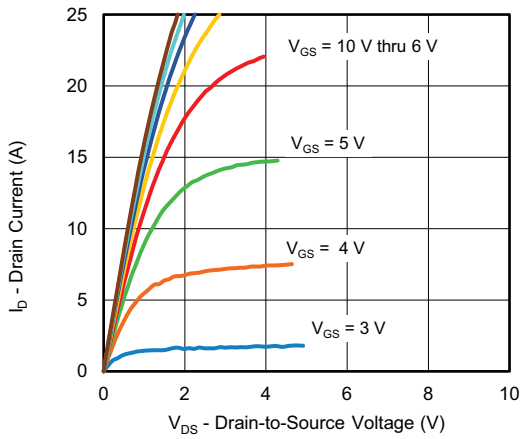

Output Characteristics

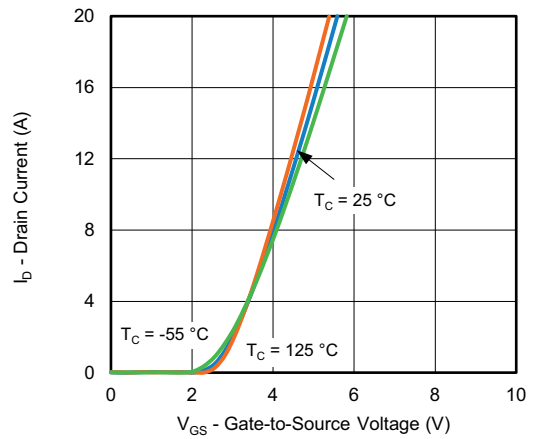

Transfer Characteristics

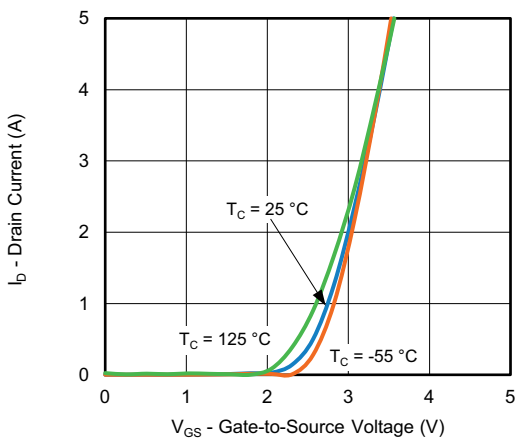

Transfer Characteristics

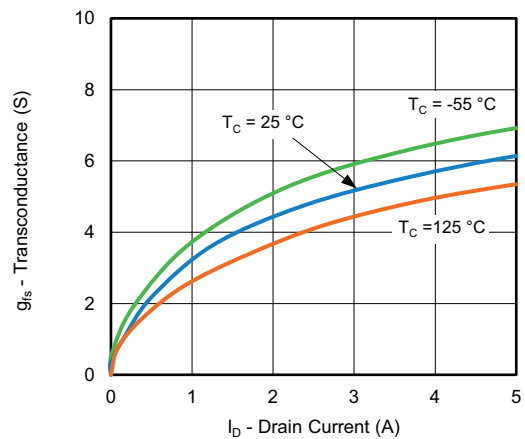

Transconductance

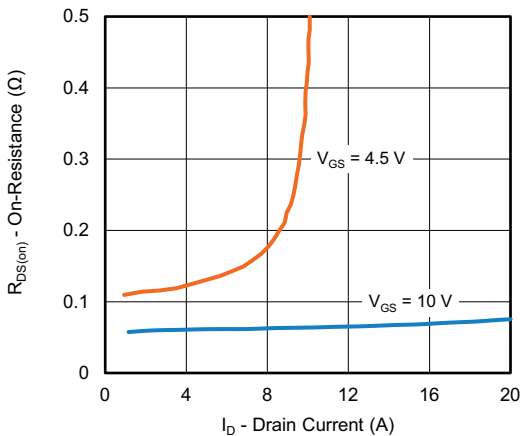

On-Resistance vs. Drain Current

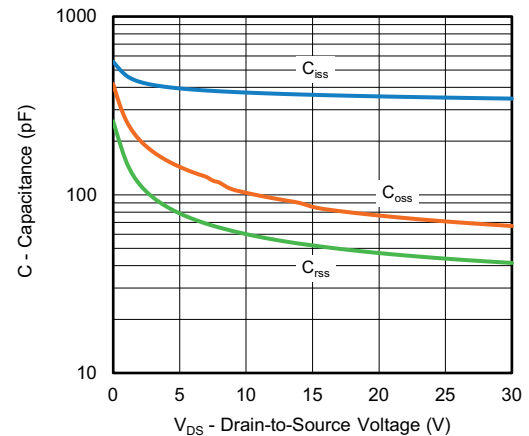

Capacitance



TYPICAL CHARACTERISTICS ($T_A = 25\text{ }^\circ\text{C}$, unless otherwise noted)

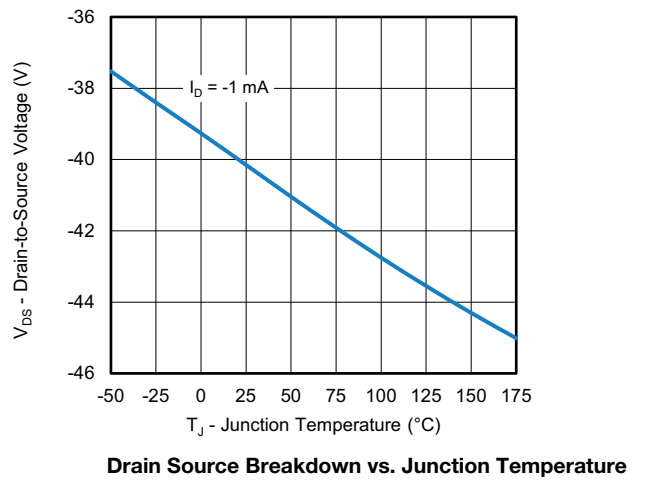
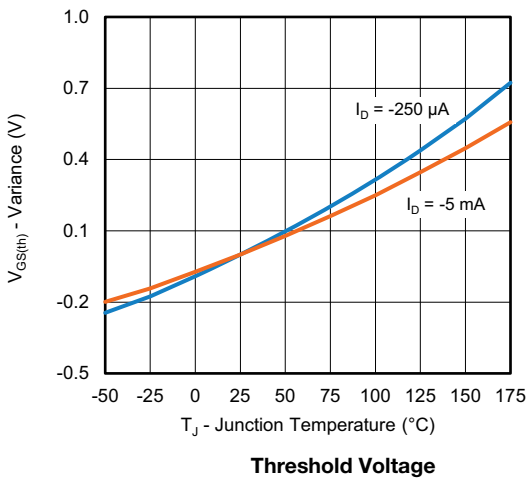
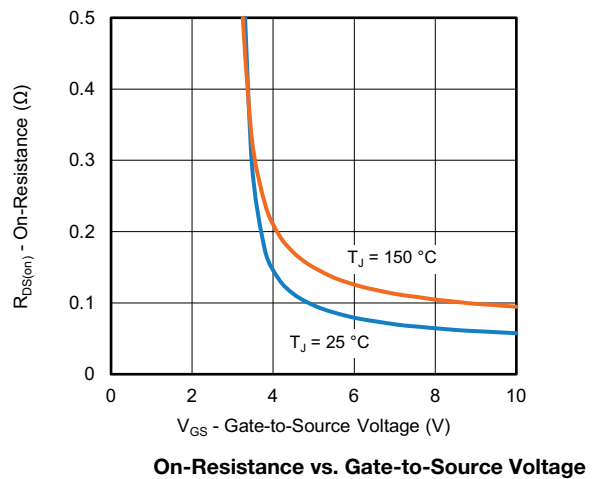
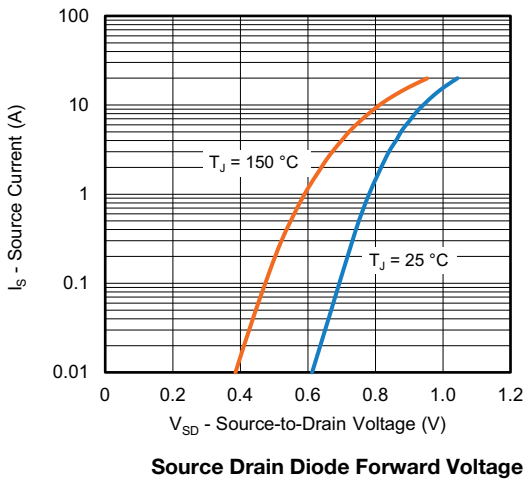
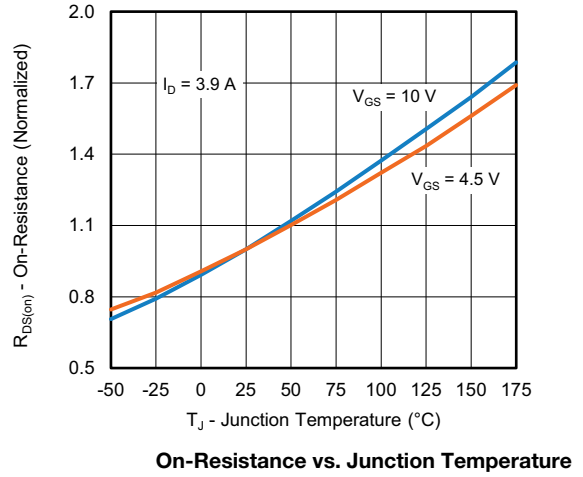
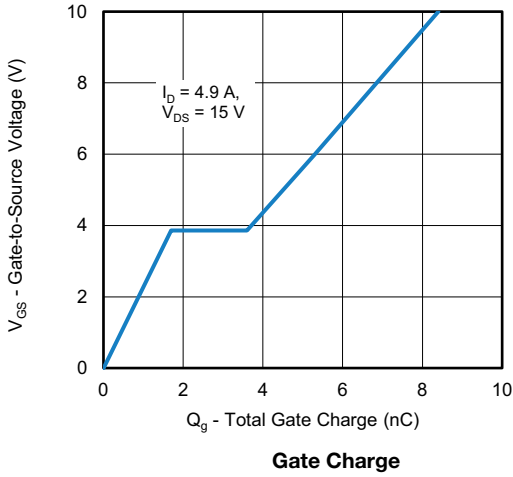



THERMAL RATINGS ($T_A = 25\text{ }^\circ\text{C}$, unless otherwise noted)

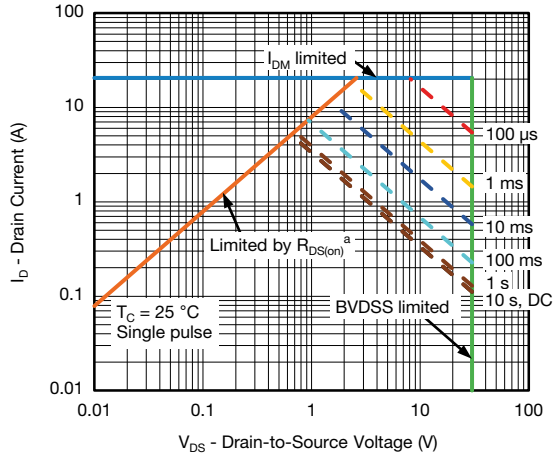

Safe Operating Area

Note

a. $V_{GS} >$ minimum V_{GS} at which $R_{DS(on)}$ is specified



THERMAL RATINGS ($T_A = 25\text{ }^\circ\text{C}$, unless otherwise noted)

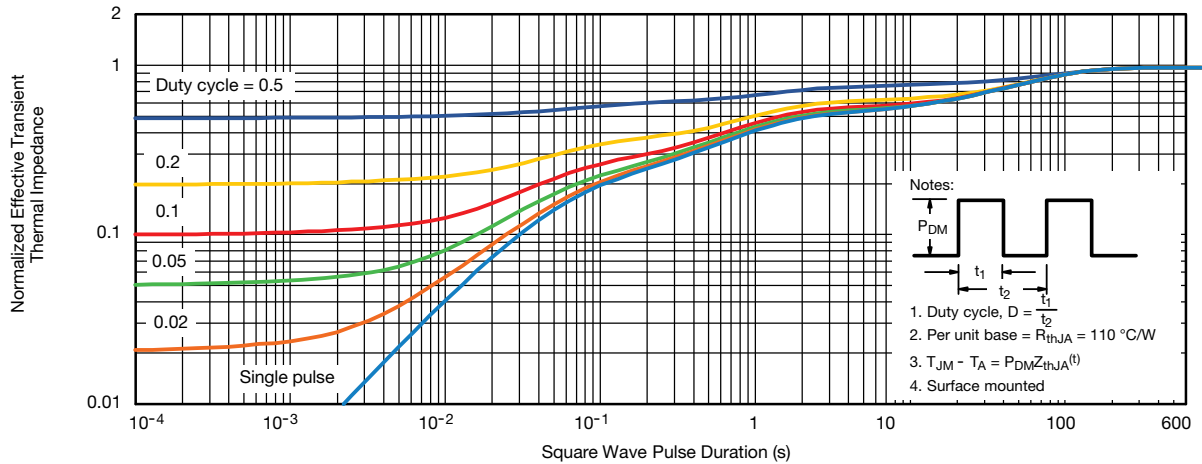

Normalized Thermal Transient Impedance, Junction-to-Ambient

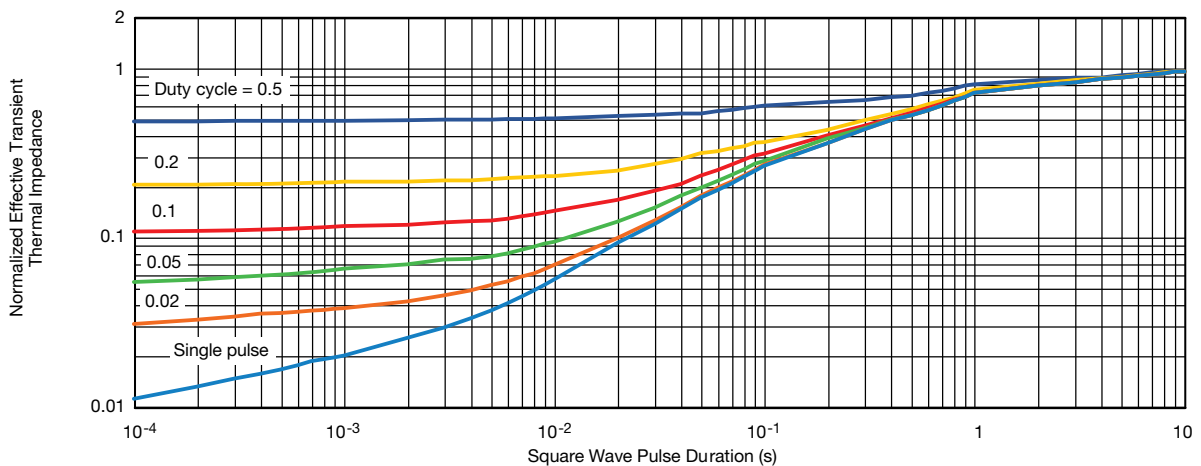

Normalized Thermal Transient Impedance, Junction-to-Foot

Note

- The characteristics shown in the two graphs
 - Normalized Transient Thermal Impedance Junction-to-Ambient ($25\text{ }^\circ\text{C}$)
 - Normalized Transient Thermal Impedance Junction-to-Foot ($25\text{ }^\circ\text{C}$)
- are given for general guidelines only to enable the user to get a "ball park" indication of part capabilities. The data are extracted from single pulse transient thermal impedance characteristics which are developed from empirical measurements. The latter is valid for the part mounted on printed circuit board - FR4, size 1" x 1" x 0.062", double sided with 2 oz. copper, 100 % on both sides. The part capabilities can widely vary depending on actual application parameters and operating conditions

Vishay Siliconix maintains worldwide manufacturing capability. Products may be manufactured at one of several qualified locations. Reliability data for Silicon Technology and Package Reliability represent a composite of all qualified locations. For related documents such as package/tape drawings, part marking, and reliability data, see www.vishay.com/ppg?61664.



Disclaimer

ALL PRODUCT, PRODUCT SPECIFICATIONS AND DATA ARE SUBJECT TO CHANGE WITHOUT NOTICE TO IMPROVE RELIABILITY, FUNCTION OR DESIGN OR OTHERWISE.

Vishay Intertechnology, Inc., its affiliates, agents, and employees, and all persons acting on its or their behalf (collectively, "Vishay"), disclaim any and all liability for any errors, inaccuracies or incompleteness contained in any datasheet or in any other disclosure relating to any product.

Vishay makes no warranty, representation or guarantee regarding the suitability of the products for any particular purpose or the continuing production of any product. To the maximum extent permitted by applicable law, Vishay disclaims (i) any and all liability arising out of the application or use of any product, (ii) any and all liability, including without limitation special, consequential or incidental damages, and (iii) any and all implied warranties, including warranties of fitness for particular purpose, non-infringement and merchantability.

Statements regarding the suitability of products for certain types of applications are based on Vishay's knowledge of typical requirements that are often placed on Vishay products in generic applications. Such statements are not binding statements about the suitability of products for a particular application. It is the customer's responsibility to validate that a particular product with the properties described in the product specification is suitable for use in a particular application. Parameters provided in datasheets and / or specifications may vary in different applications and performance may vary over time. All operating parameters, including typical parameters, must be validated for each customer application by the customer's technical experts. Product specifications do not expand or otherwise modify Vishay's terms and conditions of purchase, including but not limited to the warranty expressed therein.

Hyperlinks included in this datasheet may direct users to third-party websites. These links are provided as a convenience and for informational purposes only. Inclusion of these hyperlinks does not constitute an endorsement or an approval by Vishay of any of the products, services or opinions of the corporation, organization or individual associated with the third-party website. Vishay disclaims any and all liability and bears no responsibility for the accuracy, legality or content of the third-party website or for that of subsequent links.

Vishay products are not designed for use in life-saving or life-sustaining applications or any application in which the failure of the Vishay product could result in personal injury or death unless specifically qualified in writing by Vishay. Customers using or selling Vishay products not expressly indicated for use in such applications do so at their own risk. Please contact authorized Vishay personnel to obtain written terms and conditions regarding products designed for such applications.

No license, express or implied, by estoppel or otherwise, to any intellectual property rights is granted by this document or by any conduct of Vishay. Product names and markings noted herein may be trademarks of their respective owners.

Vishay Material Code	Customer Material	Location
SQ4937EY-T1_GE3	SLNSQ4937EY-T1/GE3	Maisach Gernlinden