

To: \_\_\_\_\_

**Change Notice : Change of LED chip & Wire Bonding Method for Photocouplers**

We appreciate your continuous patronage of our semiconductor products.

This letter is to inform you that Toshiba is planning the following changes in photocouplers which you are currently using. Your continuous support and patronage would be highly appreciated.

**1. Affected product:**

No	Change description	Affected products
1	Change of LED chip	Refer to the attachment
2	Change of Wire bonding method	

**2. Description of the change:**

No.	Change item	Description of the change
1	Change of LED chip	Toshiba will change LED chip mounted in our photocouplers to another LED chip that have been used in our different product type approximately hundreds of millions of pieces for the past 10 years. The chip shows equivalent characteristics before and after the change.
2	Change of Wire bonding method	The wire bonding method will be changed to the one for other product type with the same package to unify the bonding condition.

**3. Reason of the change:**

No.	Change item	Reason of the change
1	Change of LED chip	The current LED chip uses a material that has difficulties in substitutability and availability. Toshiba therefore change it to an alternative LED chip that does not use the material.
2	Change of Wire bonding method	The wire bonding method will be unified to the one for other product type using the same package and the same type of LED chip (e.g. TLP5212), aiming to simplify the process control.

**4. Product characteristics and reliability:**

The change would not impact to the product characteristics and reliability.  
(See the explanatory material for the details).

**5. Request from Toshiba:**

- Regarding the above change, we plan to switch it from the production in December 2024, and we would like to receive your approval by November 13, 2024.
- It would be appreciated if you could verify the submitted evaluation results as soon as possible. If you have questions, please contact us through our sales representatives.

Sincerely yours,



H. Matsuo / Manager  
Quality Planning Group  
Quality Assurance Department  
Buzen Toshiba Electronics Corporation

(Person in charge: K. Nishida, N. Miyoshi)

◆ **Description of the change** ◆

- 1. Change of LED chip**
- 2. Change of bonding method**

**TOSHIBA**

Optical Isolation Application Engineering Gr.  
Optoelectronic Device Development Dept.  
Toshiba Electronic Devices & Storage Corporation

Quality Assurance Dept.  
Buzen Toshiba Electronics Corporation

May 21, 2024

- ◆ Description of the change ◆
  - 1 . Change of LED chip

# Outline

- **Affected Part Name:** Refer to the following page.
- **Change details:** Toshiba will change the LED chip mounted in our photocouplers to another LED chip that has been used in our different product type approximately hundreds of millions of pieces for the past 10 years. The chip shows equivalent characteristics before and after the change.

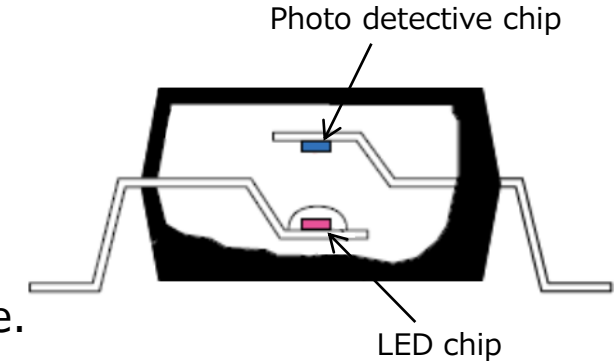

- **Reason for change:** The current LED chip uses a material that has difficulties in substitutability and availability. Toshiba therefore change it to an alternative LED chip that does not use the material.
- **Schedule:** We plan to switch it from the production in December 2024.

• **Appearance of the LED chip before and after the change**

(Unit:  $\mu\text{m}$ )

	Before change	After change
Top view	<p>200</p>	<p>200</p>
Side view	<p>130</p>	<p>115</p>

# List of Affected Part Name Delivered to Your Company

Affected Part Name	PKG
TLP109(***)	S06
TLP2366(***)	S06

# Summary of the Changes (5M1E)

Confidential

Only the LED chip will be changed,  
the other materials and equipment will remain unchanged.

- Change points

5M1E	Any changes	Change details
Man	No	—
Machine	No	—
Material	Yes	Change of LED chip
Method	No	—
Measurement	No	—
Environment	No	—

- Part Name : No change
- Safety Standard Certification No. (Product) : No change
- Environmental data : Only the LED chip data will be changed

# Impact and Evaluation items due to the change of LED chip

Change point	Impact	Factor	Evaluation item
Change of LED chip	Changes in coupling characteristics	Changes in LED optical output	Initial characteristics
	Changes in electrical characteristics	Changes in LED operation voltage	Initial characteristics
	Changes in temperature characteristics	Changes in LED chip temperature characteristics	Temperature characteristics
	Deterioration in product life when powering at high temperature	Deterioration in LED chip optical output	High temperature operating test (HTO)
	Deterioration in product life under high temperature and high humidity environment	Deterioration in optical output due to altered LED surface condition by water penetration	Pressure cooker test (PCT)
	Detachment in Wire bonding / Die bonding	Changes in adhesion between LED chip and Au wire, and Ag paste	Temperature cycling test (TCT) Die shear strength / Ball shear strength

# TLP109

## Evaluation details and the results



Check item	Result
Die bondability (die shear strength) Wire bondability (ball shear strength)	No significant differences
Initial and Temperature characteristics check	No significant differences
Reliability test	No significant differences

No.	Reliability test item	Test condition	Test time	Result
1	High temperature operating test (HTO)	Ta=125°C, IF=9.2mA, PO=100mW	1000h	No significant differences
2	Temperature cycling test (TCT)	-55°C (30min.) to 125°C (30min.)	300cyc	No significant differences
3	Pressure cooker test (PCT)	Ta=121°C, 203kPa (unsaturated)	96h	No significant differences

- In reliability testing, pre-treatment (moisture absorption + reflow) was conducted before testing all of the items above.

# TLP109 Die/Wire bondability check

Confidential

No significant differences were observed before and after the change, and the process capability was confirmed to be satisfactory.

Item	Before change	After change
	Cpk	Cpk
Die shear strength	2.87	2.30
Ball shear strength	3.65	2.52

Before change : n=30pcs  
After change : n=30pcs

## Die shear strength

Before change

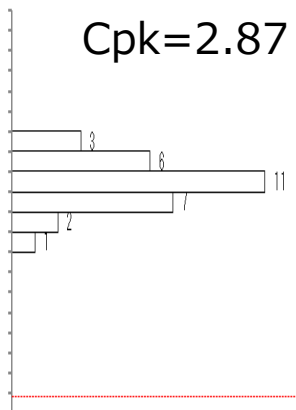

After change

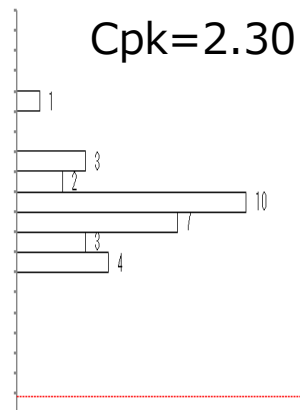

## Ball shear strength

Before change

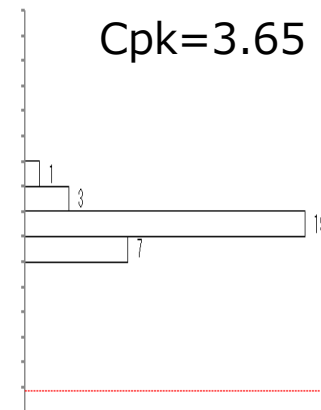

After change

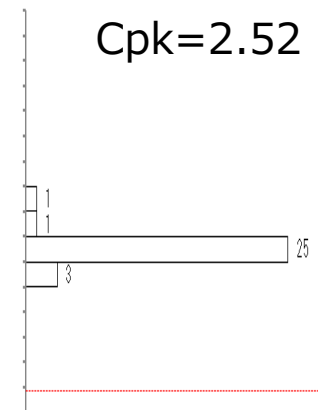

No significant differences were observed before and after the change

Before change : n=30pcs  
 After change : n=30pcs  
 Ta=25°C

Item	Test condition	Specification (TD)			Before change	After change
		Min.	Max.	Unit	Avg.	Avg.
VF	IF=16mA	1.50	1.85	V	1.62	1.61
IR	VR=3V	-	10	μA	0.01 ↓	0.01 ↓
IOH(1)	IF=0mA, VCC=VO=5.5V	-	500	nA	27.0	27.4
IOH(2)	IF=0mA, VCC=30V, VO=20V	-	5	μA	0.1	0.1
ICCH	IF=0mA, VCC=30V	-	1	μA	0.01 ↓	0.01 ↓
IO/IF	IF=16mA, VCC=4.5V, VO=0.4V	20	-	%	47.1	56.5
VOL	IF=16mA, VCC=4.5V, IO=2.4mA	-	0.4	V	0.26	0.25
tpHL	IF=0→16mA, RL=1.9kΩ, VCC=5V	-	0.8	μs	0.28	0.21
tpLH	IF=16→0mA, RL=1.9kΩ, VCC=5V	-	0.8	μs	0.22	0.21

\*Cpks were more than 1.33 in all items

# TLP109 Initial characteristics distribution check

Confidential

No significant differences were observed before and after the change

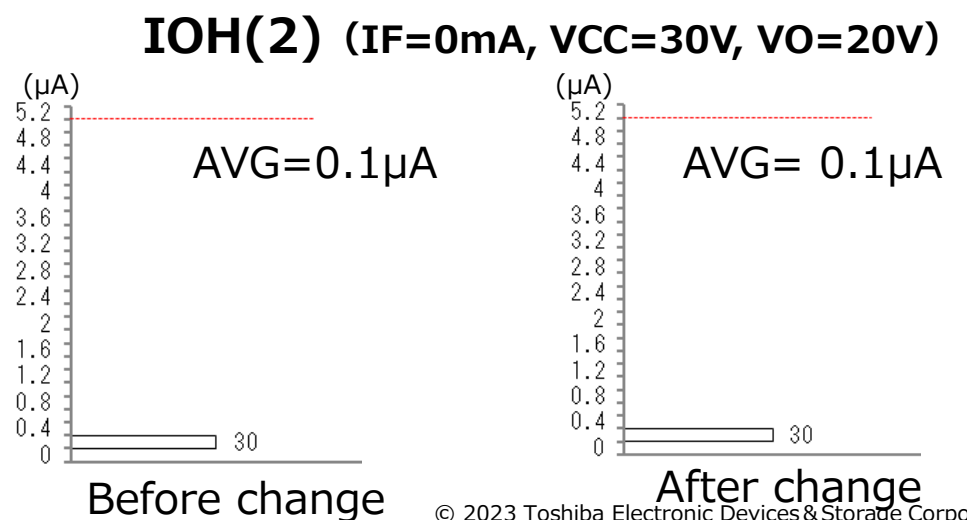
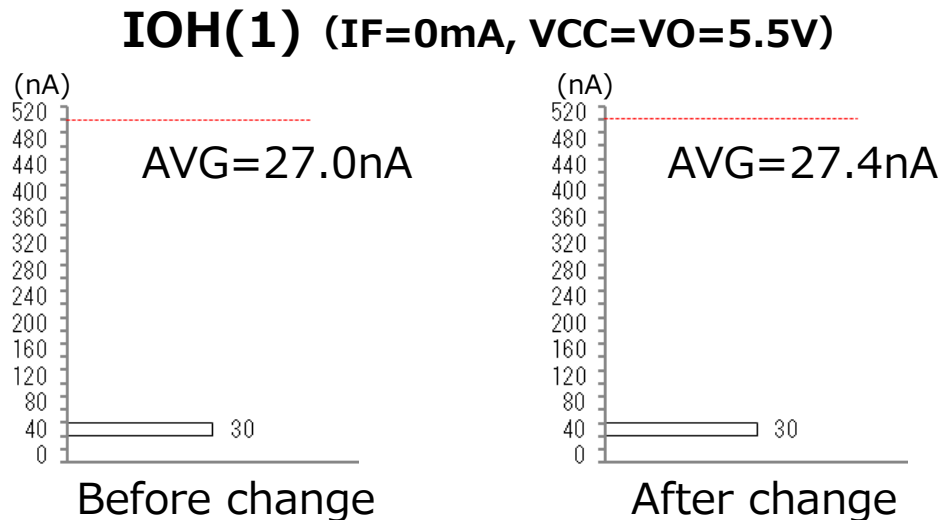
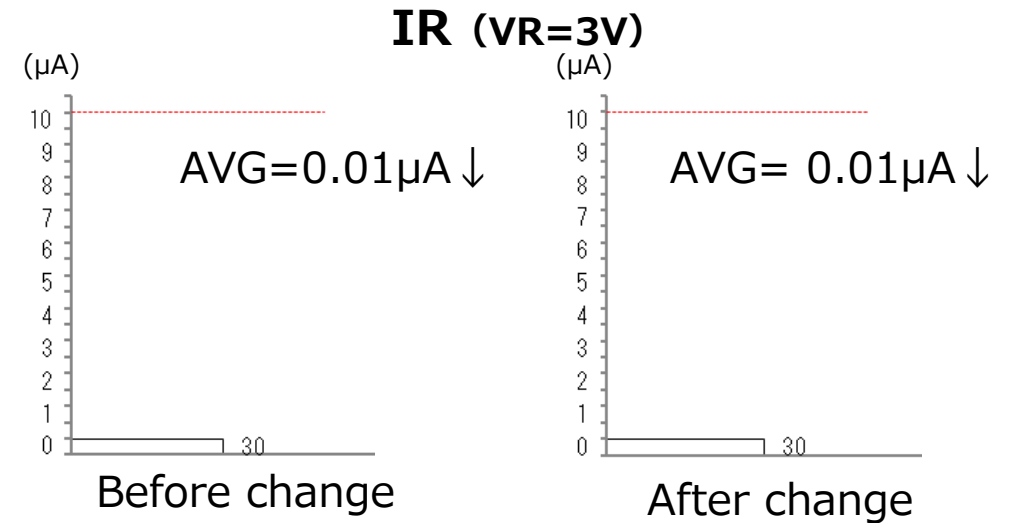
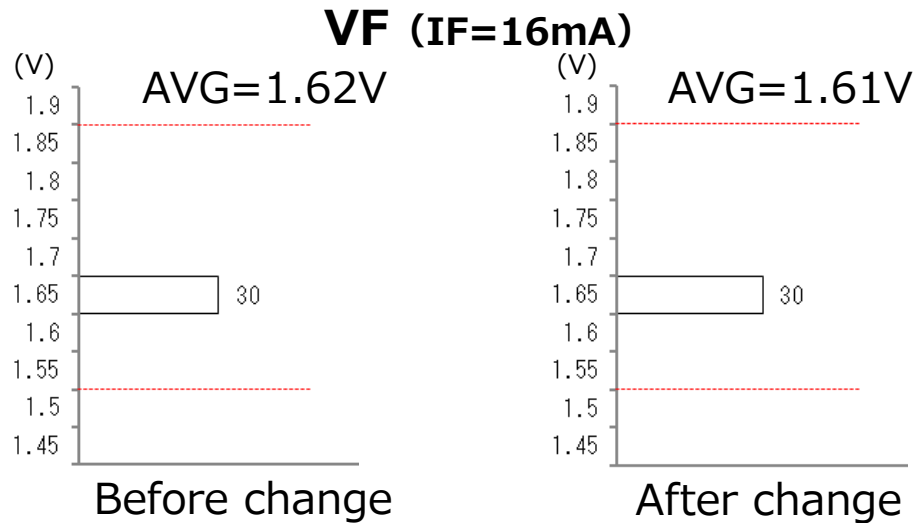

# TLP109 Initial characteristics distribution check

Confidential

No significant differences were observed before and after the change

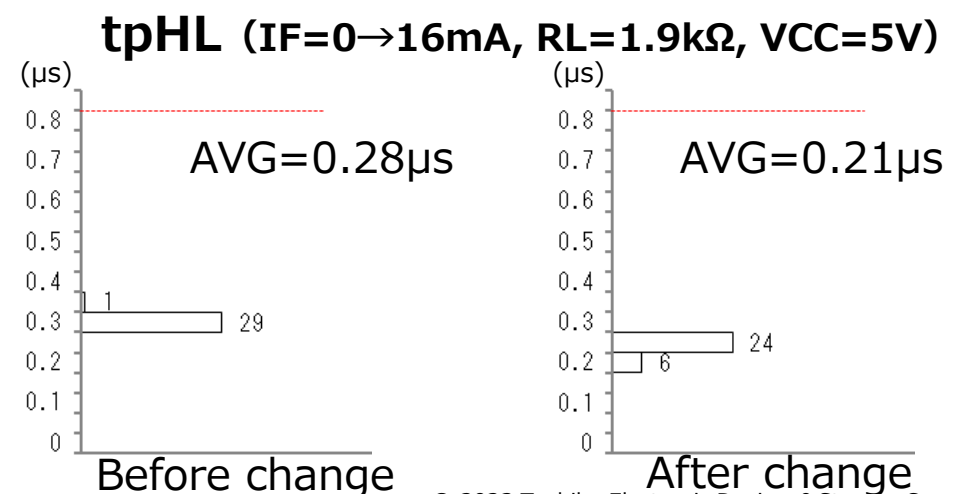
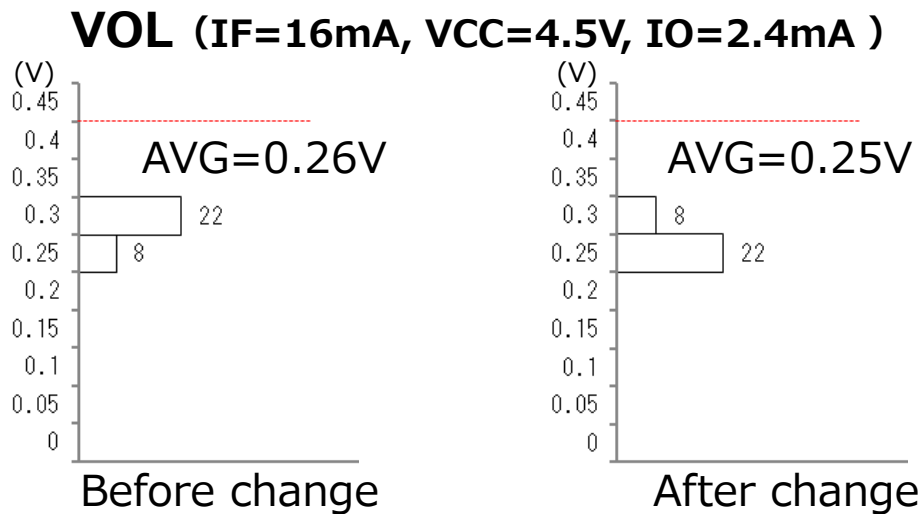
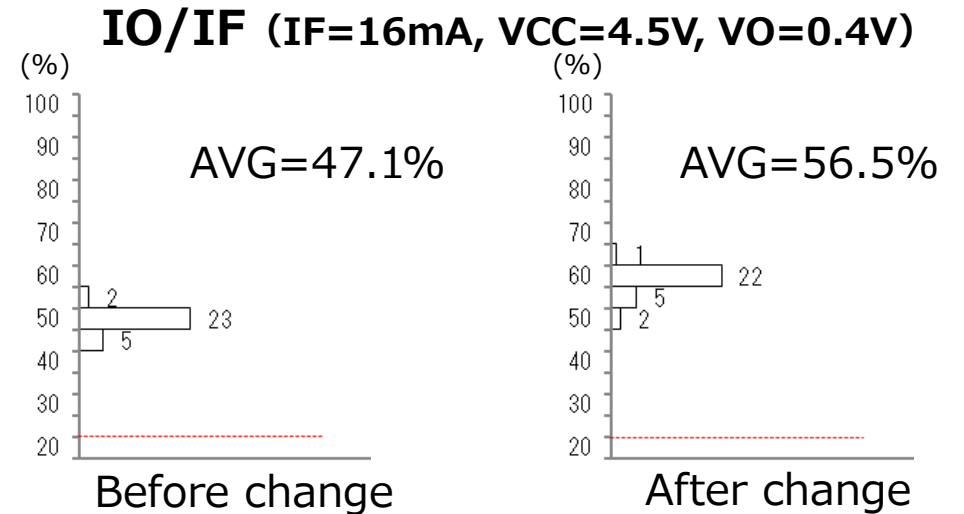
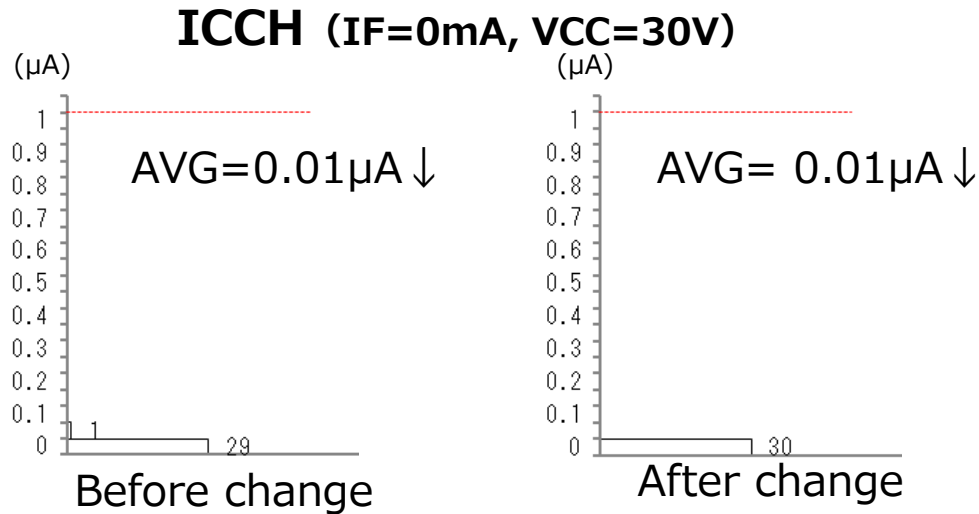

No significant differences were observed before and after the change

**tpLH** (IF=16→0mA, RL=1.9kΩ, VCC=5V)

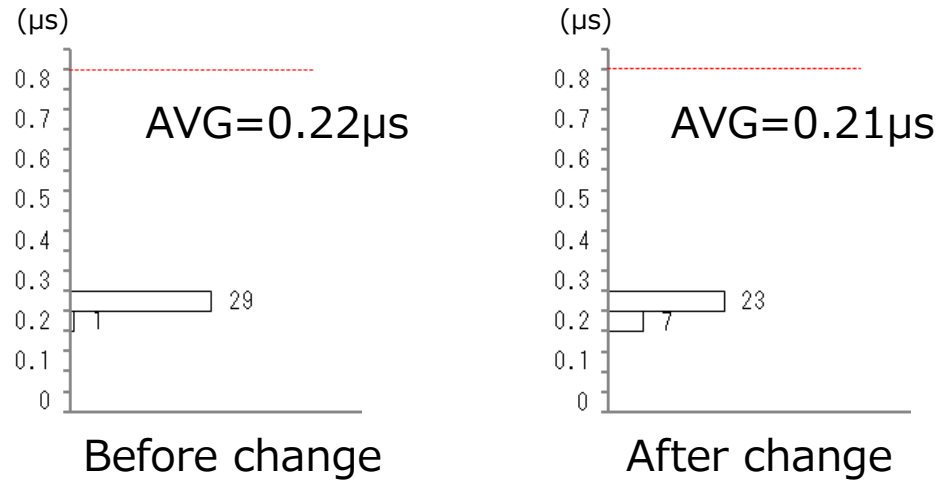

# TLP109 Temperature characteristics check

Confidential

Characteristics fluctuation tendencies depending on the temperature change are almost equivalent

VF(IF=16mA)

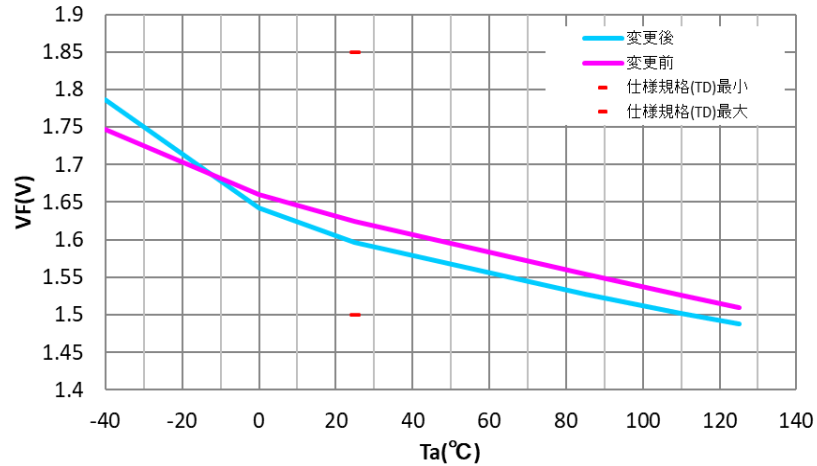

tpHL(IF=16mA,RL=1.9kΩ,VCC=5V)

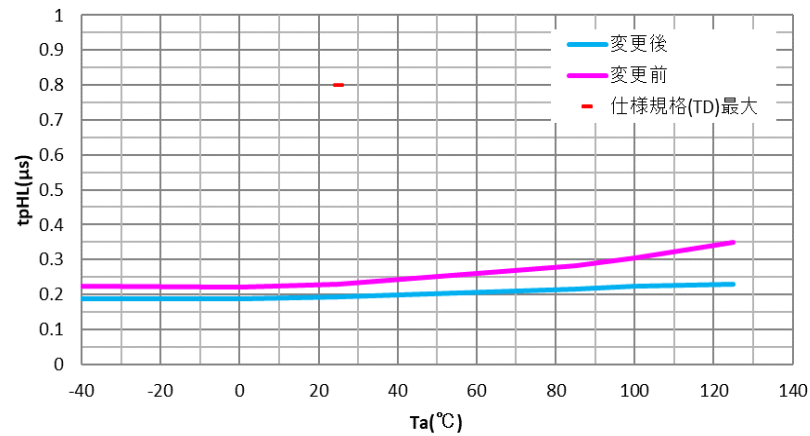

tpLH(IF=16mA,RL=1.9kΩ,VCC=5V)

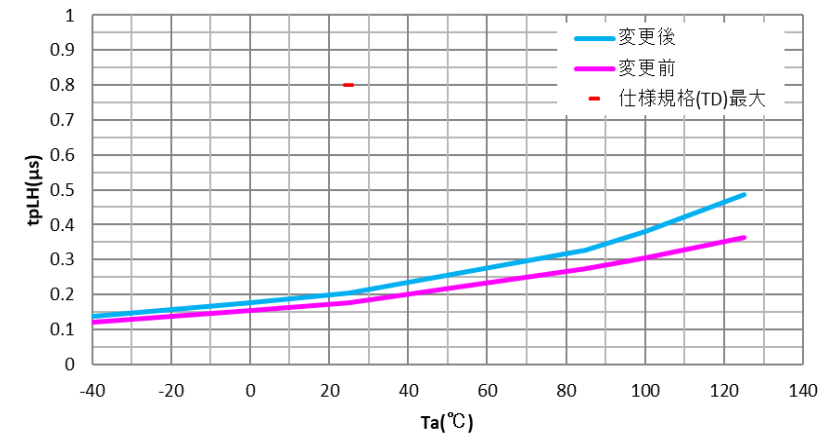

No failures occurred in each test item before and after the change,  
which confirmed the equivalent level.

Before change : n=30pcs  
After change : n=30pcs

No.	Reliability test item	Test condition	Judgement (Failed Q'ty/Tested Q'ty)		
			Test time	Before change	After change
1	High temperature operating test (HTO)	Ta=125°C, IF=9.2mA, PO=100mW	1000h	0/30	0/30
2	Temperature cycling test (TCT)	-55°C (30min.) to 125°C (30min.)	300cyc	0/30	0/30
3	Pressure cooker test (PCT)	Ta=121°C, 203kPa (unsaturated)	96h	0/30	0/30

- Pre-treatment (moisture absorption + reflow) was conducted before testing all of the items above.



# TLP2366

## Evaluation details and the results

Check item	Result
Die bondability (die shear strength) Wire bondability (ball shear strength)	No significant differences
Initial and Temperature characteristics check	No significant differences
Reliability test	No significant differences

No.	Reliability test item	Test condition	Test time	Result
1	High temperature operating test (HTO)	Ta=125°C, IF=15mA, IO=10mA, VCC=5.5V	1000h	No significant differences
2	Temperature cycling test (TCT)	-55°C (30min.) to 125°C (30min.)	300cyc	No significant differences
3	Pressure cooker test (PCT)	Ta=121°C, 203kPa (unsaturated)	96h	No significant differences

- In reliability testing, pre-treatment (moisture absorption + reflow) was conducted before testing all of the items above.

# TLP2366 Die/Wire bondability check

Confidential

No significant differences were observed before and after the change, and the process capability was confirmed to be satisfactory.

Item	Before change	After change
	Cpk	Cpk
Die shear strength	2.87	2.30
Ball shear strength	3.65	3.63

Before change : n=30pcs

After change : n=30pcs

## Die shear strength

Before change

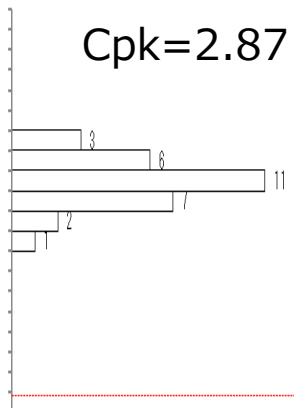

After change

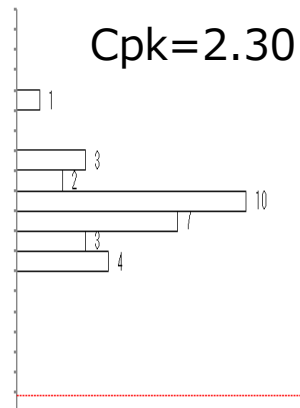

## Ball shear strength

Before change

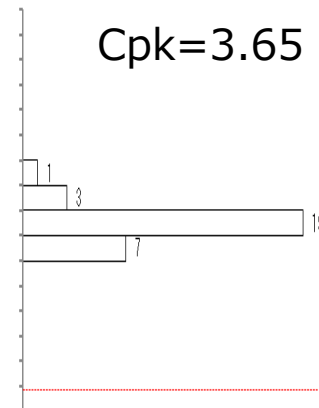

After change

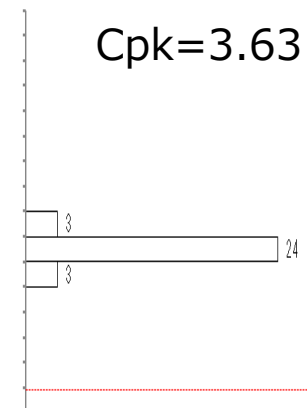

No significant differences were observed before and after the change

Before change : n=30pcs

After change : n=30pcs

Ta=25°C

Item	Test condition	Specification (TD)			Before change	After change
		Min.	Max.	Unit	Avg.	Avg.
VF	IF=10mA	1.45	1.85	V	1.58	1.57
IR	VR=5V	-	10	μA	0.01 ↓	0.01 ↓
VOL	IF=14mA, IO=4mA, VCC=2.7~5.5V	-	0.4	V	0.17	0.16
VOH	VF=1.05V, IO=-4mA, VCC=3.3V	2.3	-	V	3.08	3.08
	VF=1.05V, IO=-4mA, VCC=5V	4	-	V	4.81	4.81
ICCL	IF=14mA, VCC=2.7~5.5V	-	3	mA	1.91	1.95
ICCH	IF=0mA, VCC=2.7~5.5V	-	3	mA	1.62	1.63
IFHL	IO=1.6mA, VO<0.4V, VCC=2.7~5.5V	-	3.5	mA	1.20	0.99

\*Cpks were more than 1.33 in all items

No significant differences were observed before and after the change

Before change : n=30pcs

After change : n=30pcs

Ta=25°C

Item	Test condition	Specification (TD)			Before change	After change
		Min.	Max.	Unit	Avg.	Avg.
tpHL	IF=0→14mA, RIN=100Ω, CL=15pF, VCC=2.7~3.6V	-	40	ns	25.9	22.6
	IF=0→14mA, RIN=100Ω, CL=15pF, VCC=4.5~5.5V	-	45	ns	36.8	33.2
tpLH	IF=14→0mA, RIN=100Ω, CL=15pF, VCC=2.7~3.6V	-	40	ns	21.2	21.9
	IF=14→0mA, RIN=100Ω, CL=15pF, VCC=4.5~5.5V	-	45	ns	20.4	21.2
tpHL-tpLH	IF=14mA, RIN=100Ω, CL=15pF, VCC=2.7~3.6V	-	25	ns	4.7	0.7
	IF=14mA, RIN=100Ω, CL=15pF, VCC=4.5~5.5V	-	25	ns	16.4	12.1

\*Cpks were more than 1.33 in all items

# TLP2366 Initial characteristics distribution check Confidential

No significant differences were observed before and after the change

### VF (IF=10mA)

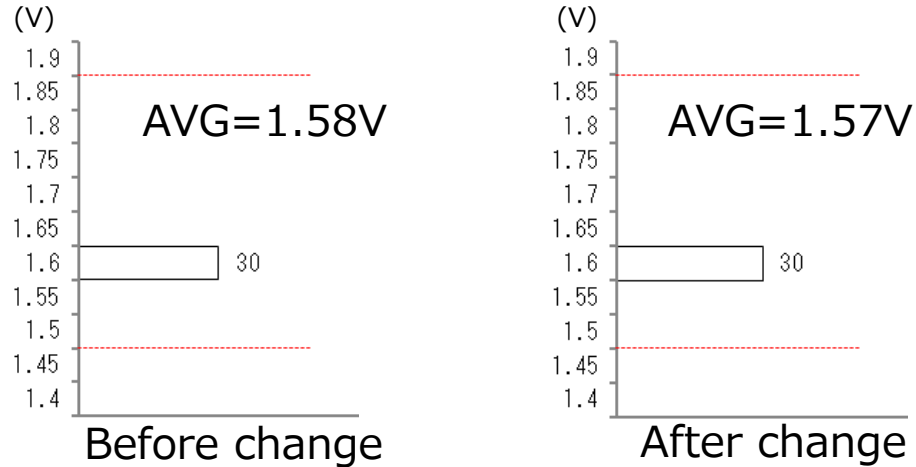

### IR (VR=5V)

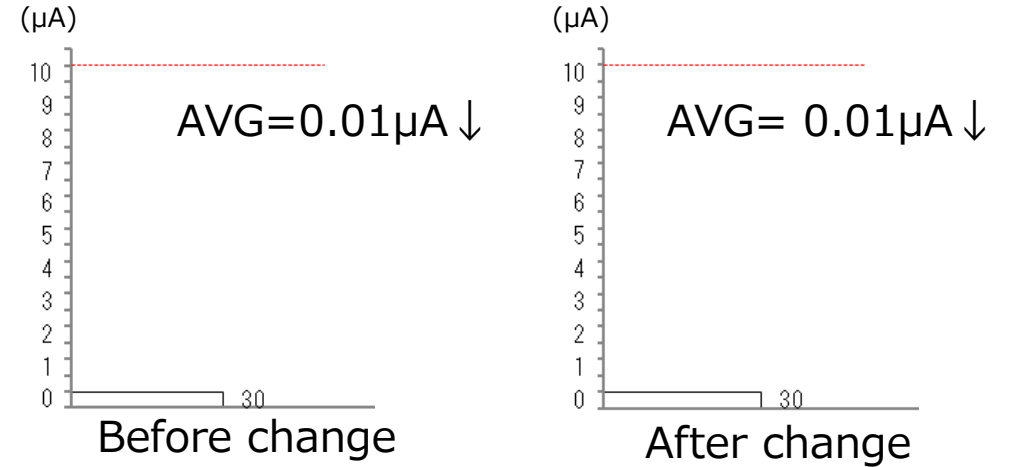

### VOL (IF=14mA, IO=4mA, VCC=5V)

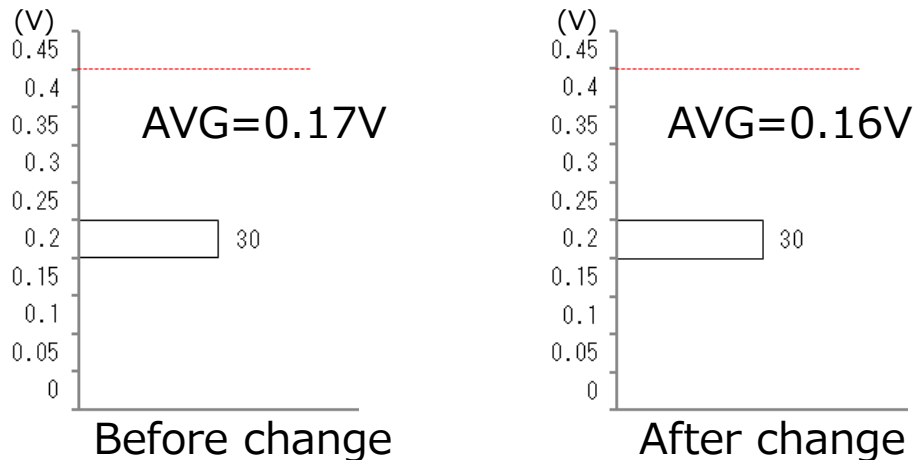

### VOH (VF=1.05V, IO=-4mA, VCC=3.3V)

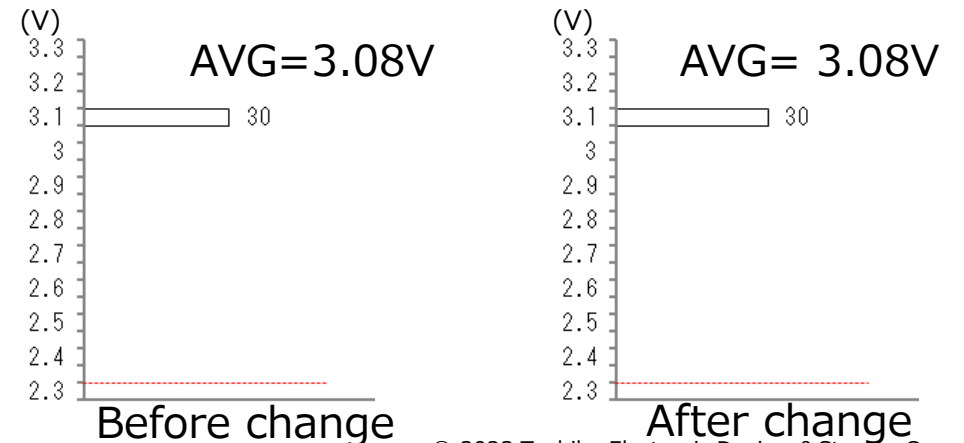

# TLP2366 Initial characteristics distribution check

Confidential

No significant differences were observed before and after the change

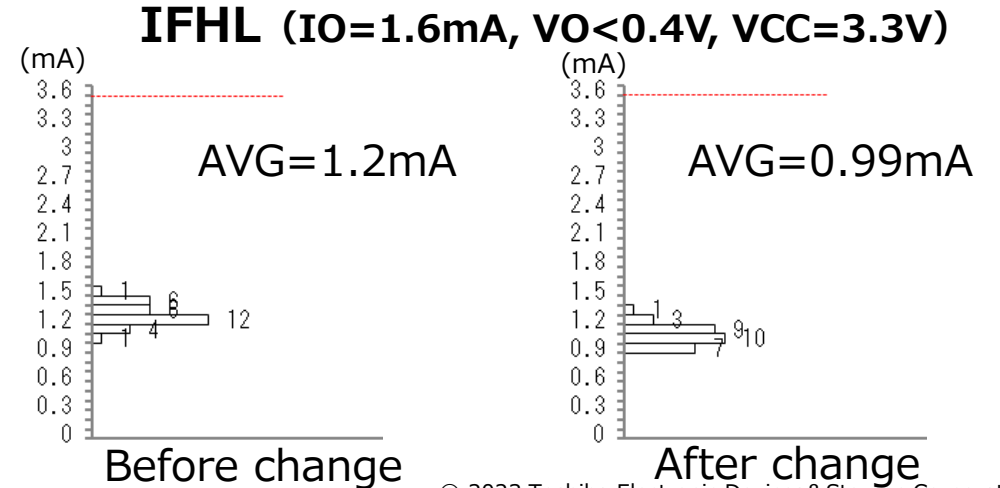
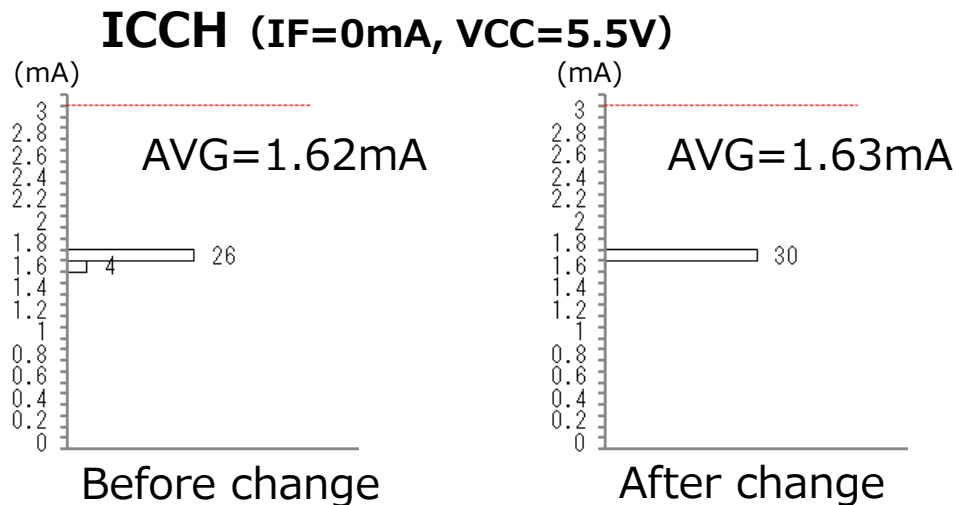
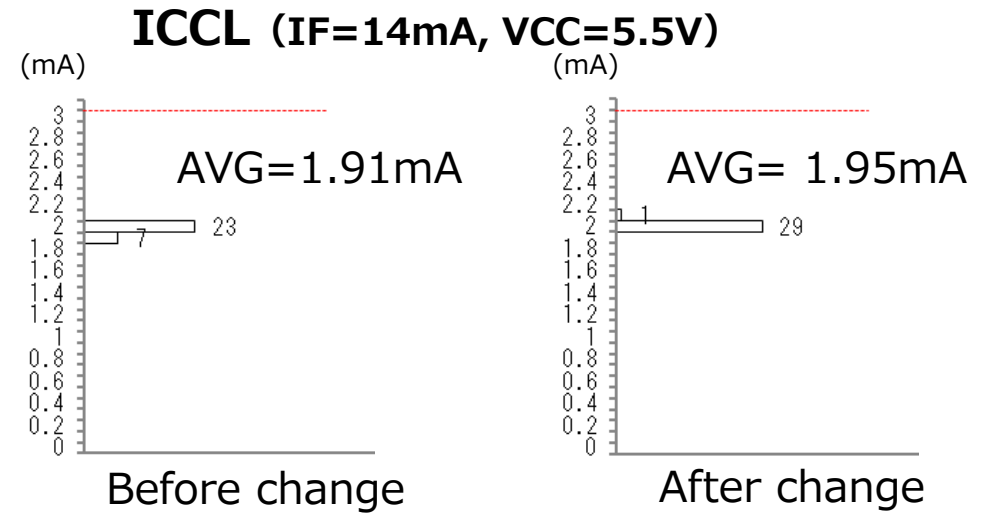
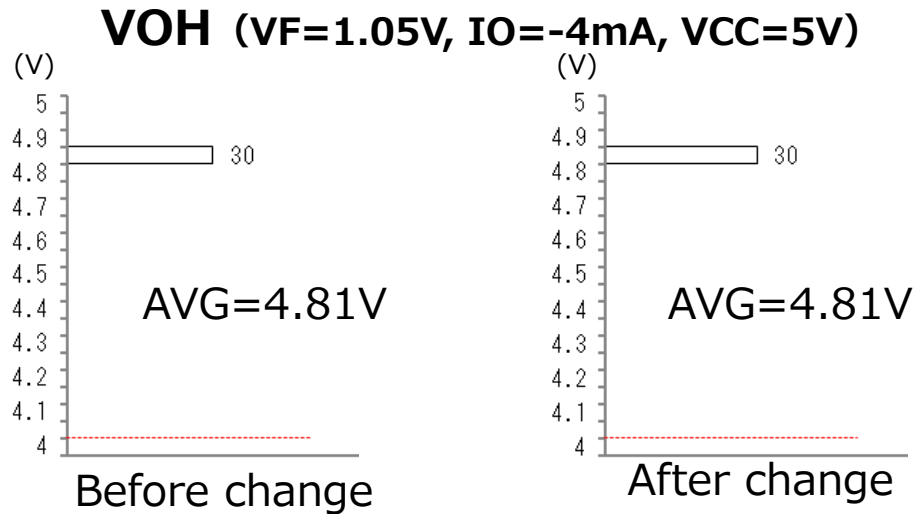

# TLP2366 Initial characteristics distribution check

Confidential

No significant differences were observed before and after the change

**tpHL (IF=0→14mA, RIN=100Ω, CL=15pF, VCC=2.7V)**

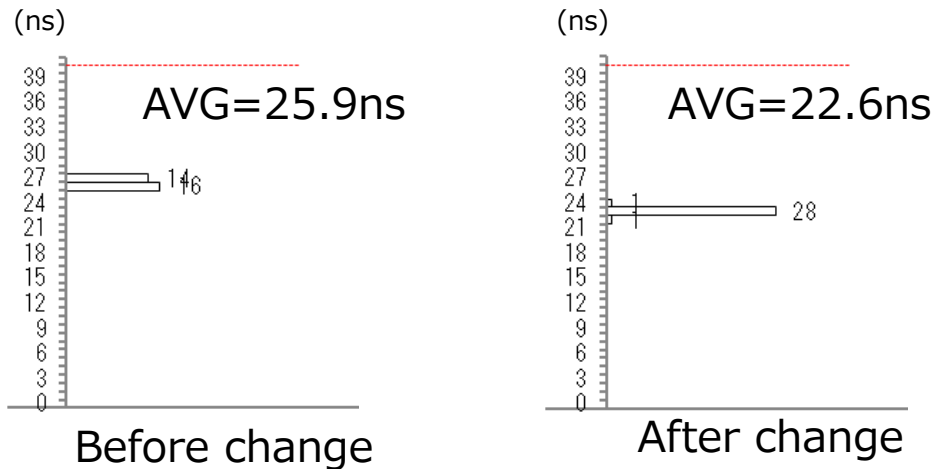

**tpHL (IF=0→14mA, RIN=100Ω, CL=15pF, VCC=5V)**

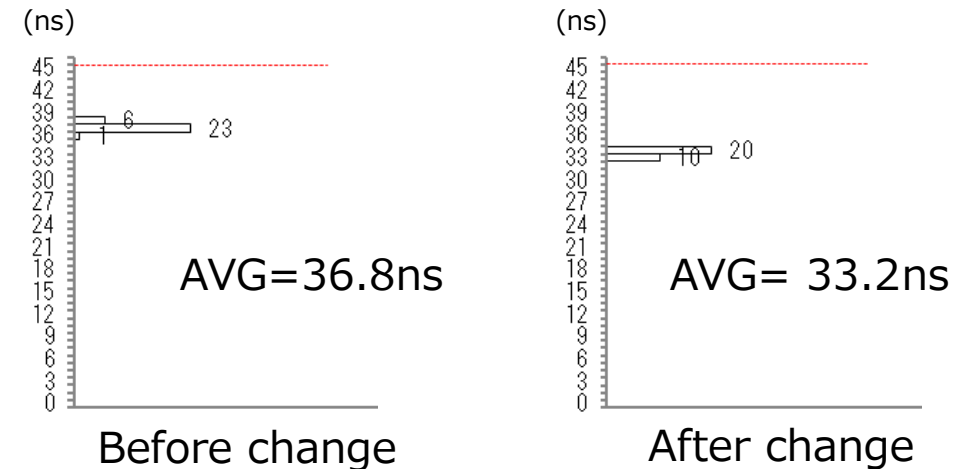

**tpLH (IF=14→0mA, RIN=100Ω, CL=15pF, VCC=2.7V)**

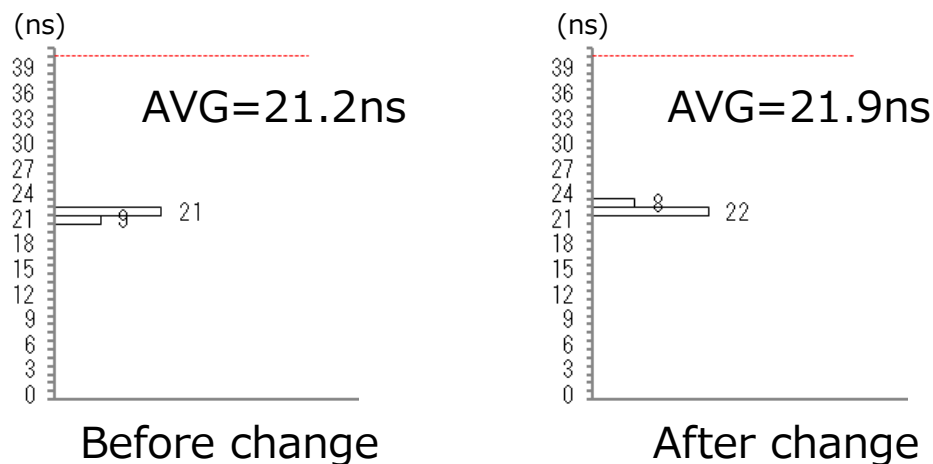

**tpLH (IF=14→0mA, RIN=100Ω, CL=15pF, VCC=5V)**

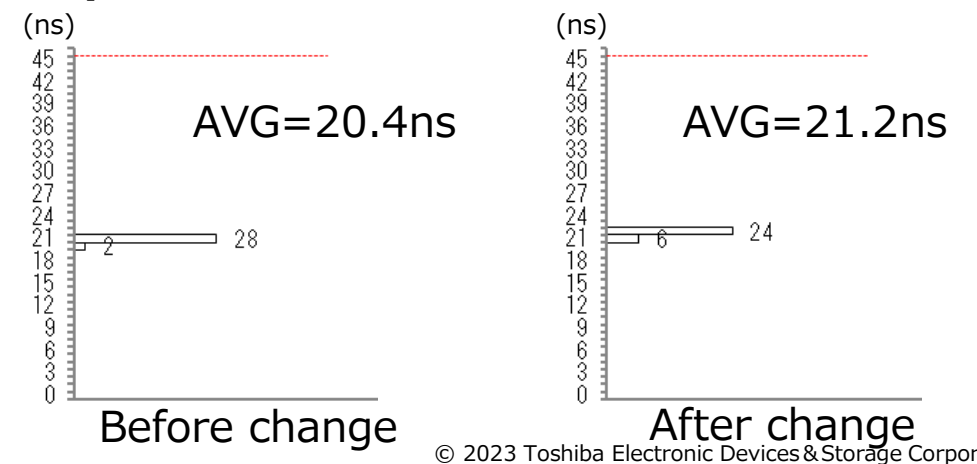



# TLP2366 Initial characteristics distribution check

No significant differences were observed before and after the change

$|\text{tpHL}-\text{tpLH}|$  (IF=14mA, RIN=100Ω, CL=15pF, VCC=2.7V)

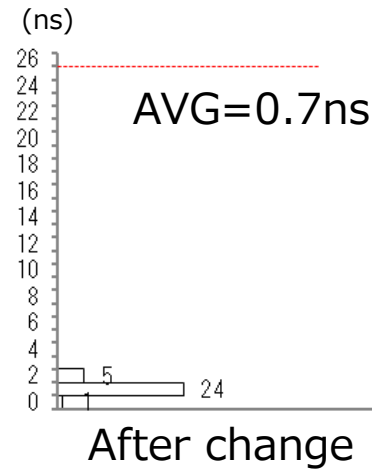
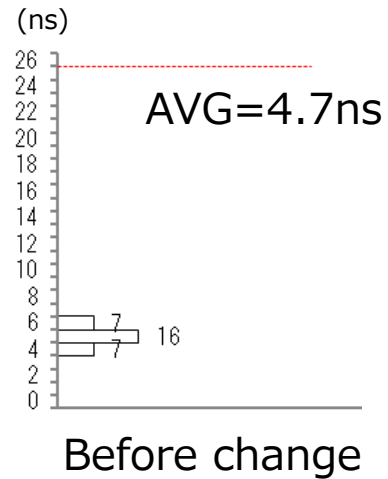

$|\text{tpHL}-\text{tpLH}|$  (IF=14mA, RIN=100Ω, CL=15pF, VCC=5V)

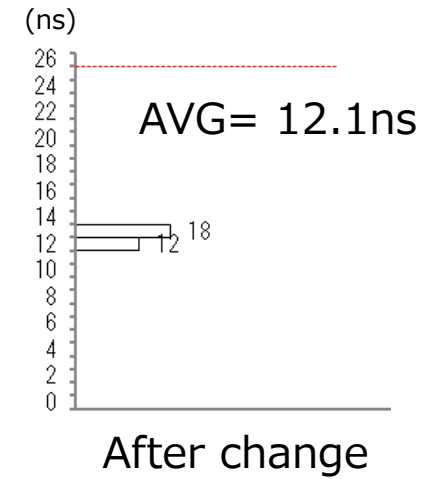
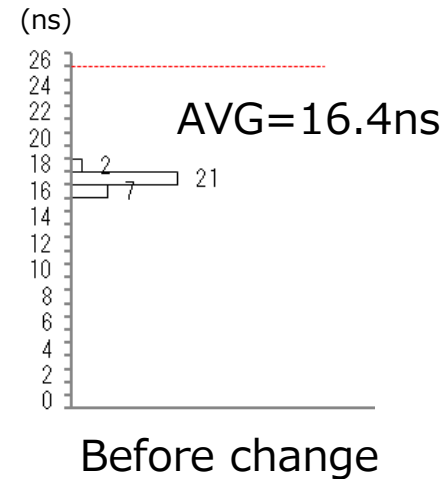

# TLP2366 Temperature characteristics check (DC characteristics)

Confidential

Characteristics fluctuation tendencies depending on the temperature change are almost equivalent

IFHL(I<sub>O</sub>=1.6mA, V<sub>O</sub><0.4V, V<sub>CC</sub>=5V)

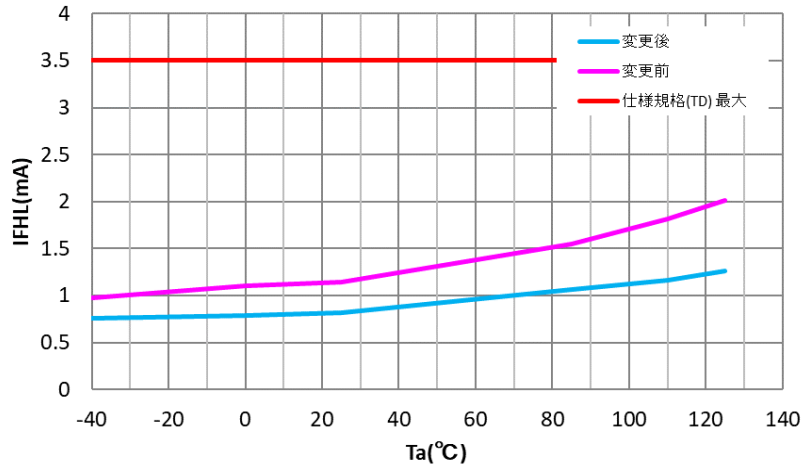

VF(IF=10mA)

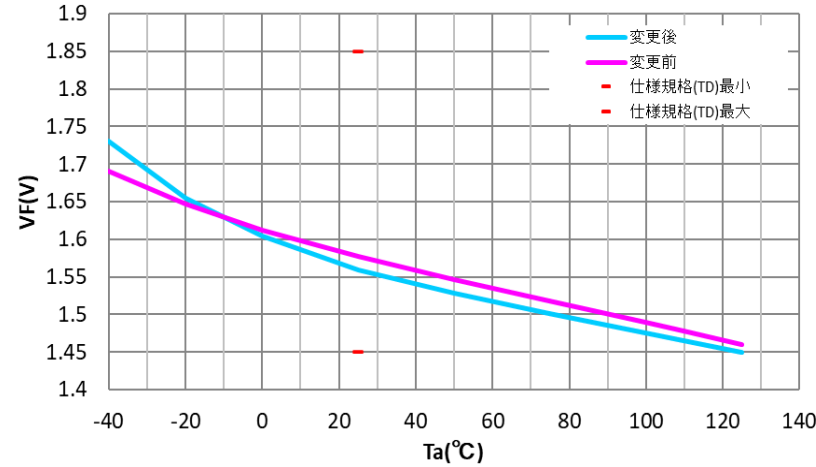

# TLP2366 Temperature characteristics check (Switching characteristics)

Confidential

Characteristics fluctuation tendencies depending on the temperature change are almost equivalent

tpHL(IF=14mA,RIN=100Ω,VCC=5V)

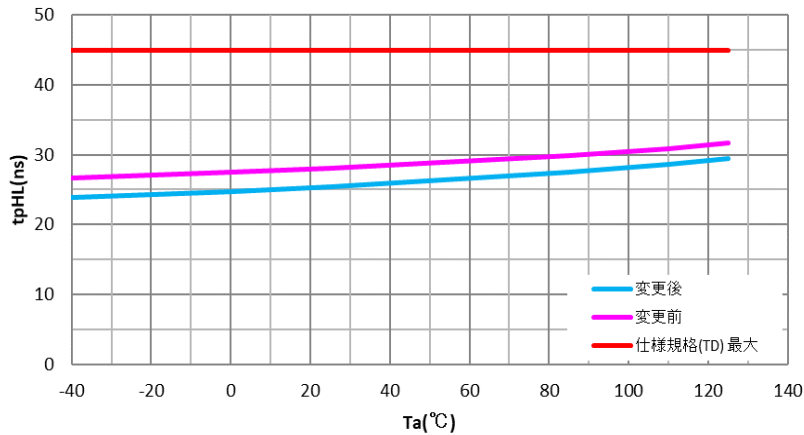

tpLH(IF=14mA,RIN=100Ω,VCC=5V)

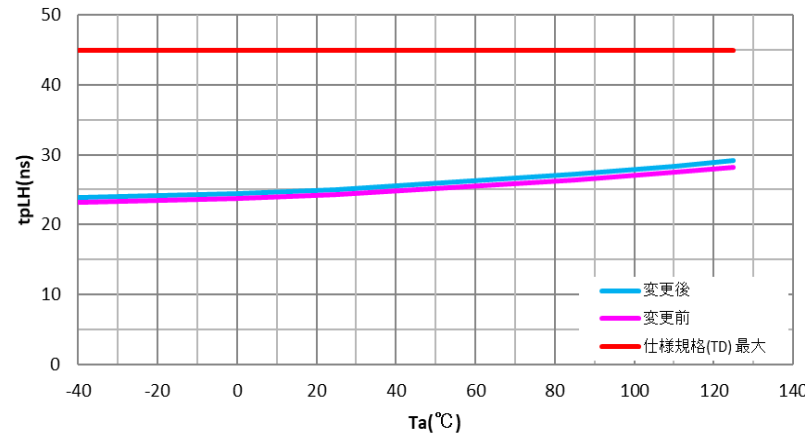

|tpHL-tpLH|(IF=14mA/VCC=5V)

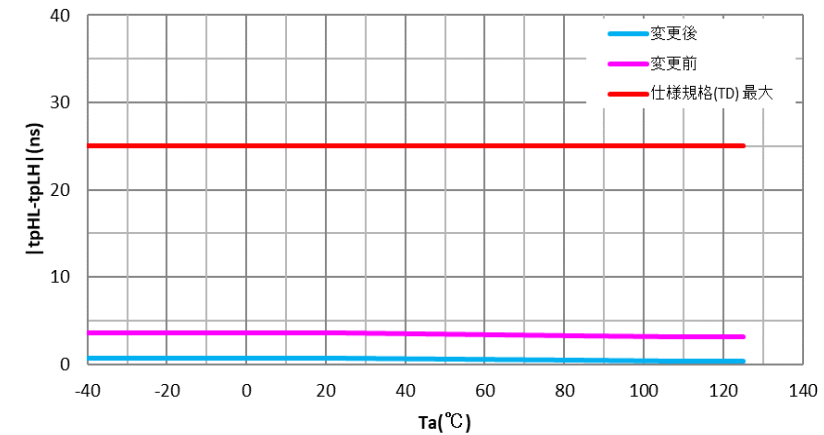

tpHL(IF=6mA,RIN=100Ω,VCC=5V)

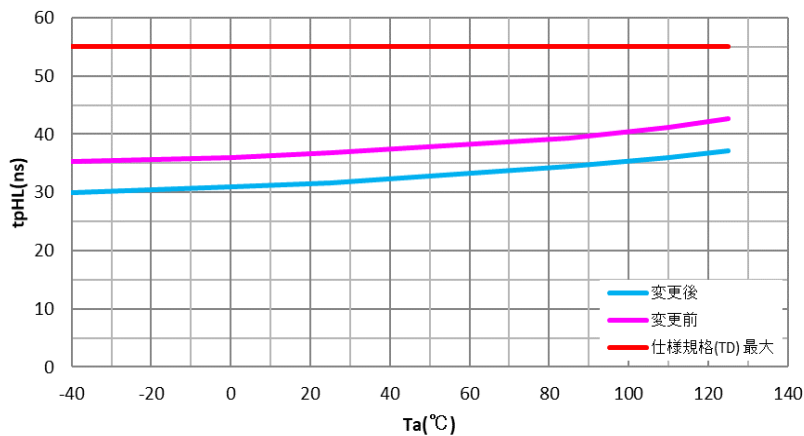

tpLH(IF=6mA,RIN=100Ω,VCC=5V)

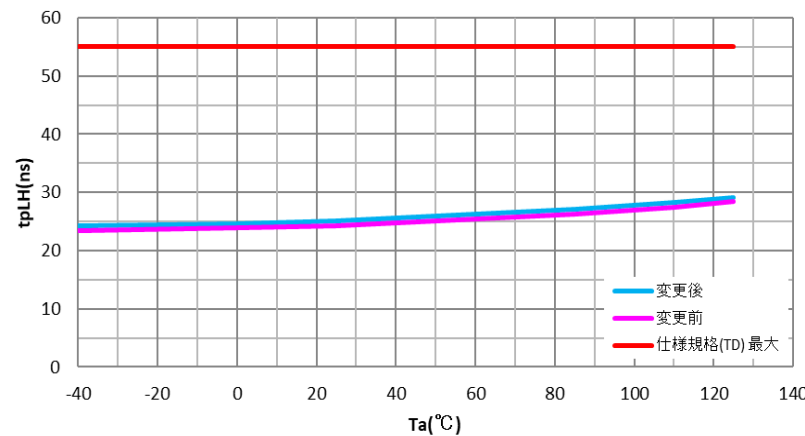

|tpHL-tpLH|(IF=6mA/VCC=5V)

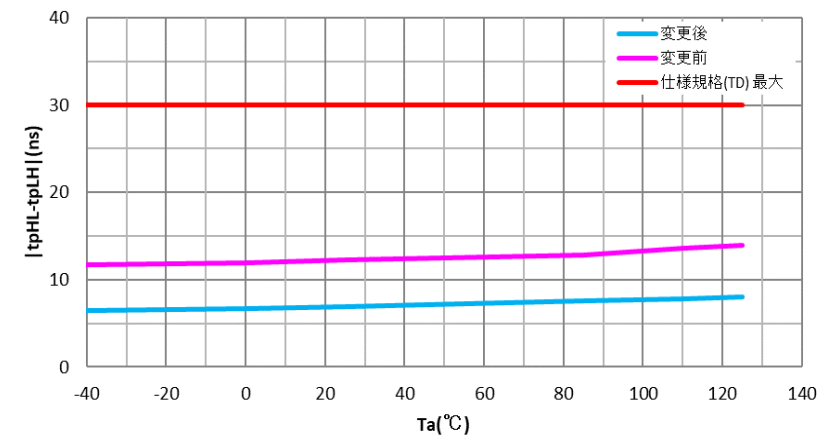

No failures occurred in each test item before and after the change, which confirmed the equivalent level.

Before change : n=30pcs  
After change : n=30pcs

No.	Reliability test item	Test condition	Judgement (Failed Q'ty/Tested Q'ty)		
			Test time	Before change	After change
1	High temperature operating test (HTO)	Ta=125°C, IF=15mA, IO=10mA, VCC=5.5V	1000h	0/30	0/30
2	Temperature cycling test (TCT)	-55°C (30min.) to 125°C (30min.)	300cyc	0/30	0/30
3	Pressure cooker test (PCT)	Ta=121°C, 203kPa (unsaturated)	96h	0/30	0/30

• Pre-treatment (moisture absorption + reflow) was conducted before testing all of the items above.

◆ Description of the change ◆

- 1 . Change of LED chip
- 2 . Change of bonding method

## •Affected Part Name

Refer to the following page.

## •Change details

1. Toshiba will change the LED chip mounted in our photocouplers to another LED chip that has been used in our different product type approximately hundreds of millions of pieces for the past 10 years.

The chip shows equivalent characteristics before and after the change.

2. We also change the wire bonding method to the one for other product type with the same package to unify the bonding condition.

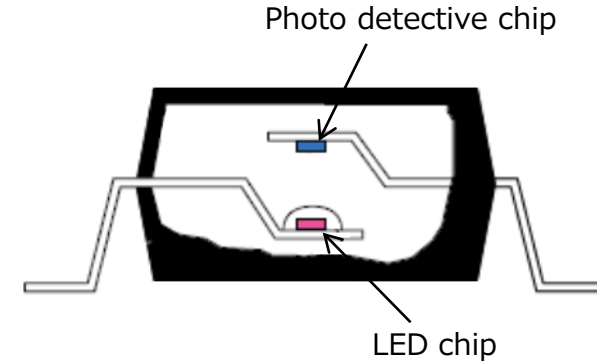

## •Reason for change

1. The current LED chip uses a material that has difficulties in substitutability and availability. Toshiba therefore change it to an alternative LED chip that does not use the material.
2. For the change of wire bonding method, we will unify the bonding method to the one for other product type using the same package and the same type of LED chip (e.g. TLP5212), aiming to simplify the process control.

## •Schedule

We plan to switch it from the production in December 2024.

# List of Affected Part Name Delivered to Your Company

Confidential



Part Name	PKG
TLP5214(***)	SO16L
TLP5214A(***)	SO16L

# Change of LED chip

The LED chip to be changed has already been used in our photocouplers, and is a proven one.

## Appearance of the LED chip before and after the change

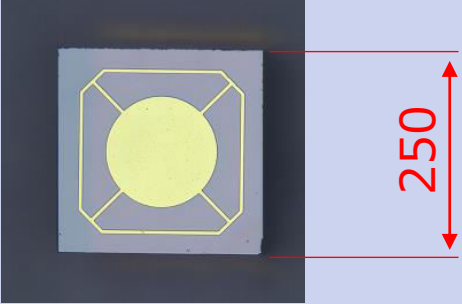
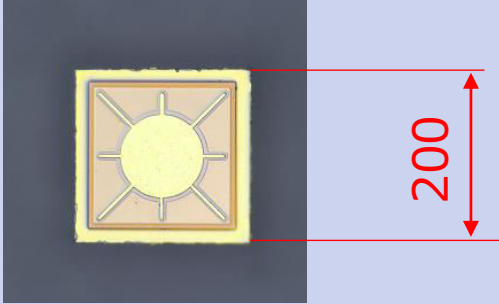
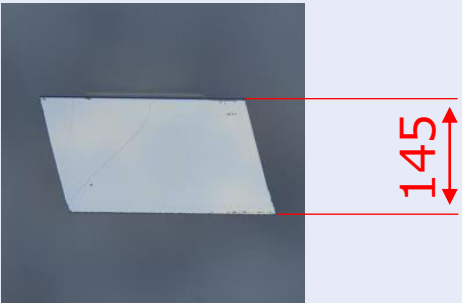
(Unit:  $\mu\text{m}$ )

	Before change	After change
Top view	 <p>250</p>	 <p>200</p>
Side view	 <p>145</p>	 <p>115</p>



# Change of wire bonding method

We will unify the bonding method to the one for other product type using the same package and the same type of LED chip, aiming to simplify the process control.

## Wire bonding method

Frame position		Before change	After change
LED side	Transmitter LED	Low loop	<b>Normal</b>
	Feedback IC	Mixed loop (Normal & Low loop)	<b>BWB</b>
Photo detector side	Driver IC	Normal	<b>BWB</b>
	Feedback LED	Low loop	<b>Normal</b>

## Comparison of before/after the change

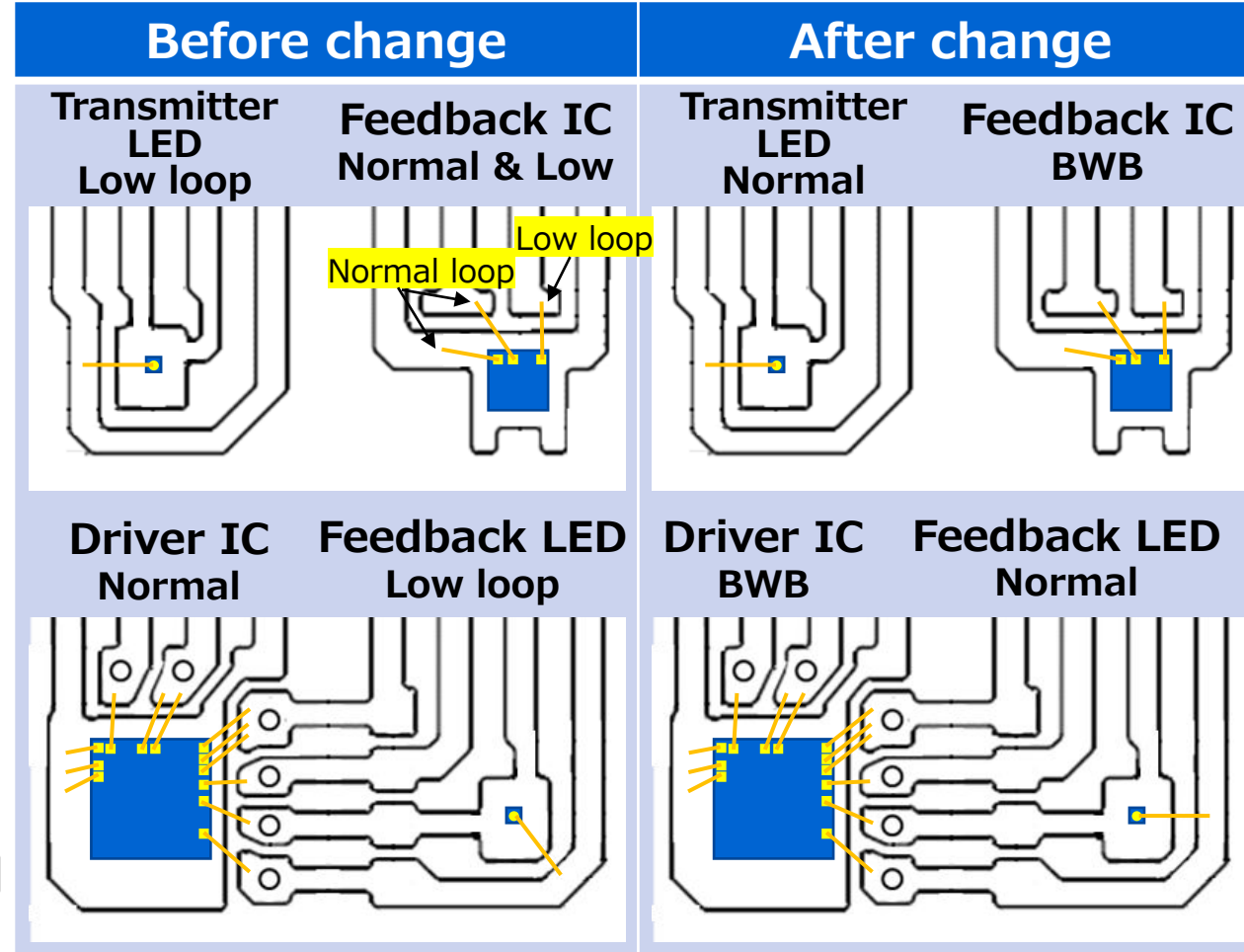

Normal shape

Low loop shape

BWB shape

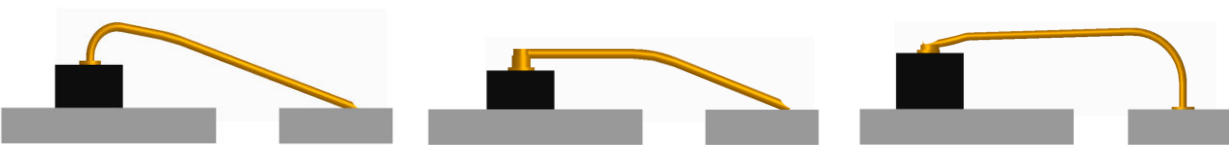

\*To secure isolation margins, the wire bonding position of Feedback LED will be changed.

# Summary of the Changes (5M1E)

LED chip and wire bonding method will be changed,  
the other materials and equipment will remain unchanged.

## •Change points

5M1E	Any changes	Change details
Man	No	—
Machine	No	—
Material	Yes	Change of LED chip
Method	Yes	Change of wire bonding method
Measurement	No	—
Environment	No	—

- Part Name : No change
- Safety Standard Certification No. (Product) : No change
- Environmental data : Only the LED chip data will be changed

# Impact and Evaluation items due to the change of LED chip and wire bonding method

Confidential

Change point	Impact	Factor	Evaluation item
Change of LED chip	Changes in coupling characteristics	Changes in LED optical output	Initial characteristics
	Changes in electrical characteristics	Changes in LED operation voltage	Initial characteristics
	Changes in temperature characteristics	Changes in LED chip temperature and coupling characteristics	Temperature characteristics
	Deterioration in product life when powering at high temperature	Deterioration in LED chip optical output	High temperature operating test (HTO)
	Deterioration in product life under high temperature and high humidity environment	Deterioration in optical output due to altered LED surface condition by water penetration	Pressure cooker test (PCT)
	Detachment in Wire bonding / Die bonding	Changes in adhesion between LED chip and Au wire, and Ag paste	Temperature cycling test (TCT) Die shear strength / Ball shear strength
Change of wire bonding method	Detachment in Wire bonding	Changes in adhesion between LED chip and Au wire	Temperature cycling test (TCT) Ball shear strength

# Evaluation details and the results (TLP5214A was evaluated as a representative)

Check item	Result
Die bondability (die shear strength) Wire bondability (ball shear strength)	No significant differences
Initial and Temperature characteristics check	No significant differences
Reliability test	No significant differences

No.	Reliability test item	Test condition	Test time	Result
1	High temperature operating test (HTO)	Ta=110°C, IF=10mA, IO=±4A, VCC2-(VE-VEE)=30V, VE=VEE=GND	1000h	No significant differences
2	Temperature cycling test (TCT)	-55°C (30min.) to 125°C (30min.)	300cyc	No significant differences
3	Pressure cooker test (PCT)	Ta=121°C, 203kPa (unsaturated)	96h	No significant differences

- Pre-treatment (moisture absorption + reflow) was conducted before testing all of the items above.

# TLP5214A Check of Die/Wire Bondability

Confidential

No significant differences were observed before and after the change, and the process capability was confirmed to be satisfactory.

Item	Before change	After change
	Cpk	Cpk
Die shear strength	2.86	1.66
Ball shear strength	4.66	2.95

Before change : n=30pcs

After change : n=30pcs

## Die shear strength

Before change

Cpk=2.86

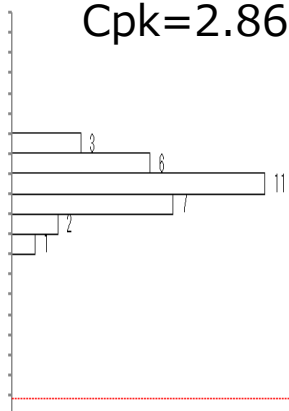

After change

Cpk=1.66

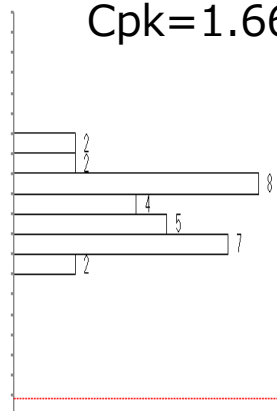

## Ball shear strength

Before change

Cpk=4.66

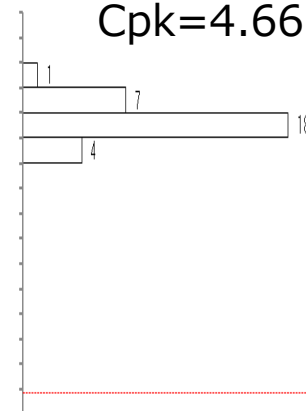

After change

Cpk=2.95

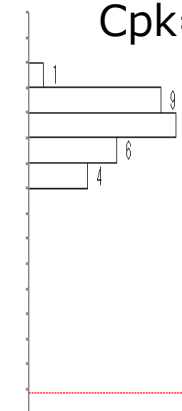

# TLP5214A Initial characteristics check

Confidential

No significant differences were observed before and after the change

Before change : n=30pcs, After change: n=30pcs Ta=25°C

Item	Test condition	Specification (TD)			Before change	After change
		Min.	Max.	Unit	Avg.	Avg.
VF	IF=10mA	1.4	1.7	V	1.54	1.56
IR	VR=5V	-	10	μA	0.01 ↓	0.01 ↓
VFAULTL	IFault=1.1mA, VCC1=5.5V	-	0.4	V	0.15	0.17
	IFault=1.1mA, VCC1=3.3V	-	0.4	V	0.15	0.17
IFaultH	VFault=5.5V, VCC1=5.5V	-	0.5	μA	0.01 ↓	0.01 ↓
	VFault=5.5V, VCC1=3.3V	-	0.3	μA	0.01 ↓	0.01 ↓
IOPH	VO=VCC2-4V, VCC2-VEE=15~30V	-	-1.2	A	-2.17	-2.17
	VO=VCC2-7V, VCC2-VEE=15~30V	-	-3.0	A	-5.40	-5.40
IOPL	VO=VEE2+2.5V, VCC2-VEE=15~30V	1.2	-	A	3.91	3.90
	VO=VEE2+7V, VCC2-VEE=15~30V	3	-	A	4.67	4.63

\*Cpks were more than 1.33 in all items

# TLP5214A Initial characteristics check

Confidential

No significant differences were observed before and after the change

Before change : n=30pcs, After change: n=30pcs Ta=25°C

Item	Test condition	Specification (TD)			Before change	After change
		Min.	Max.	Unit	Avg.	Avg.
IOLF	VO-VEE=14V, VCC2-VEE=15~30V	90	230	mA	149.1	149.3
VOH	IO=-100mA, VCC2=30V	VCC2-0.3	-	V	30.0	30.0
VOL	IO=100mA, VCC2-VEE=15~30V	-	0.2	V	0.05	0.05
ICL	VO=VEE+2.5V, VCC2-VEE=15~30V	0.56	-	A	1.87	1.87
ICC2H	IO=0mA, VCC2-VEE=15~30V	-	3.8	mA	2.61	2.61
ICC2L	IO=0mA, VCC2-VEE=15~30V	-	3.8	mA	2.50	2.50
ICHG	VDESAT=2V	-0.33	-0.13	mA	-0.26	-0.26
IDSCHG	VDESAT=7V	10	-	mA	43.5	43.0
VDESAT	VCC2-VE > VUVLO-	5.9	7.5	V	6.47	6.44
VUVLO+	VO > 5V	10.5	13.5	V	11.35	11.33

\*Cpks were more than 1.33 in all items



# TLP5214A Initial characteristics check

Confidential

No significant differences were observed before and after the change

Before change : n=30pcs, After change: n=30pcs Ta=25°C						
Item	Test condition	Specification (TD)			Before change	After change
		Min.	Max.	Unit	Avg.	Avg.
VUVLO-	VO < 5V	9.2	11.1	V	10.06	10.05
IFLH	VCC2=30V, VO < 5V	-	6	mA	2.62	2.15
tpLH	IF=0→10mA, VCC2=20V, Rg=10Ω, Cg=25nF	50	150	ns	120.2	112.5
tpHL	IF=10→0mA, VCC2=20V, Rg=10Ω, Cg=25nF	50	150	ns	100.3	101.4
tpHL-tpLH	IF=0↔10mA, VCC2=20V, Rg=10Ω, Cg=25nF	-	50	ns	20.0	11.1
tDESAT(90%)	CDESAT=100pF, VCC1=5V, VCC2=30V, Rg=10Ω, RF=2.1kΩ, CG=25nF	-	500	ns	137.1	136.7
tDESAT(10%)	CDESAT=100pF, VCC1=5V, VCC2=30V, Rg=10Ω, RF=2.1kΩ, CG=25nF	-	8.5	μs	4.49	4.31
tDESAT(FAULT)	CDESAT=100pF, VCC1=5V, VCC2=30V, Rg=10Ω, RF=2.1kΩ	-	550	ns	188.1	166.9
tRESET(FAULT)	CDESAT=100pF, VCC1=5.5V, VCC2=30V, Rg=10Ω, RF=2.1kΩ	0.2	2	μs	0.61	0.63

\*Cpks were more than 1.33 in all items

# TLP5214A Initial characteristics distribution check

No significant differences were observed before and after the change

**VF (IF=10mA)**

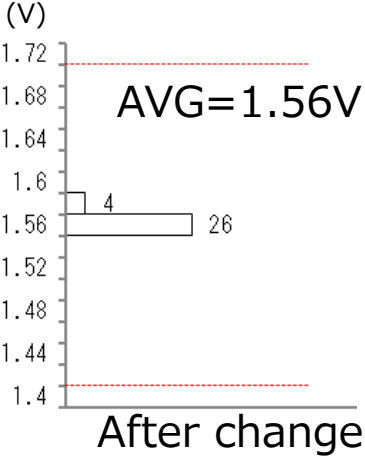
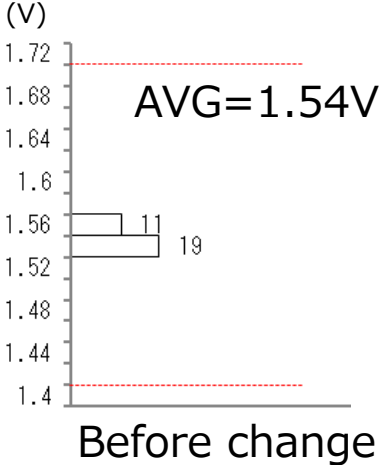

**IR (VR=5V)**

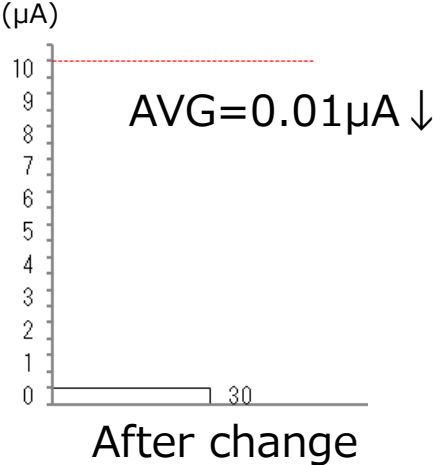
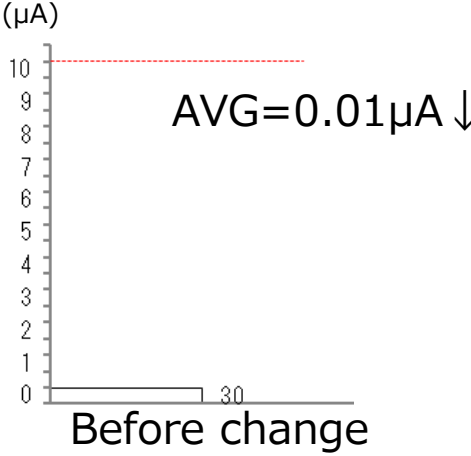

**VFAULTL (IFault=1.1mA, VCC1=5.5V)**

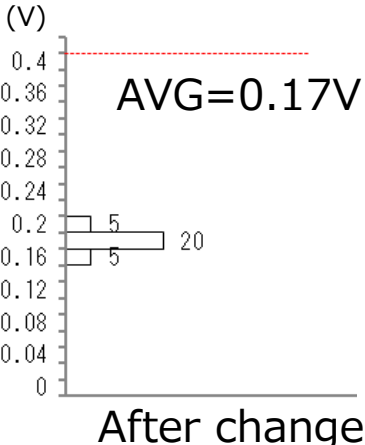
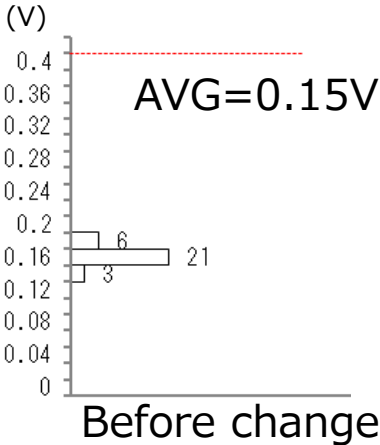

**VFAULTL (IFault=1.1mA, VCC1=3.3V)**

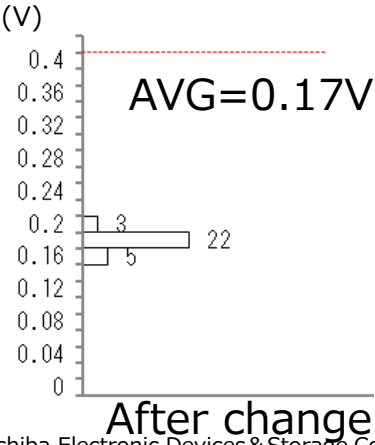
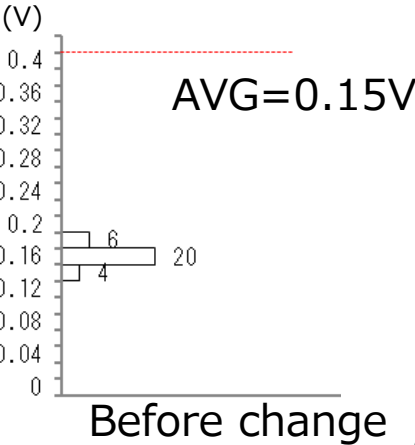

# TLP5214A Initial characteristics distribution check

No significant differences were observed before and after the change

**IFAULTH (VFAULT=5.5V, VCC1=5.5V)**

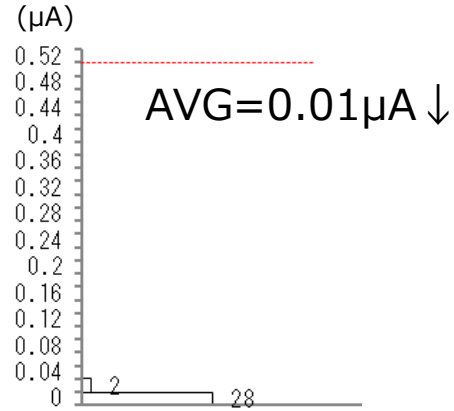

Before change

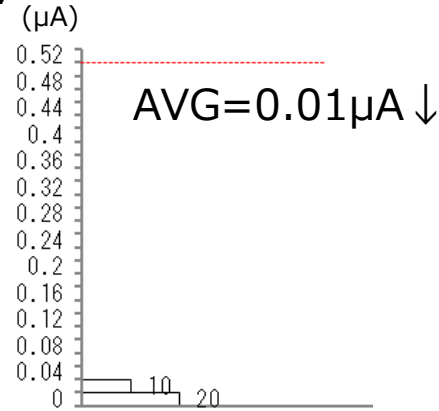

After change

**IFAULTH (VFAULT=5.5V, VCC1=3.3V)**

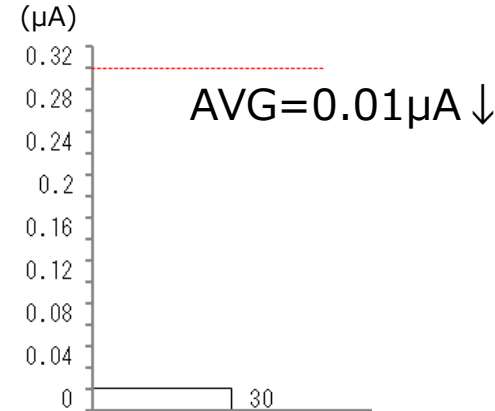

Before change

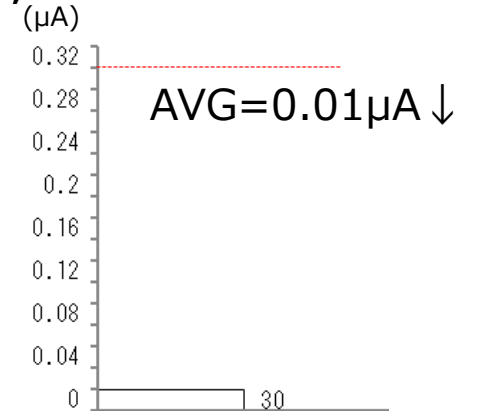

After change

**IOPH (VO=VCC2-4V, VCC2-VEE=15~30V)**

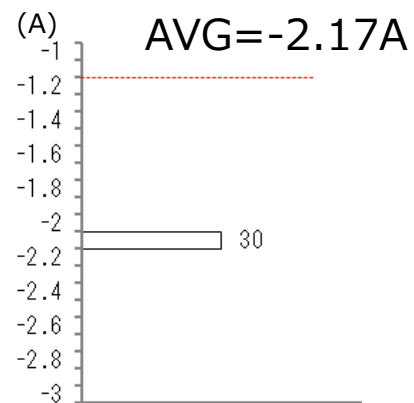

Before change

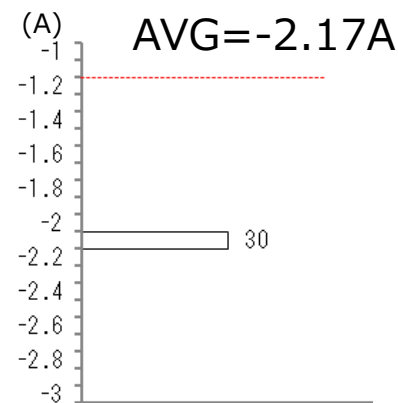

After change

**IOPH (VO=VCC2-7V, VCC2-VEE=15~30V)**

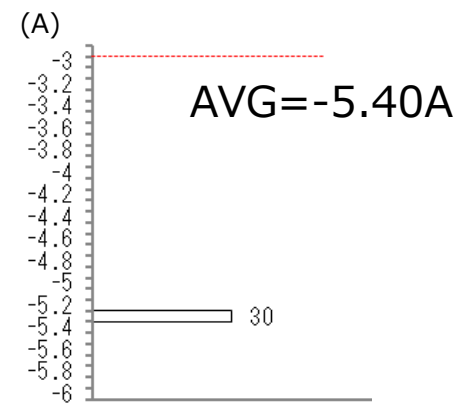

Before change

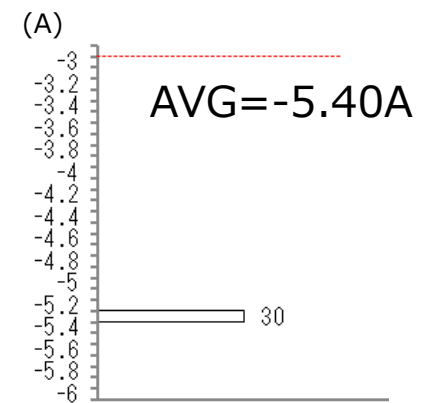

After change

# TLP5214A Initial characteristics distribution check

No significant differences were observed before and after the change

**IOPL (VO=VEE2+2.5V, VCC2-VEE=15~30V)**

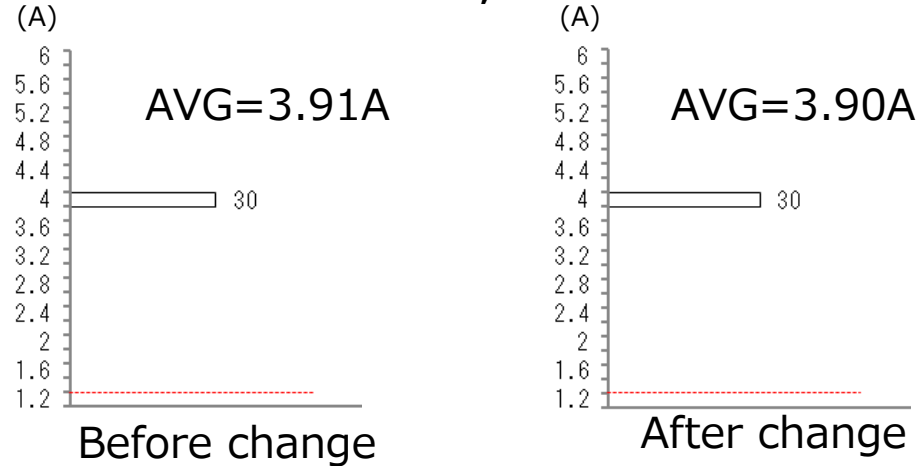

**IOPL (VO=VEE2+7V, VCC2-VEE=15~30V)**

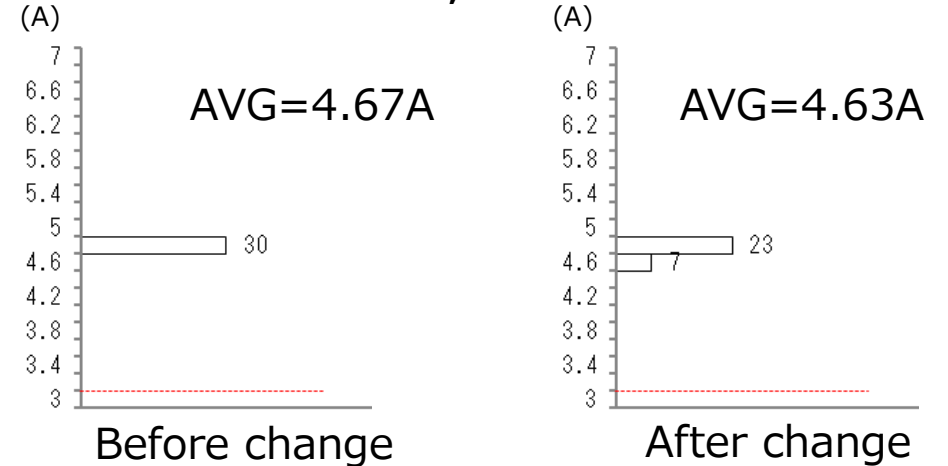

**IOLF (VO-VEE=14V, VCC2-VEE=15~30V)**

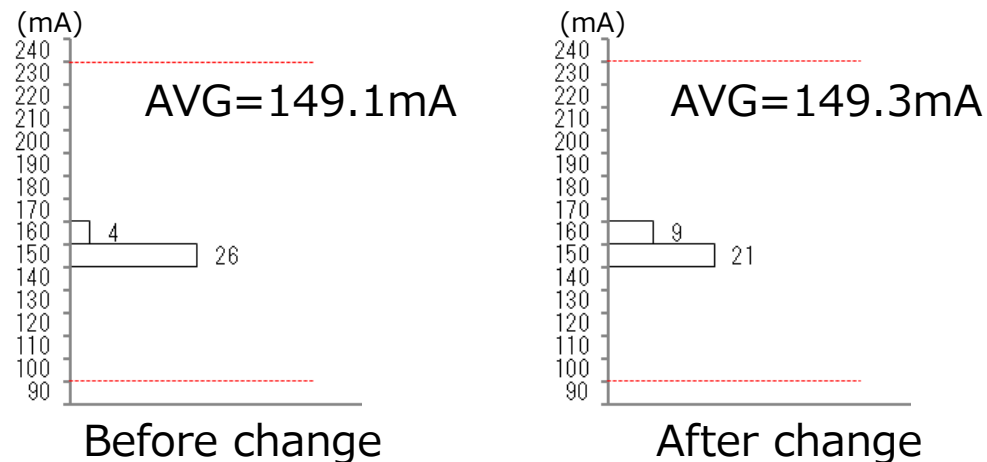

**VOH (IO=-100mA, VCC2=30V)**

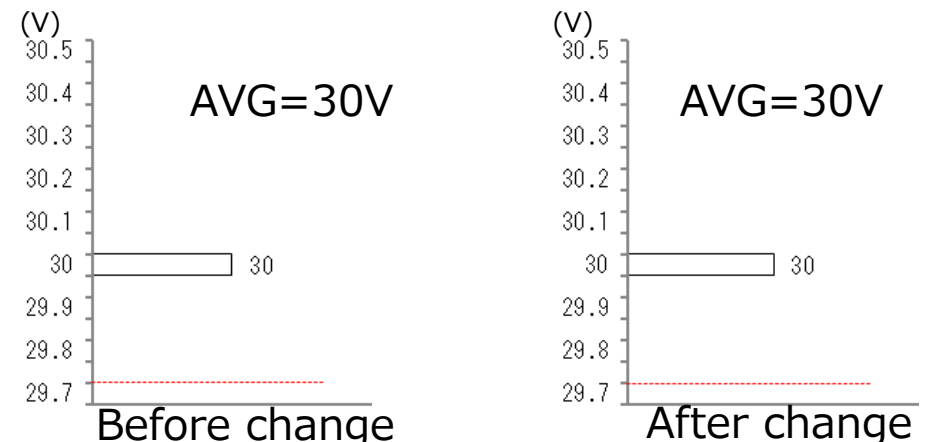

# TLP5214A Initial characteristics distribution check

No significant differences were observed before and after the change

**VOL** ( $I_O=100\text{mA}$ ,  $V_{CC2}-V_{EE}=15\sim 30\text{V}$ )

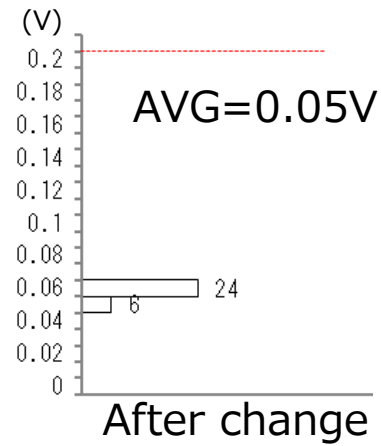
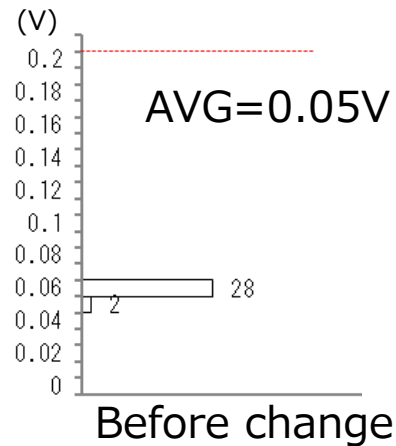

**ICL** ( $V_O=V_{EE}+2.5\text{V}$ ,  $V_{CC2}-V_{EE}=15\sim 30\text{V}$ )

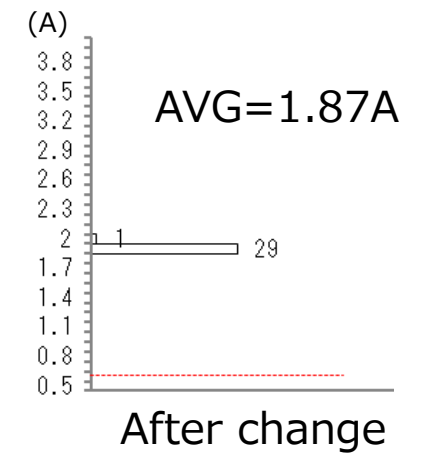
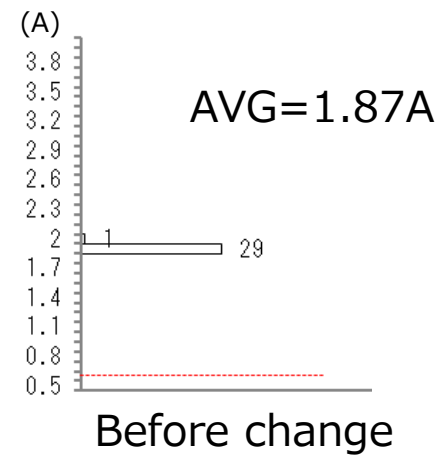

**ICC2H** ( $I_O=0\text{mA}$ ,  $V_{CC2}-V_{EE}=15\sim 30\text{V}$ )

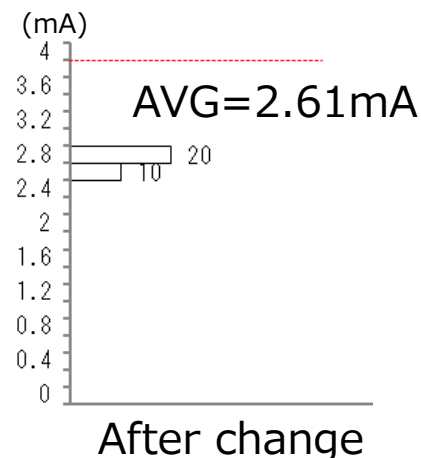
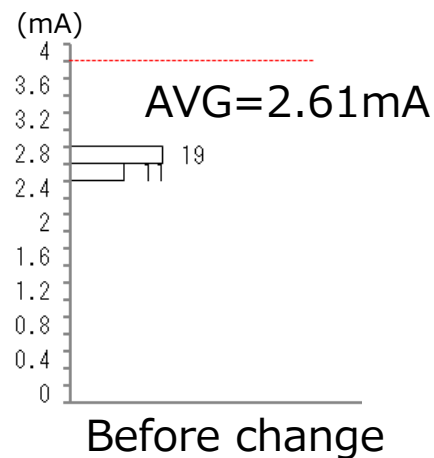

**ICC2L** ( $I_O=0\text{mA}$ ,  $V_{CC2}-V_{EE}=15\sim 30\text{V}$ )

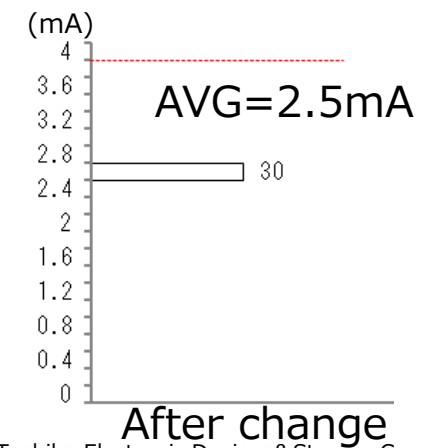
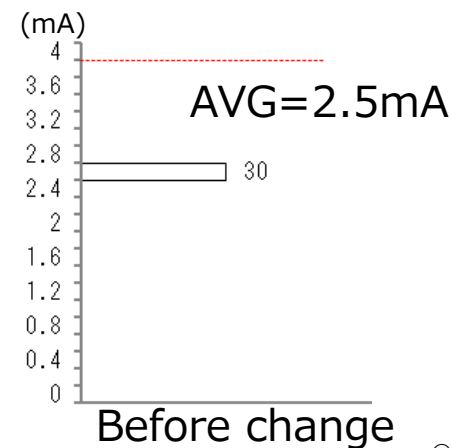

# TLP5214A Initial characteristics distribution check

No significant differences were observed before and after the change

## ICHG (VDESAT=2V)

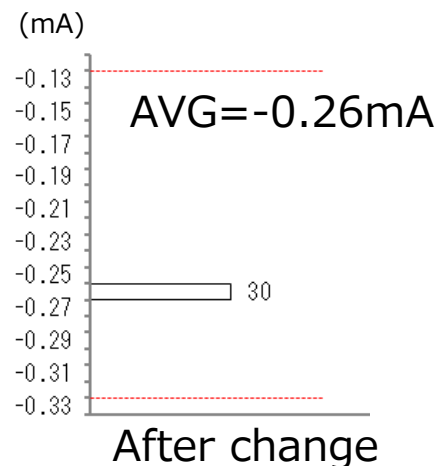
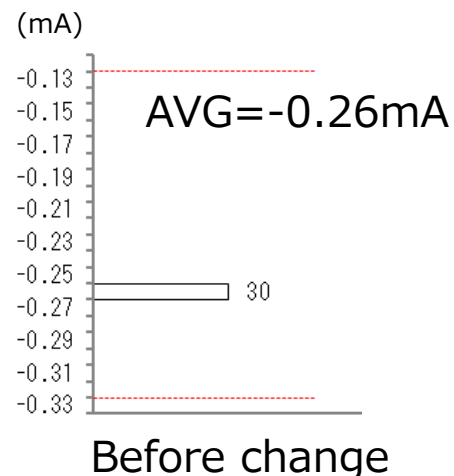

## IDSCHG (VDESAT=7V)

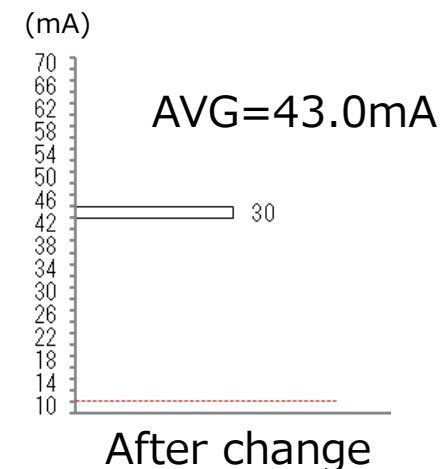
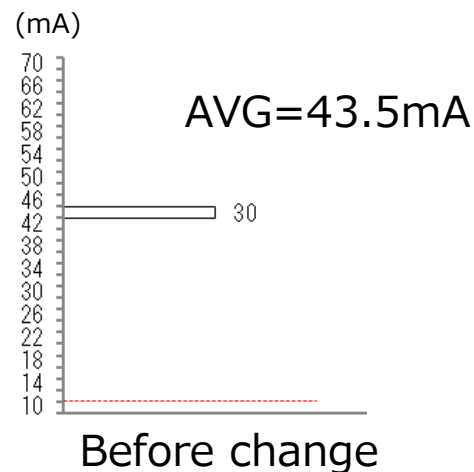

## VDESAT (VCC2-VE > VUVLO-)

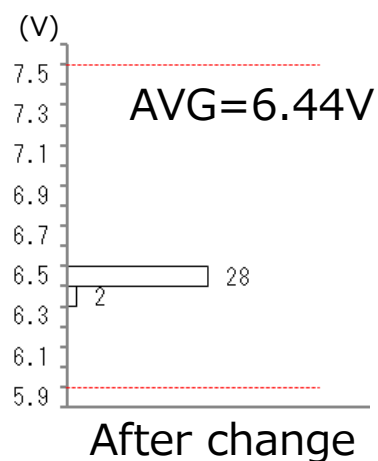
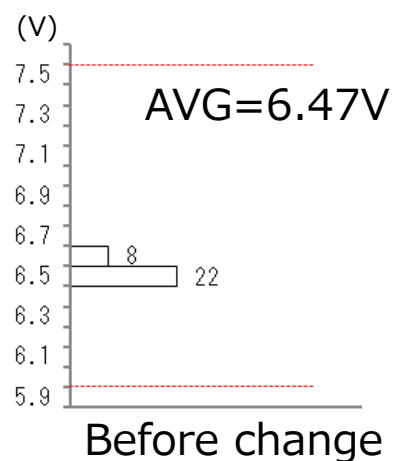

## VUVLO+ (VO > 5V)

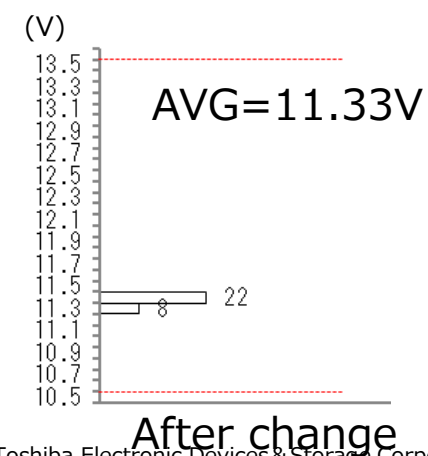
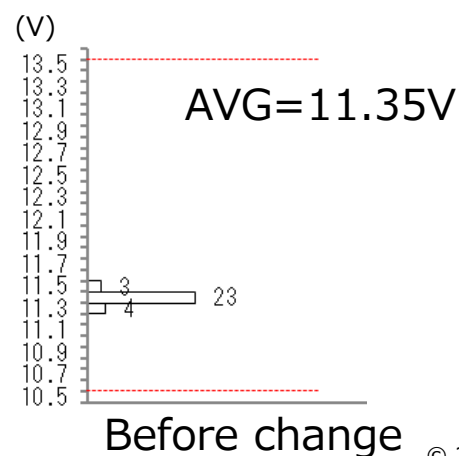

# TLP5214A Initial characteristics distribution check

No significant differences were observed before and after the change

### VUVLO- ( $V_O < 5V$ )

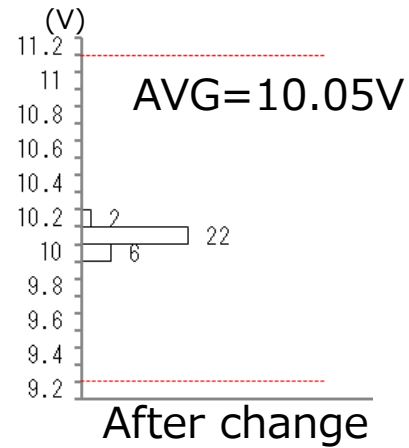
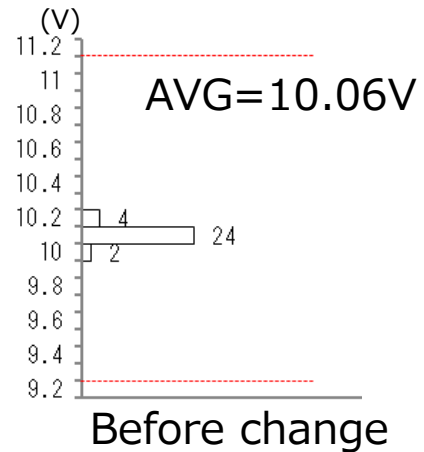

### IFLH ( $V_{CC2}=30V, V_O < 5V$ )

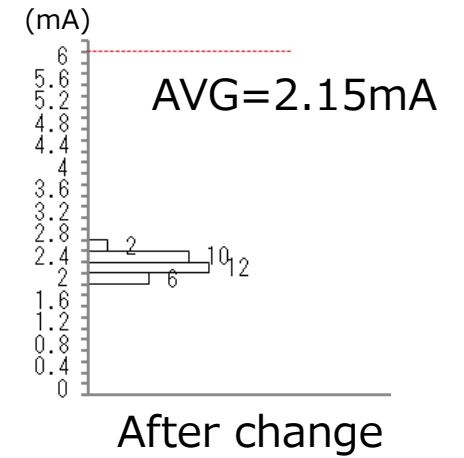
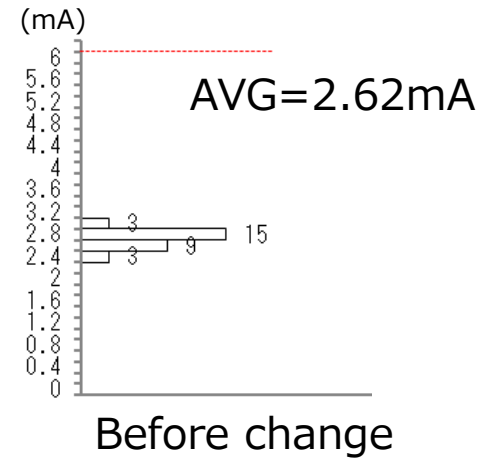

### tpLH ( $I_F=0 \rightarrow 10mA, V_{CC2}=20V, R_g=10\Omega, C_g=25nF$ )

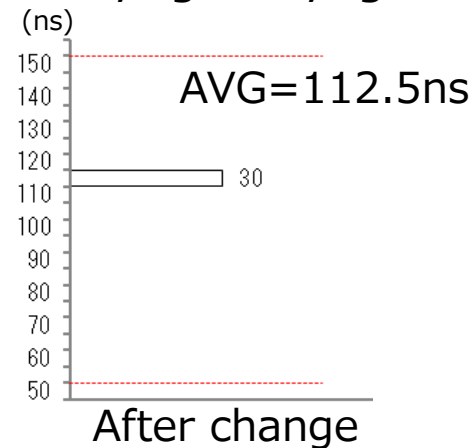
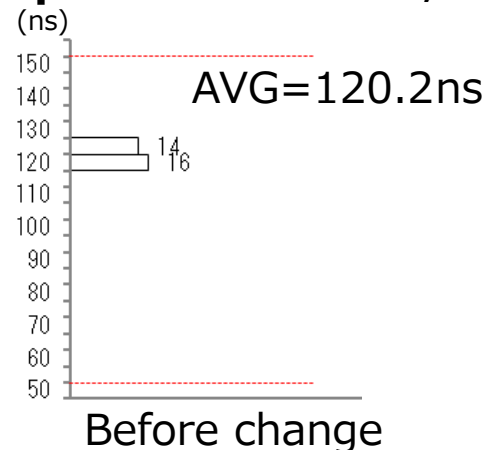

### tpHL ( $I_F=10 \rightarrow 0mA, V_{CC2}=20V, R_g=10\Omega, C_g=25nF$ )

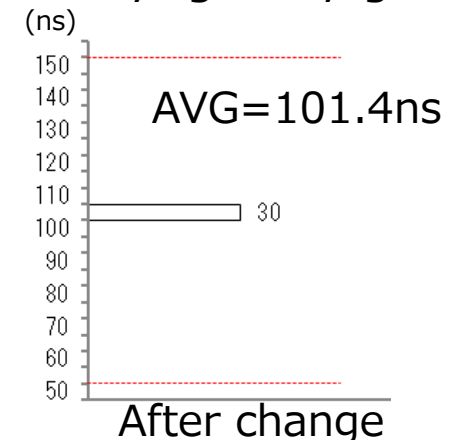
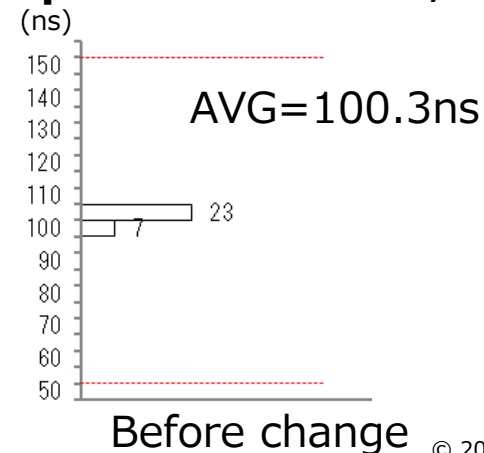

# TLP5214A Initial characteristics distribution check

No significant differences were observed before and after the change

**|tpHL-tpLH|** (IF=0↔10mA, VCC2=20V, Rg=10Ω, Cg=25nF)

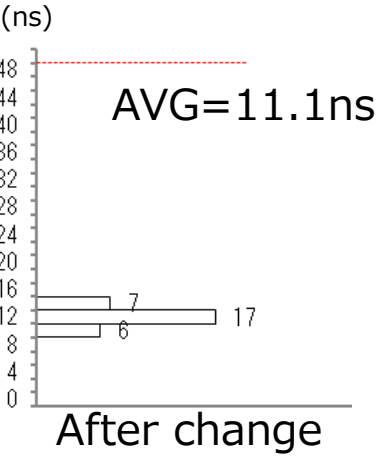
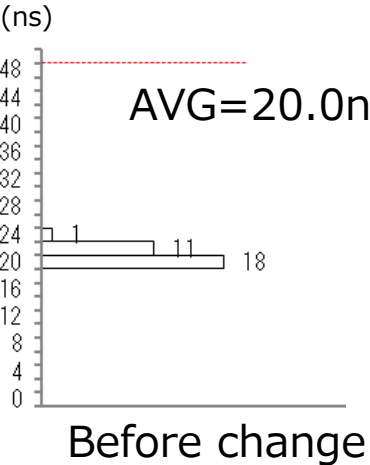

**tDESAT90%** (CDESAT=100pF, VCC1=5V, VCC2=30V, Rg=10Ω, RF=2.1kΩ, CG=25nF)

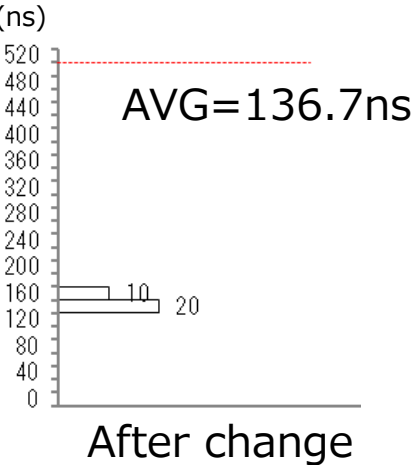
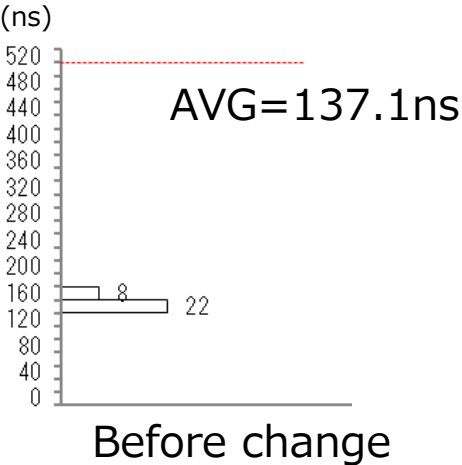

**tDESAT10%** (CDESAT=100pF, VCC1=5V, VCC2=30V, Rg=10Ω, RF=2.1kΩ, CG=25nF)

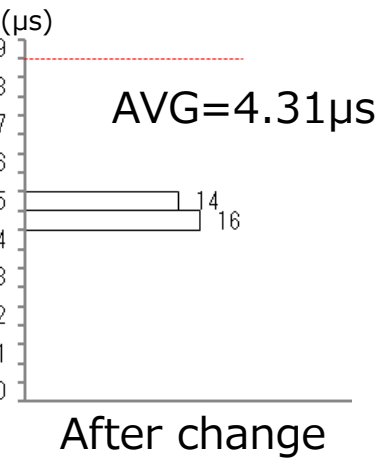
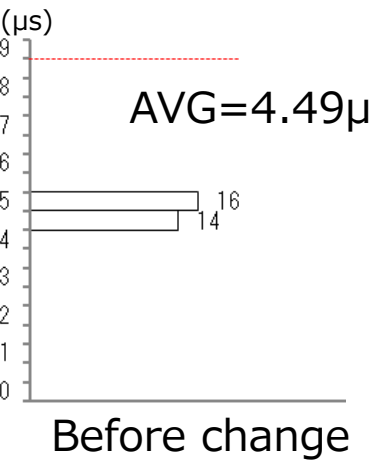

**tDESAT(FAULT)** (CDESAT=100pF, VCC1=5V, VCC2=30V, Rg=10Ω, RF=2.1kΩ)

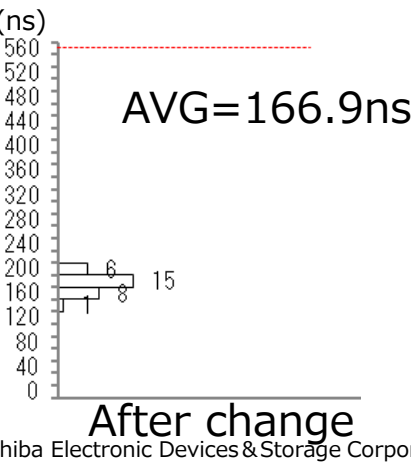
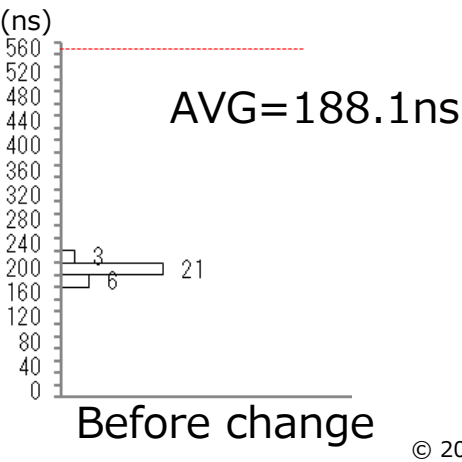



# TLP5214A Initial characteristics distribution check

No significant differences were observed before and after the change

**tRESET(FAULT)** (CDESAT=100pF, VCC1=5.5V, VCC2=30V, Rg=10Ω, RF=2.1kΩ)

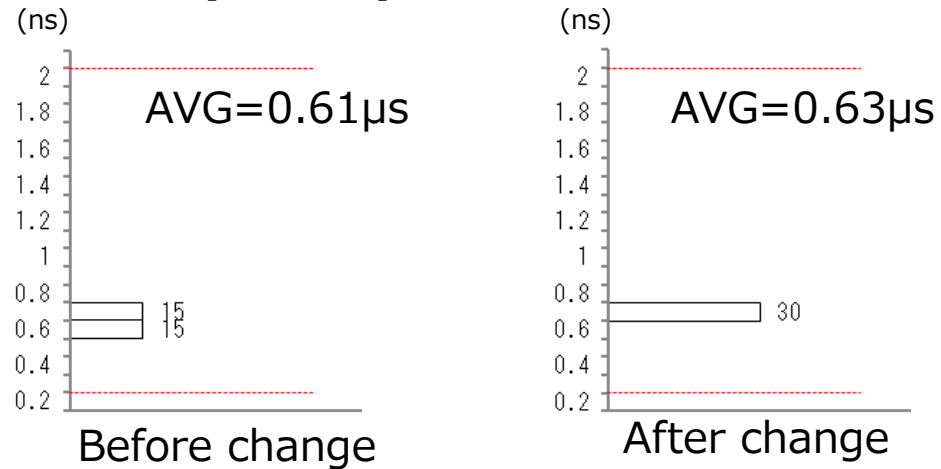

# TLP5214A Temperature characteristics check

Confidential

Characteristics fluctuation tendencies depending on the temperature change are almost equivalent

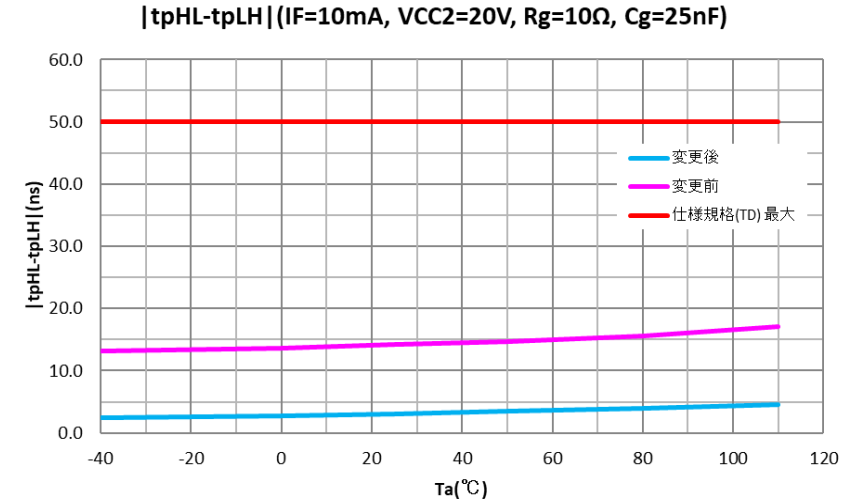
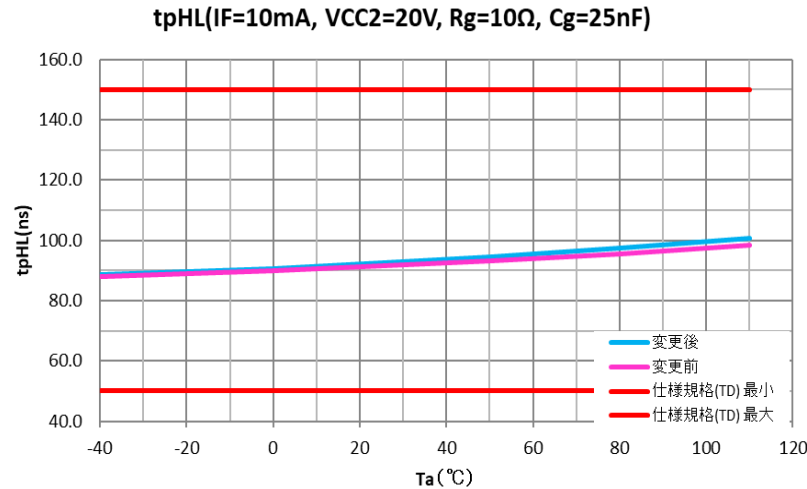
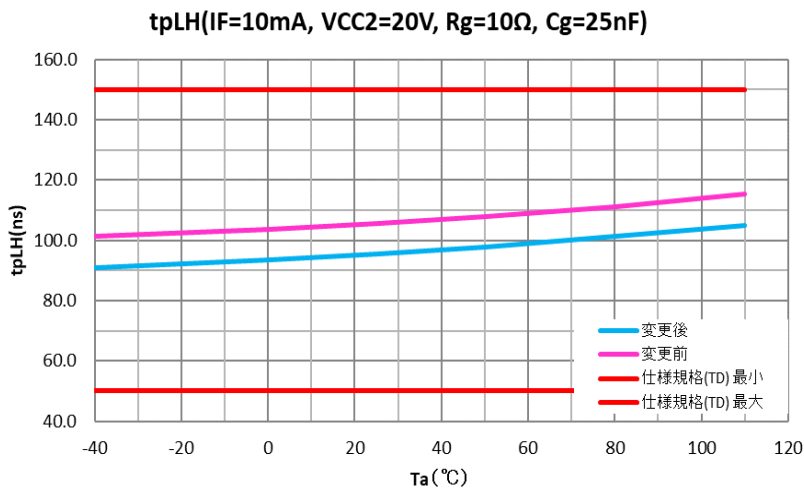
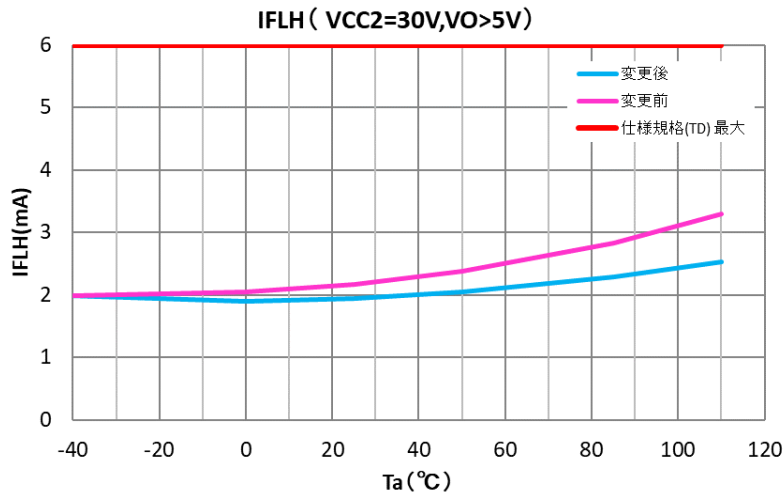

No failures occurred in each test item before and after the change, which confirmed the equivalent level.

Before change : n=30pcs  
After change : n=30pcs

No.	Reliability test item	Test condition	Judgement (Failed Q'ty/Tested Q'ty)		
			Test time	Before change	After change
1	High temperature operating test (HTO)	Ta=110°C, IF=10mA, IO=±4A, VCC2-(VE-VEE)=30V, VE=VEE=GND	1000h	0/30	0/30
2	Temperature cycling test (TCT)	-55°C (30min.) to 125°C (30min.)	300cyc	0/30	0/30
3	Pressure cooker test (PCT)	Ta=121°C, 203kPa (unsaturated)	96h	0/30	0/30

- Pre-treatment (moisture absorption + reflow) was conducted before testing all of the items above.

**TOSHIBA**