

Not Recommended for New Designs: AHF2 (TiP) Fall Detection Switches

Product Group #: E0002

DATE: 04.09.2026

About This Notice:	<p>To our valued customers:</p> <p>The following Panasonic Industry part numbers are being marked as Not Recommended for New Designs (NRFND). We understand that this may cause some inconvenience, however, if we have recommended alternatives, please reference the attached documents or contact us directly. We appreciate your business and look forward to continuing to serve your needs.</p>
Features:	<p>This product will no longer be promoted for new designs due to the deterioration of profits caused by rising raw materials, labor costs, and aging facilities.</p>
Effective Date:	<p>IMMEDIATE</p>
Affected Part(s) and/or Replacement(s):	<p>See attached Affected Parts List or contact Panasonic for more information.</p>
Datasheet(s):	<p>See attached Datasheet(s).</p>
Notes:	

 **Not Recommended for New Design**
Affected Products: All Types
Effective Date: From February 1, 2026

For detection: Fall Detection Switches **AHF2 (TiP) Switches**

Product Catalog

**IN Your
Future**

AHF2 (TiP) Switches

! Not Recommended for New Design
 Affected Products: All Types
 Effective Date: From February 1, 2026

Small, Highly reliable Tilt Detection Switches Containing a Photo Sensor

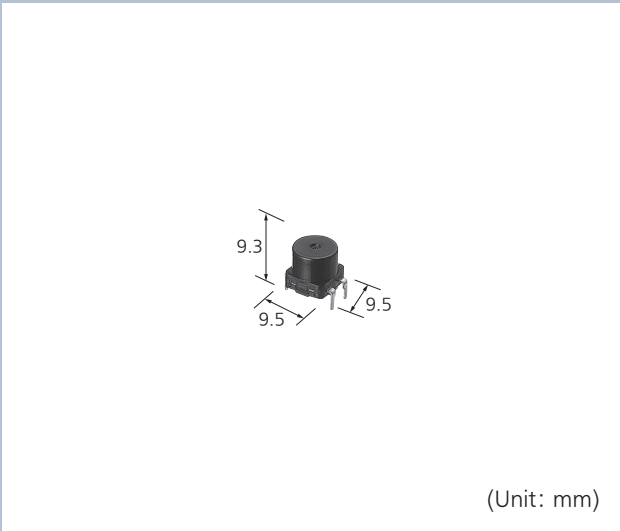

FEATURES

- Non-contact type switch containing a photo sensor
- The contact form is equivalent to SPST-NC, which satisfies the PL Act.
- The internal sphere can be used over an operation angle of 360 degrees in the circumferential direction.
- There are three standard terminal types

TYPICAL APPLICATIONS

- Fan heaters
- Warm water washing toilet seat
- Electric jar pot
- 24-hour circulation bath

TYPES

Mounting direction	Vertical mounting	Horizontal mounting	Reverse mounting
Part No.	AHF21	AHF22	AHF23
PC board mounting condition			

Note) Standard Packaging: Tube 50 pcs.

BASIC CHARACTERISTICS

■ For Ta = 25 °C and applicable circuit conditions

- 1) Operation characteristics
 (Operation speed 6 degrees/second)
 - Operation angle (Output: $V_{OL} \rightarrow V_{OH}$) : 25 to 60 degrees
 - Return angle (Output: $V_{OH} \rightarrow V_{OL}$) : Min. 20 degrees

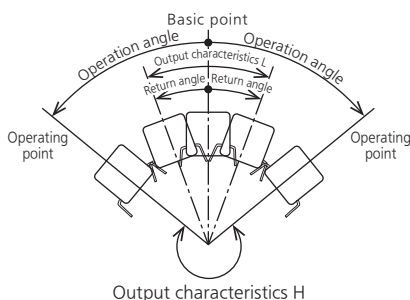

- 2) Output (V_o) characteristics
 (The sphere must be stationary.)
 - V_{OL} (photo transistor ON) : Max. 1.0 V (horizontal)
 - V_{OH} (photo transistor OFF) : Min. 4.0 V (inclined at an angle of at least 60 degrees)

Note) Output characteristics are the values of the applied circuit conditions, below. Also, the microcomputer input terminals actually used use the following voltages.

- Low level input terminal: 1.5 V or less
 - High level input terminal: 3.5 V or higher
- Please use with a detection method to prevent malfunction.
 Refer to the " Preventing a malfunction " of " CAUTIONS FOR USE " .

INTERNAL AND APPLICABLE CIRCUIT

- $V_{CC} = 5\text{ V}$
- $R_2 = 100\text{ k}\Omega$
- Forward current, I_F , of the LED: 19 mA ($V_{CC} = 5\text{ V}$, $R_1 = 200\ \Omega$)
 Forward voltage, V_F , of the LED: Typ. = 1.2 V
 Please set the power supply voltage (V_{CC}) and circuit resistance (R_1 and R_2) to within $\pm 5\%$

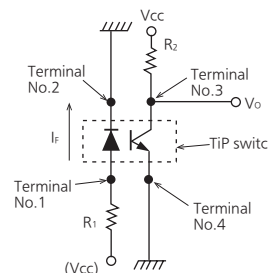

RATING

Absolute maximum rating

$T_a = 25\text{ }^\circ\text{C}$

Item	Symbol	Rating	Unit	
Input side Infrared light emitting diode (between terminal No.1 and No.2)	Forward Current	I_F	50	mA
	Reverse Voltage	V_R	5	V
	Power Dissipation	P_o	75	mW
Output side Phototransistor (between terminal No.3 and No.4)	Collector-Emitter Voltage	V_{CEO}	30	V
	Emitter-Collector Voltage	V_{ECO}	3	V
	Collector Current	I_c	20	mA
	Collector Power Dissipation	P_c	50	mW

Specifications

Item	Specifications
Electrical and mechanical expected life	Min. 10^5 (Using the applicable circuit) Switching frequency: 6 cpm; Opening and closing position: 0 degrees ↔ 90 degrees (The internal sphere must be stationary for at least 500 ms at angles of 0 and 90 degrees respectively.)
Vibration resistance	10 to 400 Hz acceleration 2.9 m/s^2 applied for 7 days 5 to 10 Hz at single amplitude of 5 mm, 5×10^5 cycles
Shock resistance	588 m/s^2 applied 3 times in each of 6 directions
Terminal strength	Min. 9.8 N (each direction)
Dropping individual part	Three times from height of 100 cm
High temperature, high humidity storage ability	Leave for 500 hours at $85\text{ }^\circ\text{C}$ and 85 % RH (no condensing)
High temperature storage ability	Leave for 500 hours at $85\text{ }^\circ\text{C}$
Low temperature storage ability	Leave for 500 hours at $-25\text{ }^\circ\text{C}$ (no freezing)
Shock and heat resistance	Subject to 100 cycles each consisting of 30 minutes at $-25\text{ }^\circ\text{C}$ and 30 minutes at $85\text{ }^\circ\text{C}$
Resistance to hydrogen sulfide	Leave for 500 hours in an atmosphere containing 3 ppm of hydrogen sulfide at $40\text{ }^\circ\text{C}$ and 75 % RH
Resistance to sulfur dioxide gas	Leave for 500 hours in an atmosphere containing 10 ppm of sulfur dioxide at $40\text{ }^\circ\text{C}$ and 95 % RH
Resistance to ammonia gas	Leave for 96 hours in an atmosphere containing 3 % of ammonia gas at normal temperature and humidity
Resistance to dust	Mix with 2 kg/m^3 talcum powder or fly ash and leave to stand for 8 hours
Ambient temperature	-20 to $+80\text{ }^\circ\text{C}$ (no freezing and condensing)
Unit weight	Approx. 1 g
Protection grade	IP40

- Notes) 1: Without any indications, specifications are measured at following conditions
 Temperature: 15 to $35\text{ }^\circ\text{C}$, Humidity: 25 to 85 % RH, Atmospheric pressure: 86 to 106 kPa.
 2: The evaluation criteria for performance are as follows:
 Basic characteristics: $T_a = 25\text{ }^\circ\text{C}$ and applicable circuit conditions
 1) Operation characteristics (operation speed 6 degrees/sec)
 • Operation angle (Output: $V_{OL} \rightarrow V_{OH}$) : 25 to 60 degrees
 • Return angle (Output: $V_{OH} \rightarrow V_{OL}$) : Min. 20 degrees
 2) Output (V_o) characteristics (The sphere must be stationary.)
 • V_{OL} (photo transistor ON) : Max. 1.2 V (horizontal)
 • V_{OH} (photo transistor OFF) : Min. 3.8 V (inclined at an angle of at least 60 degrees)

CONTACT FORM

SPST-NC (The photo transistor is ON when the sensor is being used.)

DIMENSIONS (Unit: mm)

CAD The CAD data of the products with a " CAD " mark can be downloaded from our Website.

Horizontal mounting type

CAD

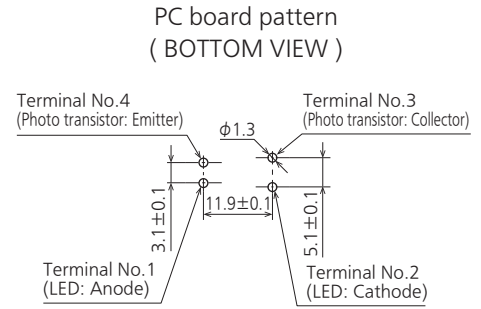
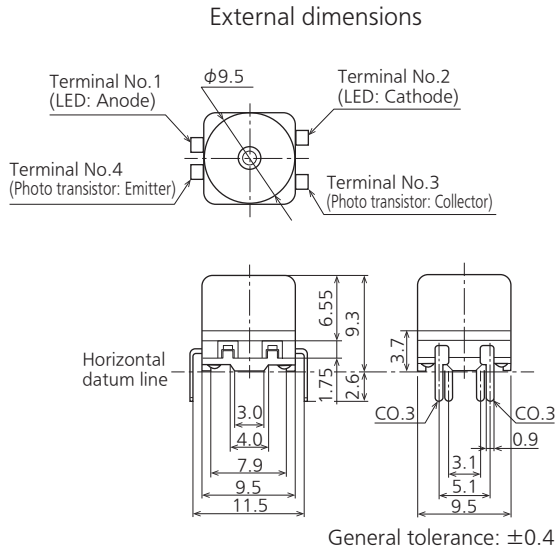

Vertical mounting type

CAD

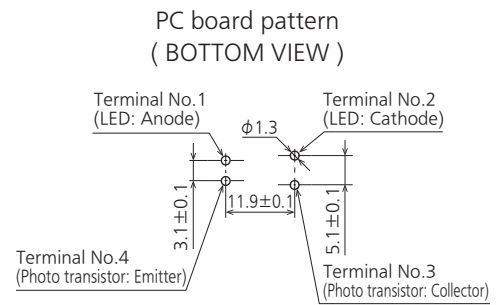
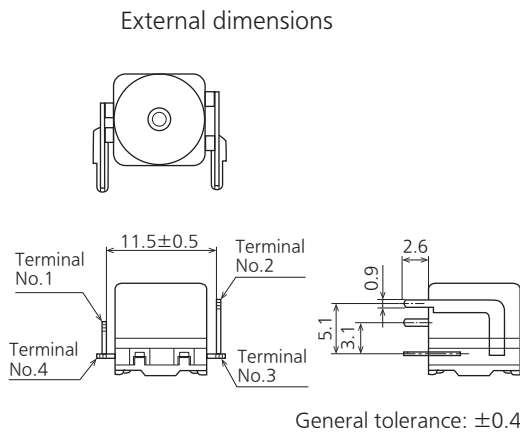

Reverse mounting type

CAD

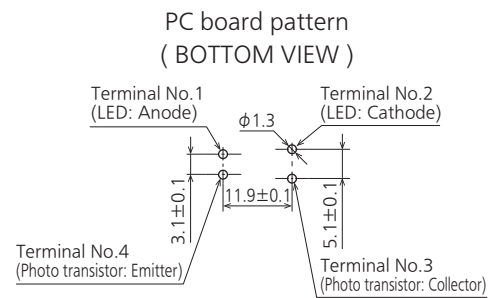
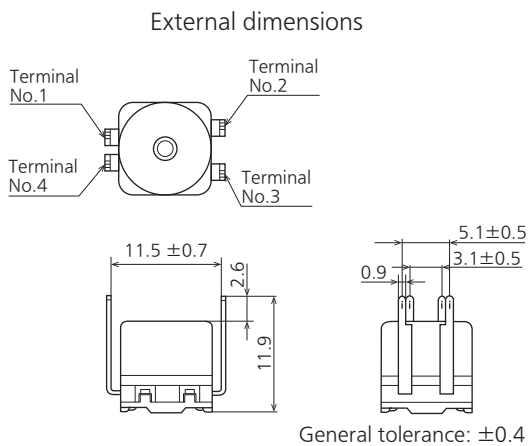

GUIDELINES FOR USAGE

■ Handling

As indicated on the previous page, the absolute maximum rating of the built-in photo-interrupter is 25 °C.

In the event that a voltage or current that exceeds the maximum rating is applied to, or passed between the terminals, the photo-interrupter will no longer function normally. In such a case, do not reuse the photo-interrupter but discard it.

Be careful not to apply an excessively large load to the terminals because this may damage the photo-interrupter.

■ Soldering

Perform soldering in less than 3 seconds with maximum 350 °C iron. Care should be taken not to apply force to the terminals during soldering. We recommend a soldering iron with temperature adjustment in order to prevent poor quality soldering.

Please consult us if you intend to use a soldering iron of 60 W or higher.

■ Environment

This product is a non-contact type tip detection switch containing a photo-interrupter.

It is intended for installation in equipment. Because of the nature of a semiconductor, if this product is used continuously for a long period in a high temperature, low temperature and/or humid environment, according to the optic quantities decrease of luminescent diode output characteristics may be significantly affected. In such a case, take suitable measures, such as inserting a comparator at the output side, to provide a greater degree of margin with respect to change in the output characteristics, and thereby improve the reliability of the product.

Also, since it is not a sealed type (waterproof construction), please provide a sealed construction for the entire product if it will be used in a place where water might get splashed on it or in an environment with the possibility of condensation.

Also, if sealing with a sealant for PC boards, please make sure to evaluate and confirm that no sealant enters the inside of the unit.

■ Preventing a malfunction

The TiP sensor uses an internal sphere, hence chattering occurs if it is subjected to vibration or shock. To prevent chattering, continuously read pulses of 30 ms max. using a microprocessor, and set the microprocessor so that the switch goes L (ON) or H (OFF) if the output level exceeds 500 ms continuously. Also, take steps to keep induction and RF noise away from the sensor. The switch should be mounted keeping away from the vibration generator such as motor. Fix the PC board firmly in order to prevent resonance with the vibration generator, or the contact chattering of a switch may occur by the movement of a ball inside.

The allowable vibration level which the chattering does not occur would be less than 2.94 m/s² at 10 to 400 Hz. (The range 260 to 320 Hz may have a resonance point and the level should be less than 0.98 m/s².)

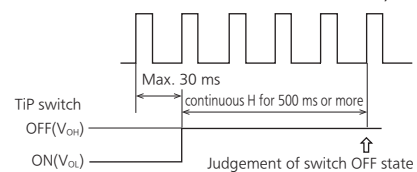

■ Others

- 1) Depending on usage conditions and environment, solder migration may occur and short a circuit. Please confirm that the insulation distance is large enough in the actual application.
- 2) To prevent a malfunction, the switch should be kept away from the direct sunlight and any other light sources.
- 3) The noises caused by electrostatics, surge voltage and inductives may break the photo-interrupter.
- 4) The reflow soldering and cleaning are not allowed.
- 5) The switch should be mounted with the tolerance ±3 degree.

■ Confirmations in the actual use.

Each item in this spec sheet was tested and confirmed independently at a certain duration. To get a higher reliability of the equipment, please confirm the switch quality with the actual load and environmental conditions before using.

Please refer to " **the latest product specifications** " when designing your product.

• Requests to customers:

<https://industry.panasonic.com/global/en/salespolicies>

Technical Terminology & Cautions for Use (Detection Switches)

TECHNICAL TERMINOLOGY

■ Detection Switches

A compact switch equipped with an enclosed micro-gap snap-action contact mechanism that makes a specified motion with a specified force to open/close a circuit, and an actuator outside the enclosure (hereinafter referred to as the switch)

■ Actuator

A part of the switch that transmits the received external force to an internal spring mechanism to move the movable contact so that the switch can be opened and closed

■ Actuator stopper

A part of the switch to limit the actuator movement in the switch operation direction

■ Rated values

Values indicating the characteristics and performance guarantee standards of the snap-action switches. The rated current and rated voltage, for instance, assume specific conditions (type of load, current, voltage, frequency, etc.) .

■ Mechanical life



The service life when operated at a preset operating frequency without passing electricity through the contacts. (The life test is performed at a switching frequency of 60 times/minute and operating speed of 100 mm/second at the regular cam.)

■ Electrical life

The service life when the rated load is connected to the contact and switching operations are performed. (The life test is performed at a switching frequency of 20 times/minute and operating speed of 100 mm/second at the regular cam.)

■ Contact form

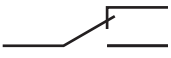
This refers to the components determining the type of application which make up the electrical input/output circuits in the contact.

SPDT	
SPST-N.C.	
SPST-N.O.	

■ Insulation resistance

Resistance between non-continuous terminals, each terminal and other exposed metal parts and between each terminal and ground.

■ Dielectric

Threshold limit value that a high voltage can be applied to a predetermined measuring location for one minute without causing damage to the insulation.

■ Contact resistance

This indicates the electrical resistance at the contact part. Generally, this resistance includes the conductor resistance of the spring and terminal portions.

■ Vibration resistance

Malfunction vibration ... Vibration range where a closed contact does not open for longer than a specified time due to vibrations during use of the snap-action switches.

■ Shock resistance

Shock durability ... Shock range where the mechanical shocks received during snap-action switches transport and installation do not damage the parts or harm the operating characteristics.

Malfunction shock ... Shock range where a closed contact does not open for longer than a specified time due to shocks during use of the snap-action switches.

Technical Terminology & Cautions for Use (Detection Switches)

TECHNICAL TERMINOLOGY

■ Definition of operating characteristic

The main terminological illustrations and meanings which are used with snap-action switches are as follows.

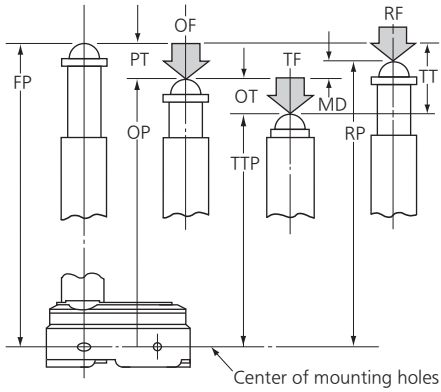

Classification	Terminology	Symbol	Unit	Varying display method	Starting current
Force	Operating Force	OF	N	Max.	The force required to cause contact snap-action. It is expressed terms of force applied to the actuator.
	Release Force	RF	N	Min.	The force to be applied to the actuator at the moment contact snaps back from operated position to total travel position.
	Total travel Force	TF	N		Force applied to an actuator required to move from an operating position to a total travel position
Movement	Pretravel	PT	mm, degree	Max.	Distance or degree of the actuator movement from free position to operating position.
	Over travel	OT	mm, degree	Min.	The distance or degree which the actuator is permitted to travel after actuation without any damage to the switching mechanism.
	Movement Differential	MD	mm, degree	Max.	The distance or degree from operating position to release position of the actuator.
	Total travel	TT	mm, degree		The migration length or the move angle from the free position to total travel position of actuator
Position	Free Position	FP	mm, degree		Position of the actuator when no force is applied to.
	Operating Position	OP	mm, degree	±	The position of the actuator when the traveling contacts snaps with the fixed contact.
	Release Position	RP	mm, degree		The position of the actuator when the traveling contacts snaps back from operating position to its original position.
	Total travel Position	TTP	mm, degree		The stopping position of the actuator after total travel.

TECHNICAL NOTES ON MECHANICAL CHARACTERISTICS

■ Actuation Force and Stroke

Adequate stroke setting is the key to high reliability. It is also important that adequate contact force be maintained to ensure high reliability. For a normally closed (N.C.) circuit, the driving mechanism should be set so that the actuator is normally in the free position. For a normally open (N.O.) circuit, the actuator should be pressed to 70 % to 100 % of the specified stroke to absorb possible errors.

If the stroke is set too close to the operating point (OP), this may cause unstable contact, and in the worst case may cause actuator damage due to inertia of the drive mechanism. It is advisable that the stroke be adjusted with the mounting plate or driving mechanism.

The figure at right shows a typical example of activation and contact forces varying with stroke. In the vicinity of the OP and RP, the contact force is diminished, causing chatter and contact bounce immediately before or after reversal. For this reason, use the switch while giving due consideration to this. This also causes the snap action switch to be sensitive to vibration or shock.

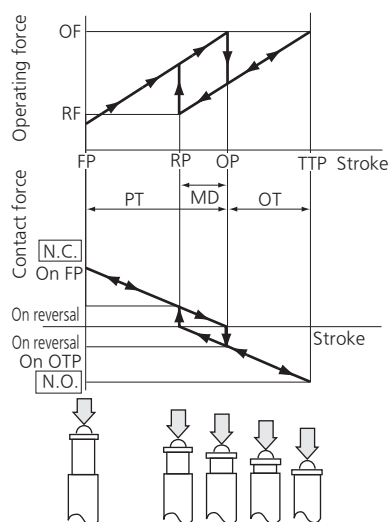

■ Changes in Operating Characteristics

Exercise design care so that malfunctions will not occur if the operating characteristics vary by as much as 20 % from rated values.

< Example >

In the OF Max. 0.98 N specification for FS snap-action switches,

the allowable Max. is $0.98 \text{ N} (100 \% + 20 \%) = 1.18 \text{ N}$

In the RF Min. 0.15 N Min. specification,

the allowable Min. is $0.15 \text{ N} (100 \% - 20 \%) = 0.12 \text{ N}$

■ Mechanical Conditions for Type Selection

Actuator type should be selected according to activation method, activation speed, activation rate, and activation frequency.

- 1) An extremely slow activation speed may cause unstable contact transfer, possibly resulting in contact failures or contact fusion.
- 2) An extremely high activation speed may cause damage to contacts or contact response failure.

■ Driving Mechanism

Use of a driving mechanism which will cause physical impact to the actuator should be avoided.

< Example >

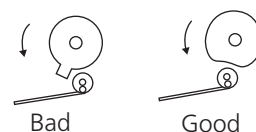

TECHNICAL NOTES ON ELECTRICAL CHARACTERISTICS

- 1) The snap-action switch is designed for AC operations. While it has small contact gaps and no arc absorber, it may be used for low-capacity DC operations. Please refer to the rating of each product
- 2) For applications with very small switching voltage or current, choose the low-level load type (Au contact).

Small current and voltage application range (Au contact)

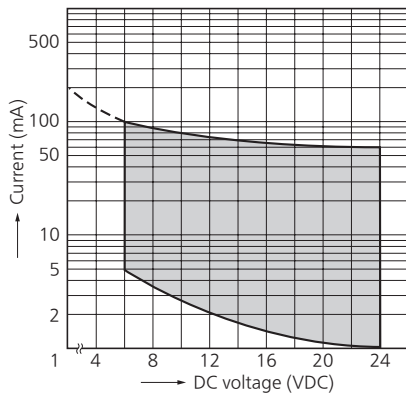

- 3) When selecting a contact type of a snap-action switch to be used for low-level load switching, the following should be noted.
Silver contacts' surfaces are prone to be oxidized and form a sulfide film. The switch operates with no problems at the beginning of use. However, as the contact surfaces develop films with time, the film may not be broken by the switching operation, causing a conduction failure. Therefore, please choose the Au contact type for switching a load of 0.1 A or below.
- 4) Application to Electronic Circuits
 - The snap-action switch contacts can sustain bounce or chatter when closed. Bounce or chatter can cause noise or pulse count errors when the snap action switch is used in electronic circuits.
 - If contact bounce or chatter poses problems in the vicinity of the OP and RP, use a suitable absorption network, such as a C/R network.
- 5) Check the surge current, normal current and surge duration.
- 6) Contact resistance given in performance specifications is measured with a voltage drop method using 6 to 8 V DC, 1 A (except for low-level load type). Contact resistance across COM and N.C. terminals is measured in the free position, while contact resistance across COM and N.O. terminals is measured in the total travel position.
- 7) To prevent contact welding failure, be sure to use a serial resistance for each capacitive load.
- 8) If snap-action switch operation is synchronized with the AC supply phase, this may cause: shortened electrical life, contact fusion failure, contact transfer, or other reliability problems.

Technical Terminology & Cautions for Use (Detection Switches)

CAUTIONS IN A CIRCUIT

1) Contact protection is recommended when snap-action switches are used in an inductive load circuit.

Circuit diagram	Cautions for use
<p>Contact for snap-action switch</p>	<p>(1) $r =$ more than 10Ω (2) In an AC circuit Impedance of R is to be slightly smaller than impedance of r and c.</p>
<p>Contact for snap-action switch</p>	<p>Can be used for both AC and DC. Impedance of r is nearly equal to impedance of R. C: $0.1 \mu\text{F}$</p>
<p>Contact for snap-action switch</p>	<p>(1) For DC circuits only.</p>
<p>Contact for snap-action switch</p>	<p>Can be used for both AC and DC.</p>

2) Do not connect the contacts on individual switches to different type or different poles of the power supply. Examples of power supply connections (connection to different poles)

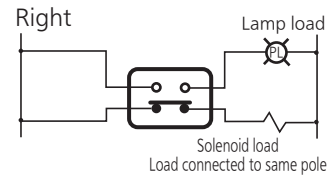
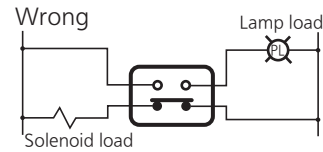

Example of wrong power supply connection (connection to different poles of power supply)
 This may lead to mixed DC and AC.

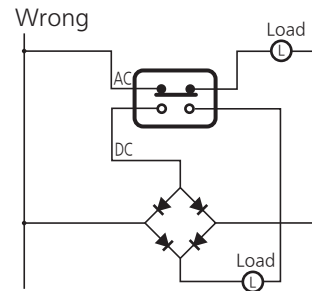

3) Avoid circuits which apply voltage between contacts. (This may lead to mixed deposition.)

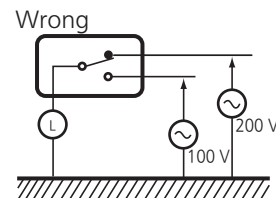

Technical Terminology & Cautions for Use (Detection Switches)

MOUNTING STATE AND ENVIRONMENT

■ Checking the insulation distance

After mounting and wiring, check the insulation distance between terminals and the ground. If the insulation distance is inadequate, mount insulating material between as required.

■ Fastening the snap-action switch body

See the Section " CAUTIONS FOR USE " for the individual switch.

■ Position adjustment with effector

- 1) The effector should be positioned so that direct force is not applied to the plunger or actuator in its free position. The operating force to the plunger should only be applied in a perpendicular direction.
- 2) Note that the use of the switch as a stopper may cause an operational problem.

■ Switch installation position

- Basically, the switch should be installed so that the object to press the switch's plunger or lever can press it down to 70 to 100 % of OT of the switch. When determining the position, the tolerance of OP (Operating Position) and other factors should be taken into account. The following describes the case where the strictest tolerance conditions are adopted.
- Example: Hinge lever type FS switch
Reference values: OP = 8.8 ± 0.8 mm
PT = Max. 2.8 mm
OT = Min. 1.2 mm

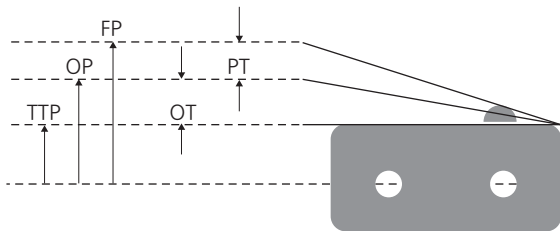

- ① When the switch is not pressed
The object to press the lever should not be in contact with the lever.
For this purpose, the object should be at a distance from the switch fater than the maximum FP (Free Position) value.
 $FP \text{ Max} = OP \text{ Max} + PT \text{ Max} = 9.6 + 2.8 = 12.4 \text{ mm Max}$
The object should be at a distance of 12.4 mm or more from the mounting hole.
- ② Depressed position
The plunger/lever should be pressed down to 70 % or more of OT (Over Travel). Therefore, the depressed position should be calculated based on the minimum value of OP (Operating Position) and the 70 and 100 % of the OT value.
 $OP \text{ Min} - 70 \% \text{ of OT} = 8.0 - 0.84 = 7.16 \text{ mm}$
 $OP \text{ Min} - 100 \% \text{ of OT} = 8.0 - 1.2 = 6.80 \text{ mm}$
The plunger/lever should be pressed down to the position of 6.80 to 7.16 mm from the mounting hole.

■ Soldering precautions

For manual soldering, lay the terminals flat (horizontal with the ground) and quickly perform the soldering operation using a soldering iron with the appropriate heat capacity and the proper amount of solder. Take care that the flux does not flow into the switch interior by using a ventilation fan to discharge flux gas and to prevent contact of the switch body with the soldering iron tip.
Be careful not to apply force to the lead wires or the terminal portions immediately after soldering.
The temperature setting and time conditions vary depending on the product.
See the section " CAUTIONS FOR USE " for each product.

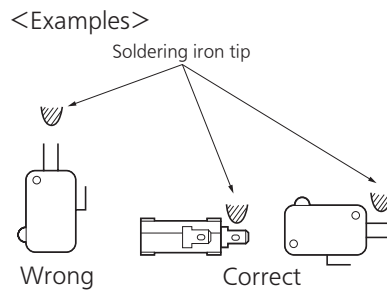

■ Avoid using in a silicon atmosphere*

Avoid using organic silicon rubber, adhesives, sealing compounds, oil, grease, and wires in a silicon atmosphere.

■ Please consult us when using under the following conditions*

- 1) Environments where hydrogen sulfide or other corrosive gases are present.
- 2) Environments where gasoline, thinner or other flammable, explosive gases are present.
- 3) Dusty environments (for non-seal type snap action switches).
- 4) The perpendicular operating speed exceeds the allowable operating speed.
- 5) Switching between different poles.
- 6) Use in environments not in the prescribed temperature or humidity range.

* Select contact sulfurization (clipping) prevention products (FS and Au-clad double layer contacts) for use with extremely small loads or an environment-resistant Turquoise switch.

■ Storage precautions

To prevent discoloration due to sulfurization of the terminals (silver-plated), store the switches in a polyethylene bag or other suitable airtight container.

Technical Terminology & Cautions for Use (Detection Switches)

■ Usage, storage, and transport conditions (except turquoise switches)

During usage, storage, or transportation, avoid locations subject to direct sunlight and maintain normal temperature, humidity, and pressure conditions.

The allowable specifications for environments suitable for usage, storage, and transportation are given below.

- 1) Temperature: The allowable temperature range differs for each switch, so refer to the switch's individual specifications. In addition, when transporting or storing switches while they are tube packaged, there are cases when the temperature may differ from the allowable range. In this situation, be sure to consult the individual specifications.
- 2) Humidity: The allowable humidity range differs for each switch, so refer to the switch's individual specifications.
- 3) Pressure: 86 to 106 kPa
The humidity range varies with the temperature. Use within the range indicated in the graph below.

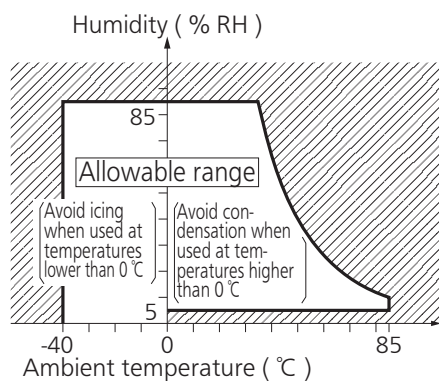

(The allowable temperature depends on the switch.)

- Condensation will occur inside the switch if there is a sudden change in ambient temperature when used in an atmosphere of high temperature and high humidity. This is particularly likely to happen when being transported by ship, so please be careful of the atmosphere when shipping. Condensation is the phenomenon whereby steam condenses to cause water droplets that adhere to the switch when an atmosphere of high temperature and humidity rapidly changes from a high to low temperature or when the switch is quickly moved from a low humidity location to one of high temperature and humidity. Please be careful because condensation can cause adverse conditions such as deterioration of insulation, coil cutoff, and rust.
- Condensation or other moisture may freeze on the switch when the temperature is lower than 0 °C 32 °F. This causes problems such as sticking of movable parts or operational time lags.
- The plastic becomes brittle if the switch is exposed to a low temperature, low humidity environment for long periods of time.
- Storage for extended periods of time (including transportation periods) at high temperatures or high humidity levels or in atmospheres with organic gases or sulfide gases may cause a sulfide film or oxide film to form on the surfaces of the contacts and/ or it may interfere with the functions. Check out the atmosphere in which the units are to be stored and transported.
- In terms of the packing format used, make every effort to keep the effects of moisture, organic gases and sulfide gases to the absolute minimum.

■ We reserve the right to modify without notice the materials, internal components, and other parts to improve product quality.





■ Handling precautions

When handling the switches, be careful not to drop them on the floor since this may damage them.

■ Others

- 1) Failure modes of switches include short-circuiting, open circuiting and temperature rises. If this switch is to be used in equipment where safety is a prime consideration, examine the possible effects of these failures on the equipment concerned, and ensure safety by providing protection circuits or protection devices. In terms of the systems involved, make provision for redundancy in the design and take steps to achieve safety design.
- 2) The ambient operating temperature (and humidity) range quoted is the range in which the switch can be operated on a continuous basis: it does not mean that using the switch within the rating guarantees the durability performance and environment withstanding performance of the switch. For details on the performance guarantee, check the specifications of each product concerned.

Technical Terminology & Cautions for Use (Detection Switches)

Shape	Classification	Pretravel (PT)	Overtravel (OT)	Operating Force (OF)	Vibration Shock	Features
	Pin plunger	Small	Small	Large	Outstanding	Appropriate for linear short-stroke action. Pin plunger acts directly on snap action mechanism, enabling high-precision positioning. Amount of movement after operation is smallest among all of the actuators, however, so reliable stopper is required.
	Hinge lever	Large	Medium	Small	Possible	Little force required for operation. Appropriate for use with low-speed cams and dogs; has large stroke. Lever available in various shapes to fit operating unit.
	Simulated roller lever	Large	Medium	Small	Possible	Tip of hinge lever is bent into a semi-circle, enabling use as a simple roller type.
	Leaf lever	Large	Large	Small	Excellent	Play in lever is used to assure maximum stroke. Construction provides for space where lever is attached, for outstanding resistance to freezing.
	Hinge roller lever	Large	Medium	Small	Possible	This is a hinge lever with a roller, and can be used with high-speed cams and dogs. The force required for pin plunger action is lighter than that of the lever, and the stroke is longer.

■ Global Sales Network Information: industry.panasonic.com/global/en/salesnetwork/globalnetwork

Panasonic
INDUSTRY

Panasonic Industry Co., Ltd.

Electromechanical Control Business Division

■ 1006, Oaza Kadoma, Kadoma-shi, Osaka 571-8506, Japan
industry.panasonic.com

NRFND.PGE0002.04.09.2026 AHF2 (TiP Switch) Notice

Affected Series	Affected Part Numbers
AHF2 (TiP) Switches	AHF21
AHF2 (TiP) Switches	AHF22
AHF2 (TiP) Switches	AHF23

Affected Parts List

Suggested Replacement Series	Suggested Replacement Part Numbers
N/A	N/A
N/A	N/A
N/A	N/A

