



800 E. Northwest Highway Des Plaines, IL 60016

Product/Process Change Notice (PCN)

PCN#: ESW490-68 **Date:** April 10th, 2026

Product Identification:

IXYS Brand Break-Over Diode (IXBOD)

Implementation Date for Change:

May 11th, 2026

Contact Information

Name: Salvador M. Cortez Jr.

Title: Product Marketing Engineer

Phone #: +63 920 966 2341

Fax#: N/A

E-mail: SCortez@littelfuse.com

Category of Change:

- Assembly Process
- Data Sheet
- Technology
- Discontinuance/Obsolescence
- Equipment
- Manufacturing Site
- Raw Material
- Testing
- Fabrication Process
- Other: _____

Description of Change:

Littelfuse wants to inform you that we have completed the qualification and transition from IXBOD1 to IXBOD2 products to support long term supply continuity.

- 1) Silicon Die: Yes.
- 2) Backend Assembly Bill of Materials: Yes, refer to PCN report
- 3) Backend Assembly Process Flow: Yes: Clip bond to wire bond
- 4) Backend Assembly Equipment: Equal or better
- 5) Marking & Labeling: Yes, refer to PCN report

Product form, fit, function changes: Yes, refer to PCN report

Part number changes: Refer to List of Affected Part Numbers

Important Dates:

- Qualification Samples Available: Last Time Buy:
- Final Qualification Data Available:
- Date of Final Product Shipment:

Method of Distinguishing Changed Product

- Product Mark,
- Date Code, Traceability data available upon request
- Other,

Demonstrated or Anticipated Impact on Form, Fit, Function or Reliability:

None

LF Qualification Plan/Results:

All affected parts have been fully qualified in accordance with established performance and reliability criteria.

Customer Acknowledgement of Receipt: Littelfuse requests you acknowledge receipt of this PCN. In your acknowledgement, you can grant approval or request additional information. Littelfuse will assume the change is acceptable if no acknowledgement is received within 30 days of this notice. Lack of any additional response within 90 days of PCN issuance further constitutes acceptance of the change.

PCN Report

Prepared By : Salvador M. Cortez Jr., Product Marketing Engineer
Date : April 10th, 2026
Products : Break-Over Diode (IXBOD) Discrete and Module Parts
Revision : A

1.0 Objective:

This Product Change Notice (PCN) report documents the qualification and release of the IXBOD2 product family as the replacement for IXBOD1 devices.

2.0 Applicable Products:

This PCN applies to IXYS brand Break-Over Diode discrete and module parts. A complete list of affected and replacement part numbers is provided in Appendix A.

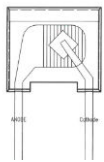
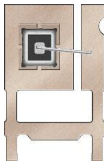

3.0 Physical Differences/ Changes:

3.1 Internal Assembly Change – Discrete and Module



ITEMS	BEFORE	AFTER	REMARKS
Internal Assembly			From clip bonding to wire bonding
Chip/Die	BWP, Solderable	BWEP, Bondable	
Bonding	Clip bonding	Wire bonding	

3.2 Marking

Discrete

ITEMS	BEFORE	AFTER	REMARKS
Marking Visual (Discrete)			
Line 1	IXYS	IXYS + Symbol	Symbol was added
Line 2	Part number	Part number	No change
Line 3	Datecode	Datecode	No change
Line 4	Cathode (K), Anode (A)	Cathode (K), Anode (A)	No change

Module





ITEMS	BEFORE	AFTER	REMARKS
Marking Visual (Module)			
Line 1	IXYS + Symbol	IXYS + Symbol	No change
Line 2	Part number + Datecode	Part number + Datecode	No change
Line 3	Cathode (K), Anode (A)	Cathode (K), Anode (A)	No change

3.3 Packing Method and Label

Discrete

ITEMS	BEFORE	AFTER	REMARKS
Pouch /box label	 Label size : 80x30mm	 Label size : 96x40mm	Standard Littelfuse label format
RoHS sticker	 Sticker size : 80x50mm	 Sticker size : 96x40mm	Standard Littelfuse label format
Anti-static pouch	 Pouch size :100x150x0.1mm	 Pouch size :100x155x0.1mm	Equivalent or better

Module

ITEMS	BEFORE	AFTER	REMARKS
Label	 Label size : 100x130mm	 Label size : 96x40mm	From: With QR code To: Remove QR code
Packing box	 Foam board :Black	 Foam board :White	From: Black foam board To: White foam board

3.4 Package Outline Dimension (POD)

Discrete

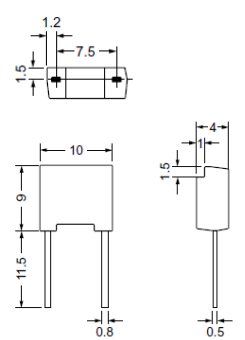
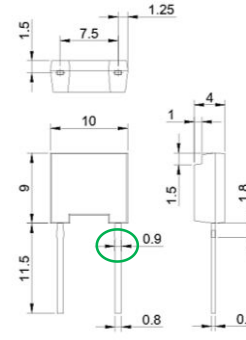
ITEMS	BEFORE	AFTER	REMARKS
Package Outline Dimension (POD)			<p>○ - Tie bar cutting clearance</p> <p>Dimensions in mm (1 mm = 0.0394")</p>

Module

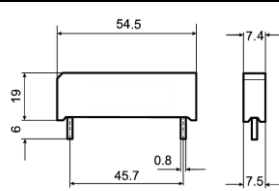
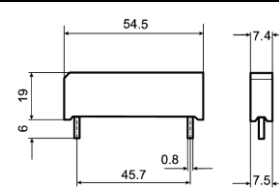
ITEMS	BEFORE	AFTER	REMARKS
Package Outline Dimension (POD)			<p>No change</p> <p>Dimensions in mm (1 mm = 0.0394")</p>

4.0 Reliability Test Result

Discrete

PACKAGE	PART NUMBER	REL-TEST	CONDITIONS	SAMPLE SIZE	STATUS	RESULT
FP Case IXBOD2-XX	IXBOD2-12	HTRB	1008hrs, 125°C, 800V Half Sine AC	20	FINISHED	Completed: Passed Reliability
	IXBOD2-12	T/C	100 cycles, -40°C/150°C, glued on heatsink	20	FINISHED	Completed: Passed Reliability
	IXBOD2-12	uHAST	96 hrs, 130°C, 85% R.H.,	20	FINISHED	Completed: Passed Reliability
	IXBOD2-10	HTRB	1008hrs, 125°C, 800V Half Sine AC	20	FINISHED	Completed: Passed Reliability
	IXBOD2-10	T/C	100 cycles, -40°C/150°C, glued on heatsink	20	FINISHED	Completed: Passed Reliability
	IXBOD2-10	uHAST	96 hrs, 130°C, 85% R.H.,	20	FINISHED	Completed: Passed Reliability
	IXBOD2-07	HTRB	1008hrs, 125°C, 800V Half Sine AC	20	FINISHED	Completed: Passed Reliability



Module

PACKAGE	PART NUMBER	REL-TEST	CONDITIONS	SAMPLE SIZE	STATUS	RESULT
FP Case IXBOD2-R/ RD	IXBOD2-28R	T/C	100 cycles, -40°C/150°C, glued on heatsink	5	FINISHED	Completed: Passed Reliability
		uHAST	96 hrs, 130°C, 85% R.H.,	10	FINISHED	Completed: Passed Reliability

5.0 Recommendations & Conclusions:

Based on the completed qualification activities and the corresponding evaluation results, Littelfuse concludes that the IXBOD2 product family—including both discrete and module devices—has successfully met all defined release criteria.

Accordingly, the affected products are approved and ready to proceed to mass production.

Appendix A: Detail Part Number List Affected

IXBOD	SAP PART NUMBER
Discrete	IXBOD2-07
Discrete	IXBOD2-08
Discrete	IXBOD2-09
Discrete	IXBOD2-10
Discrete	IXBOD2-10SA
Discrete	IXBOD2-10SB
Discrete	IXBOD2-11
Discrete	IXBOD2-12
Module	IXBOD2-11RD
Module	IXBOD2-12R
Module	IXBOD2-12RD
Module	IXBOD2-14R
Module	IXBOD2-14RD
Module	IXBOD2-15R
Module	IXBOD2-15RD
Module	IXBOD2-16R
Module	IXBOD2-16RD
Module	IXBOD2-17R
Module	IXBOD2-17RD
Module	IXBOD2-18R
Module	IXBOD2-18RD
Module	IXBOD2-19R
Module	IXBOD2-19RD
Module	IXBOD2-20R
Module	IXBOD2-20RD
Module	IXBOD2-21R
Module	IXBOD2-21RD
Module	IXBOD2-22R
Module	IXBOD2-22RD
Module	IXBOD2-23R
Module	IXBOD2-23RD
Module	IXBOD2-24R

IXBOD	SAP PART NUMBER
Module	IXBOD2-24RD
Module	IXBOD2-24RD-S1
Module	IXBOD2-25R
Module	IXBOD2-25RD
Module	IXBOD2-25RDL
Module	IXBOD2-26R
Module	IXBOD2-26RD
Module	IXBOD2-28R
Module	IXBOD2-28RD
Module	IXBOD2-30R
Module	IXBOD2-30RD
Module	IXBOD2-32R
Module	IXBOD2-32RD
Module	IXBOD2-32RZ
Module	IXBOD2-33R
Module	IXBOD2-34R
Module	IXBOD2-36R
Module	IXBOD2-38R
Module	IXBOD2-40R
Module	IXBOD2-42R
Module	IXBOD2-36RD
SET	IXBOD2-SET-SA01/08
SET	IXBOD2-SET-SA01/13
SET	IXBOD2-SET-SA01/14
SET	IXBOD2-SET-SA01/24
SET	IXBOD2-SET-SA01/25
SET	IXBOD2-SET-SA02/00
SET	IXBOD2-SET-SA04/98
SET	IXBOD2-SET-SA04/99
SET	IXBOD2-SET-SA05/00
SET	IXBOD2-SET-SA09/98
SET	IXBOD2-SET-SA10/98



8755 W. Higgins Road
Suite 500
Chicago, Illinois USA 60631

April 10th, 2026

ESW490-68 – IXYS Brand Break-Over Diode (IXBOD) Product Transition and Qualification

To our valued customers,

Littelfuse would like to inform you that we have completed the qualification and transition from the IXYS Brand Break-Over Diode IXBOD1 product family to the IXBOD2 series. This Product Change Notice follows the previously issued ESW490-66 (EOL and Pre-PCN) and supports long-term supply continuity.

The transition includes updates to the manufacturing site, assembly process and related materials. All affected products have been qualified in accordance with Littelfuse's established performance and reliability requirements.

Detailed qualification results are provided in the attached PCN report.

Form, fit, function changes	: Yes, refer to PCN report for full details
Part number changes	: Yes, IXBOD1 to IXBOD2 transition
Effective date	: May 11 th , 2026
Replacement products	: Refer to attached list of affected part numbers

This notification is for your information and acknowledgement. If you require specific data or product samples to certify this change, please contact Littelfuse within 90 days of the notification date.

If you have any other questions or concerns, please contact your local sales team or Salvador Cortez, Product Marketing Engineer, for support with Power Discrete Bipolar.

We value your business and look forward to assisting you whenever possible.

Thank you very much!

Best Regards,

Salvador M. Cortez Jr.
Global Product Marketing Engineer
Power Bipolar Discrete (Thyristor+Diode)
Littelfuse Asia Sales B.V. PH Branch
Mobile: +63 920 966 2341
SCortez@littelfuse.com

IXBOD	SAP PART NUMBER
Discrete	IXBOD2-07
Discrete	IXBOD2-08
Discrete	IXBOD2-09
Discrete	IXBOD2-10
Discrete	IXBOD2-10SA
Discrete	IXBOD2-10SB
Discrete	IXBOD2-11
Discrete	IXBOD2-12
Module	IXBOD2-11RD
Module	IXBOD2-12R
Module	IXBOD2-12RD
Module	IXBOD2-14R
Module	IXBOD2-14RD
Module	IXBOD2-15R
Module	IXBOD2-15RD
Module	IXBOD2-16R
Module	IXBOD2-16RD
Module	IXBOD2-17R
Module	IXBOD2-17RD
Module	IXBOD2-18R
Module	IXBOD2-18RD
Module	IXBOD2-19R
Module	IXBOD2-19RD
Module	IXBOD2-20R
Module	IXBOD2-20RD
Module	IXBOD2-21R
Module	IXBOD2-21RD
Module	IXBOD2-22R
Module	IXBOD2-22RD
Module	IXBOD2-23R
Module	IXBOD2-23RD
Module	IXBOD2-24R
Module	IXBOD2-24RD
Module	IXBOD2-24RD-S1
Module	IXBOD2-25R
Module	IXBOD2-25RD
Module	IXBOD2-25RDL
Module	IXBOD2-26R
Module	IXBOD2-26RD
Module	IXBOD2-28R
Module	IXBOD2-28RD
Module	IXBOD2-30R
Module	IXBOD2-30RD
Module	IXBOD2-32R
Module	IXBOD2-32RD

Module	IXBOD2-32RZ
Module	IXBOD2-33R
Module	IXBOD2-34R
Module	IXBOD2-36R
Module	IXBOD2-38R
Module	IXBOD2-40R
Module	IXBOD2-42R
Module	IXBOD2-36RD
SET	IXBOD2-SET-SA01/08
SET	IXBOD2-SET-SA01/13
SET	IXBOD2-SET-SA01/14
SET	IXBOD2-SET-SA01/24
SET	IXBOD2-SET-SA01/25
SET	IXBOD2-SET-SA02/00
SET	IXBOD2-SET-SA04/98
SET	IXBOD2-SET-SA04/99
SET	IXBOD2-SET-SA05/00
SET	IXBOD2-SET-SA09/98
SET	IXBOD2-SET-SA10/98