

MSTB 2,5/ 3-ST - PCB connector



1754465

<https://www.phoenixcontact.com/us/products/1754465>

Please be informed that the data shown in this PDF document is generated from our Online Catalog. Please find the complete data in the user documentation. Our General Terms of Use for Downloads are valid.

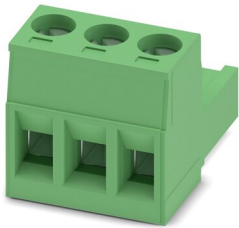

PCB connector, nominal cross section: 2.5 mm², color: green, nominal current: 12 A, rated voltage (III/2): 320 V, contact surface: Tin, type of contact: Socket, number of potentials: 3, number of rows: 1, number of positions: 3, number of connections: 3, product range: MSTB 2,5/..-ST, pitch: 5 mm, connection method: Screw connection with tension sleeve, screw head form: L Slotted, conductor/PCB connection direction: 0 °, locking clip: - Locking clip, plug-in system: COMBICON MSTB 2,5, locking: without, mounting: without, type of packaging: packed in cardboard

Your advantages

- Well-known connection principle allows worldwide use
- Low temperature rise, thanks to maximum contact force
- Allows connection of two conductors

Commercial Data

| | |
|--------------------------------------|---------------------|
| Item number | 1754465 |
| Packing unit | 1 pc |
| Minimum order quantity | 1 pc |
| Sales Key | AA03 |
| Product Key | AACAFC |
| Catalog Page | Page 262 (C-1-2013) |
| GTIN | 4017918028633 |
| Weight per Piece (including packing) | 5.107 g |
| Weight per Piece (excluding packing) | 5.107 g |
| Customs tariff number | 85366990 |
| Country of origin | DE |

MSTB 2,5/ 3-ST - PCB connector



1754465

<https://www.phoenixcontact.com/us/products/1754465>

Technical Data

Product properties

| | |
|-----------------------|-----------------------|
| Type | Standard |
| Product line | COMBICON Connectors M |
| Product type | PCB plug |
| Product family | MSTB 2,5/..-ST |
| Number of positions | 3 |
| Pitch | 5 mm |
| Number of connections | 3 |
| Number of rows | 1 |
| Mounting flange | without |
| Number of potentials | 3 |

Electrical properties

| | |
|-----------------------------|--------|
| Nominal current I_N | 12 A |
| Nominal voltage U_N | 320 V |
| Degree of pollution | 3 |
| Contact resistance | 1.4 mΩ |
| Rated voltage (III/3) | 250 V |
| Rated surge voltage (III/3) | 4 kV |
| Rated voltage (III/2) | 320 V |
| Rated surge voltage (III/2) | 4 kV |
| Rated voltage (II/2) | 630 V |
| Rated surge voltage (II/2) | 4 kV |

Connection data

Connection technology

| | |
|-----------------------|---------------------|
| Type | Standard |
| Connector system | COMBICON MSTB 2,5 |
| Nominal cross section | 2.5 mm ² |
| Type of contact | Socket |

Interlock

| | |
|-----------------|---------|
| Locking type | without |
| Mounting flange | without |

Conductor connection

| | |
|--|--|
| Connection method | Screw connection with tension sleeve |
| Conductor/PCB connection direction | 0 ° |
| Conductor cross section rigid | 0.2 mm ² ... 2.5 mm ² |
| Conductor cross section flexible | 0.2 mm ² ... 2.5 mm ² |
| Conductor cross section AWG | 24 ... 12 |
| Conductor cross section flexible, with ferrule without plastic | 0.25 mm ² ... 2.5 mm ² |

MSTB 2,5/ 3-ST - PCB connector

1754465

<https://www.phoenixcontact.com/us/products/1754465>

| | |
|---|--|
| sleeve | |
| Conductor cross section, flexible, with ferrule, with plastic sleeve | 0.25 mm ² ... 2.5 mm ² |
| 2 conductors with same cross section, solid | 0.2 mm ² ... 1 mm ² |
| 2 conductors with same cross section, flexible | 0.2 mm ² ... 1.5 mm ² |
| 2 conductors with same cross section, flexible, with ferrule without plastic sleeve | 0.25 mm ² ... 1 mm ² |
| 2 conductors with the same cross section, flexible, with TWIN ferrule with plastic sleeve | 0.5 mm ² ... 1.5 mm ² |
| Cylindrical gauge a x b / diameter | 2.8 mm x 2.0 mm / 2.4 mm |
| Stripping length | 7 mm |
| Tightening torque | 0.5 Nm ... 0.6 Nm |

Material specifications

Material data - contact

| | |
|--|--|
| Note | WEEE/RoHS-compliant, free of whiskers according to IEC 60068-2-82/JEDEC JESD 201 |
| Contact material | Cu alloy |
| Surface characteristics | hot-dip tin-plated |
| Metal surface terminal point (top layer) | Tin (5 - 7 µm Sn) |
| Metal surface contact area (top layer) | Tin (5 - 7 µm Sn) |

Material data - housing

| | |
|---|--------------|
| Color (Housing) | green (6021) |
| Insulating material | PA |
| Insulating material group | I |
| CTI according to IEC 60112 | 600 |
| Flammability rating according to UL 94 | V0 |
| Glow wire flammability index GWFI according to EN 60695-2-12 | 850 |
| Glow wire ignition temperature GWIT according to EN 60695-2-13 | 775 |
| Temperature for the ball pressure test according to EN 60695-10-2 | 125 °C |

Dimensions

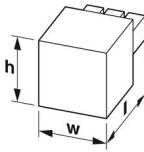
| | |
|---------------------|--|
| Dimensional drawing |  |
| Pitch | 5 mm |
| Width [w] | 15 mm |
| Height [h] | 15 mm |
| Length [l] | 18.2 mm |

Mounting

MSTB 2,5/ 3-ST - PCB connector



1754465

<https://www.phoenixcontact.com/us/products/1754465>

| | |
|-----------------------|--------------------------------------|
| Drive form screw head | Slotted (L) |
| Connection method | Screw connection with tension sleeve |
| Drive form screw head | Slotted (L) |

Notes

| | |
|--------------------|--|
| Notes on operation | In accordance with IEC 61984, COMBICON connectors have no switching power (COC). During designated use, they must not be plugged in or disconnected when carrying voltage or under load. |
|--------------------|--|

Mechanical tests

Test for conductor damage and slackening

| | |
|---------------|---------------------|
| Specification | IEC 60999-1:1999-11 |
| Result | Test passed |

Pull-out test

| | |
|---|---|
| Specification | IEC 60999-1:1999-11 |
| Conductor cross section/conductor type/tractive force setpoint/actual value | 0.2 mm ² / solid / > 10 N |
| | 0.2 mm ² / flexible / > 10 N |
| | 2.5 mm ² / solid / > 50 N |
| | 2.5 mm ² / flexible / > 50 N |

Insertion and withdrawal forces

| | |
|-------------------------------------|-------------|
| Result | Test passed |
| No. of cycles | 25 |
| Insertion strength per pos. approx. | 8 N |
| Withdraw strength per pos. approx. | 6 N |

Torque test

| | |
|---------------|---------------------|
| Specification | IEC 60999-1:1999-11 |
|---------------|---------------------|

Contact holder in insert

| | |
|---|------------------------|
| Specification | IEC 60512-15-1:2008-05 |
| Contact holder in insert Requirements >20 N | Test passed |

Resistance of inscriptions

| | |
|---------------|------------------------|
| Specification | IEC 60068-2-70:1995-12 |
| Result | Test passed |

Polarization and coding

| | |
|---------------|------------------------|
| Specification | IEC 60512-13-5:2006-02 |
| Result | Test passed |

Visual inspection

| | |
|---------------|-----------------------|
| Specification | IEC 60512-1-1:2002-02 |
| Result | Test passed |

Dimension check

MSTB 2,5/ 3-ST - PCB connector



1754465

<https://www.phoenixcontact.com/us/products/1754465>

| | |
|---------------|-----------------------|
| Specification | IEC 60512-1-2:2002-02 |
| Result | Test passed |

Environmental and real-life conditions

Vibration test

| | |
|------------------------|-----------------------------|
| Specification | IEC 60068-2-6:2007-12 |
| Frequency | 10 - 150 - 10 Hz |
| Sweep speed | 1 octave/min |
| Amplitude | 0.35 mm (10 Hz ... 60.1 Hz) |
| Sweep speed | 5g (60.1 Hz ... 150 Hz) |
| Test duration per axis | 2.5 h |

Durability test

| | |
|--|-----------------------|
| Specification | IEC 60512-9-1:2010-03 |
| Impulse withstand voltage at sea level | 4.8 kV |
| Contact resistance R ₁ | 1.4 mΩ |
| Contact resistance R ₂ | 1.5 mΩ |
| Insertion/withdrawal cycles | 25 |
| Insulation resistance, neighboring positions | > 5 MΩ |

Climatic test

| | |
|-----------------------------------|---|
| Specification | ISO 6988:1985-02 |
| Corrosive stress | 0.2 dm ³ SO ₂ on 300 dm ³ /40 °C/1 cycle |
| Thermal stress | 100 °C/168 h |
| Power-frequency withstand voltage | 2.21 kV |

Ambient conditions

| | |
|---|---|
| Ambient temperature (operation) | -40 °C ... 100 °C (dependent on the derating curve) |
| Ambient temperature (storage/transport) | -40 °C ... 70 °C |
| Relative humidity (storage/transport) | 30 % ... 70 % |
| Ambient temperature (assembly) | -5 °C ... 100 °C |

Electrical tests

Thermal test | Test group C

| | |
|----------------------------|-----------------------|
| Specification | IEC 60512-5-1:2002-02 |
| Tested number of positions | 24 |

Insulation resistance

| | |
|--|-----------------------|
| Specification | IEC 60512-3-1:2002-02 |
| Insulation resistance, neighboring positions | > 5 MΩ |

Air clearances and creepage distances |

| | |
|--|---------------------|
| Specification | IEC 60664-1:2007-04 |
| Insulating material group | I |
| Comparative tracking index (IEC 60112) | CTI 600 |

MSTB 2,5/ 3-ST - PCB connector



1754465

<https://www.phoenixcontact.com/us/products/1754465>

| | |
|--|--------|
| Rated insulation voltage (III/3) | 250 V |
| Rated surge voltage (III/3) | 4 kV |
| minimum clearance value - non-homogenous field (III/3) | 3 mm |
| minimum creepage distance (III/3) | 3.2 mm |
| Rated insulation voltage (III/2) | 320 V |
| Rated surge voltage (III/2) | 4 kV |
| minimum clearance value - non-homogenous field (III/2) | 3 mm |
| minimum creepage distance (III/2) | 3 mm |
| Rated insulation voltage (II/2) | 630 V |
| Rated surge voltage (II/2) | 4 kV |
| minimum clearance value - non-homogenous field (II/2) | 3 mm |
| minimum creepage distance (II/2) | 3.2 mm |

MSTB 2,5/ 3-ST - PCB connector



1754465

<https://www.phoenixcontact.com/us/products/1754465>

Drawings

Diagram

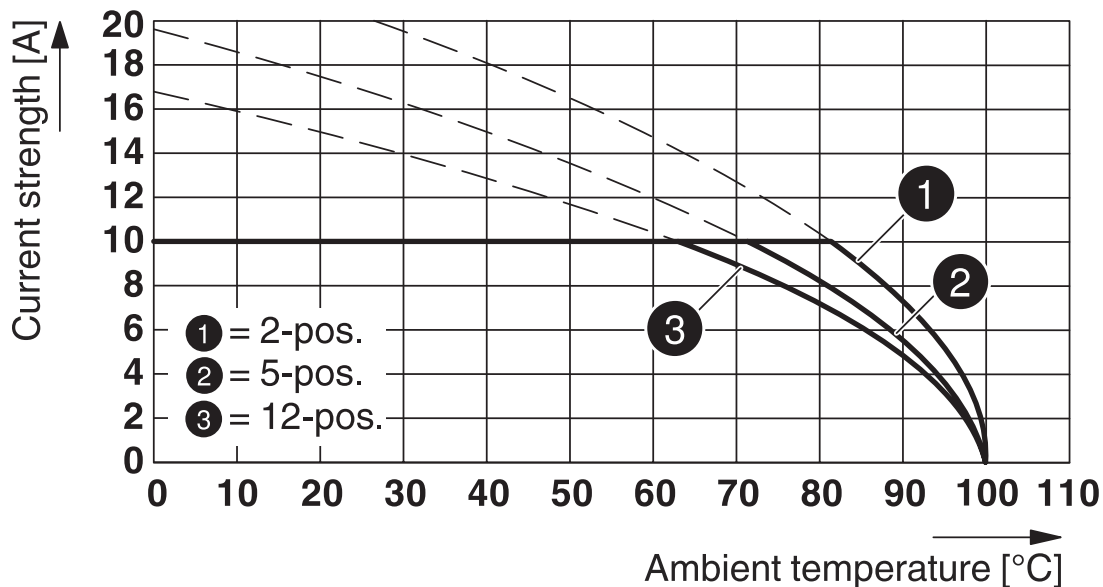

Type: MSTB 2,5/...-ST with MDSTBW 2,5/...-G

Diagram

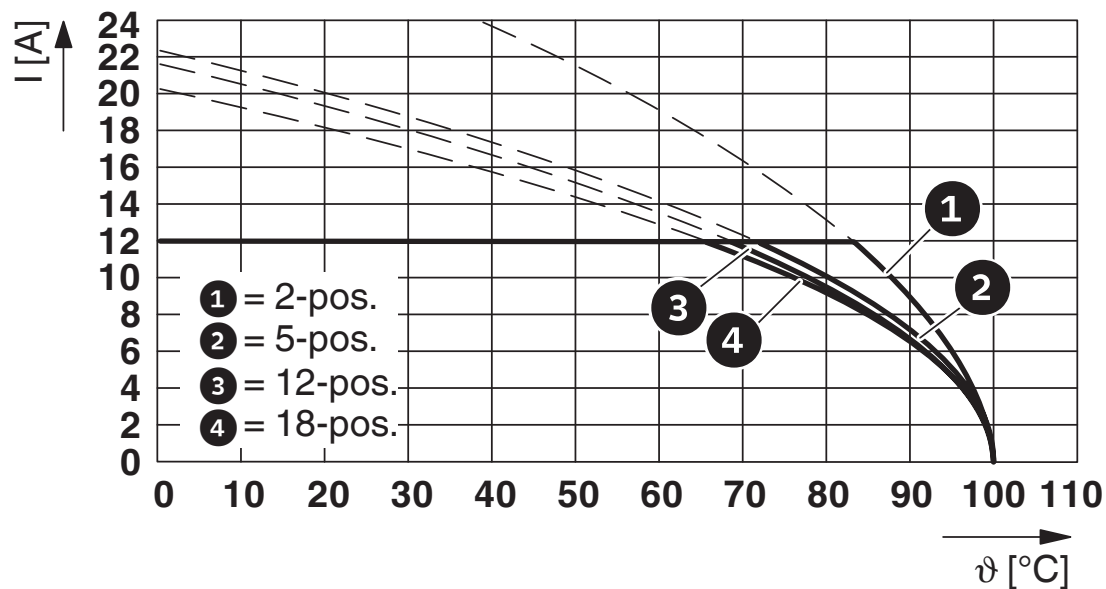

Type: MSTB 2,5/...-ST with FKIC 2,5/...-ST

MSTB 2,5/ 3-ST - PCB connector



1754465

<https://www.phoenixcontact.com/us/products/1754465>

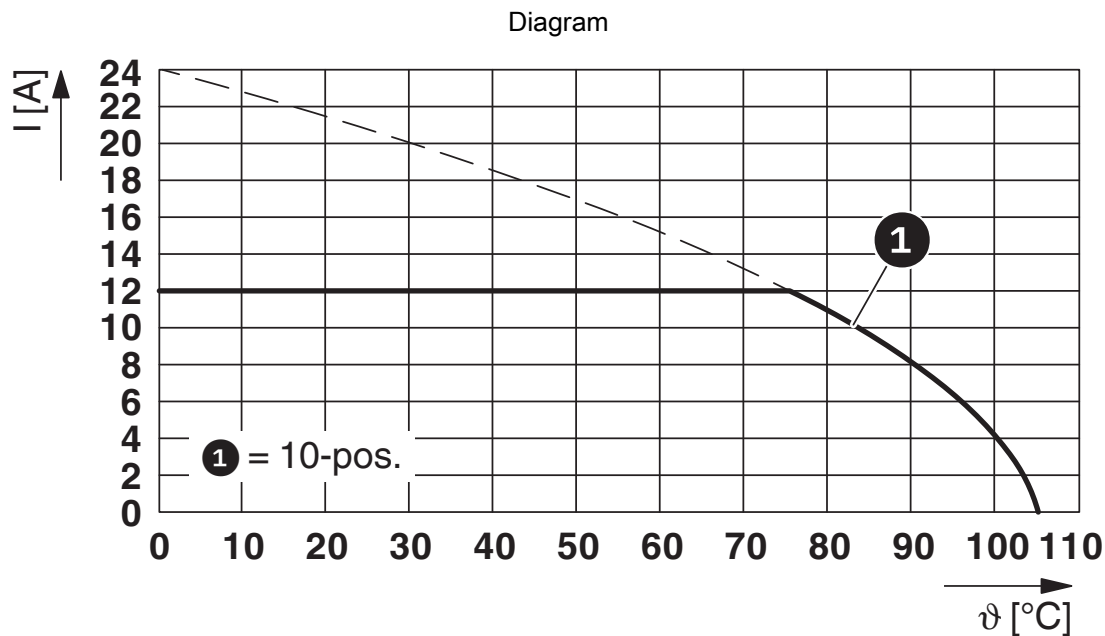

Type: MSTB 2,5/...-ST with UMSTBHK 2,5/...-G

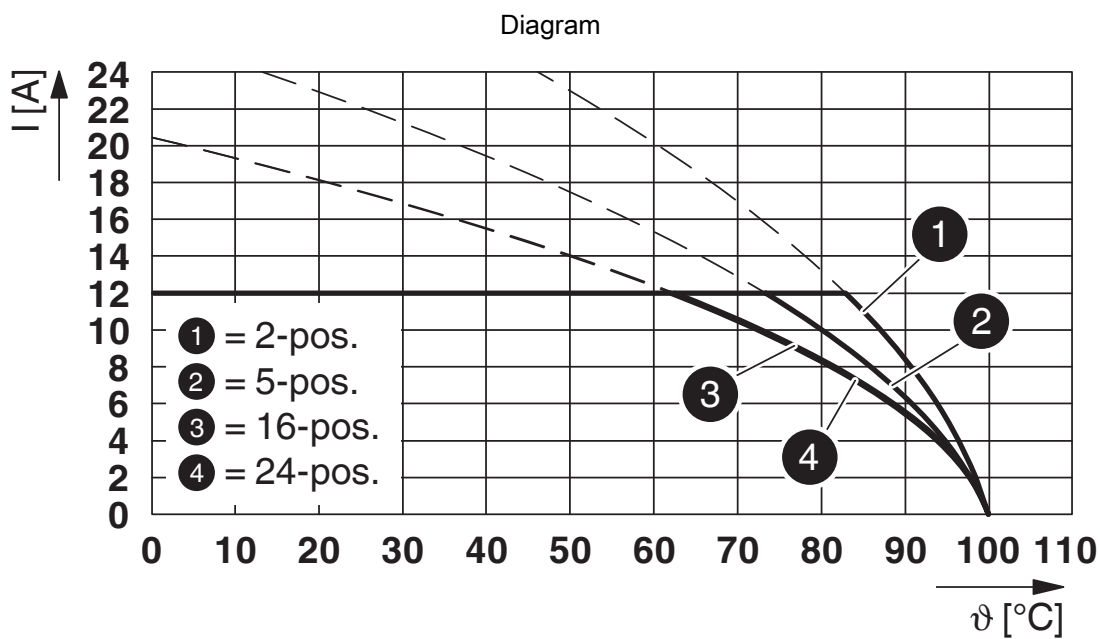

Type: MSTB 2,5/...-ST with MSTB 2,5/...-G

MSTB 2,5/ 3-ST - PCB connector



1754465

<https://www.phoenixcontact.com/us/products/1754465>

Diagram

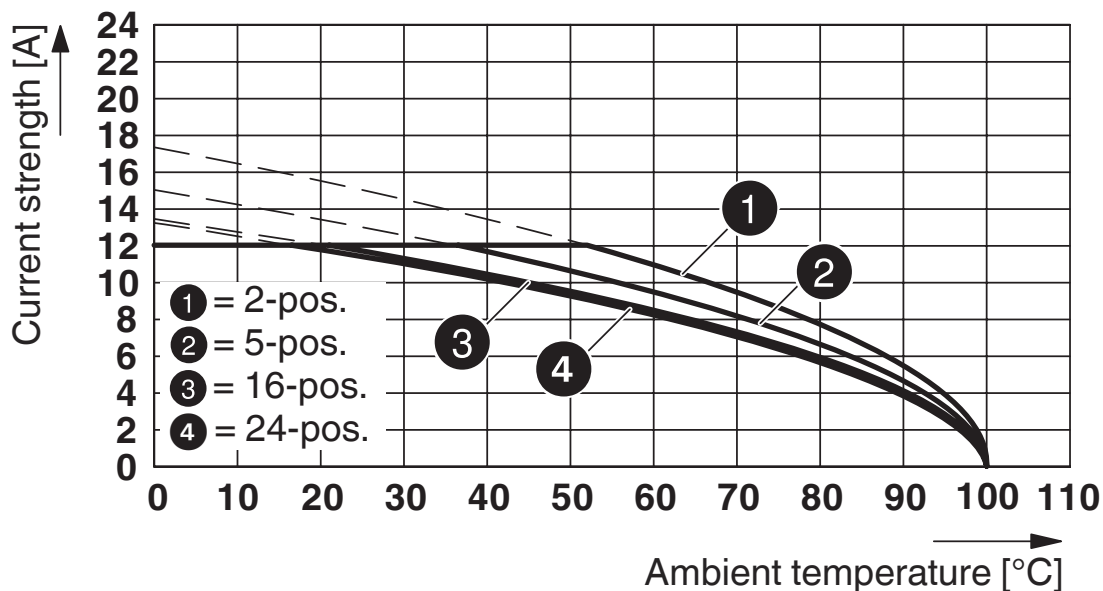

Type: MSTB 2,5/...-ST with MSTBVA 2,5/...-G

Diagram

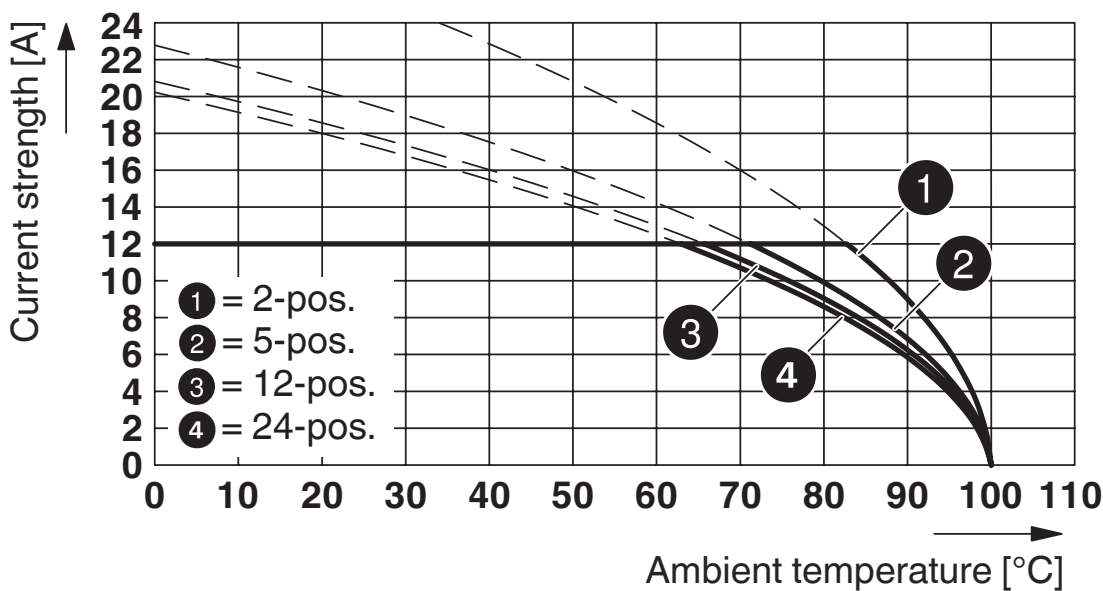

Type: MSTB 2,5/...-ST with CCVA 2,5/...-G P20 THR

MSTB 2,5/ 3-ST - PCB connector



1754465

<https://www.phoenixcontact.com/us/products/1754465>

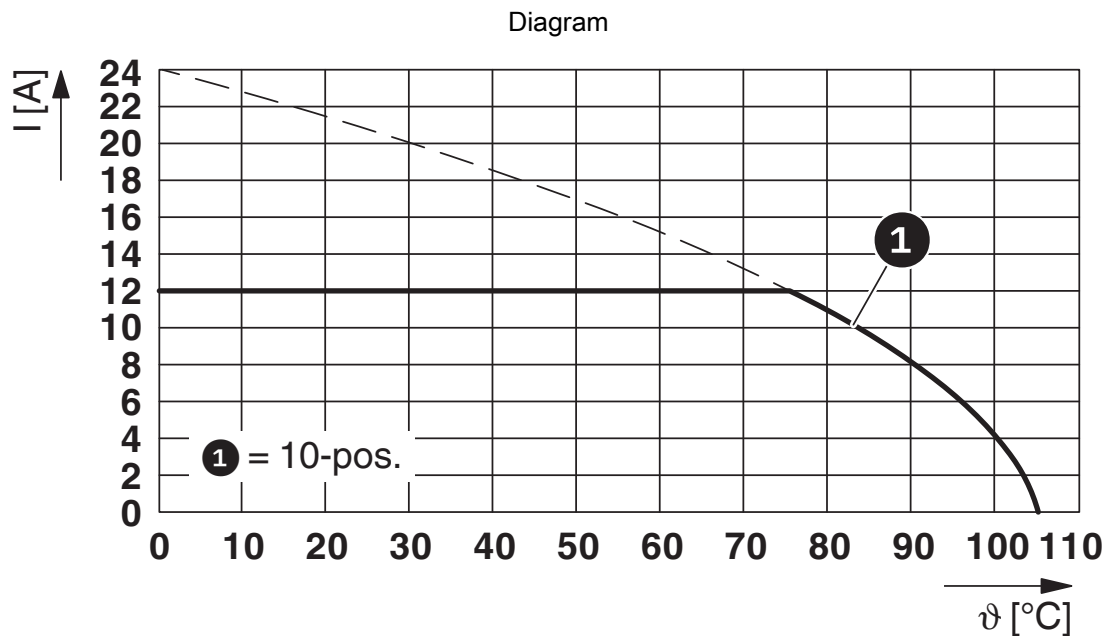

Type: MSTB 2,5/...-ST with MSTBHK 2,5/...-G

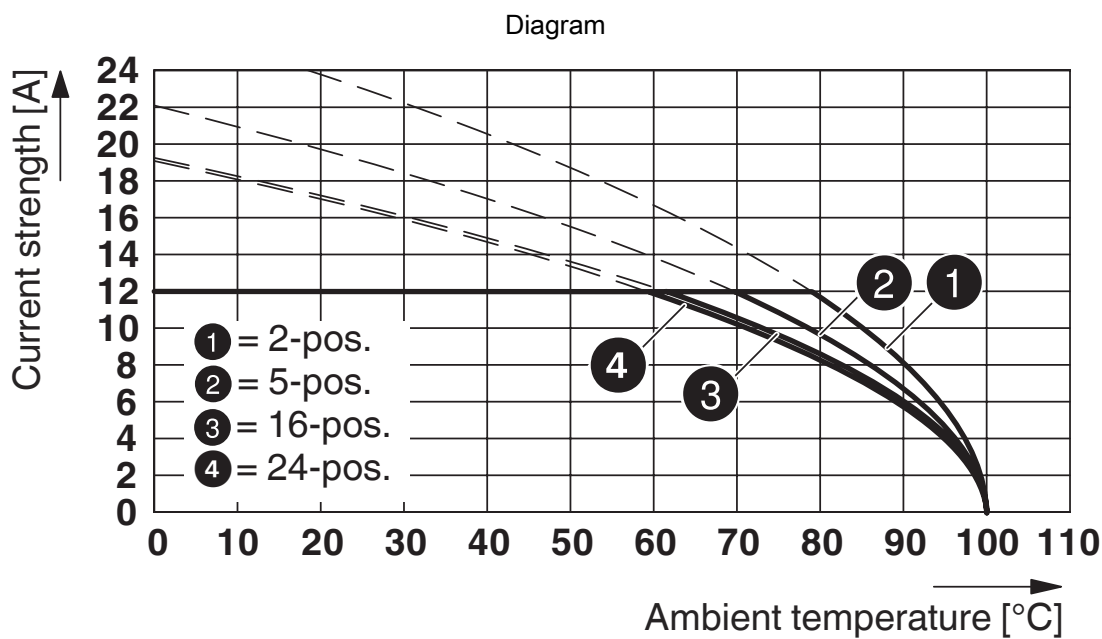

Type: MSTB 2,5/...-ST with SMSTBA 2,5/...-G

MSTB 2,5/ 3-ST - PCB connector



1754465

<https://www.phoenixcontact.com/us/products/1754465>

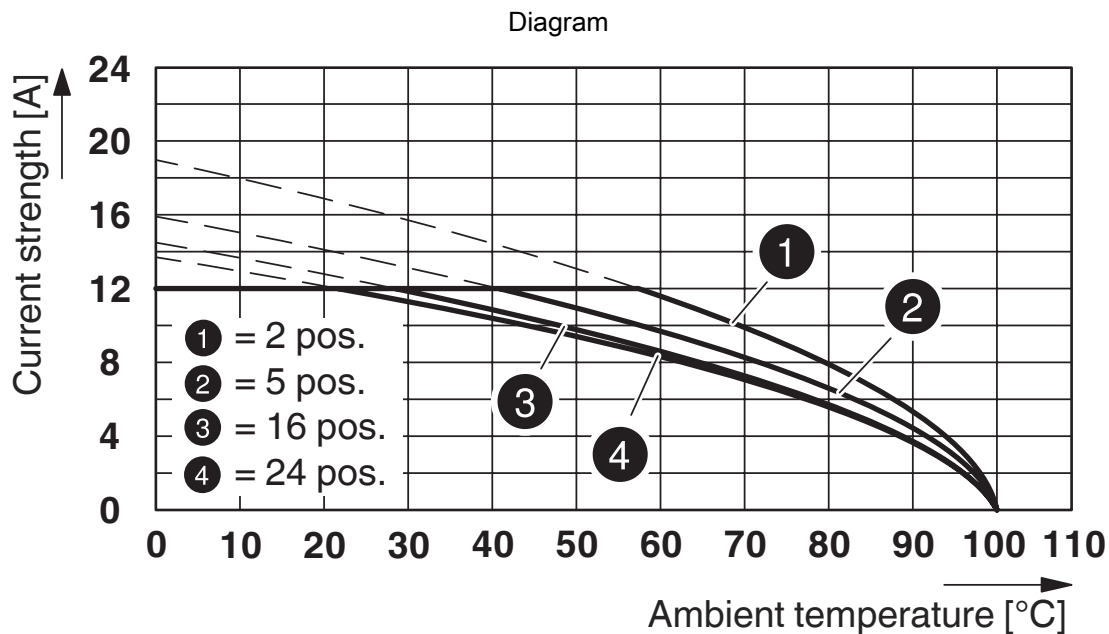

Type: MSTB 2,5/...-ST with MSTBV 2,5/...-G

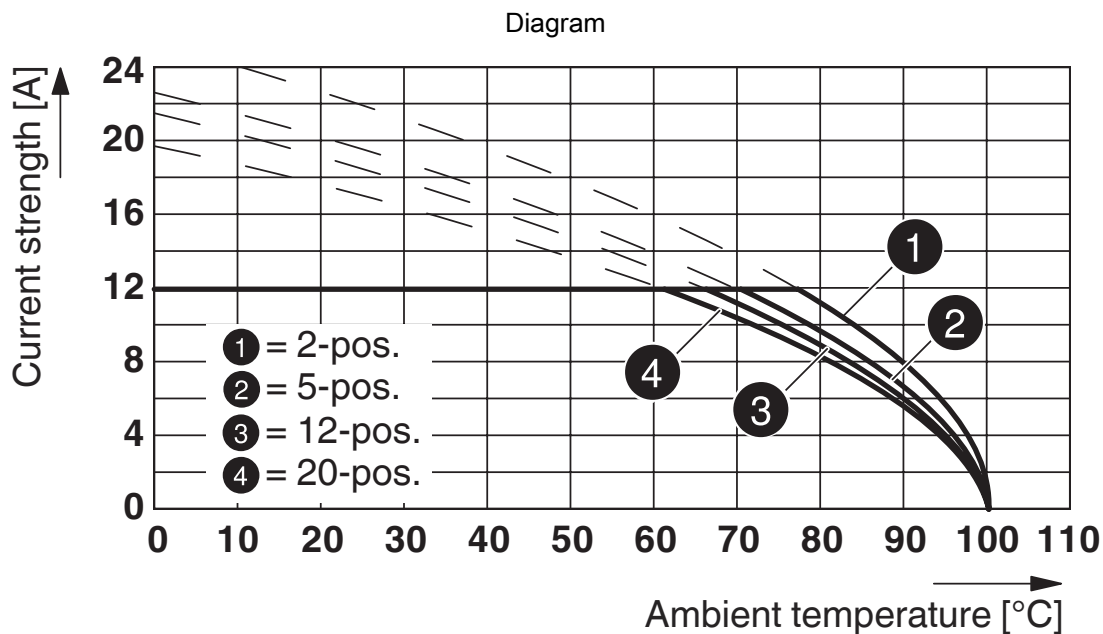

Type: MSTB 2,5/...-ST with MSTBW 2,5/...-G

MSTB 2,5/ 3-ST - PCB connector



1754465

<https://www.phoenixcontact.com/us/products/1754465>

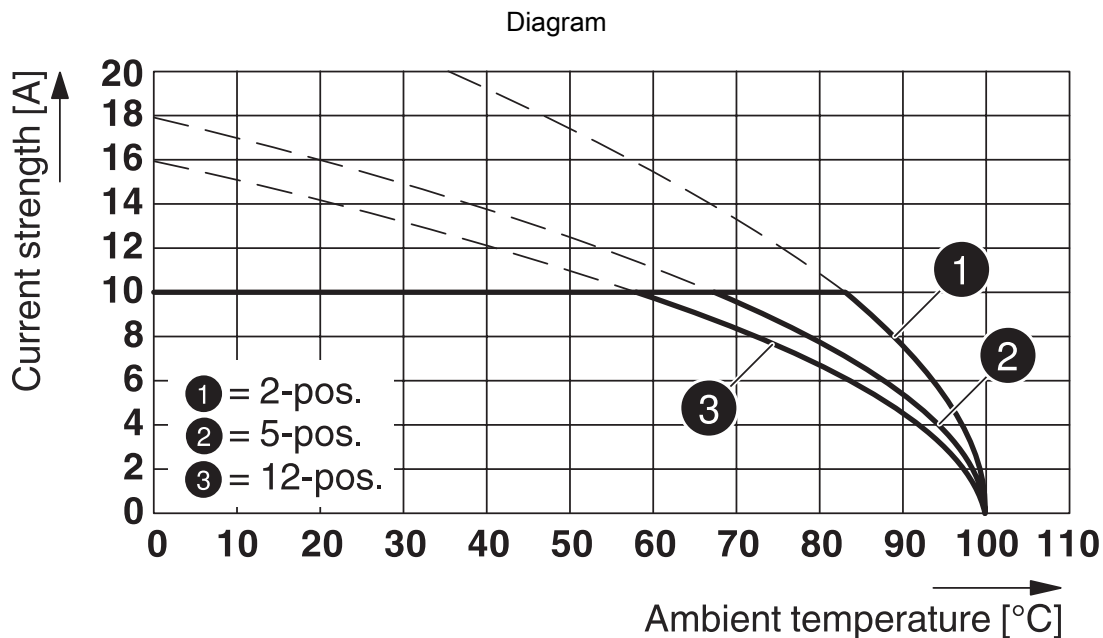

Type: MSTB 2,5/...-ST with MDSTB 2,5/...-G

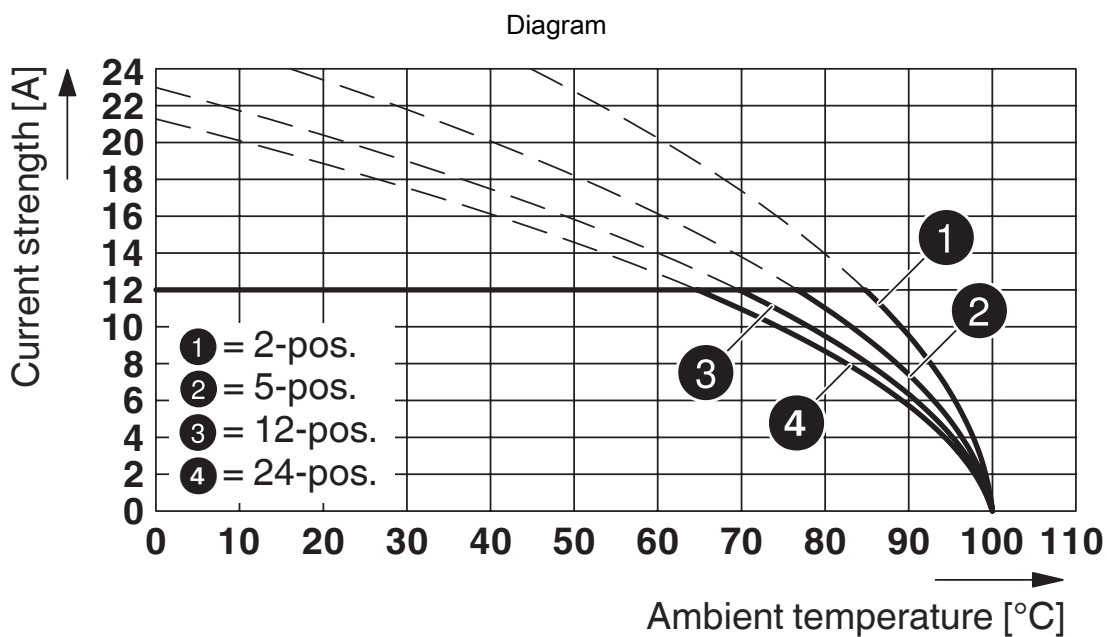

Type: MSTB 2,5/...-ST with CCA 2,5/...-G P20 THR

MSTB 2,5/ 3-ST - PCB connector



1754465

<https://www.phoenixcontact.com/us/products/1754465>

Diagram

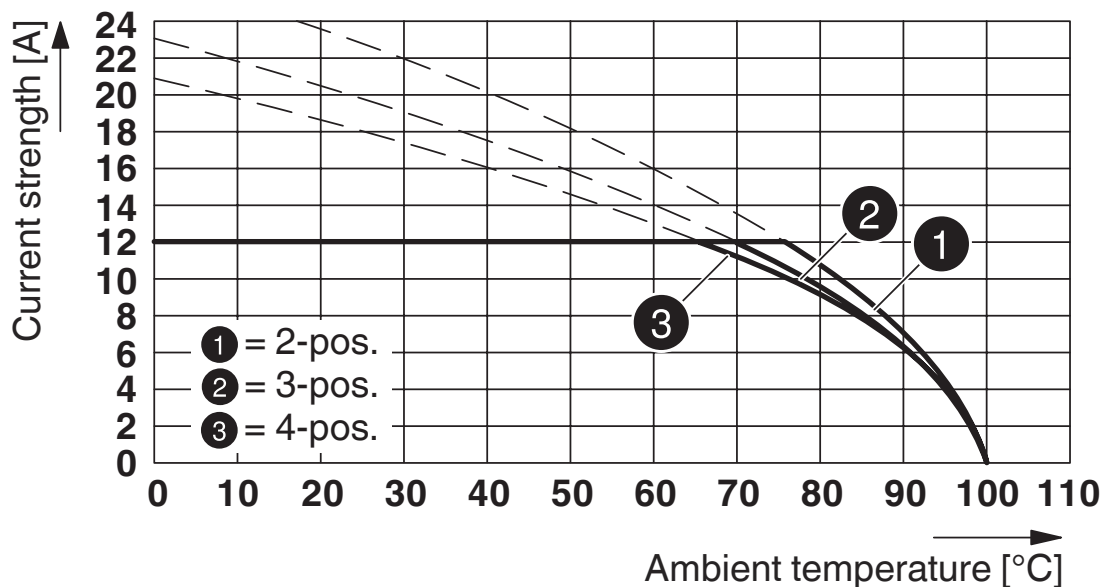

Type: MSTB 2,5/...-ST with MSTBO 2,5/...-G1L

Diagram

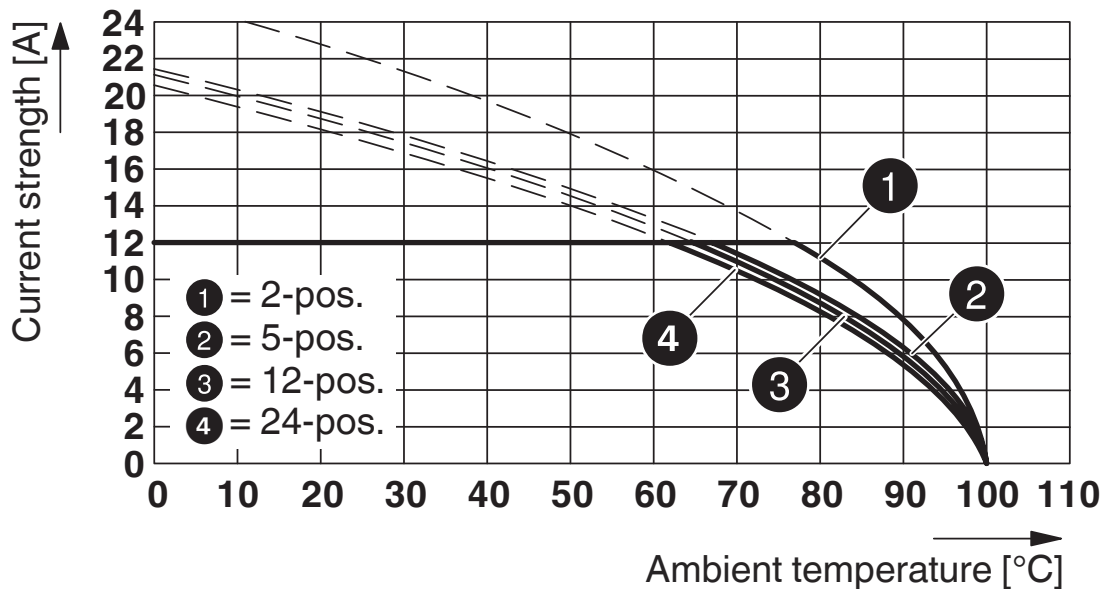

Type: MSTB 2,5/...-ST with MSTBA 2,5/...-G

MSTB 2,5/ 3-ST - PCB connector



1754465

<https://www.phoenixcontact.com/us/products/1754465>

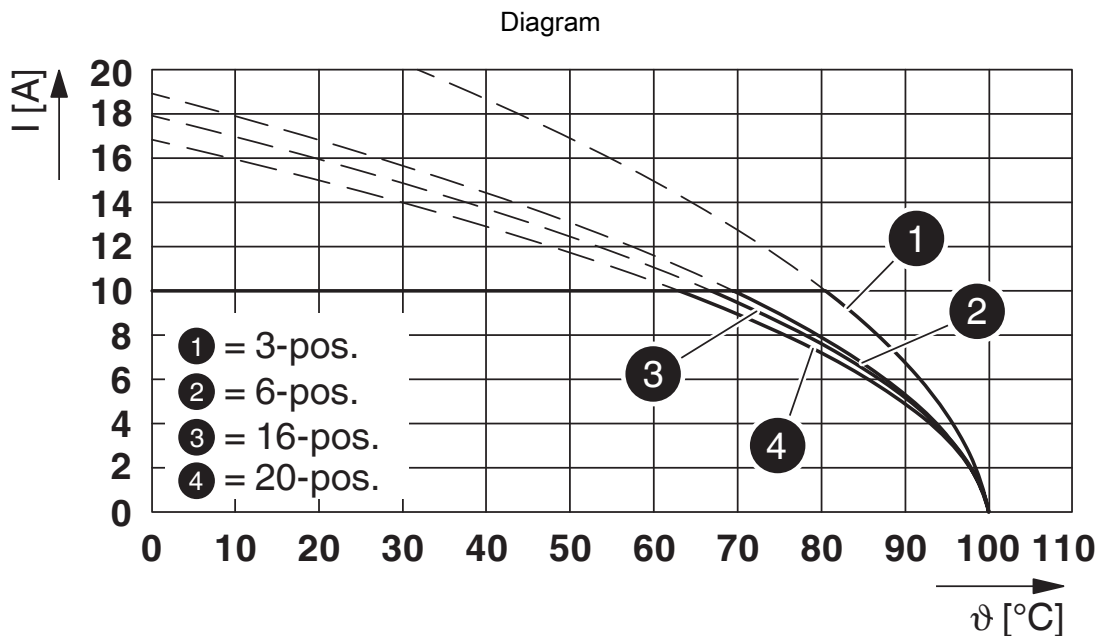

Type: MSTB 2,5/...-ST with MDSTB 2,5/...-G1

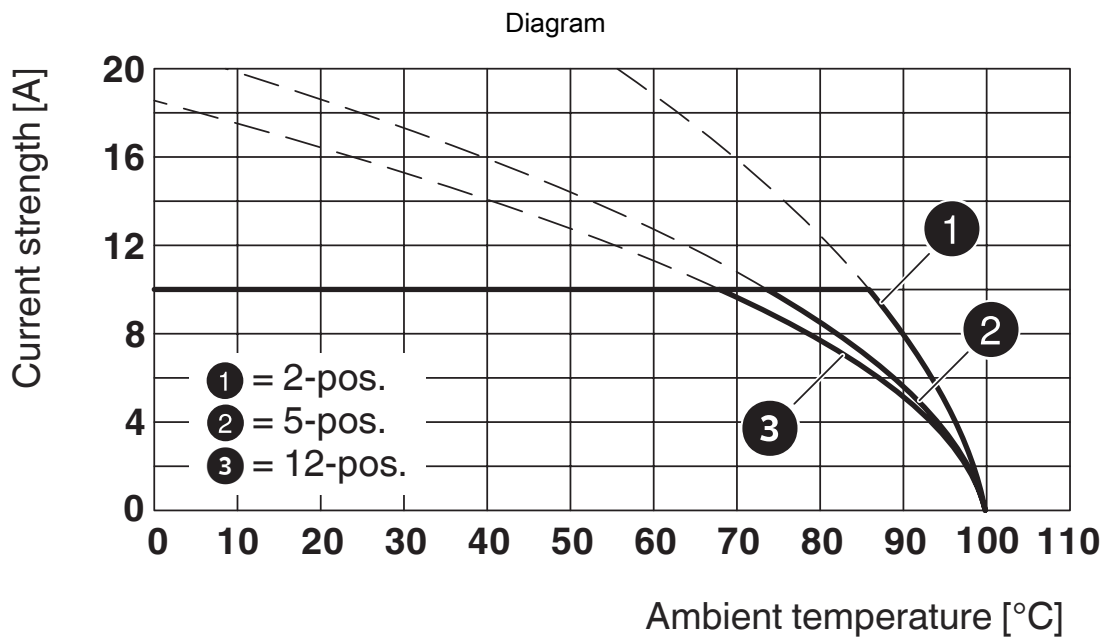

Type: MSTB 2,5/...-ST with MDSTBV 2,5/...-G

MSTB 2,5/ 3-ST - PCB connector



1754465

<https://www.phoenixcontact.com/us/products/1754465>

Diagram

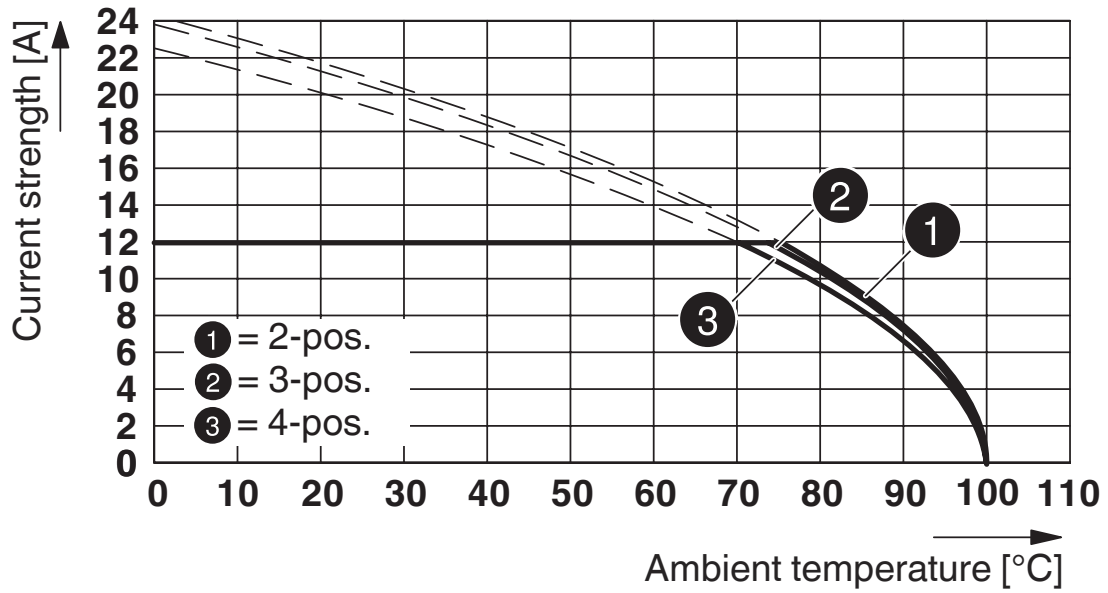

Type: MSTB 2,5/...-ST with MSTBO 2,5/...-G1R

MSTB 2,5/ 3-ST - PCB connector



1754465

<https://www.phoenixcontact.com/us/products/1754465>

Approvals

To download certificates, visit the product detail page: <https://www.phoenixcontact.com/us/products/1754465>

|  CSA Approval ID: 13631 | | | | |
|--|-----------------------|-----------------------|-------------------|-----------------------------|
| | Nominal Voltage U_N | Nominal Current I_N | Cross Section AWG | Cross Section mm^2 |
| Use group B | 300 V | 15 A | 28 - 12 | - |
| Use group D | 300 V | 10 A | 28 - 12 | - |

|  IECEE CB Scheme Approval ID: DE1-60988-B1B2 | | | | |
|---|-----------------------|-----------------------|-------------------|-----------------------------|
| | Nominal Voltage U_N | Nominal Current I_N | Cross Section AWG | Cross Section mm^2 |
| | 250 V | 12 A | - | 0.2 - 2.5 |

|  EAC Approval ID: B.01687 | | | | |
|--|--|--|--|--|
|--|--|--|--|--|

|  cULus Recognized Approval ID: E60425-19931011 | | | | |
|---|-----------------------|-----------------------|-------------------|-----------------------------|
| | Nominal Voltage U_N | Nominal Current I_N | Cross Section AWG | Cross Section mm^2 |
| Use group B | 300 V | 15 A | 30 - 12 | - |
| Use group D | 300 V | 10 A | 30 - 12 | - |

|  VDE Zeichengenehmigung Approval ID: 40004701 | | | | |
|--|-----------------------|-----------------------|-------------------|-----------------------------|
| | Nominal Voltage U_N | Nominal Current I_N | Cross Section AWG | Cross Section mm^2 |
| | 250 V | 12 A | - | 0.2 - 2.5 |

MSTB 2,5/ 3-ST - PCB connector



1754465

<https://www.phoenixcontact.com/us/products/1754465>

Classifications

ECLASS

| | |
|-------------|----------|
| ECLASS-11.0 | 27460202 |
| ECLASS-12.0 | 27460202 |
| ECLASS-13.0 | 27460202 |

ETIM

| | |
|----------|----------|
| ETIM 8.0 | EC002638 |
|----------|----------|

UNSPSC

| | |
|-------------|----------|
| UNSPSC 21.0 | 39121400 |
|-------------|----------|

MSTB 2,5/ 3-ST - PCB connector



1754465

<https://www.phoenixcontact.com/us/products/1754465>

Environmental Product Compliance

| | |
|------------|---|
| China RoHS | Environmentally friendly use period: unlimited = EFUP-e |
| | No hazardous substances above threshold values |

MSTB 2,5/ 3-ST - PCB connector

1754465

<https://www.phoenixcontact.com/us/products/1754465>

Accessories

 Note: Applying some accessories below might limit this product.

EBP 2- 5 - Insertion bridge

1733169

<https://www.phoenixcontact.com/us/products/1733169>

Insertion bridge for connectors with 5.0 mm or 5.08 mm pitch



 Max. current carrying capacity: 12 A

EBP 3- 5 - Insertion bridge

1733172

<https://www.phoenixcontact.com/us/products/1733172>

Insertion bridge for connectors with 5.0 mm or 5.08 mm pitch



 Max. current carrying capacity: 12 A

MSTB 2,5/ 3-ST - PCB connector

1754465

<https://www.phoenixcontact.com/us/products/1754465>



SZS 0,6X3,5 - Screwdriver

1205053

<https://www.phoenixcontact.com/us/products/1205053>



Actuation tool, for ST terminal blocks, insulated, also suitable for use as a bladed screwdriver, size: 0.6 x 3.5 x 100 mm, 2-component grip, with non-slip grip

KGG-MSTB 2,5/ 3 - Cable housing

1803947

<https://www.phoenixcontact.com/us/products/1803947>



Cable housing, pitch: 0 mm, number of positions: 3, color: green

MSTB 2,5/ 3-ST - PCB connector

1754465

<https://www.phoenixcontact.com/us/products/1754465>



CP-MSTB - Coding profile

1734634

<https://www.phoenixcontact.com/us/products/1734634>

Coding profile, is inserted into the slot on the plug or inverted header, red insulating material



SK 5/3,8:FORTL.ZAHLEN - Marker card

0804183

<https://www.phoenixcontact.com/us/products/0804183>

Marker card, white, labeled, horizontal: consecutive numbers 1 ... 10, 11 ... 20, etc. up to 91 ... (99)100, mounting type: adhesive, for terminal block width: 5 mm, lettering field size: 5 x 3.8 mm



MSTB 2,5/ 3-ST - PCB connector

1754465

<https://www.phoenixcontact.com/us/products/1754465>



SK 5/3,8:UNBEDRUCKT - Marker card

0805409

<https://www.phoenixcontact.com/us/products/0805409>

Marker card, Din A4, white, unlabeled, can be labeled with: Marker pen: without print, mounting type: adhesive, for terminal block width: 5 mm, lettering field size: 5 x 3.8 mm, Number of individual labels: 1



EBP 2- 5 - Insertion bridge

1733169

<https://www.phoenixcontact.com/us/products/1733169>

Insertion bridge for connectors with 5.0 mm or 5.08 mm pitch



MSTB 2,5/ 3-ST - PCB connector

1754465

<https://www.phoenixcontact.com/us/products/1754465>

MSTBW 2,5/ 3-G - PCB header

1736108

<https://www.phoenixcontact.com/us/products/1736108>

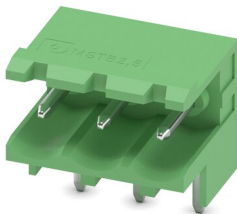

PCB headers, nominal cross section: 2.5 mm², color: green, nominal current: 12 A, rated voltage (III/2): 320 V, contact surface: Tin, type of contact: Pin, number of potentials: 3, number of rows: 1, number of positions: 3, number of connections: 3, product range: MSTBW 2,5/..-G, pitch: 5 mm, mounting: Wave soldering, pin layout: Linear pinning, solder pin [P]: 3.5 mm, number of solder pins per potential: 1, plug-in system: COMBICON MSTB 2,5, Pin connector pattern alignment: Standard, locking: without, mounting: without, type of packaging: packed in cardboard

MDSTB 2,5/ 3-G1 - PCB header

1736687

<https://www.phoenixcontact.com/us/products/1736687>



PCB headers, nominal cross section: 2.5 mm², color: green, nominal current: 10 A, rated voltage (III/2): 320 V, contact surface: Tin, type of contact: Pin, number of potentials: 6, number of rows: 2, number of positions: 3, number of connections: 6, product range: MDSTB 2,5/..-G1, pitch: 5 mm, mounting: Wave soldering, pin layout: Linear pinning, solder pin [P]: 3.5 mm, number of solder pins per potential: 1, plug-in system: COMBICON MSTB 2,5, Pin connector pattern alignment: Standard, locking: without, mounting: without, type of packaging: packed in cardboard, In combination with MVSTB or FKCV plug components, both an MVSTBW (or FKCVW) and an MVSTBR plug (or FKCVR) must be used. Combination with TMSTBP plug components is not possible!

MSTB 2,5/ 3-ST - PCB connector

1754465

<https://www.phoenixcontact.com/us/products/1754465>

SMSTB 2,5/ 3-G - PCB header

1769243

<https://www.phoenixcontact.com/us/products/1769243>



PCB headers, nominal cross section: 2.5 mm², color: green, nominal current: 12 A, rated voltage (III/2): 320 V, contact surface: Tin, type of contact: Pin, number of potentials: 3, number of rows: 1, number of positions: 3, number of connections: 3, product range: SMSTB 2,5/..-G, pitch: 5 mm, mounting: Wave soldering, pin layout: Linear pinning, solder pin [P]: 3.5 mm, number of solder pins per potential: 1, plug-in system: COMBICON MSTB 2,5, Pin connector pattern alignment: Standard, locking: without, mounting: without, type of packaging: packed in cardboard

SMSTBA 2,5/ 3-G - PCB header

1769816

<https://www.phoenixcontact.com/us/products/1769816>



PCB headers, nominal cross section: 2.5 mm², color: green, nominal current: 12 A, rated voltage (III/2): 320 V, contact surface: Tin, type of contact: Pin, number of potentials: 3, number of rows: 1, number of positions: 3, number of connections: 3, product range: SMSTBA 2,5/..-G, pitch: 5 mm, mounting: Wave soldering, pin layout: Linear pinning, solder pin [P]: 3.5 mm, number of solder pins per potential: 1, plug-in system: COMBICON MSTB 2,5, Pin connector pattern alignment: Standard, locking: without, mounting: without, type of packaging: packed in cardboard

MSTB 2,5/ 3-ST - PCB connector

1754465

<https://www.phoenixcontact.com/us/products/1754465>

MDSTBVA 2,5/ 3-G - PCB header

1845798

<https://www.phoenixcontact.com/us/products/1845798>

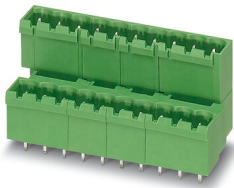

PCB headers, nominal cross section: 2.5 mm², color: green, nominal current: 10 A, rated voltage (III/2): 320 V, contact surface: Tin, type of contact: Pin, number of potentials: 6, number of rows: 2, number of positions: 3, number of connections: 6, product range: MDSTBVA 2,5/..-G, pitch: 5 mm, mounting: Wave soldering, pin layout: Linear pinning, solder pin [P]: 3.9 mm, number of solder pins per potential: 1, plug-in system: COMBICON MSTB 2,5, Pin connector pattern alignment: Standard, locking: without, mounting: without, type of packaging: packed in cardboard, The article can be aligned to create different nos. of positions! In combination with MVSTB or FKCV plug components, both an MVSTBW (or FKCVW) and an MVSTBR plug (or FKCVR) must be used. Combination with TMSTBP plug components is not possible!

MDSTBA 2,5/ 3-G - PCB header

1846522

<https://www.phoenixcontact.com/us/products/1846522>

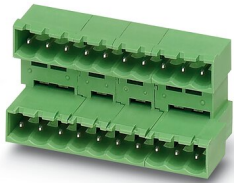

PCB headers, nominal cross section: 2.5 mm², color: green, nominal current: 10 A, rated voltage (III/2): 320 V, contact surface: Tin, type of contact: Pin, number of potentials: 6, number of rows: 2, number of positions: 3, number of connections: 6, product range: MDSTBA 2,5/..-G, pitch: 5 mm, mounting: Wave soldering, pin layout: Linear pinning, solder pin [P]: 3.2 mm, number of solder pins per potential: 1, plug-in system: COMBICON MSTB 2,5, Pin connector pattern alignment: Standard, locking: without, mounting: without, type of packaging: packed in cardboard, The article can be aligned to create different nos. of positions! In combination with MVSTB or FKCV plug components, both an MVSTBW (or FKCVW) and an MVSTBR plug (or FKCVR) must be used. Combination with TMSTBP plug components is not possible!

MSTB 2,5/ 3-ST - PCB connector

1754465

<https://www.phoenixcontact.com/us/products/1754465>



MSTBO 2,5/ 3-G1L - PCB header

1861028

<https://www.phoenixcontact.com/us/products/1861028>



PCB headers, nominal cross section: 2.5 mm², color: green, nominal current: 12 A, rated voltage (III/2): 320 V, contact surface: Tin, type of contact: Pin, number of rows: 1, number of positions: 3, product range: MSTBO 2,5/..-G1L, pitch: 5 mm, mounting: Wave soldering, pin layout: Linear pinning, solder pin [P]: 3.5 mm, number of solder pins per potential: 1, plug-in system: COMBICON MSTB 2,5, locking: without, type of packaging: packed in cardboard, Product with pin output on left side

MSTBO 2,5/ 3-G1R - PCB header

1861031

<https://www.phoenixcontact.com/us/products/1861031>



PCB headers, nominal cross section: 2.5 mm², color: green, nominal current: 12 A, rated voltage (III/2): 320 V, contact surface: Tin, type of contact: Pin, number of potentials: 3, number of rows: 1, number of positions: 3, number of connections: 3, product range: MSTBO 2,5/..-G1R, pitch: 5 mm, mounting: Wave soldering, pin layout: Linear pinning, solder pin [P]: 3.5 mm, number of solder pins per potential: 1, plug-in system: COMBICON MSTB 2,5, locking: without, type of packaging: packed in cardboard, Product with pin output on right side

MSTB 2,5/ 3-ST - PCB connector

1754465

<https://www.phoenixcontact.com/us/products/1754465>



MDSTBA 2,5/ 3-GL - PCB header

1874691

<https://www.phoenixcontact.com/us/products/1874691>

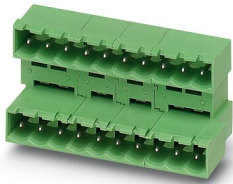

PCB headers, nominal cross section: 2.5 mm², color: green, nominal current: 10 A, rated voltage (III/2): 320 V, contact surface: Tin, type of contact: Pin, number of potentials: 6, number of rows: 2, number of positions: 3, number of connections: 6, product range: MDSTBA 2,5/..-G, pitch: 5 mm, mounting: Wave soldering, pin layout: Linear pinning, solder pin [P]: 3.2 mm, number of solder pins per potential: 1, plug-in system: COMBICON MSTB 2,5, Pin connector pattern alignment: Standard, locking: without, mounting: without, type of packaging: packed in cardboard, The article can be aligned to create different nos. of positions! In combination with MVSTB or FKCV plug components, both an MVSTBW (or FKCVW) and an MVSTBR plug (or FKCVR) must be used. Combination with TMSTBP plug components is not possible!

MDSTBA 2,5/ 3-GR - PCB header

1874701

<https://www.phoenixcontact.com/us/products/1874701>

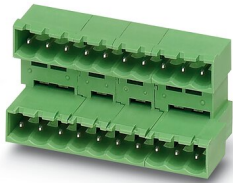

PCB headers, nominal cross section: 2.5 mm², color: green, nominal current: 10 A, rated voltage (III/2): 320 V, contact surface: Tin, type of contact: Pin, number of potentials: 6, number of rows: 2, number of positions: 3, number of connections: 6, product range: MDSTBA 2,5/..-G, pitch: 5 mm, mounting: Wave soldering, pin layout: Linear pinning, solder pin [P]: 3.2 mm, number of solder pins per potential: 1, plug-in system: COMBICON MSTB 2,5, Pin connector pattern alignment: Standard, locking: without, mounting: without, type of packaging: packed in cardboard, The article can be aligned to create different nos. of positions! In combination with MVSTB or FKCV plug components, both an MVSTBW (or FKCVW) and an MVSTBR plug (or FKCVR) must be used. Combination with TMSTBP plug components is not possible!

MSTB 2,5/ 3-ST - PCB connector

1754465

<https://www.phoenixcontact.com/us/products/1754465>



MSTBO 2,5/ 3 G1L THRR44 BK - PCB header

2915216

<https://www.phoenixcontact.com/us/products/2915216>



PCB headers, nominal cross section: 2.5 mm², color: black, nominal current: 16 A, rated voltage (III/2): 320 V, contact surface: Tin, type of contact: Pin, number of rows: 1, number of positions: 3, product range: MSTBO 2,5/..-G1L-THR, pitch: 5 mm, mounting: THR soldering, pin layout: Linear pinning, solder pin [P]: 2.5 mm, number of solder pins per potential: 1, plug-in system: COMBICON MSTB 2,5, locking: without, type of packaging: 44 mm wide tape, Article with lateral pin exit

MSTBO 2,5/ 3 G1R THRR44 BK - PCB header

2915229

<https://www.phoenixcontact.com/us/products/2915229>



PCB headers, nominal cross section: 2.5 mm², color: black, nominal current: 16 A, rated voltage (III/2): 320 V, contact surface: Tin, type of contact: Pin, number of rows: 1, number of positions: 3, product range: MSTBO 2,5/..-G1R-THR, pitch: 5 mm, mounting: THR soldering, pin layout: Linear pinning, solder pin [P]: 2.5 mm, number of solder pins per potential: 1, plug-in system: COMBICON MSTB 2,5, locking: without, type of packaging: 44 mm wide tape, Article with lateral pin exit

Phoenix Contact 2023 © - all rights reserved
<https://www.phoenixcontact.com>

Phoenix Contact USA
586 Fulling Mill Road
Middletown, PA 17057, United States
(+717) 944-1300
info@phoenixcon.com