

Board-to-board connectors

Product Overview 2023

Connectivity for all dimensions

With FP, FQ, FR, and FS series board-to-board connectors, Phoenix Contact provides shielded and unshielded solutions for signal and data transmission in the device.

This allows you to realize individual PCB orientations with various application-oriented designs, stack heights, and numbers of positions with pitches of 0.635 mm, 0.8 mm, 1.27 mm, and 2.54 mm.

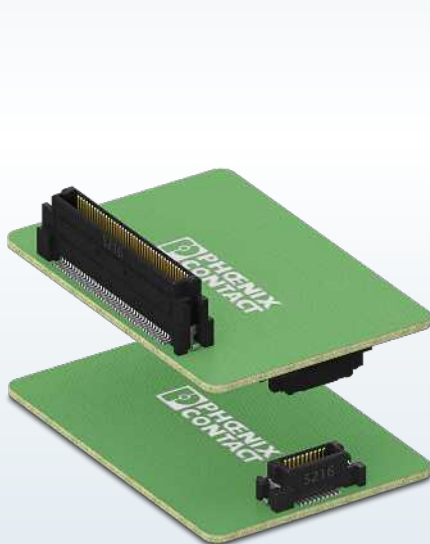
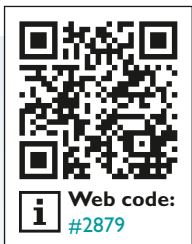

FS 0,635 unshielded

- Mezzanine high-speed board-to-board connections
- 0.635 mm pitch
- High contact density from 20- to 80-pos.
- Stack heights from 6 to 16.6 mm
- Data transmission up to 30 Gbps



FP 0,8 shielded

- Robust high-speed board-to-board connections
- 0.8 mm pitch
- High contact density from 12- to 80-pos.
- Stack heights from 6 to 21 mm
- Data transmission up to 52 Gbps
- Shielding for excellent EMC properties



FP 0,8 unshielded

- Robust high-speed board-to-board connections
- 0.8 mm pitch
- High contact density from 12- to 80-pos.
- Stack heights from 6 to 21 mm
- Data transmission up to 52 Gbps
- Suitable for automatic optical inspection (AOI) after reflow soldering

Find out more with the web code

For more information, use the web codes provided in this brochure. Simply enter # and the four-digit number in the search field on our website.

 **Web code: #1234** (example)

Or use the direct link:
phoenixcontact.net/webcode/#1234



 **Web code:**
#1520

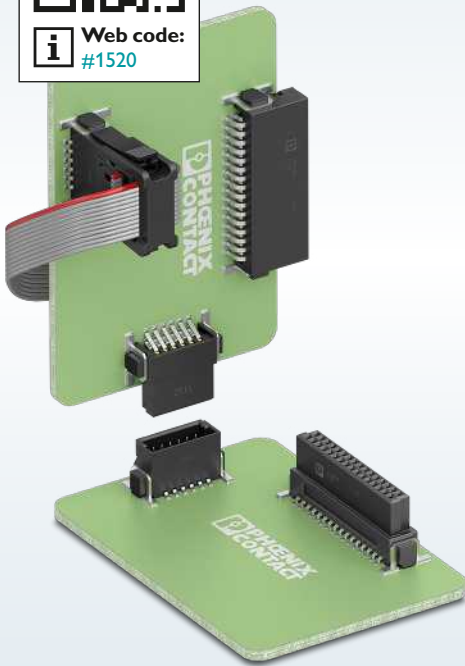

Unshielded FR 1,27

- Flexible board-to-board and wire-to-board connections
- 1.27 mm pitch
- High contact density from 6- to 100-pos.
- Stack heights from 8 to 13.8 mm
- Data transmission up to 28 Gbps



 **Web code:**
#2658



 **Web code:**
#2659

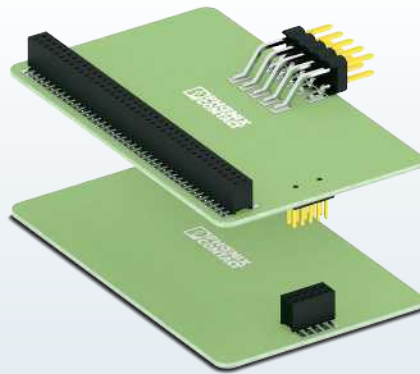

FQ 1,27 / FQ 2,54

- Flexible board-to-board connections
- 1.27 mm and 2.54 mm pitch
- High contact density from 10- to 80-pos.
- Various stack heights

Contents

Applications	4
System overview	6
Data transmission	8
FS 0,635 series	12
FP 0,8 series	18
FR 1,27 series	28
FQ 1,27 / FQ 2,54 series	38
Implement additional PCB connections with the COMBICON portfolio	42
Groundbreaking data connectors for smart networks	44
Excellent services	46

The right connection for flexible device design

The high-position FINEPITCH series provides the ideal solution for industrial-grade PCB connections. You have maximum flexibility when it comes to arranging the PCBs in your device. The wide range of FINEPITCH products includes various board-to-board connector types for space-saving signal and data transmission. In addition, the shielded versions offer excellent EMC properties.

i Web code: #2069

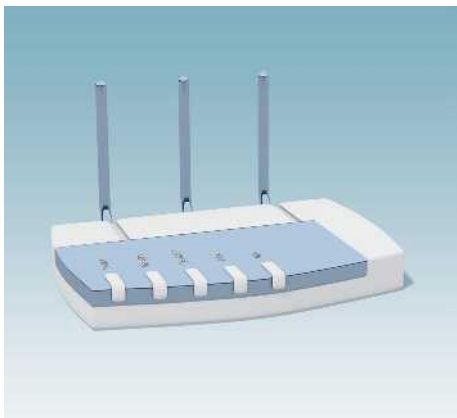

I/Os



PLCs



Frequency converters

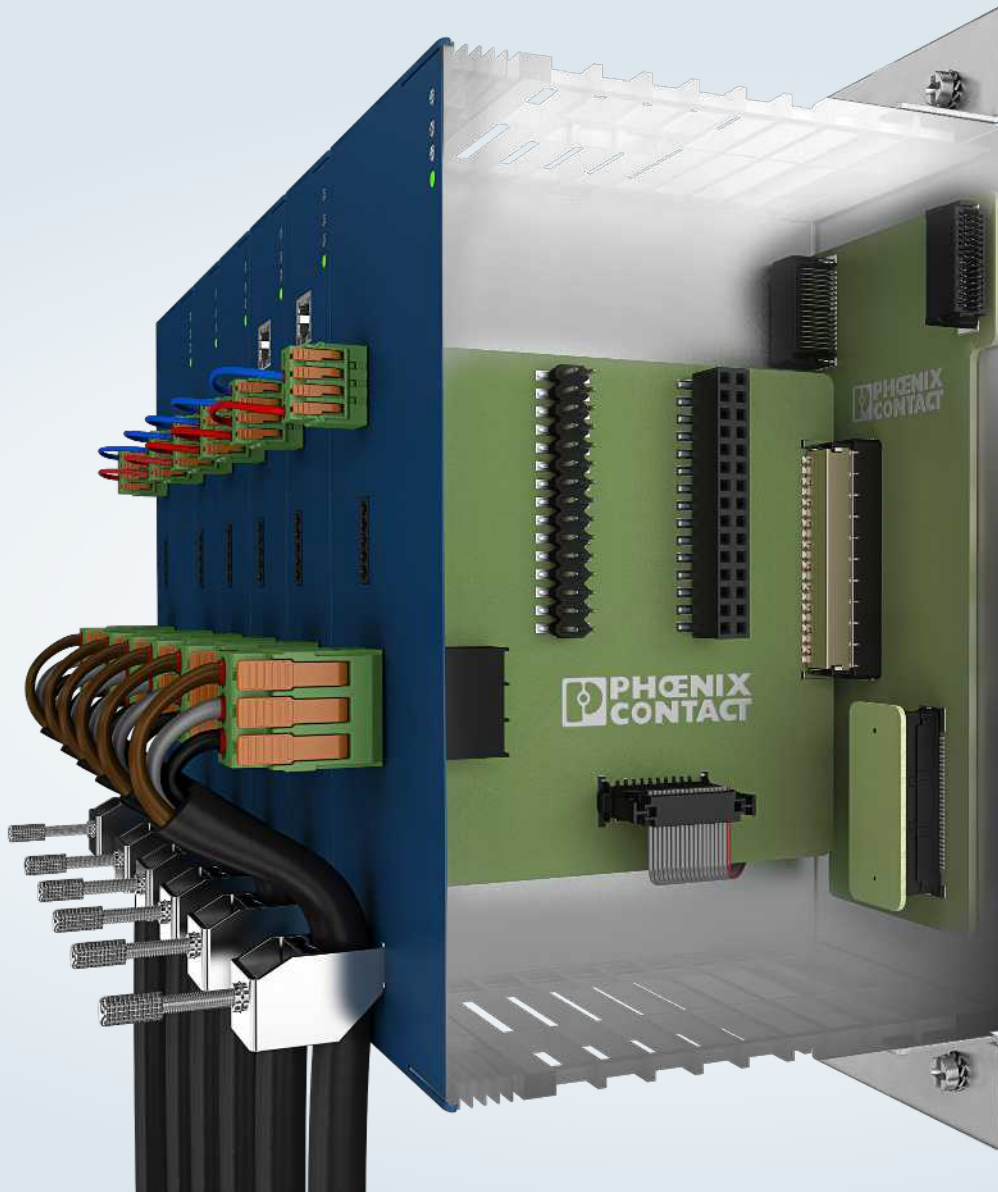

Controllers

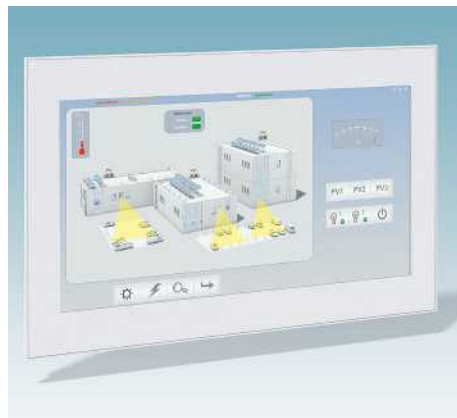

HMIs



Sensors

Connections for various requirements

The FINEPITCH series portfolio features a range of different board-to-board connector types. From cost-optimized pin headers and sockets, to commercially available PCB connectors with double contacts, to miniature PCBs connectors optimized for data transmission with a slim single-break or robust ScaleX contact system, you will find the right board-to-board connection for your application.

Contact technologies at a glance

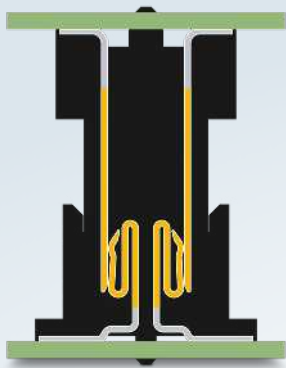

FS 0,635 with narrow, single-beam contacts

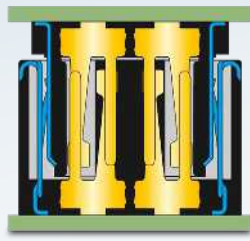

FP 0,8 with the innovative ScaleX contact system

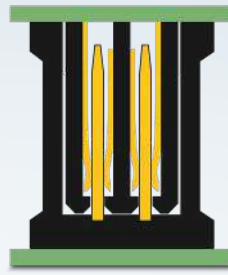

FP 1,27 with commercially available double contacts

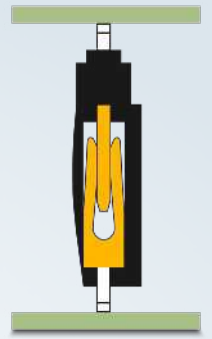

FQ series pin and base strips

PCB arrangements at a glance

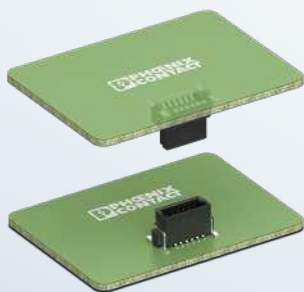

Mezzanine (sandwich arrangement)



Orthogonal (90°, mother-daughter arrangement)



Coplanar (head-to-head arrangement, extender card)

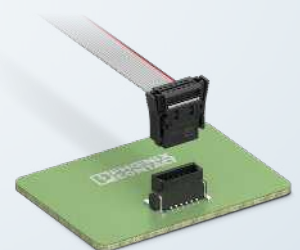

Ribbon cable connection (wire-to-board)

Overview of possible connector arrangements

		 ScaleX	 ScaleX					
	FS 0,635	FP 0,8 Shielded	FP 0,8 Unshielded	FR 1,27	FQ 1,27	FQ 2,54		
Number of positions	20, 40, 60, 80	12, 20, 32, 52, 80	12, 20, 32, 52, 80	6, 12, 16, 20, 26, 32, 40, 50, 68, 80, 100	10, 20, 30, 50, 80	10, 20, 30, 50, 80		
Stack height	Mezzanine							
6.00	6.0 mm ... 6.6 mm	6.0 mm ... 21 mm	6.0 mm ... 21 mm					
6.50								
7.00						6.2 mm ... 7.5 mm		
7.50								
8.00						8.0 mm ... 13.8 mm		
8.50								
9.00	9.0 mm ... 9.6 mm							
9.50								
10.00	10.0 mm ... 10.6 mm							
10.50								
11.00								
11.50								
12.00	12.0 mm ... 12.6 mm							
12.50								
13.00								
13.50								
14.00								
14.50								
15.00	15.0 mm ... 15.6 mm						Further pin lengths on request	13.6 mm ... 14.9 mm
15.50								
16.00	16.0 mm ... 16.6 mm							
16.50								
17.00								
17.50								
18.00								
18.50								
19.00								
19.50								
20.00								
20.50								
21.00								
	Angled (orthogonal, coplanar)							
		Available	Available	Available		Available		
	Flat-ribbon cable							
				Available				

High-speed data transmission with FINEPITCH board-to-board connectors

The FR 1,27, FS 0,635, and FP 0,8 series board-to-board connectors in particular are designed for high-frequency data transmission. The three series enable the even diffusion of the electromagnetic waves, ensuring that excellent signal integrity is achieved even at high frequencies.

The data transmission properties vary depending on the PCB arrangement and combination of items.

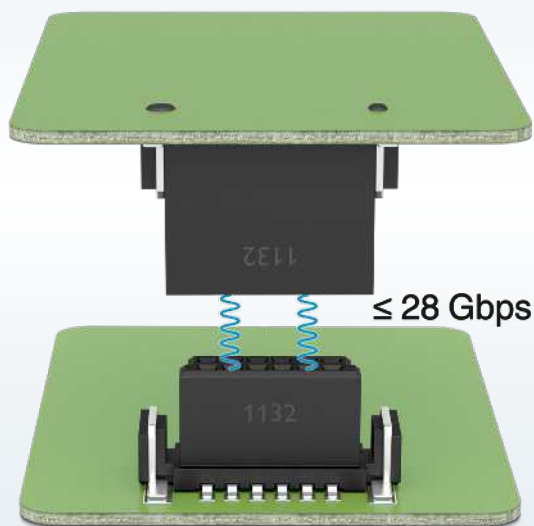

FR 1,27 series

Depending on the item combination, bandwidths up to 14 GHz and data rates up to 28 Gbps are possible with the FR 1,27 series mezzanine and angled board-to-board connectors.

Further information starting on page 28

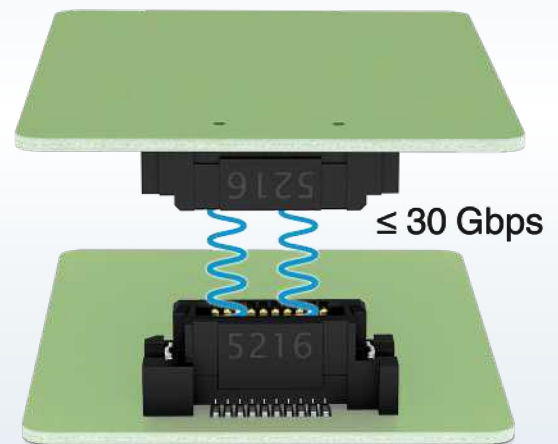

FS 0,635 series

Depending on the item combination, bandwidths up to 15 GHz and data rates up to 30 Gbps are possible with the FR 0,635 series mezzanine board-to-board connectors.

Further information starting on page 12

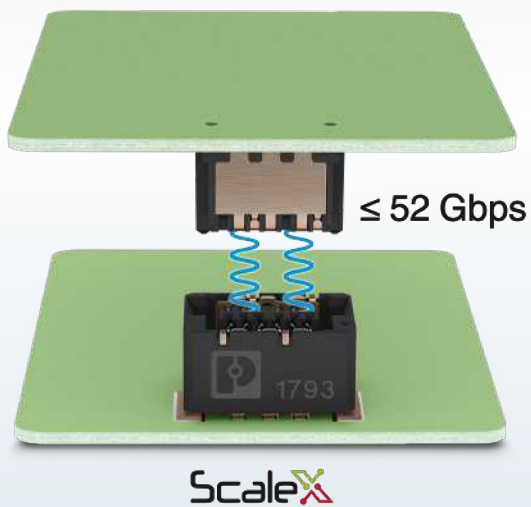

FP 0,8 series

Depending on the item combination, bandwidths up to 26 GHz and data rates up to 52 Gbps are possible with the FP 0,8 series mezzanine and angled board-to-board connectors.

Further information starting on page 18

High signal integrity

Achieve high signal integrity through innovative products and comprehensive design-in support: Our engineers at Phoenix Contact work every day to optimize data connectors for Industry 4.0. We would be pleased to discuss individual applications of our FINEPITCH board-to-board connectors with customers and evaluate possible solutions.

This brochure takes a closer look at selected configurations as examples. For an individual consideration of data transmission in the respective application, S-parameters for your own simulation are also provided on request.

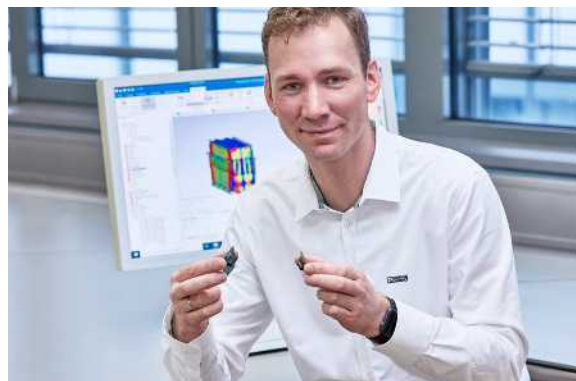

Simulation of data transmission characteristics with cutting-edge software tools

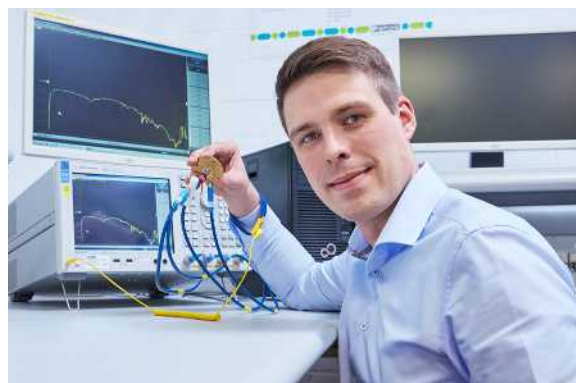

Measurement of data transmission properties in our accredited laboratories

Basics of data transmission

Types of data transmission

The most common method of data transmission is to use differential pairs. Here, two adjacent contacts are used in which two separate pulses switch the signal at the same time.

Single-ended signals are just as common as differential data transmission. A single contact transmits the signal in the process.

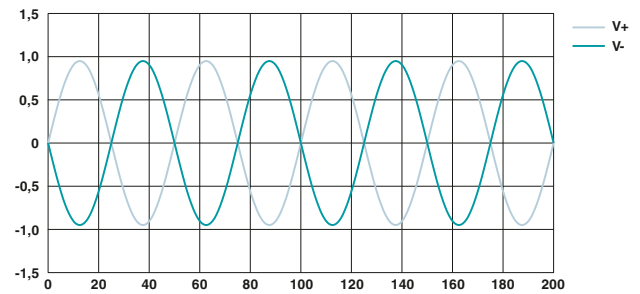

High-speed data transmission

The FINEPITCH board-to-board connectors are designed for high-frequency data transmission. Common parameters are considered for the individual evaluation of the data transmission quality. The adjacent diagram illustrates the standard insertion loss, near-end crosstalk (NEXT), far-end crosstalk (FEXT), and return loss evaluation parameters for data transmission.

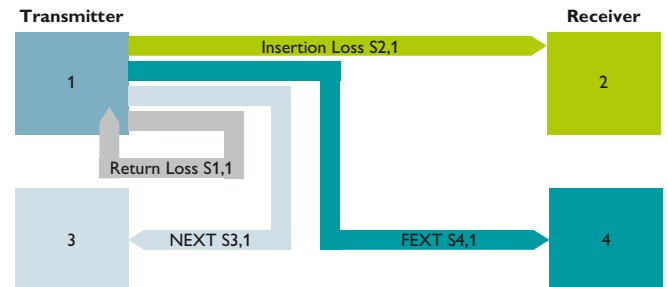

Insertion loss

Insertion loss indicates the attenuation of the signal level during data transmission from the transmitter to the receiver.

The objective is to minimize insertion loss to the extent possible. The potential bandwidth of a board-to-board connection results from the frequency at which the insertion loss reaches the value of -3dB for the first time. An attenuation of -3 dB corresponds to a 70% reduction of the signal strength.

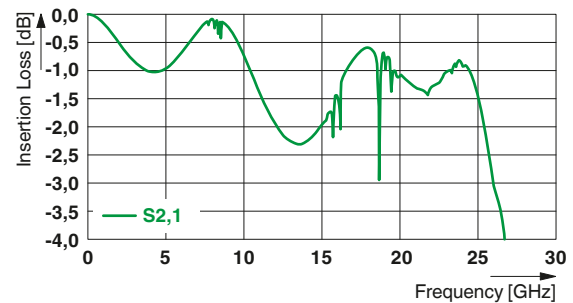

Example: FP 0,8/...-FV-SH 7,85 with FP 0,8/...-MV-SH 2,65, differential pair, 12 mm stack height, 100 Ω impedance environment

Data rate

The maximum data rate can be derived from the maximum bandwidth. As such, assuming binary signal transmission, the maximum data rate in bps is twice the value of the bandwidth (e.g., bandwidth = 26 GHz → maximum data rate = 52 Gbps). The attenuation behavior and, consequently, also the maximum data rate vary depending on the combination of items used. So, in addition to the nominal data rate per series (e.g., 16 Gbps with FP 0,8), there is a maximum possible data rate with the appropriate configuration pairing (e.g., 52 Gbps with FP 0,8).

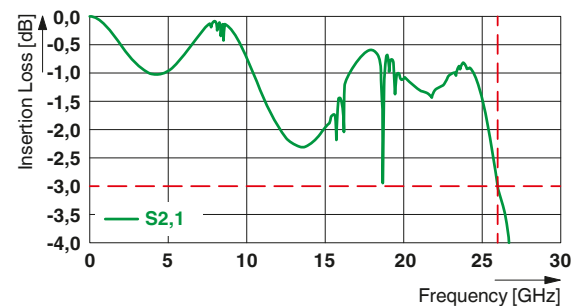

Reading the bandwidth at the first intersection of the attenuation curve with the -3 dB axis

Crosstalk

Crosstalk (X-talk) refers to the interference caused by the data transmission of or on adjacent contacts. A distinction is made between near-end crosstalk (NEXT) on the transmitter side and far-end crosstalk (FEXT) on the receiver side. Crosstalk is minimized by increasing the contact spacing and by assigning adjacent contacts as ground pins.

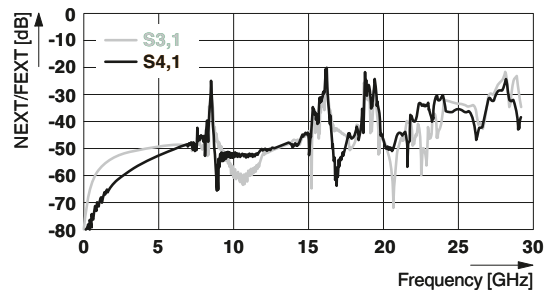

Example: FP 0,8/...-FV-SH 7,85 with FP 0,8/...-MV-SH 2,65, differential pair, 12 mm stack height, 100 Ω impedance environment

Impedance

Impedance is a frequency-dependent resistance during data transmission. To avoid reflections, the impedances of the PCBs and the components installed on them must be coordinated. The FINEPITCH board-to-board connectors are optimized for impedance environments of 100 Ω with differential pairs or 50 Ω with single-ended assignments. The diagram on the right shows an example of the impedance curve for various pulse rise times.

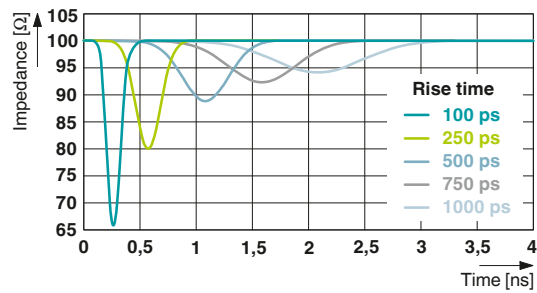

Return loss

Return loss refers to the extent to which back reflection to the signal source is attenuated in the transmission path. The goal is to keep the strength of the back-reflected signals low – as such, a strong return loss is desirable.

The return loss behavior is shown here as an example. Diagrams for other combinations of items are available on request.

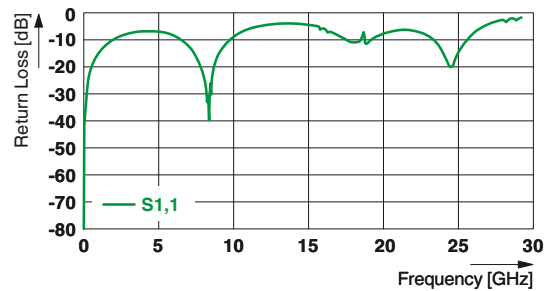

Example: FP 0,8/...-FV-SH 7,85 with FP 0,8/...-MV-SH 2,65, differential pair, 12 mm stack height, 100 Ω impedance environment

Standards and protocols

FINEPITCH board-to-board connectors are characterized by high flexibility in terms of application areas. The board-to-board connectors can be used for a wide range of different data transmission protocols and standards.

The diagrams shown in this brochure each refer to an impedance environment of 100 Ω , as used in many applications. Depending on the data transfer protocol used, other impedance environments are required, e.g., 90 Ω for USB 2.0 or 85 Ω for USB 3.0. Corresponding illustrations are available on request.

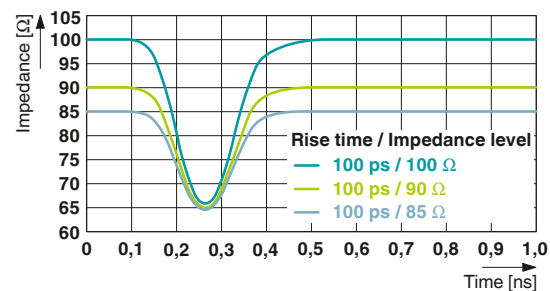

Example: FP 0,8/...-FV-SH 7,85 with FP 0,8/...-MV-SH 2,65, differential pair, 12 mm stack height, different impedance environments

Compact FS 0.635 series board-to-board connectors

The space-saving board-to-board connectors in the FS 0.635 series enable mezzanine PCB arrangements with high-speed data transmission rates up to 30 Gbps. A range of position numbers and stack heights supports a high degree of device design freedom.

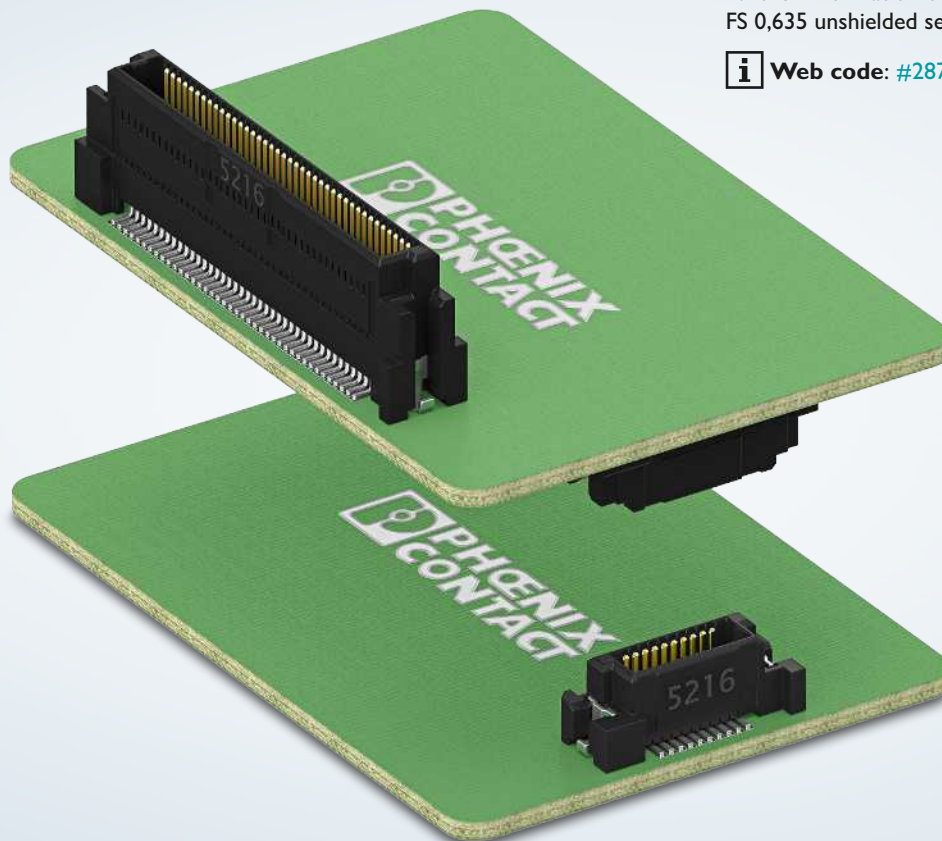

Further information on the FS 0,635 unshielded series:

i Web code: [#2879](#)

FS 0,635 series – advantages at a glance



Design-in support during device development

Integration of M-CAD-/E-CAD data and free sample service.

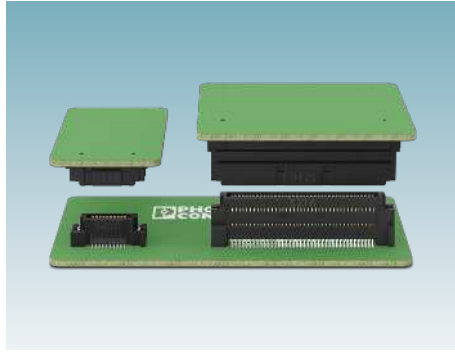

Comprehensive portfolio in all stack heights

Four different numbers of positions per stack height.

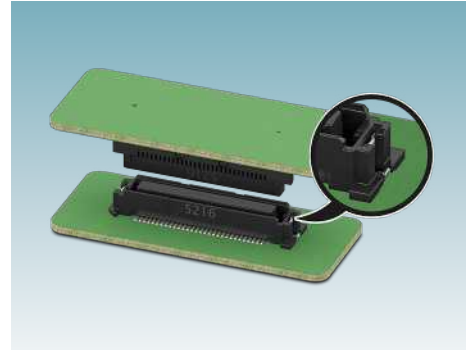

Easy mating

Integrated keyways and tolerance compensation ensure error-free production.

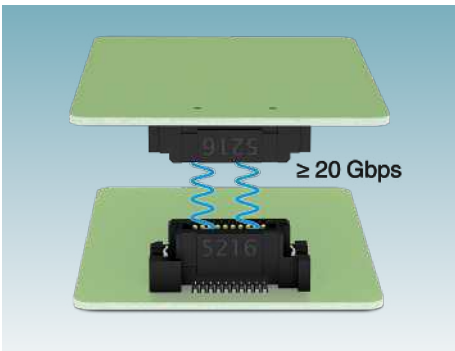

Data rates ≥ 20 Gbps

With exceptional signal integrity, the FS 0,635 series offer high-speed data transmission up to 30 Gbps for a wide range of applications.

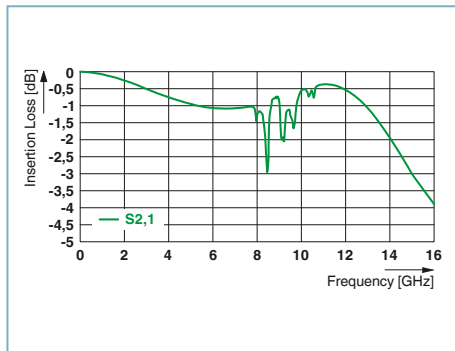

Our service: customer-specific simulations

Customer-specific simulations for data integrity ensure time savings during the development process.

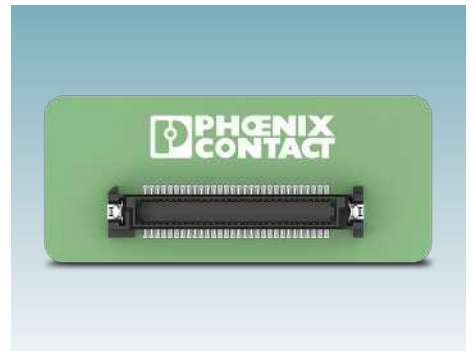

Visible solder contacts

The contacts are routed under the housing and enable automatic optical inspection (AOI).

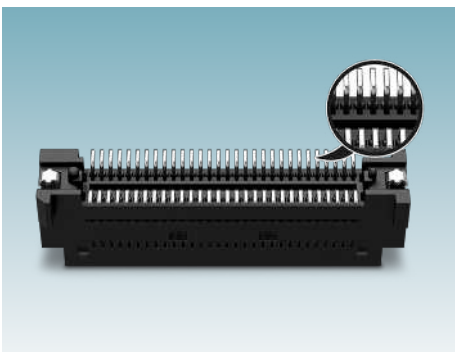

Process-reliable soldering

The FS 0,635 series board-to-board connectors feature a coplanarity of ≤ 0.12 mm.

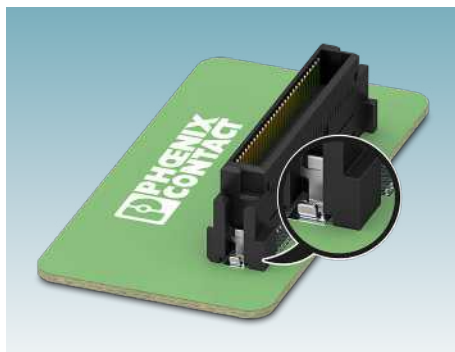

Stable soldering

Anchor metals ensure that the connection to the PCB is mechanically stable.

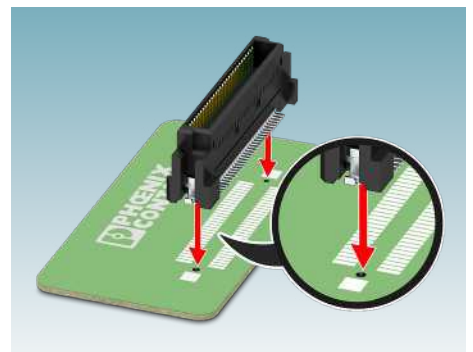

Securely positioned

Positioning pins on the bottom ensure secure positioning on the PCB.

FS 0,635 series – data transmission properties

High-speed data transmission

The FS 0,635 series is ideally suited for high-speed data transmissions up to 30 Gbps. Excellent signal integrity is achieved even at high frequencies up to 15 GHz.

The following diagrams illustrate the data transmission properties of the smallest and largest possible stack height in assignments with differential pairs and ground pins in the following order per contact row: G, S, S, G, S, S, G.

Additional diagrams as well as S-parameters for your own simulations are available on request.

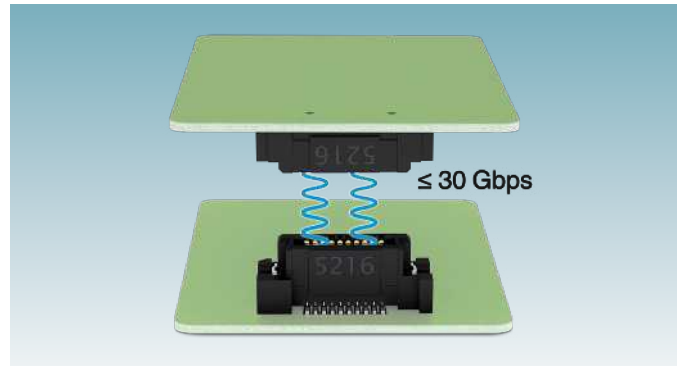

Insertion loss

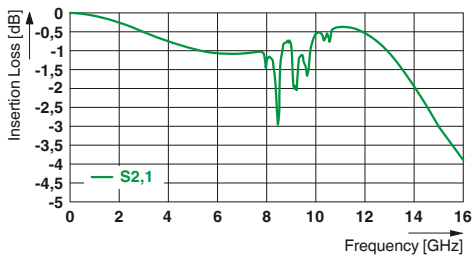

FS 0,635/...-FV-R- 4,0 with FS 0,635/...-MV-R- 5,0, differential pair, 6.0 mm stack height

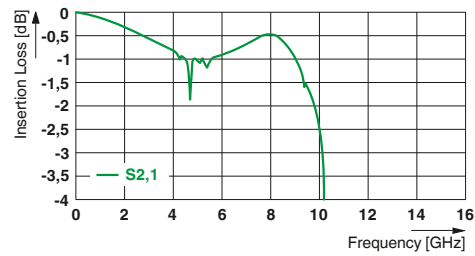

FS 0,635/...-FV-R-10,0 with FS 0,635/...-MV-R- 9,0, differential pair, 16.6 mm stack height

Crosstalk

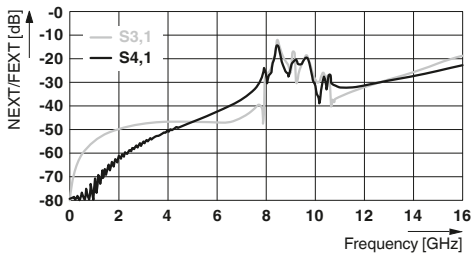

FS 0,635/...-FV-R- 4,0 with FS 0,635/...-MV-R- 5,0, differential pair, 6.0 mm stack height

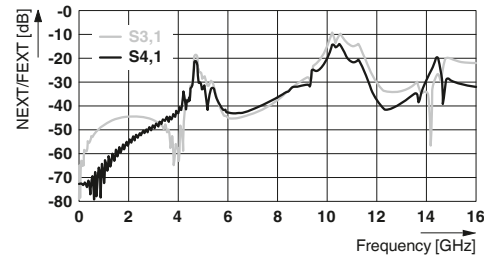

FS 0,635/...-FV-R-10,0 with FS 0,635/...-MV-R- 9,0, differential pair, 16.6 mm stack height

Impedance

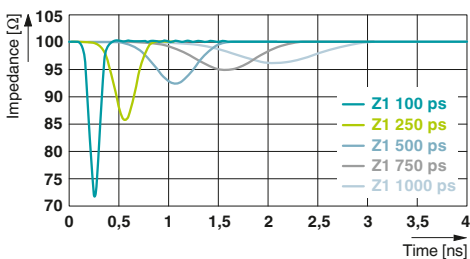

FS 0,635/...-FV-R- 4,0 with FS 0,635/...-MV-R- 5,0, differential pair, 6.0 mm stack height

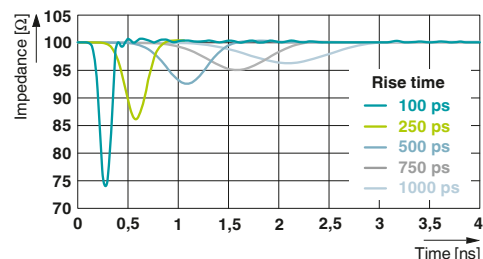

FS 0,635/...-FV-R-10,0 with FS 0,635/...-MV-R- 9,0, differential pair, 16.6 mm stack height

FS 0,635 series – technical data

General technical data		Standards/note
Pitch	0.635 mm	
Number of positions	20, 40, 60, 80	
Data transmission speed	Up to 30 Gbps	
Nominal current at full current, 60-pos. (at 20°C)	0.5 A (per contact)	IEC 60512-5-2:2002
Insulation resistance	Min. 1 GΩ	IEC 60512-3-1:2002
Contact resistance (depending on stack height)	6.0 mm ... 6.6 mm: ≤40 mΩ 9.0 mm ... 9.6 mm: ≤50 mΩ 10.0 mm ... 10.6 mm: ≤50 mΩ 12.0 mm ... 12.6 mm: ≤60 mΩ 15.0 mm ... 15.6 mm: ≤70 mΩ 16.0 mm ... 16.6 mm: ≤70 mΩ	IEC 60512-2-1:2002
Test voltage	500 V AC	IEC 60512-4-1:2003
Air clearances and creepage distances	Min. 0.19 mm	
Temperature limits during operation	-55°C to +125°C	IEC 60664-1:2020
Rated voltage (I/1)	125 V	IEC 60664-1:2020
Rated surge voltage (I/1)	0.8 kV	
Insertion and withdrawal force per contact	≤0.7 N	
Approval	UL 1977 / CSA C22.2 No 182-3	
Environmental and durability tests		
Service life	50 insertion cycles	IEC 60512-9-1:2010
Oscillation, sinusoidal	10 ... 2000 Hz, 20g	IEC 60512-6-4:2002
Contact interference during oscillation, sinusoidal	<1 μs	IEC 60512-2-5:2003
Shocks, half-sinusoidal	50g, 11 ms	IEC 60512-6-3:2002
Contact interference during shocks, half-sinusoidal	<1 μs	IEC 60512-2-5:2003
Information on metal parts		
Note	WEEE/RoHS-compliant	
Live metal parts	Cu alloy	
Surface of contact area	Ni, Au	
Surface of soldering area	Sn	
Information on insulation material		
Insulation material and group	LCP, IIIb	
Color	Black	
Resistance to creepage	CTI 150	DIN EN 60112 (VDE 030311)
Flammability rating in accordance with UL 94	V0	
Processing note		
Process	SMD soldering	Based on IPC/JEDEC J-STD-020D.1:2008-03
Moisture sensitivity level	MSL 1	
Coplanarity	≤0.1 mm (20-, 40-, and 60-pos.) ≤0.12 mm (80-pos.)	
Packaging	Tape-on-reel	

FS 0,635 series – installation instructions

Stack heights

The FS 0,635 series male and female connector strips enable various stack heights in the range from 6.0 mm to 16.6 mm. The stack height describes the distance between two PCBs overlapping in parallel. The stack heights have a permissible height tolerance of 0.6 mm. The adjacent table lists the possible PCB clearances. Further stack heights are planned for the coming years.

Stack height	Male connector strip	Female connector strip
6.0 mm ... 6.6 mm	FS 0,635/...-MV-R- 5,0	FS 0,635/...-FV-R- 4,0
9.0 mm ... 9.6 mm	FS 0,635/...-MV-R- 8,0	FS 0,635/...-FV-R- 4,0
10.0 mm ... 10.6 mm	FS 0,635/...-MV-R- 9,0	FS 0,635/...-FV-R- 4,0
12.0 mm ... 12.6 mm	FS 0,635/...-MV-R- 5,0	FS 0,635/...-FV-R-10,0
15.0 mm ... 15.6 mm	FS 0,635/...-MV-R- 8,0	FS 0,635/...-FV-R-10,0
16.0 mm ... 16.6 mm	FS 0,635/...-MV-R- 9,0	FS 0,635/...-FV-R-10,0

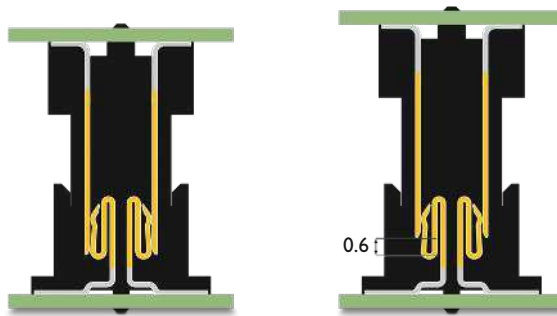

Minimum and maximum PCB clearance with wipe length

Tolerance compensation

During the plugging process, the connectors have a position tolerance of ± 0.5 mm in the longitudinal and transverse directions. The geometry also enables an inclination tolerance of $\pm 10^\circ$ during connection, and $\pm 2^\circ$ when connected. These flexible tolerance compensations enable a flexible design of the PCB arrangement.

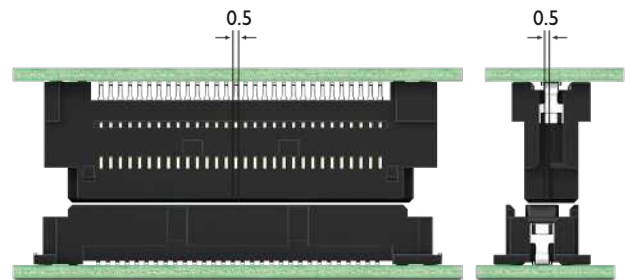

Center offset

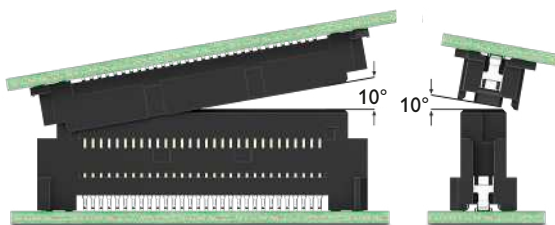

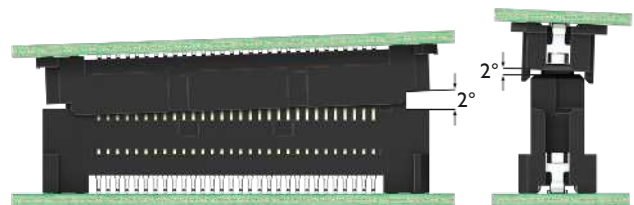

Inclination tolerance when connecting





Inclination tolerance when connected

Male connector strips

	Height 5.0 mm / base height 2.0 mm		Height 8.0 mm / base height 5.0 mm		Height 9.0 mm / base height 6.0 mm	
						
Number of positions	Type	Item no.	Type	Item no.	Type	Item no.
20	FS 0,635/ 20-MV-R- 5,0	1332120	FS 0,635/ 20-MV-R- 8,0	1332124	FS 0,635/ 20-MV-R- 9,0	1332195
40	FS 0,635/ 40-MV-R- 5,0	1332121	FS 0,635/ 40-MV-R- 8,0	1332125	FS 0,635/ 40-MV-R- 9,0	1332196
60	FS 0,635/ 60-MV-R- 5,0	1332122	FS 0,635/ 60-MV-R- 8,0	1332126	FS 0,635/ 60-MV-R- 9,0	1332197
80	FS 0,635/ 80-MV-R- 5,0	1332123	FS 0,635/ 80-MV-R- 8,0	1332127	FS 0,635/ 80-MV-R- 9,0	1332198

Female connector strips

	Height 4.0 mm		Height 10.0 mm	
				
Number of positions	Type	Item no.	Type	Item no.
20	FS 0,635/ 20-FV-R- 4,0	1331962	FS 0,635/ 20-FV-R-10,0	1334089
40	FS 0,635/ 40-FV-R- 4,0	1333897	FS 0,635/ 40-FV-R-10,0	1334090
60	FS 0,635/ 60-FV-R- 4,0	1333898	FS 0,635/ 60-FV-R-10,0	1334091
80	FS 0,635/ 80-FV-R- 4,0	1333899	FS 0,635/ 80-FV-R-10,0	1334092

Robust connections thanks to FP 0,8 with ScaleX technology

The double-sided ScaleX contact system of the FP 0,8 series enables particularly robust PCB connections. It also supports high-speed data rates up to 52 Gbps. The shielding ensures excellent electromagnetic behavior. By extending the portfolio with higher female connector strips, additional stack heights are possible. We have thus created a unique, flexible portfolio with unshielded and shielded board-to-board connectors for mezzanine, orthogonal, and coplanar PCB arrangements.



Further information on the FP 0,8 shielded series:

i Web code: #2050

ScaleX

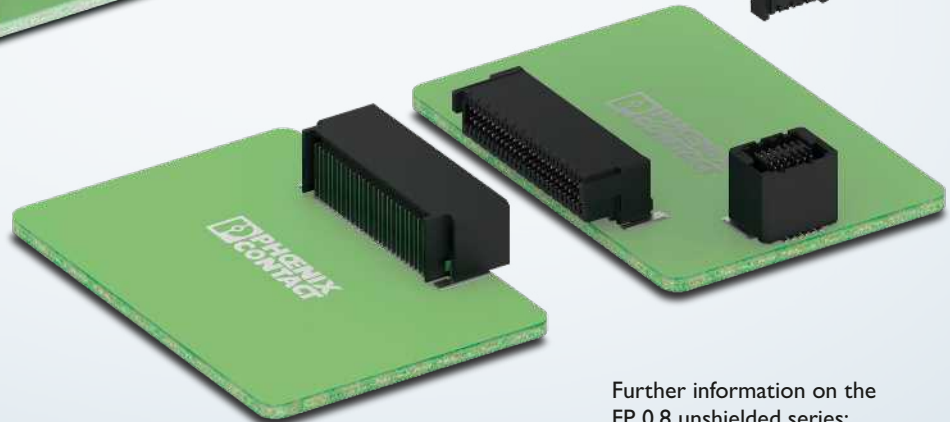

Further information on the FP 0,8 unshielded series:

i Web code: #2330

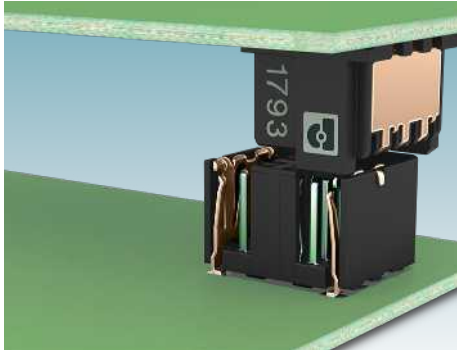

Robust insertion with high tolerance compensation

The housing geometry and hermaphroditic double contact ensure the compensation of insertion and PCB tolerances.

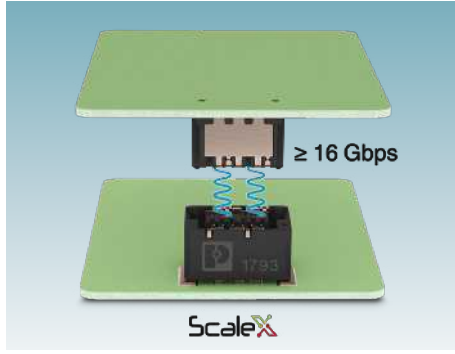

High data rate ≥ 16 Gbps

The FP 0,8 series offers signal integrity with data rates up to 52 Gbps.

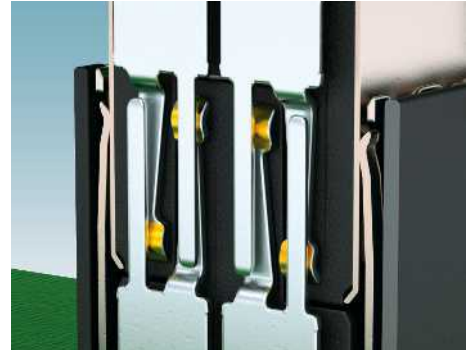

Reliable connection

The double contact enables a variable wipe length of 1.5 mm and an additional contact overlap of 0.8 mm for safety.

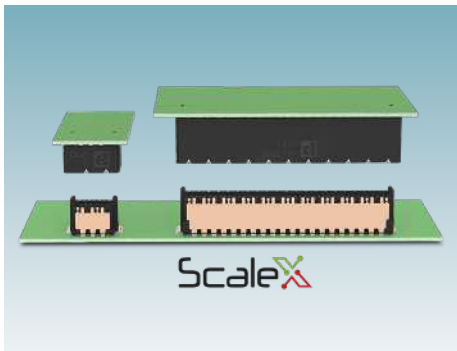

Flexible device design

Stack heights from 6 to 21 mm enable a great deal of freedom for the device design.

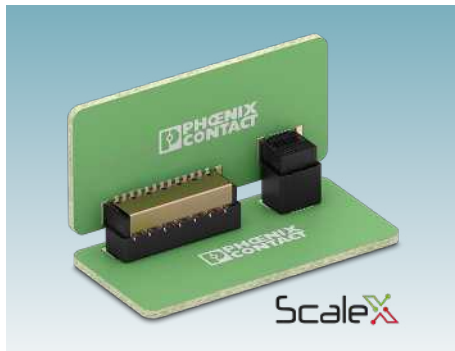

Multiple connections

The high level of flexibility and tolerance compensation enable the printed circuit boards to be connected to several connectors at the same time.

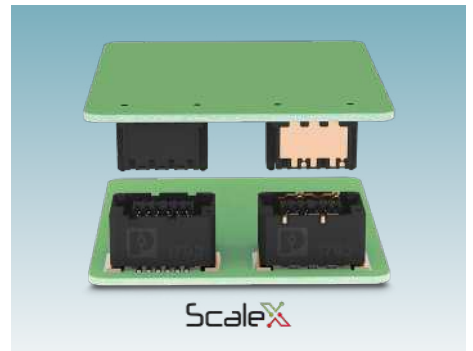

High variability in just one range

With their equal tolerances, stack heights, and mechanical properties, the shielded and unshielded versions enable a wide range of applications.

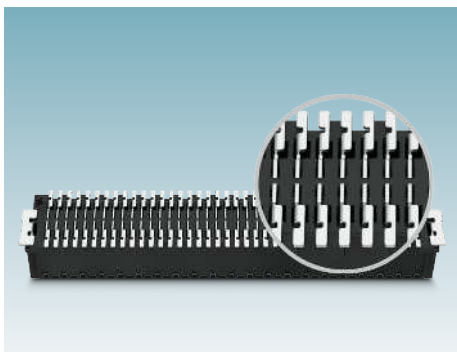

Automatic quality control

Unshielded contacts are routed under the housing, and enable automatic optical inspection (AOI).

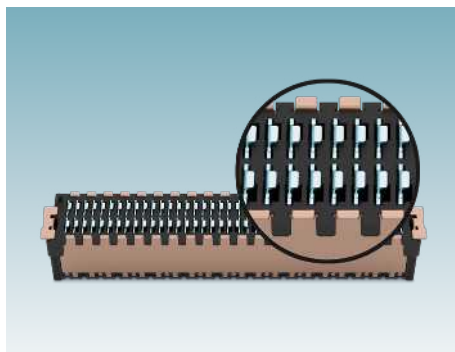

High EMC protection

Shielded contacts are located underneath the component and are surrounded by the shield contacts. An inspection by means of CT scan is possible.

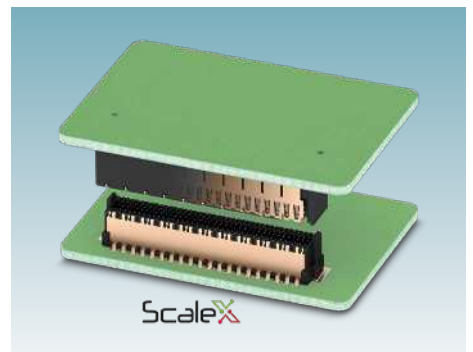

Additional protection with EMC shielding

The shielded versions have excellent protection against electromagnetic interference.

Innovative contact system

The FP 0,8 series with ScaleX technology features a unique double contact. The contacts are designed to be hermaphroditic and therefore consist of a male and a female element. This enables vibration-resistant connection in a very tight space. The contacts have gull-wing solder pins, which are ideal for automatic soldering processes.

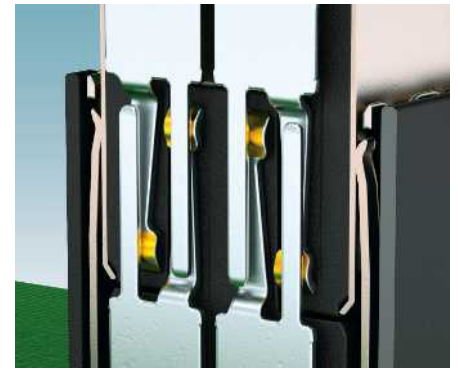

Robustness and tolerance compensation

The ScaleX contact system enables a housing geometry in which the contacts are protected against damage in the event of mismatching. This geometry also enables the mating partners to position themselves together.

Reliable mating is ensured, even with a center offset of ± 0.7 mm and an inclination deviation of $\pm 5^\circ$.

When connected, a longitudinal and transverse positional deviation of ± 0.3 mm and an inclination deviation of $\pm 5^\circ$ is possible. Together with the wipe tolerance of 1.5 mm, the FP 0,8 series enables high flexibility in the printed circuit board design, e.g., for tolerance compensation within the entire process chain and for the multiple connection of two PCBs.

Normally, board-to-board connectors with a floating function are used in order to achieve such flexibility, but these require significantly more installation space on the PCB.

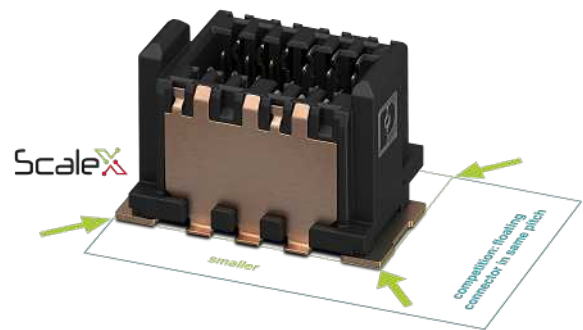

Space requirement compared that of a common floating connector

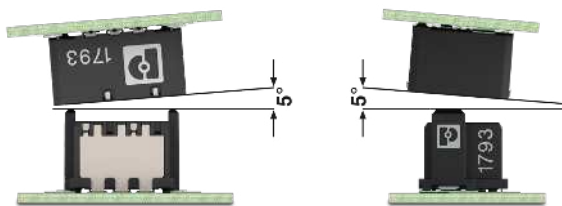

Inclination tolerance when connecting

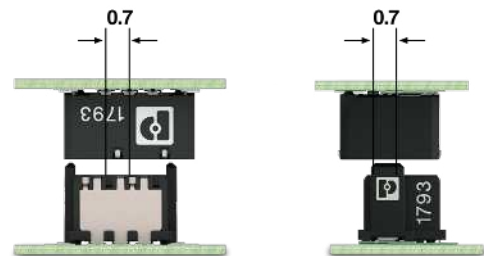

Center offset when plugging in

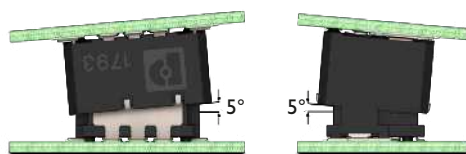

Inclination tolerance compensation when plugged in

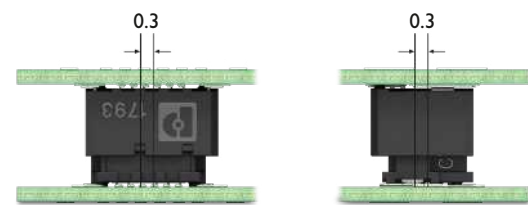

Position tolerance compensation when plugged in

Flexible device design

Various stack heights can be realized through the arrangement of vertical male and female connector strips. The stack height describes the clearance between two PCBs overlapping in parallel.

A range from 6 mm to 21 mm can be covered comprehensively with just three male and two female connector strips. Within this range, the mating partners provide a variable wipe length of 1.5 mm. The male connector strip is fully inserted into the female connector strip with the respective minimum PCB spacing. This minimizes product variance while simultaneously providing a high degree of flexibility for device design.

Stack height	Male connector strip	Female connector strip
6 mm ... 7.5 mm	FP 0,8/...-MV(-SH) 1,15	FP 0,8/...-FV(-SH) 4,85
7.5 mm ... 9 mm	FP 0,8/...-MV(-SH) 2,65	FP 0,8/...-FV(-SH) 4,85
9 mm ... 10.5 mm	FP 0,8/...-MV(-SH) 1,15	FP 0,8/...-FV(-SH) 7,85
10.5 mm ... 12 mm	FP 0,8/...-MV(-SH) 2,65	FP 0,8/...-FV(-SH) 7,85
12 mm ... 13.5 mm	FP 0,8/...-MV(-SH) 7,15	FP 0,8/...-FV(-SH) 4,85
13.5 mm ... 15 mm	FP 0,8/...-MV(-SH) 8,65	FP 0,8/...-FV(-SH) 4,85
15 mm ... 16.5 mm	FP 0,8/...-MV(-SH) 7,15	FP 0,8/...-FV(-SH) 7,85
16.5 mm ... 18 mm	FP 0,8/...-MV(-SH) 8,65	FP 0,8/...-FV(-SH) 7,85
18 mm ... 19.5 mm	FP 0,8/...-MV(-SH) 7,15	FP 0,8/...-FV(-SH) 10,85
19.5 mm ... 21 mm	FP 0,8/...-MV(-SH) 8,65	FP 0,8/...-FV(-SH) 10,85

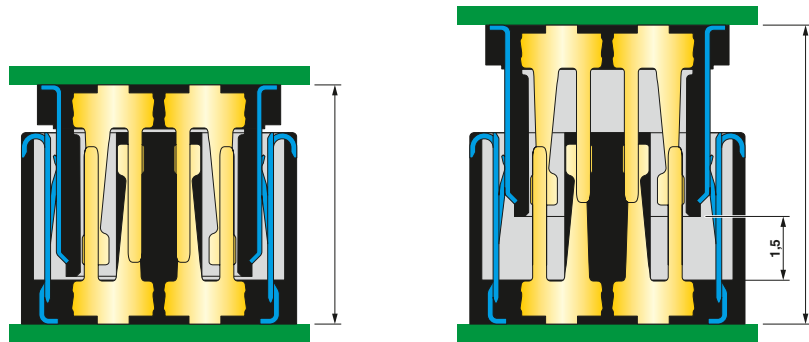

Minimum PCB spacing (left) and maximum PCB spacing (right) due to the wipe length

Secure contacting

The hermaphroditic double contacts have a safe coverage of 2.3 mm once the female and male connectors are fully connected.

This contact overlap refers to the contacting of the resilient contact area on the planar pin section. The finding area with the contact insertion chamfers is added to the ensured 2.3 mm.

A variable wipe length of 1.5 mm applies to each connector pair in order to offer flexible stack heights between 6 and 21 mm in the portfolio of male and female connectors. This wipe length was tested and approved in the laboratory as part of the item qualification process. When this wipe range is used, a contact reliability of 0.8 mm remains. This enables tilt tolerances in the connected state, for example.

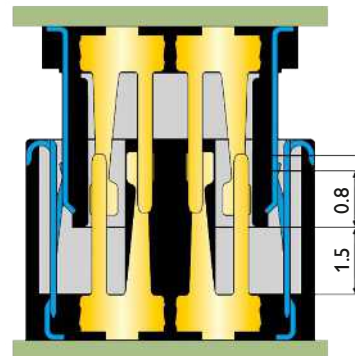

Areas of contacting the ScaleX contacts

Shielded vs. unshielded

Generally, the same data and signals can be transmitted through both shielded and unshielded connectors. Geometrically, the contacts in the standard versions have only a different design of the soldering surfaces. The shielded types have signal contacts with internal gull-wing soldering surfaces. They protrude from under the housing on the unshielded versions, enabling AOI control of soldering results. In contrast, the shielded types use CT or X-ray analysis, for example, to evaluate the soldering results.

In the diagrams of the behavior of insertion loss, return loss, and crosstalk commonly used for data transmission, these geometric differences do not result in any major deviation, as can be seen in the adjacent insertion loss example.

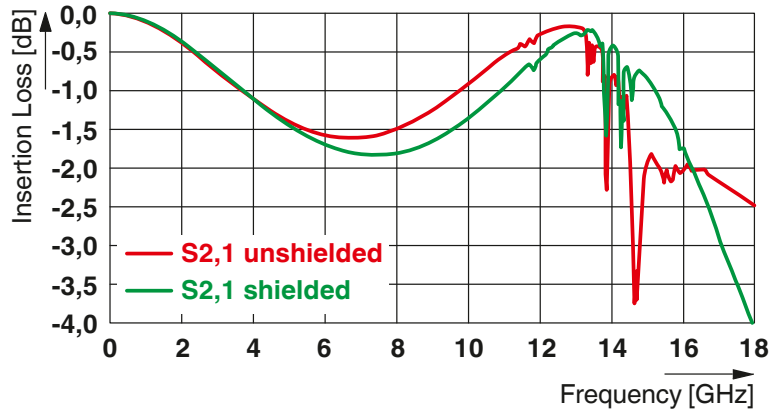

Insertion loss in comparison of shielded and unshielded board-to-board connection: FP 0,8/...-FV(-SH) 4,85 with FP 0,8/...-MV(-SH) 1,15, differential pair, 6.0 mm stack height

Power transmission of signal contacts

The nominal current for the FP 0,8 series board-to-board connectors is 1.7 A per contact. This nominal current results from the full current of the largest number of positions in the current carrying capacity test, taking into account the derating factor of 0.8. In the derating curves, the nominal current is usually read at 20 °C for board-to-board connectors.

Due to the lower total heating, there is a significantly higher current carrying capacity per pin both for the full current supply of smaller numbers of positions and for the partial current supply of individual contacts. Thus, depending on the application, significantly higher currents than 1.7 A per contact can be transmitted.

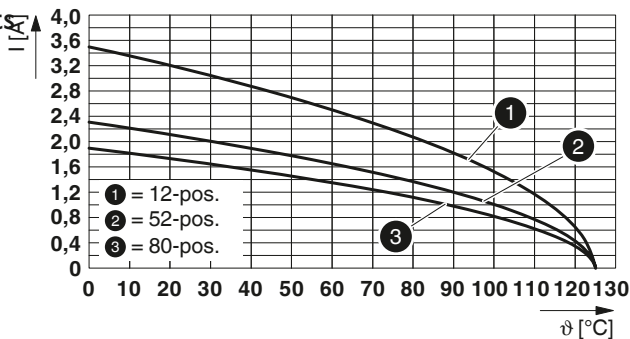

Current transmission with different numbers of positions using the example of FP 0,8/...-MV-SH 2,65 with FP 0,8/...-FV-SH 7,85

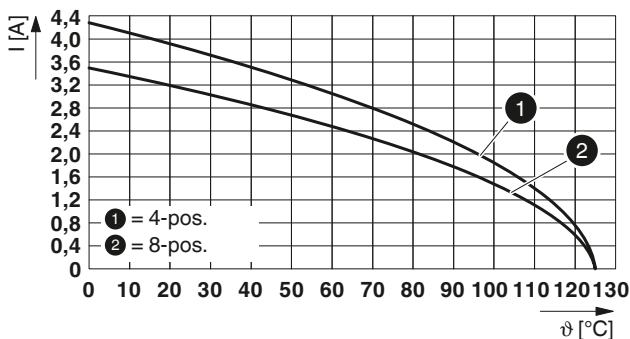

Current transmission with partial current flow using the example of FP 0,8/...-MV-SH 2,65 with FP 0,8/...-FV-SH 7,85

EMC and shielding

The shielded connectors have shrouds in longitudinal alignment with multiple solder feet at a 1.6 mm pitch. With a grounding of the outer contacts, 360° shielding is achieved. This can be seen in the illustration of the magnetic fields: The shielded design does not induce a field outside the shielding due to the internal high-frequency signal transmission, and the field of an external interfering signal does not propagate inside, thereby negatively influencing the signal

quality. The unshielded version is different. To maintain a high level of immunity of the signal contacts to the environment, the effects shown require shielded PCB connectors in many applications. This protects sensitive signals or effectively inhibits the intensity of strong interference sources. The shields of the FP 0,8 series board-to-board connectors are made of a copper-nickel-tin alloy and are therefore non-magnetic. Because of this characteristic,

they can be used in imaging evaluation systems, for example, such as magnetic resonance tomographs in the medical field.

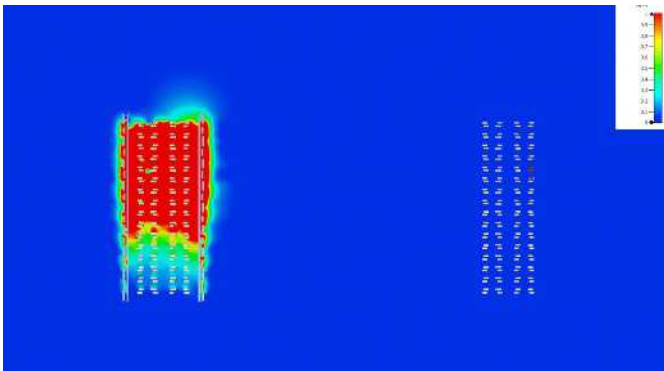

Electromagnetic field for single-ended signal in the shielded version

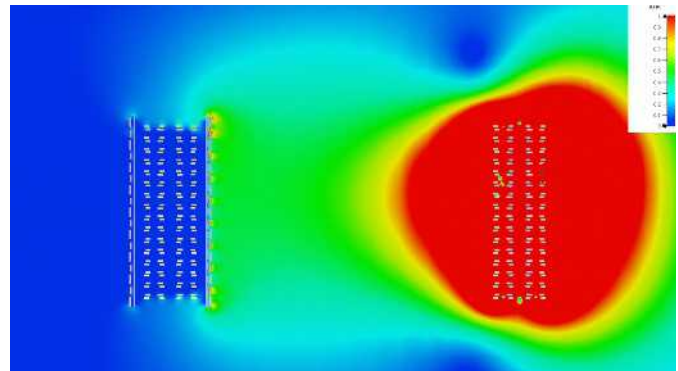

Electromagnetic field for single-ended signal in the unshielded version

Power transmission of shrouds

In addition to the characteristic function of shielding, the shrouds of the board-to-board connectors in the FP 0,8 series can also be used for power transmission.

This characteristically results in different current transfer capacities for each number of positions. As can be seen in the adjacent derating diagram using the example of FP 0,8/..-MV-SH 2,65 with FP 0,8/..-FV-SH 7,85, the current transmission per shield plate side for a 12-pos. board-to-board connection is around 10 A. For an 80-pos. board-to-board connection, around 16 A can be transmitted per shield plate side.

Theoretically, when the 80-pos. board-to-board connector FP 0,8/..-MV-SH 2,65 is fully loaded with FP 0,8/..-FV-SH 7,85, it is possible to transmit $2 \times 16 \text{ A} + 80 \times 1.7 \text{ A} = 168 \text{ A}$, taking into account currents of the signal contacts, which depend on the number of positions (see previous page).

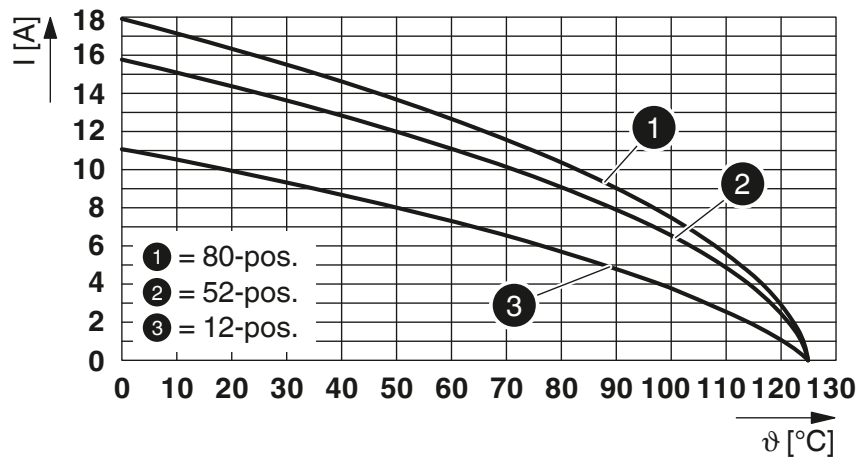

Current transmission of a shroud based on the example of FP 0,8/..-MV-SH 2,65 with FP 0,8/..-FV-SH 7,85

High-speed data transmission

The FP 0,8 series is ideally suited for high-speed data transmissions up to 52 Gbps. Excellent signal integrity is achieved even at high frequencies up to 26 GHz.

The following diagrams illustrate the data transmission properties of the smallest and largest possible stack height in assignments with differential pairs and ground pins in the following order per contact row: G, S, S, G, S, S, G.

Additional diagrams as well as S-parameters for your own simulations are available on request.

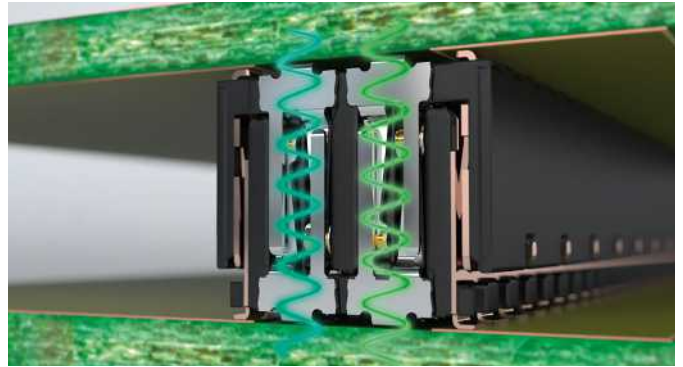

Insertion loss

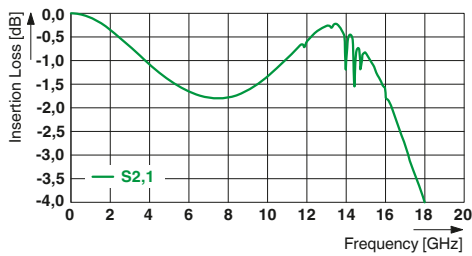

FP 0,8/...-FV-SH 4,85 mit FP 0,8/...-MV-SH 1,15, differential pair, 6.0 mm stack height

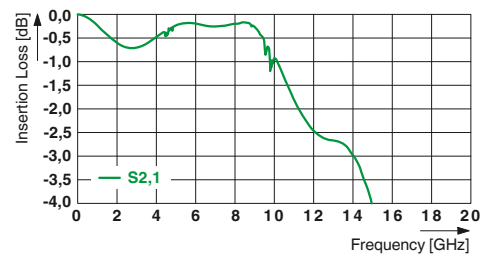

FP 0,8/...-FV-SH 10,85 mit FP 0,8/...-MV-SH 8,65, differential pair, 21.0 mm stack height

Crosstalk

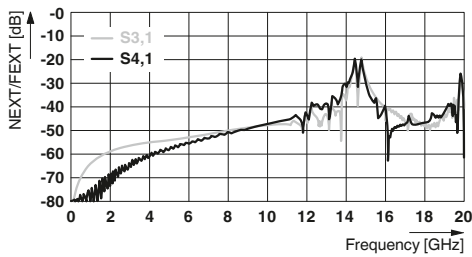

FP 0,8/...-FV-SH 4,85 mit FP 0,8/...-MV-SH 1,15, differential pair, 6.0 mm stack height

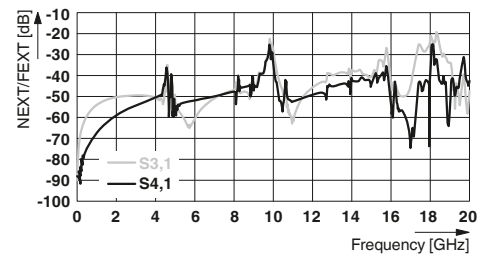

FP 0,8/...-FV-SH 10,85 mit FP 0,8/...-MV-SH 8,65, differential pair, 21.0 mm stack height

Impedance

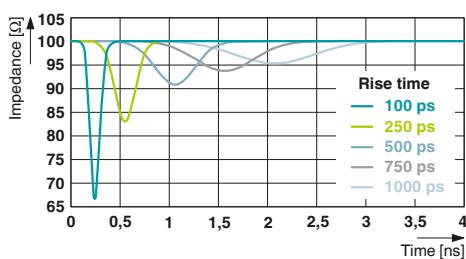

FP 0,8/...-FV-SH 4,85 mit FP 0,8/...-MV-SH 1,15, differential pair, 6.0 mm stack height

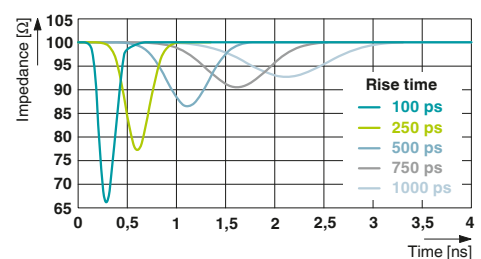



FP 0,8/...-FV-SH 10,85 mit FP 0,8/...-MV-SH 8,65, differential pair, 21.0 mm stack height

General technical data		Standards/note
Pitch	0.8 mm	
Number of positions	12, 20, 32, 52, 80	
EMC properties	Unshielded/shielded	
Data transmission speed	Up to 52 Gbps	
Nominal current at full current, 52-pos. (at 20°C)	1.7 A (per contact)	IEC 60512-5-2:2002
Insulation resistance	Min. 5 GΩ	IEC 60512-3-1:2002
Contact resistance	Max. 20 mΩ	IEC 60512-2-1:2002
Test voltage	500 V AC	IEC 60512-4-1:2003
Rated voltage (I/1)	125 V	IEC 60664-1:2020
Rated surge voltage (I/1)	0.8 kV	IEC 60664-1:2020
Air clearances and creepage distances	Min. 0.25 mm	
Temperature limits during operation	-55°C to +125°C	
Insertion and withdrawal force per contact	≤1.2 N	
Approval	UL 1977 / CSA C22.2 No 182-3	
Environmental and durability tests		
Service life	500 insertion cycles, performance level I	IEC 60512-9-1:2010
Oscillation, sinusoidal	10 ... 2000 Hz, 20g	IEC 60512-6-4:2002
Contact interference during oscillation, sinusoidal	<1 μs	IEC 60512-2-5:2003
Shocks, half-sinusoidal	50g, 11 ms	IEC 60512-6-3:2002
Contact interference during shocks, half-sinusoidal	<1 μs	IEC 60512-2-5:2003
Information on metal parts		
Note	WEEE/RoHS-compliant, free of whiskers	IEC 60068-2-82/JEDEC JESD 201
Live metal parts	Cu alloy	
Surface of contact area	Ni, Au	
Surface of soldering area	Sn	
Information on insulation material		
Insulation material and group	LCP, IIIb	
Color	Black	
Resistance to creepage	CTI 150	DIN EN 60112 (VDE 0303-11)
Flammability rating in accordance with UL 94	V0	
Processing note		
Process	SMD soldering	Based on IPC/JEDEC J-STD-020D.1:2008-03
Moisture sensitivity level	MSL 1	
Coplanarity	≤0.1 mm	
Packaging	Tape-on-reel	

Shielded								
Vertical male connector strip					Vertical female connector strip			
								
Number of positions	Base height 1.15 mm		Base height 2.65 mm		Installed height 4.85 mm		Installed height 7.85 mm	
	Type	Item no.	Type	Item no.	Type	Item no.	Type	Item no.
12	FP 0,8/ 12-MV-SH 1,15	1043786	FP 0,8/ 12-MV-SH 2,65	1043731	FP 0,8/ 12-FV-SH 4,85	1043710	FP 0,8/ 12-FV-SH 7,85	1043682
20	FP 0,8/ 20-MV-SH 1,15	1053586	FP 0,8/ 20-MV-SH 2,65	1053609	FP 0,8/ 20-FV-SH 4,85	1053612	FP 0,8/ 20-FV-SH 7,85	1053614
32	FP 0,8/ 32-MV-SH 1,15	1043787	FP 0,8/ 32-MV-SH 2,65	1043733	FP 0,8/ 32-FV-SH 4,85	1043711	FP 0,8/ 32-FV-SH 7,85	1043683
52	FP 0,8/ 52-MV-SH 1,15	1043789	FP 0,8/ 52-MV-SH 2,65	1043756	FP 0,8/ 52-FV-SH 4,85	1043713	FP 0,8/ 52-FV-SH 7,85	1043684
80	FP 0,8/ 80-MV-SH 1,15	1043790	FP 0,8/ 80-MV-SH 2,65	1043757	FP 0,8/ 80-FV-SH 4,85	1043714	FP 0,8/ 80-FV-SH 7,85	1043685
								
Number of positions	Base height 7.15 mm		Base height 8.65 mm		Installed height 10.85 mm			
	Type	Item no.	Type	Item no.	Type	Item no.		
12	FP 0,8/ 12-MV-SH 7,15	1154004	FP 0,8/ 12-MV-SH 8,65	1154119	FP 0,8/ 12-FV-SH 10,85	1154031		
20	FP 0,8/ 20-MV-SH 7,15	1154005	FP 0,8/ 20-MV-SH 8,65	1154120	FP 0,8/ 20-FV-SH 10,85	1154032		
32	FP 0,8/ 32-MV-SH 7,15	1154007	FP 0,8/ 32-MV-SH 8,65	1154121	FP 0,8/ 32-FV-SH 10,85	1154033		
52	FP 0,8/ 52-MV-SH 7,15	1154008	FP 0,8/ 52-MV-SH 8,65	1154122	FP 0,8/ 52-FV-SH 10,85	1154034		
80	FP 0,8/ 80-MV-SH 7,15	1154011	FP 0,8/ 80-MV-SH 8,65	1154123	FP 0,8/ 80-FV-SH 10,85	1154035		
								
Horizontal male connector strip					Horizontal female connector strip			
Number of positions	Type		Item no.		Type		Item no.	
12	FP 0,8/ 12-MH-SH		1043791		FP 0,8/ 12-FH-SH		1043722	
20	FP 0,8/ 20-MH-SH		1053615		FP 0,8/ 20-FH-SH		1053616	
32	FP 0,8/ 32-MH-SH		1043792		FP 0,8/ 32-FH-SH		1043723	
52	FP 0,8/ 52-MH-SH		1043793		FP 0,8/ 52-FH-SH		1043724	
80	FP 0,8/ 80-MH-SH		1043794		FP 0,8/ 80-FH-SH		1043725	

Unshielded

		Vertical male connector strip				Vertical female connector strip			
									
Number of positions	Base height 1.15 mm		Base height 2.65 mm		Installed height 4.85 mm		Installed height 7.85 mm		
	Type	Item no.	Type	Item no.	Type	Item no.	Type	Item no.	
12	FP 0,8/ 12-MV 1,15	1061725	FP 0,8/ 12-MV 2,65	1061696	FP 0,8/ 12-FV 4,85	1061643	FP 0,8/ 12-FV 7,85	1061580	
20	FP 0,8/ 20-MV 1,15	1061727	FP 0,8/ 20-MV 2,65	1061697	FP 0,8/ 20-FV 4,85	1061660	FP 0,8/ 20-FV 7,85	1061583	
32	FP 0,8/ 32-MV 1,15	1061728	FP 0,8/ 32-MV 2,65	1061698	FP 0,8/ 32-FV 4,85	1061662	FP 0,8/ 32-FV 7,85	1061584	
52	FP 0,8/ 52-MV 1,15	1061729	FP 0,8/ 52-MV 2,65	1061700	FP 0,8/ 52-FV 4,85	1061666	FP 0,8/ 52-FV 7,85	1061585	
80	FP 0,8/ 80-MV 1,15	1061730	FP 0,8/ 80-MV 2,65	1061704	FP 0,8/ 80-FV 4,85	1061667	FP 0,8/ 80-FV 7,85	1061586	
									
Number of positions	Base height 7.15 mm		Base height 8.65 mm		Installed height 10.85 mm				
	Type	Item no.	Type	Item no.	Type	Item no.			
12	FP 0,8/ 12-MV 7,15	1154017	FP 0,8/ 12-MV 8,65	1154012	FP 0,8/ 12-FV 10,85	1154075			
20	FP 0,8/ 20-MV 7,15	1154018	FP 0,8/ 20-MV 8,65	1154013	FP 0,8/ 20-FV 10,85	1154076			
32	FP 0,8/ 32-MV 7,15	1154022	FP 0,8/ 32-MV 8,65	1154014	FP 0,8/ 32-FV 10,85	1154077			
52	FP 0,8/ 52-MV 7,15	1154023	FP 0,8/ 52-MV 8,65	1154015	FP 0,8/ 52-FV 10,85	1154078			
80	FP 0,8/ 80-MV 7,15	1154024	FP 0,8/ 80-MV 8,65	1154016	FP 0,8/ 80-FV 10,85	1154128			

		Horizontal male connector strip		Horizontal female connector strip	
					
Number of positions	Type	Item no.	Type	Item no.	
12	FP 0,8/ 12-MH	1104548	FP 0,8/ 12-FH	1104540	
20	FP 0,8/ 20-MH	1104549	FP 0,8/ 20-FH	1104541	
32	FP 0,8/ 32-MH	1104550	FP 0,8/ 32-FH	1104542	
52	FP 0,8/ 52-MH	1104551	FP 0,8/ 52-FH	1104543	
80	FP 0,8/ 80-MH	1104552	FP 0,8/ 80-FH	1104544	

FR 1,27: your speed advantage in a 1.27 mm pitch

High-speed data transmission and time savings in the development process make a real difference. With the FR series board-to-board connectors with a pitch of 1.27 mm, Phoenix Contact provides data rates up to 28 Gbps and customer-specific simulations for data integrity.

Further information on the
FR 1,27 series:

 Web code: [#1520](#)

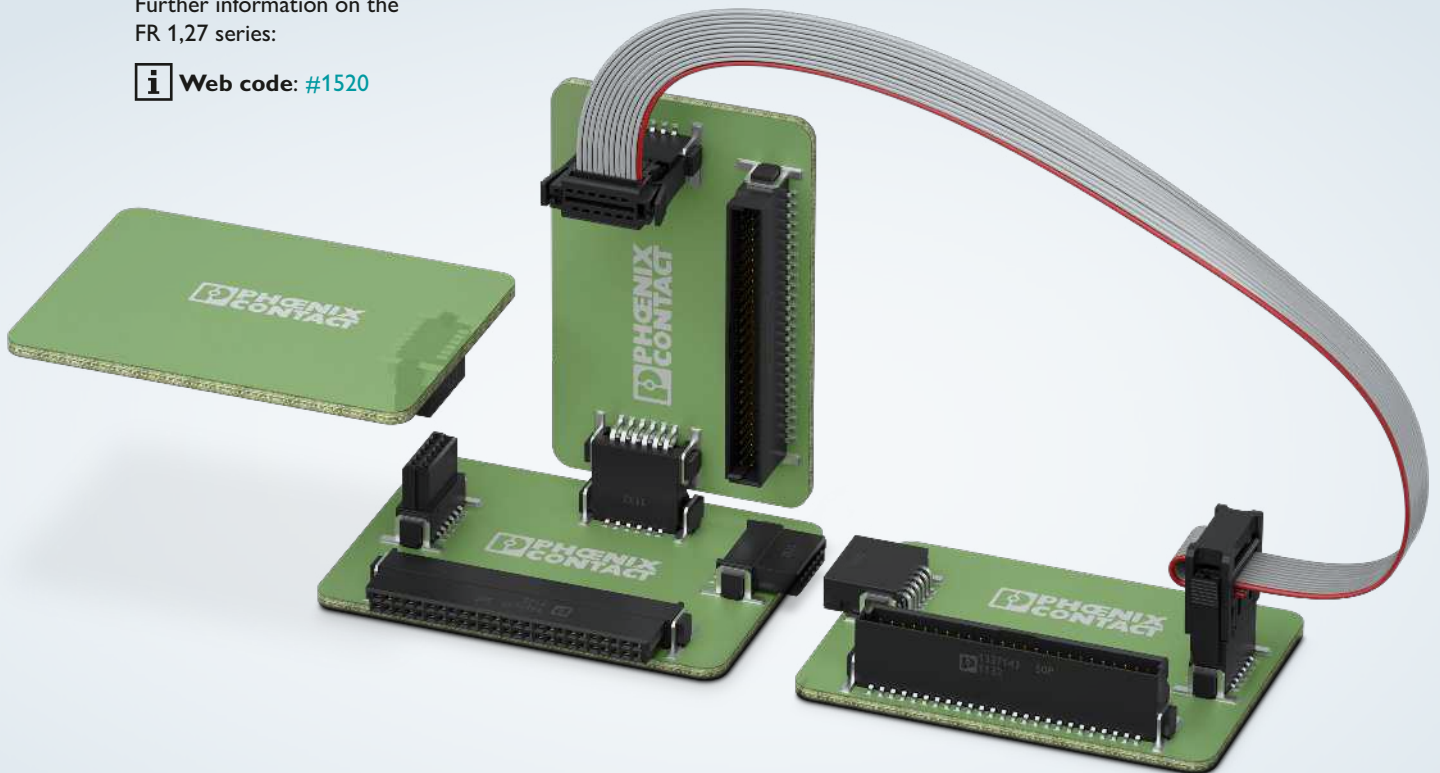

FR 1,27 series – advantages at a glance

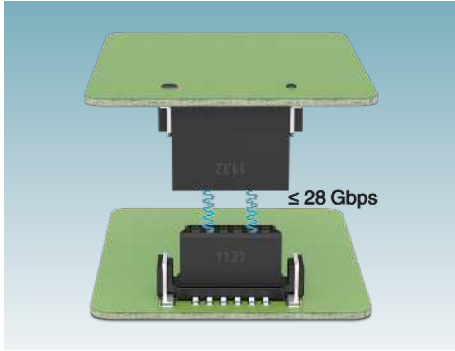

High-speed data

The first high-speed data transmission at up to 28 Gbps in the established market standard offers new design possibilities.

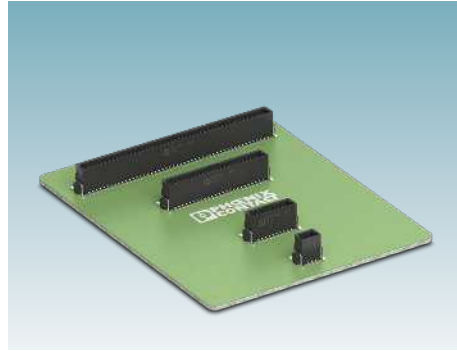

Diversity

Robust 6-pos. to 100-pos. board-to-board and wire-to-board connectors provide greater flexibility in component options.

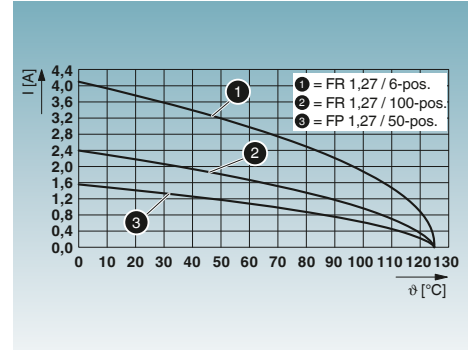

Quality in detail

Gold-plated contact points enable long-term stable signal transmission and currents up to 2.3 A.



Simulation service

Time-savings during the development process with customer-specific simulations for data integrity.

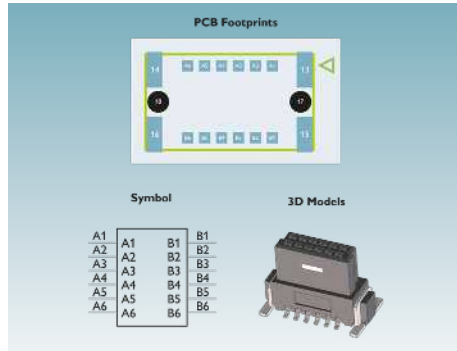

Design-in support

Benefit from the comprehensive service and support with MCAD and ECAD data as well as our sample service.

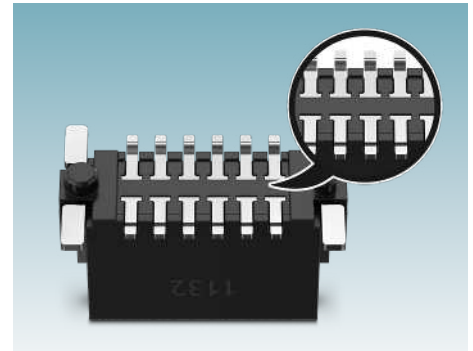

Processed reliably

Positioning pins on the underside and a coplanarity of ≤ 0.1 mm ensure secure positioning and subsequent soldering on the PCB.

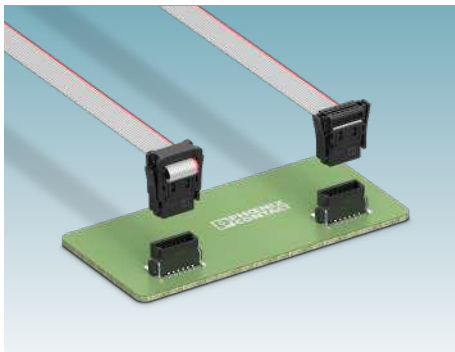

Vibration-resistant male connector

Latching on both sides of the IDC connector prevents connections from coming loose due to vibrations – optionally available with strain relief.

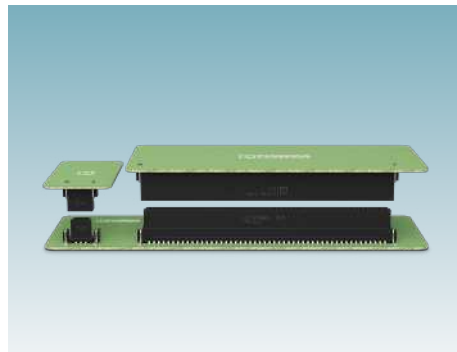

Flexible device design

Eleven different numbers of positions and stack heights from 8 to 13.8 mm enable a great deal of freedom for the device design.

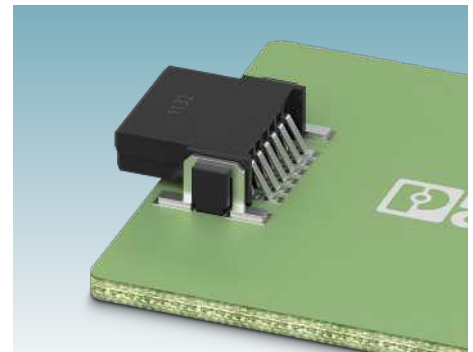

Stable and robust

Stable signal contacts and armature metals enable a robust PCB connection designed for a maximum of 500 plug and unplug cycles.

FR 1,27 series – installation instructions

Stack heights

The stack height describes the clearance between two PCBs overlapping in parallel (mezzanine arrangement). You can use vertical versions of the female and male connector strips to reliably connect PCBs. With their wipe length of 1.5 mm, the PCB connectors are ideal for a continuous range of stack heights between 8 and 13.8 mm. We plan to extend the portfolio in the future to include stack heights up to 20 mm.

Stack height	Male connector strip	Female connector strip
8.0 mm ... 9.5 mm	FR 1,27/...-MV 1,75	FR 1,27/...-FV 6,25
9.5 mm ... 11.0 mm	FR 1,27/...-MV 3,25	FR 1,27/...-FV 6,25
10.8 mm ... 12.3 mm	FR 1,27/...-MV 1,75	FR 1,27/...-FV 9,05
12.3 mm ... 13.8 mm	FR 1,27/...-MV 3,25	FR 1,27/...-FV 9,05

The female connector strip is fully inserted into the male connector strip with the respective minimum PCB spacing. To achieve the maximum PCB spacing, 1.5 mm of the male contact remains outside the contact zone. At the same time, a reliable contact overlap of at least 0.9 mm is ensured at all times.

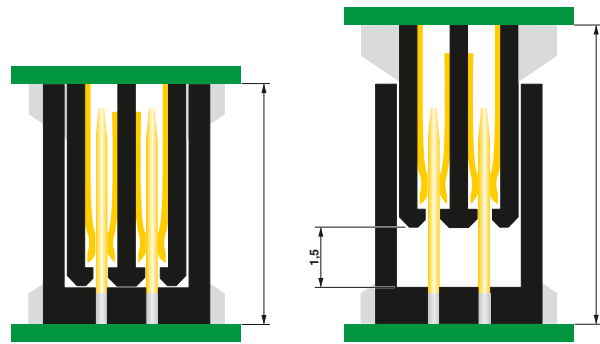

Minimum PCB spacing (left) and maximum PCB spacing (right) due to the wipe length

Tolerance compensation

During the plugging process, the connectors have a position tolerance of ± 0.7 mm in the longitudinal and transverse directions. The geometry also enables an inclination tolerance of $\pm 5^\circ$ when connecting. These flexible tolerance compensations enable a flexible design of the PCB arrangement.

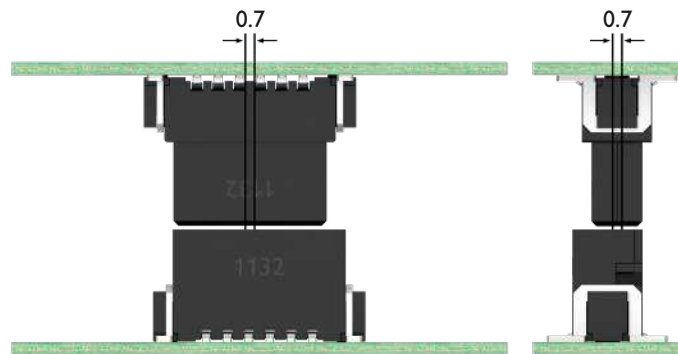

Center offset when plugging in

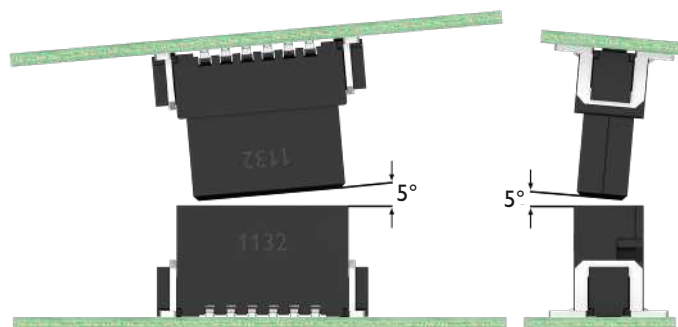

Inclination tolerance when connecting

Variance

The board-to-board connectors of the FR 1,27 series are also available in customer-specific variants on request, in addition to the standard items listed in the product overview. For example, partial assemblies are possible for the angled and straight male and female connector strips that may be required in some applications, for example, to increase the air clearances and creepage distances.

Hot-swapping capability with the last make, first break contacts. Last make, first break contacts are realized by pins in the male connector strips, which are 0.4 mm shorter. This ensures that a defined sequence of ground and signal contacts is maintained during plugging and unplugging, making a changeover possible when operating with first make, last break reference potential equalization. With the generous contact overlap of a total of 2.4 mm (1.5 mm wiping + 0.9 mm contact reliability), reliable contacting is ensured even for last make, first break contacts, i.e., contacts that are 0.4 mm shorter.

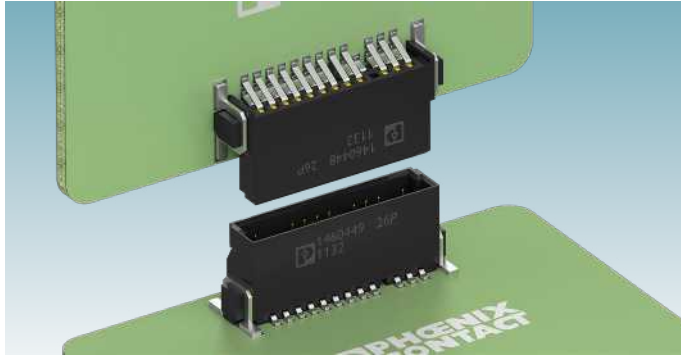

Example of an orthogonal board-to-board connection with partially assembled and shorter contacts

Improved item properties

At the end of 2018, Phoenix Contact officially launched the FP 1,27 series and entered the market of board-to-board connectors. The new FR 1,27 series surpasses the properties of the past products in many respects, allowing its use in numerous other applications.

The adjacent diagram compares the current transmission behavior of FP 1,27 and FR 1,27 as an example. Depending on the number of positions, a current of up to 3.7 A per contact is possible with FR 1,27 (current carrying capacity test with full current of a 6-pos. board-to-board connection). For FP 1,27, a nominal current of 1.4 A was approved for all versions. Optimizing the contact geometries and using high-performance materials made this possible. The nominal current for FR 1,27 is 2.3 A per contact.

In addition, the new FR 1,27 product line is suitable for high-speed data transmission of up to 28 Gbps (see next page). This sets it far part from the other commercially

available solutions from other manufacturers on the market.

They are fully compatible with equivalent products offered by relevant market competitors. Corresponding test reports are available on request.

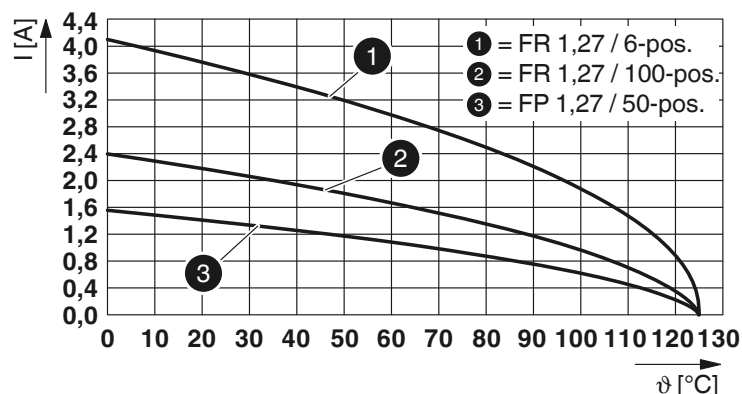

Derating diagram showing a comparison of the largest and smallest number of positions for FR 1,27 and the nominal current curve of the predecessor FP 1,27 (50-pos.)

FR 1,27 series – data transmission properties

High-speed data transmission

The new FR 1,27 series is ideally suited for high-speed data transmissions up to 28 Gbps. Excellent signal integrity is achieved even at high frequencies up to 14 GHz. The following diagrams illustrate the data transmission properties of the smallest and largest possible stack height in assignments with differential pairs and ground pins in the following order per contact row: G, S, S, G, S, S, G. Further diagrams as well as S-parameters for own simulations are available on request.

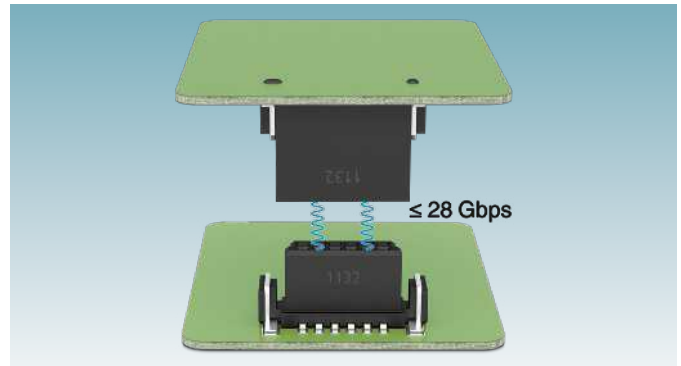

Insertion loss

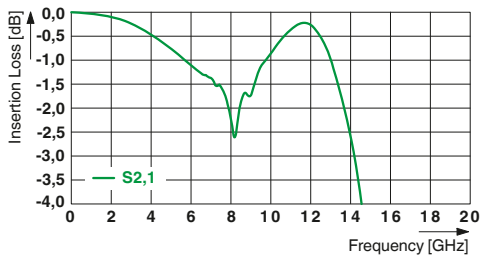

FR 1,27/...-FV 6,25 with FR 1,27/...-MV 1,75, differential pair, 8.0 mm stack height



FR 1,27/...-FV 9,05 with FR 1,27/...-MV 3,25, differential pair, 13.8 mm stack height

Crosstalk

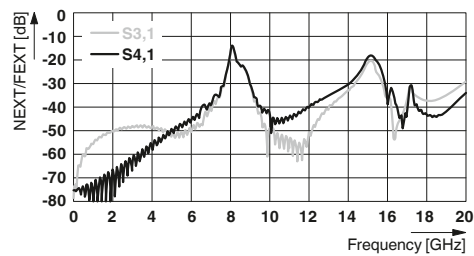

FR 1,27/...-FV 6,25 with FR 1,27/...-MV 1,75, differential pair, 8.0 mm stack height

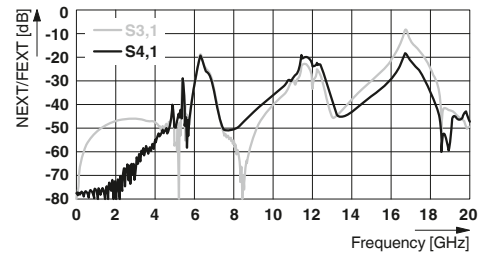

FR 1,27/...-FV 9,05 with FR 1,27/...-MV 3,25, differential pair, 13.8 mm stack height

Impedance

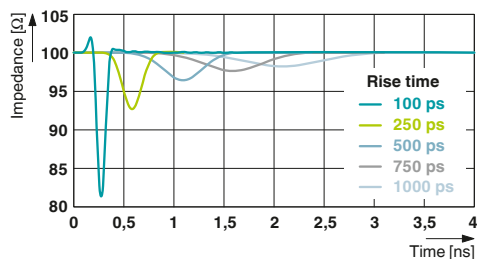

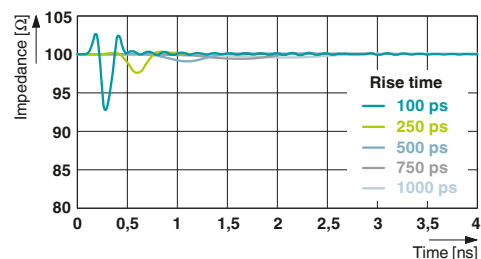

FR 1,27/...-FV 6,25 with FR 1,27/...-MV 1,75, differential pair, 8.0 mm stack height



FR 1,27/...-FV 9,05 with FR 1,27/...-MV 3,25, differential pair, 13.8 mm stack height

FR 1,27 series – technical data

General technical data		Standards/note
Pitch	1.27 mm	
Number of positions board-to-board	6, 12, 16, 20, 26, 32, 40, 50, 68, 80, 100	
Number of positions wire-to-board	12, 16, 20, 26, 32, 40, 50, 68, 80	
Data transmission speed	Up to 28 Gbps	
Nominal current at full current, 50-pos. (at 20°C)	2.3 A (50-pos.)	IEC 60512-5-2:2002
Insulation resistance	Min. 10 GΩ	IEC 60512-3-1:2002
Contact resistance	Max. 25 mΩ	IEC 60512-2-1:2002
Test voltage	500 V AC	IEC 60512-4-1:2003
Rated voltage (I/1)	160 V	IEC 60664-1:2020
Rated surge voltage (I/1)	0.8 kV	IEC 60664-1:2020
Air clearances and creepage distances	Min. 0.4 mm	
Temperature limits during operation	-55°C to +125°C	
Insertion and withdrawal force per contact	Approx. 0.5 N	
Approval	UL 1977 / CSA C22.2 No 182-3 In preparation	
Environmental and durability tests		
Service life	500 insertion cycles, performance level I	IEC 60512-9-1:2010
Oscillation, sinusoidal	10 ... 2000 Hz, 20g	IEC 60512-6-4:2002
Contact interference during oscillation, sinusoidal	<1 μs	IEC 60512-2-5:2003
Shocks, half-sinusoidal	50g, 11 ms	IEC 60512-6-3:2002
Contact interference during shocks, half-sinusoidal	<1 μs	IEC 60512-2-5:2003
Information on metal parts		
Note	WEEE/RoHS-compliant, free of whiskers	IEC 60068-2-82/JEDEC JESD 201
Live metal parts	Cu alloy	
Surface of contact area	Ni, Au	
Surface of soldering area	Sn	
Information on insulation material		
Insulation material and group	LCP, IIIb	
Resistance to creepage	CTI 150	DIN EN 60112 (VDE 0303-11)
Flammability rating in accordance with UL 94	V0	
Processing note		
Process	SMD soldering	Based on IPC/JEDEC J-STD-020D.1:2008-03
Moisture sensitivity level	MSL 1	
Coplanarity	≤0.1 mm	
Connection capacity of IDC female connector strip		
Pitch of flat-ribbon cable	0.635 mm	
Standard cable type	PVC	
Conductor cross-section AWG/kcmil	30/7	
Contact resistance of IDC female connector strip	Max. 10 mΩ	

Vertical female connector strip					
Number of positions	Installed height: 6.25 mm		Installed height: 9.05 mm		
	Type	Item no.	Type	Item no.	
	6	FR 1,27/ 6-FV 6,25	1374026	FR 1,27/ 6-FV 9,05	1374872
	12	FR 1,27/ 12-FV 6,25	1374027	FR 1,27/ 12-FV 9,05	1374873
	16	FR 1,27/ 16-FV 6,25	1374028	FR 1,27/ 16-FV 9,05	1374874
	20	FR 1,27/ 20-FV 6,25	1374029	FR 1,27/ 20-FV 9,05	1374875
	26	FR 1,27/ 26-FV 6,25	1374030	FR 1,27/ 26-FV 9,05	1374877
	32	FR 1,27/ 32-FV 6,25	1374031	FR 1,27/ 32-FV 9,05	1374879
	40	FR 1,27/ 40-FV 6,25	1374032	FR 1,27/ 40-FV 9,05	1374880
	50	FR 1,27/ 50-FV 6,25	1374033	FR 1,27/ 50-FV 9,05	1374881
	68	FR 1,27/ 68-FV 6,25	1374034	FR 1,27/ 68-FV 9,05	1374882
	80	FR 1,27/ 80-FV 6,25	1374036	FR 1,27/ 80-FV 9,05	1374883
	100	FR 1,27/100-FV 6,25	1374037	FR 1,27/100-FV 9,05	1374884
	Horizontal female connector strip				
	Number of positions	Type	Item no.		
		6	FR 1,27/ 6-FH	1337009	
12		FR 1,27/ 12-FH	1337010		
16		FR 1,27/ 16-FH	1337011		
20		FR 1,27/ 20-FH	1337012		
26		FR 1,27/ 26-FH	1337013		
32		FR 1,27/ 32-FH	1337014		
40		FR 1,27/ 40-FH	1337015		
50		FR 1,27/ 50-FH	1337018		
68		FR 1,27/ 68-FH	1337019		
80		FR 1,27/ 80-FH	1337020		
100		FR 1,27/ 100-FH	1337021		

		Vertical male connector strip				
Number of positions	Base height 1.75 mm		Base height 3.25 mm			
	Type	Item no.	Type	Item no.		
	6	FR 1,27/ 6-MV 1,75	1373826	FR 1,27/ 6-MV 3,25	1337137	
	12	FR 1,27/ 12-MV 1,75	1373827	FR 1,27/ 12-MV 3,25	1337138	
	16	FR 1,27/ 16-MV 1,75	1373828	FR 1,27/ 16-MV 3,25	1337139	
	20	FR 1,27/ 20-MV 1,75	1373866	FR 1,27/ 20-MV 3,25	1337140	
	26	FR 1,27/ 26-MV 1,75	1373883	FR 1,27/ 26-MV 3,25	1337141	
	32	FR 1,27/ 32-MV 1,75	1373886	FR 1,27/ 32-MV 3,25	1337147	
	40	FR 1,27/ 40-MV 1,75	1373887	FR 1,27/ 40-MV 3,25	1337142	
	50	FR 1,27/ 50-MV 1,75	1373889	FR 1,27/ 50-MV 3,25	1337143	
	68	FR 1,27/ 68-MV 1,75	1373892	FR 1,27/ 68-MV 3,25	1337144	
	80	FR 1,27/ 80-MV 1,75	1373894	FR 1,27/ 80-MV 3,25	1337145	
	100	FR 1,27/100-MV 1,75	1373896	FR 1,27/100-MV 3,25	1337146	
			Horizontal male connector strip			
	Number of positions	Type	Item no.	<p>High degree of flexibility</p> <p>If the number of positions matches, any male connector strip can be combined with any female connector strip. The high-position PCB connectors with 1.27 mm pitch are compatible with the layouts and connections of existing systems on the market. Corresponding compatibility reports are available on request.</p>		
6	FR 1,27/ 6-MH	1377295				
12	FR 1,27/ 12-MH	1377297				
16	FR 1,27/ 16-MH	1377298				
20	FR 1,27/ 20-MH	1377299				
26	FR 1,27/ 26-MH	1377300				
32	FR 1,27/ 32-MH	1377301				
40	FR 1,27/ 40-MH	1377302				
50	FR 1,27/ 50-MH	1377303				
68	FR 1,27/ 68-MH	1377304				
80	FR 1,27/ 80-MH	1377305				
100	FR 1,27/100-MH	1377306				

Number of positions

The double-row board-to-board connectors are available with the following number of positions: 6, 12, 16, 20, 26, 32, 40, 50, 68, 80, and 100. Other numbers of positions between 6 and 100-pos., in increments of 2, are also available on request. The number of positions corresponds to the total number of contacts.

Example: A 12-position item has six contacts per row. On all FP 1,27 series products, position 1 is marked as a1.

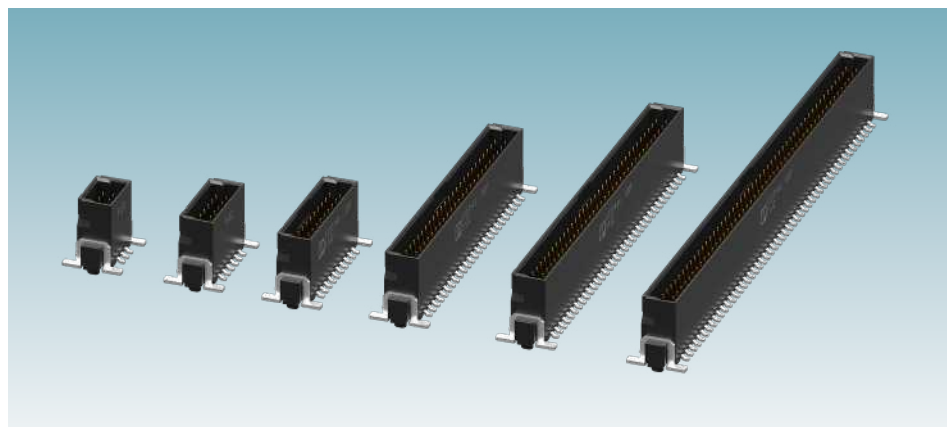

Various numbers of positions from 6 to 100

FR 1,27 series – assembled IDC female connector strip

Configurator for FR 1,27 cable assembly

Design your own unique module with the help of our configurator. It offers a simple, graphically supported method for creating individual cable assemblies. Select the number of positions and the cable length, determine the orientation of the connectors, and add an optional strain relief. Our configurator gives you the capability to create exactly the cable assembly that meets your own requirements.

During the configuration process, you can adapt the following product features to your own requirements.

1. The desired number of positions
2. The desired cable length
3. The flat-ribbon cable material
4. The number of IDC female connector strips used
5. The orientation of the IDC female connector strips on the flat-ribbon cable
6. The attachment of an optional strain relief

The quotation and ordering process

Have you created your own customized configuration? Once your configuration is completed, you will receive your personal solution ID, which is assigned to your configuration. To access an existing configuration in the configurator again or place an order at any time, simply enter the solution ID.

Easy-to-order sample items

With a minimum order quantity of ten pieces, sample items are available for each number of positions. They include a firmly attached cable assembly with two female connector strips in identical orientation. The sample items are delivered with a PVC flat-ribbon cable with a length of 0.1 m. The optional strain relief is available separately via the Sample Service on the Phoenix Contact homepage.

Strain relief for IDC female connector strips

The IDC female connectors strips of the FR 1,27 series can be fitted with an optional strain relief. It attaches the flat-ribbon cable to the housing of the connector, thereby protecting the IDC contact inside the connector from excessive mechanical stress. Mounting strain relief can increase the service life of the connector in the event of mechanical stress, for example, due to vibration. If necessary, the strain relief can be removed.

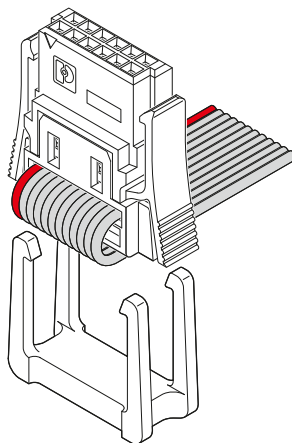

The strain relief is mounted tool-free by snapping it onto the IDC female connector strip.

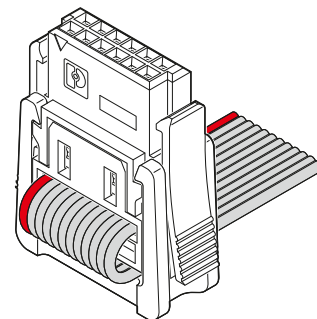

The strain relief firmly attaches the flat-ribbon cable to the connector.

IDC female connector strip		
Number of positions	Type	Item no.
12	FR 1,27/ 12-FWL	1378542
16	FR 1,27/ 16-FWL	1378544
20	FR 1,27/ 20-FWL	1378546
26	FR 1,27/ 26-FWL	1378548
32	FR 1,27/ 32-FWL	1378549
40	FR 1,27/ 40-FWL	1378550
50	FR 1,27/ 50-FWL	1378551
68	FR 1,27/ 68-FWL	1378553
80	FR 1,27/ 80-FWL	1378554



Sample items		
Number of positions	Type	Item no.
12	SAMPLE FR 1,27/ 12-FWL-11/ P/ 0,1	1508260
16	SAMPLE FR 1,27/ 16-FWL-11/ P/ 0,1	1508261
20	SAMPLE FR 1,27/ 20-FWL-11/ P/ 0,1	1508262
26	SAMPLE FR 1,27/ 26-FWL-11/ P/ 0,1	1508265
32	SAMPLE FR 1,27/ 32-FWL-11/ P/ 0,1	1508267
40	SAMPLE FR 1,27/ 40-FWL-11/ P/ 0,1	1508269
50	SAMPLE FR 1,27/ 50-FWL-11/ P/ 0,1	1508270
68	SAMPLE FR 1,27/ 68-FWL-11/ P/ 0,1	1508272
80	SAMPLE FR 1,27/ 80-FWL-11/ P/ 0,1	1508273



Strain relief		
Number of positions	Type	Item no.
12	FR 1,27/ 12-SR	1399640
16	FR 1,27/ 16-SR	1399641
20	FR 1,27/ 20-SR	1399642
26	FR 1,27/ 26-SR	1399643
32	FR 1,27/ 32-SR	1399645
40	FR 1,27/ 40-SR	1399646
50	FR 1,27/ 50-SR	1399647
68	FR 1,27/ 68-SR	1399648
80	FR 1,27/ 80-SR	1399649



Universal pin headers and sockets with 1.27 and 2.54 mm pitch

FQ series board-to-board connectors can be used universally. They are characterized by their application-oriented and cost-optimized design. The pin headers and sockets with 1.27 and 2.54 mm pitch enable mezzanine, coplanar, and mother-daughter connections to be implemented.

Further information on the FQ
1,27 and FQ 2,54 series:

 **Web code:** [#2880](#)

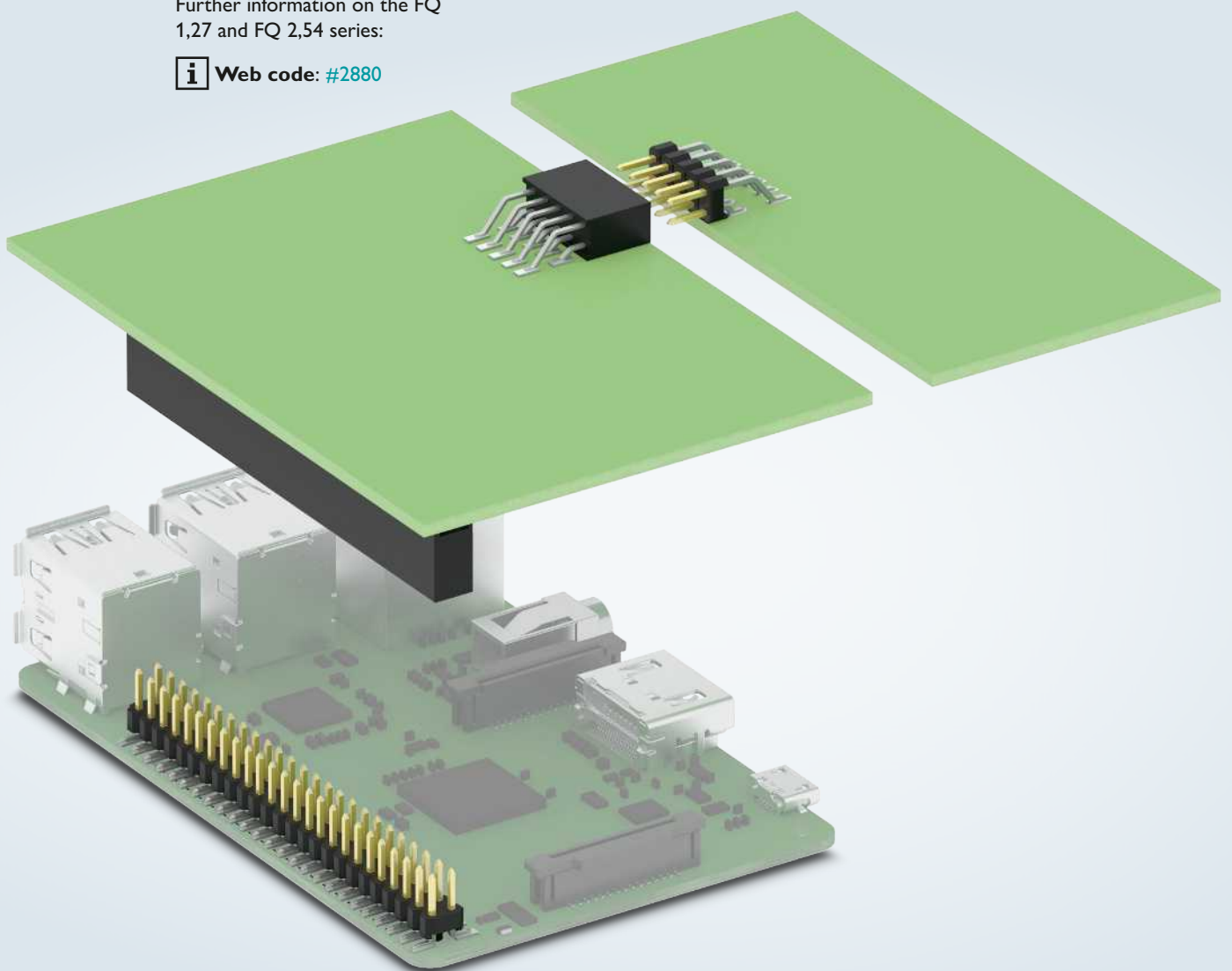

FQ 1,27/FQ 2,54 series – technical data

General technical data	FQ 1,27	FQ 2,54	Standards/note
Pitch	1.27 mm	2.54 mm	
Pin diameter	0.40 mm	0.64 mm	
Number of positions	10, 20, 30, 50, 80	10, 20, 30, 50, 80	
Nominal current, 80-pos. (at 20°C)	1 A (per contact)	3 A (per contact)	IEC 60512-5-2:2002
Insulation resistance	Min. 1 GΩ	Min. 1 GΩ	IEC 60512-3-1:2002
Contact resistance	Max. 30 mΩ	Max. 30 mΩ	IEC 60512-2-1:2002
Test voltage	500 V AC	500 V AC	IEC 60512-4-1:2003
Rated voltage (I/I)	125 V	160 V	IEC 60664-1:2020
Rated surge voltage (I/I)	0.8 kV	0.8 kV	IEC 60664-1:2020
Air clearances and creepage distances	Min. 0.25 mm	Min. 0.40 mm	
Temperature limits during operation	-40°C to +125°C	-40°C to +125°C	
Insertion and withdrawal force per contact	≤1.2 N	≤2.9 N	
Approval	UL 1977 / CSA C22.2 No 182-3	UL 1977 / CSA C22.2 No 182-3	
Environmental and durability tests			
Service life	100 insertion cycles	100 insertion cycles	IEC 60512-9-1:2010
Oscillation, sinusoidal	10 ... 55 Hz, 18g	10 ... 55 Hz, 18g	IEC 60512-6-4:2002
Contact interference during oscillation, sinusoidal	≤1 μs	≤1 μs	IEC 60512-2-5:2003
Information on metal parts			
Note	WEEE/RoHS-compliant	WEEE/RoHS-compliant	
Live metal parts	Cu alloy	Cu alloy	
Surface of contact area	Ni, Au	Ni, Au	
Surface of soldering area	Sn	Sn	
Information on insulation material			
Insulation material and group	PA, I	PA, I	
Color	Black	Black	
Resistance to creepage	CTI ≥600	CTI ≥600	DIN EN 60112 (VDE 0303-11)
Flammability rating in accordance with UL 94	V0	V0	
Processing note			
Process	SMD soldering	SMD soldering	Based on IPC/JEDEC J-STD-020E:2014-12
Moisture sensitivity level	MSL 1	MSL 1	
Coplanarity	≤0.1 mm	Max. ≤0.15 mm (depending on the number of positions)	
Packaging	Tape-on-reel	Tube magazine	

FQ 1,27/FQ 2,54 series – installation instructions

High degree of flexibility

Various pitches, numbers of positions, and designs allow a great deal of freedom for the device design. Due to the flexible wipe length range of 1.3 mm, you can realize stack heights from 6.2 to 7.5 mm (FQ 1,27) or 13.6 to 14.9 mm (FQ 2,54). We plan to extend the portfolio in the future to include additional stack heights. Alternative pin lengths of the pin strips are available on request.

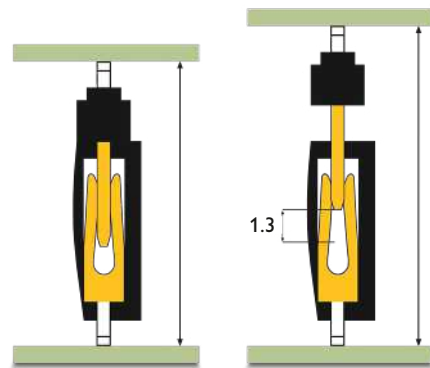

Automated processability

The connectors of the FQ 1,27 series are supplied in tape-on-reel packaging, while the items of the FQ 2,54 series are packaged in a box magazine. All items have suitable suction surfaces and additional pick-and-place pads. Alternative packaging types are available on request.

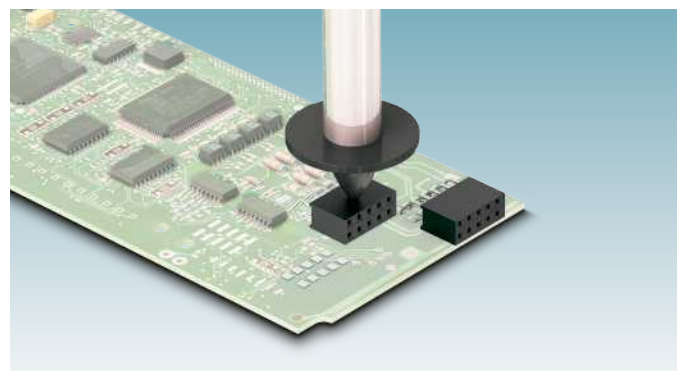

Securely positioned

Positioning pins on the bottom ensure secure positioning on the PCB. Versions with and without positioning pins are available on request.

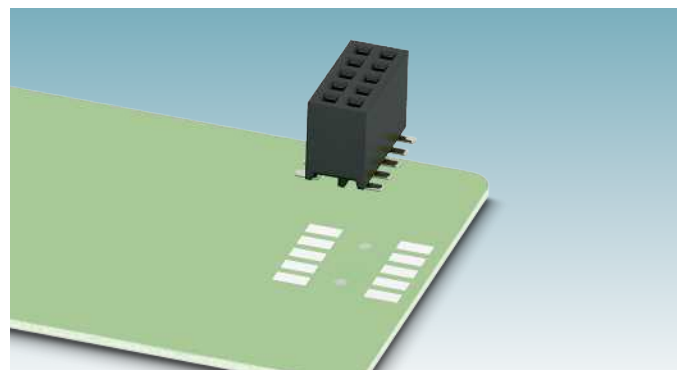





Automatic quality control

The PCB connectors are soldered using the SMT method. The soldering contacts are routed under the housing, enabling automatic optical inspection (AOI).



FQ 1,27				
	Vertical pin strip		Vertical base strip	
				
Number of positions	Type	Item no.	Type	Item no.
10	FQ 1,27D/ 10-PV- 160-1-BR	1156861	FQ 1,27D/ 10-SV- 490-1-BR	1156833
20	FQ 1,27D/ 20-PV- 160-1-BR	1156862	FQ 1,27D/ 20-SV- 490-1-BR	1156835
30	FQ 1,27D/ 30-PV- 160-1-BR	1156863	FQ 1,27D/ 30-SV- 490-1-BR	1156838
50	FQ 1,27D/ 50-PV- 160-1-BR	1156864	FQ 1,27D/ 50-SV- 490-1-BR	1156839
80	FQ 1,27D/ 80-PV- 160-1-BR	1156865	FQ 1,27D/ 80-SV- 490-1-BR	1156842

FQ 2,54				
	Vertical pin strip		Vertical base strip	
				
Number of positions	Type	Item no.	Type	Item no.
10	FQ 2,54D/ 10-PV- 380-1-BT	1156914	FQ 2,54D/ 10-SV-1020-1-BT	1156886
20	FQ 2,54D/ 20-PV- 380-1-BT	1156915	FQ 2,54D/ 20-SV-1020-1-BT	1156888
30	FQ 2,54D/ 30-PV- 380-1-BT	1156917	FQ 2,54D/ 30-SV-1020-1-BT	1156889
50	FQ 2,54D/ 50-PV- 380-1-BT	1156918	FQ 2,54D/ 50-SV-1020-1-BT	1156891
80	FQ 2,54D/ 80-PV- 380-1-BT	1156921	FQ 2,54D/ 80-SV-1020-1-BT	1156893
	Horizontal pin strip		Horizontal base strip	
				
Number of positions	Type	Item no.	Type	Item no.
10	FQ 2,54D/ 10-PH-1-BT	1156939	FQ 2,54D/ 10-SH-0-BT	1156901
20	FQ 2,54D/ 20-PH-1-BT	1156942	FQ 2,54D/ 20-SH-0-BT	1156904
30	FQ 2,54D/ 30-PH-1-BT	1156943	FQ 2,54D/ 30-SH-0-BT	1156905
50	FQ 2,54D/ 50-PH-1-BT	1156944	FQ 2,54D/ 50-SH-0-BT	1156906
80	FQ 2,54D/ 80-PH-1-BT	1156945	FQ 2,54D/ 80-SH-0-BT	1156907

Implement additional PCB connections with the COMBICON portfolio

In addition to FINEPITCH series board-to-board connectors, the extensive COMBICON product portfolio also offers numerous connectors for implementing PCB connections: from special connectors for flexible LED PCBs to connectors with 15 mm pitch for currents up to 125 A (IEC) per contact.

i Web code: #2053

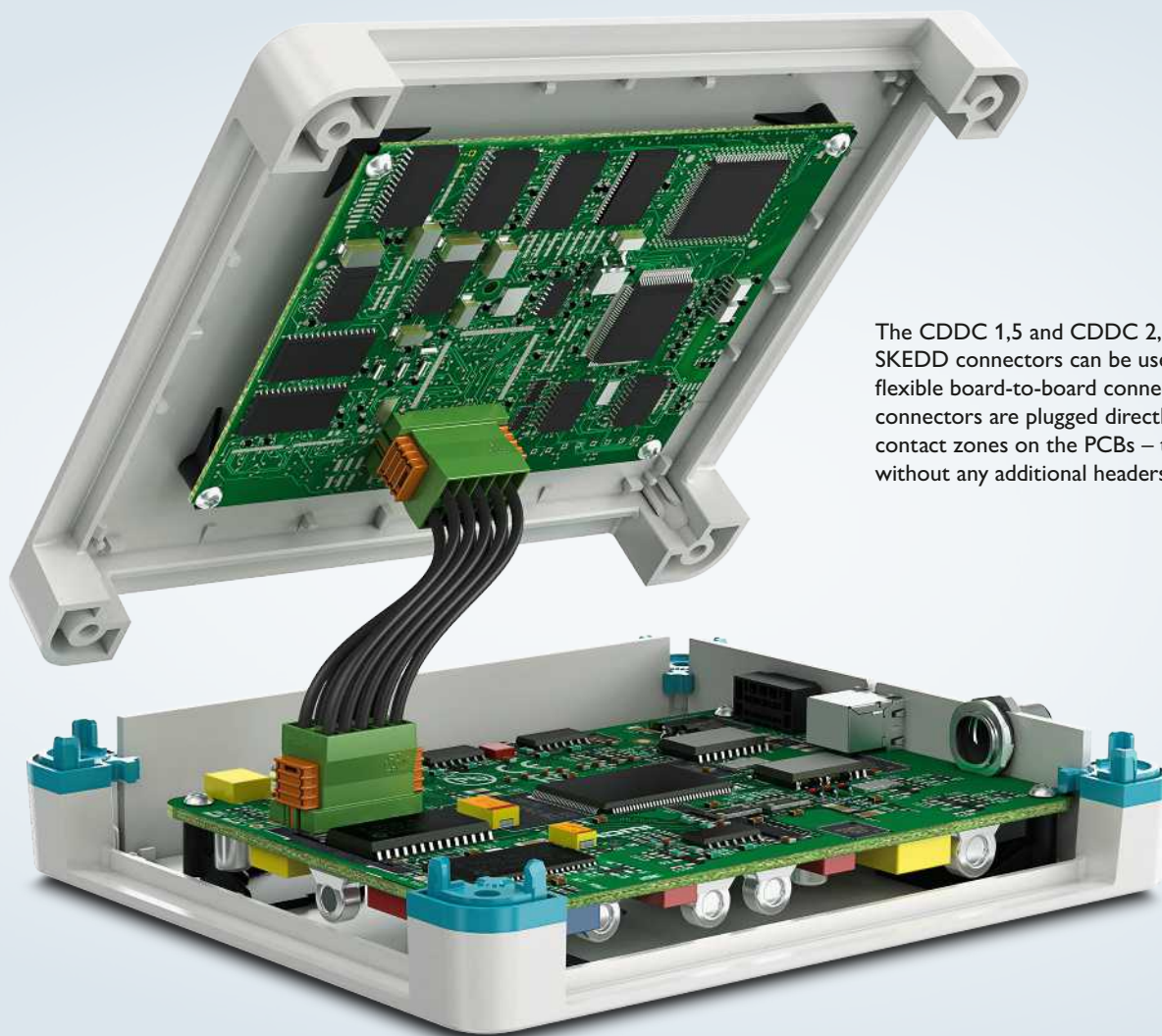

The CDDC 1,5 and CDDC 2,5 preassembled SKEDD connectors can be used to implement flexible board-to-board connections. The connectors are plugged directly into prepared contact zones on the PCBs – tool-free and without any additional headers.

Overview of the product series

 Web code: #0425

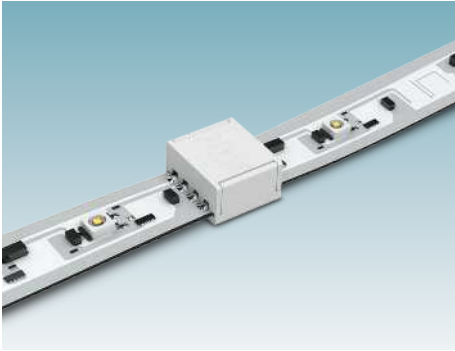

PTF 0,3

PCB connectors for direct plug-in for connecting flexible LED strips with a width of 8 or 10 mm.

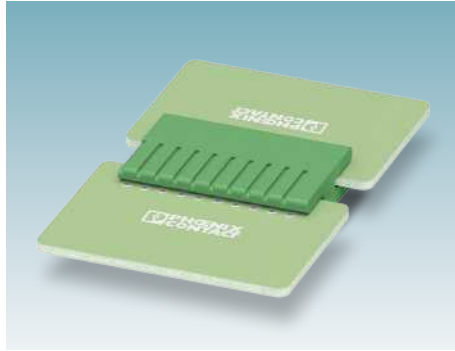

ZEC 1,0 / 1,5

PCB connectors for direct plug-in with 3.5, 5.0, and 7.5 mm pitch for currents up to 10 A per contact.

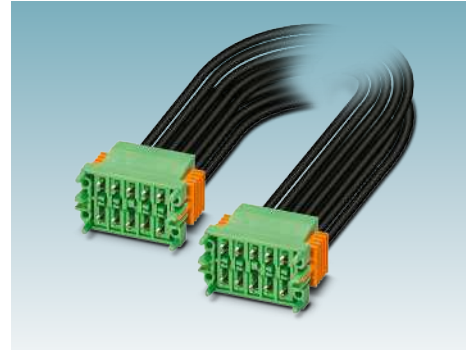

CDDC 1,5 / 2,5

Pre-assembled PCB connectors for direct plug-in with pitches of 3.5 mm and 5.0 mm currents of up to 12 A per contact.

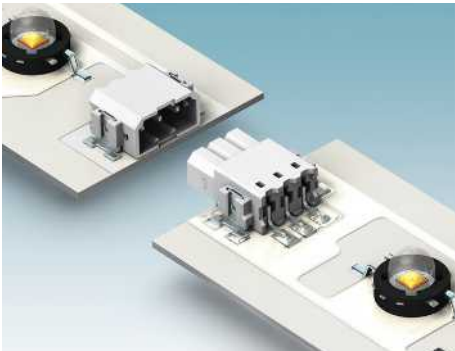

PTSM 0,5

THR and SMD PCB connectors with 2.5 mm pitch for currents up to 6 A per contact.

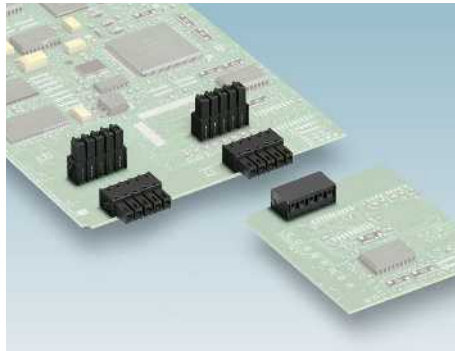

MC 1,5

PCB connectors with 3.5 and 3.81 mm pitch for currents up to 8 A per contact for THR and wave soldering.

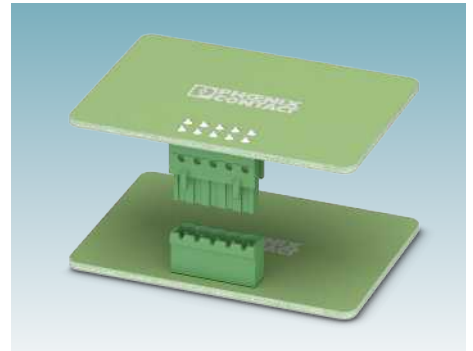

MSTB 2,5

PCB connectors with 5.08 and 7.62 mm pitch for currents up to 16 A per contact for wave soldering.

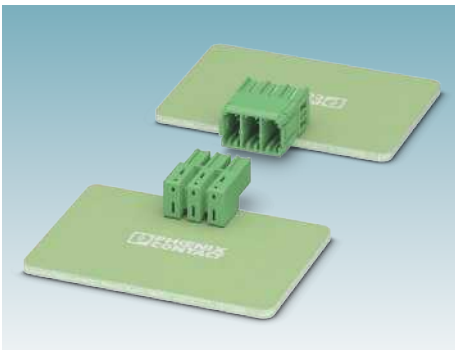

PC 5

PCB connectors with 7.62 mm pitch for currents up to 41 A per contact for wave soldering.

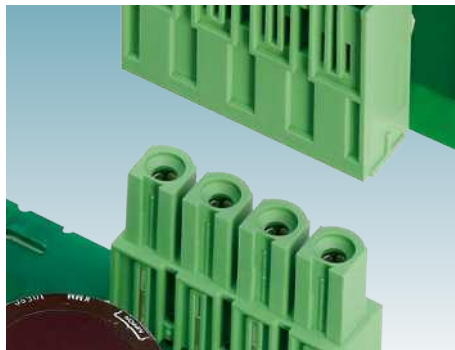

PC 16

PCB connectors with 10.16 mm pitch for currents up to 76 A per contact for wave soldering.

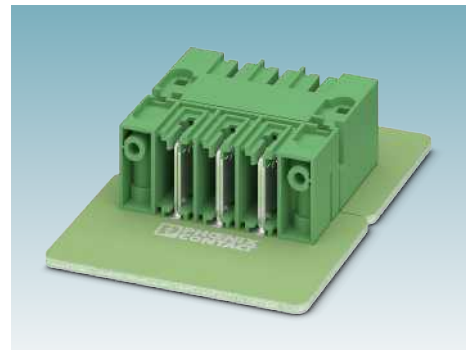

PC 35

PCB connectors with 15 mm pitch for currents up to 125 A per contact for wave soldering.

Overview of the product series

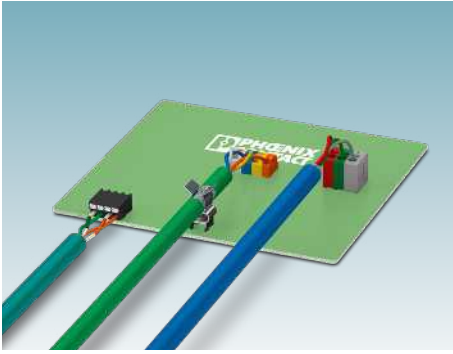

PCB terminal blocks

PCB terminals for data transmission offer ideal connection solutions for your application.

i Web code: [#2918](#)

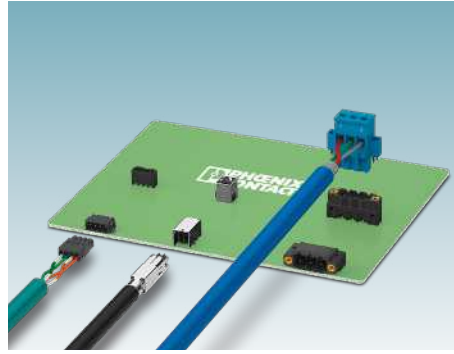

PCB connectors

PCB connectors for data transmission are available with innovative connection technologies and in numerous versions.

i Web code: [#2919](#)



M8 and M12 data connectors

Shielded circular connectors in sizes M8 and M12 for all common fieldbuses and networks.

i Web code: [#2913](#)



Connectors for SPE

ONEPAIR series IP20 PCB connectors and patch cables for Single Pair Ethernet.

i Web code: [#2671](#)

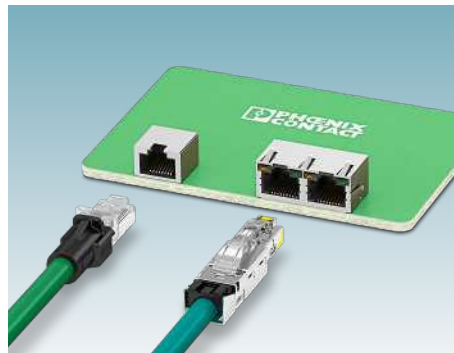

RJ45 connectors

Future-proof cabling solutions for building automation and Industrial Ethernet applications.

i Web code: [#2861](#)

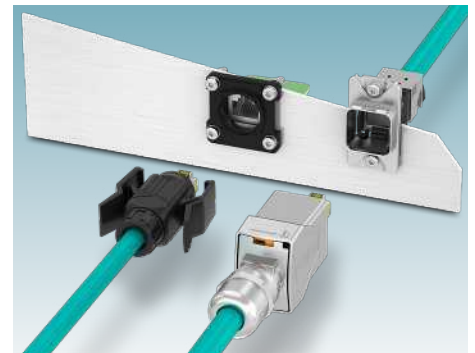

V6 and V14 connectors

Connectors of the V6 and V14 series are ideally suited for PROFINET and Ethernet cabling with the IP65/IP67 protection class.

i Web code: [#2922](#)



HDMI and USB connectors

The high-quality items from the HDMI and USB portfolio are ideal for reliable transmission.

i Web code: [#2924](#)



Coaxial connectors

The portfolio for coaxial cabling is ideal for the transmission of WLAN, Bluetooth, LTE, and 5G signals.

i Web code: [#2890](#)

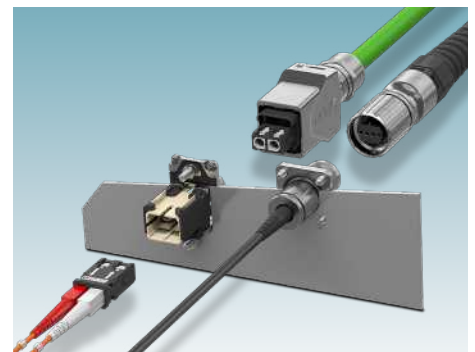

Fiber-optic based data connectors

Data transmission solutions with fiber-optic cables based on a comprehensive range of standardized connectors.

i Web code: [#2921](#)

Excellent services

Throughout your development process, Phoenix Contact will provide excellent services that make the difference. Discover how modern configurators, comprehensive technical data, and free product samples can make your daily work easier. As your partner, we will support you in the design-in process all the way to the development of customized connection and housing solutions.

The easy way to more choice

Choose online from 60,000 products and find the right solution quickly:

- Intuitive filter and search functions
- Comprehensive technical data and downloads such as drawings and 3D models
- Personal on-site consultation

The easy way to more individuality

Customize your products with colors, printing, and special designs:

- Customer-specific versions
- Customized new products
- Intuitive online configurators

The easy way to more flexibility

Use our different procurement channels and benefit from worldwide availability:

- All products can easily be ordered online
- Free online sample service
- Globally reliable logistics through direct shipping or distribution

The easy way to more expertise

Always stay up to date on technologies and trends with us as your reliable partner:

- Technology, industry, and design-in experts at your side
- We will provide you with custom training programs – either on site or digitally
- Free webinars, seminars, and video tutorials



Further information on Phoenix Contact services:
Simply enter the web code in the search field on our website.

 Web code: #2594



Simple selection using filters and technical data



There is a separate detail page for every product



A data sheet is available to download for every item



With our global network, Phoenix Contact is always nearby



Device connection technology can be comprehensively configured



Housing parts and connection technology are easy to configure



Cable and assembly systems can be matched easily



Phoenix Contact supports you from the initial idea right through to series production



Our online sample service is available in a large number of countries



Find the desired product quickly with intuitive filters



Product samples are available with free shipping



Reliable logistics worldwide



Keep up to date on new products, trends, and technologies



We will provide you with custom training programs – either on site or digitally



The latest information via the Phoenix Contact apps and YouTube channel



Remain reliably updated with the Phoenix Contact newsletter

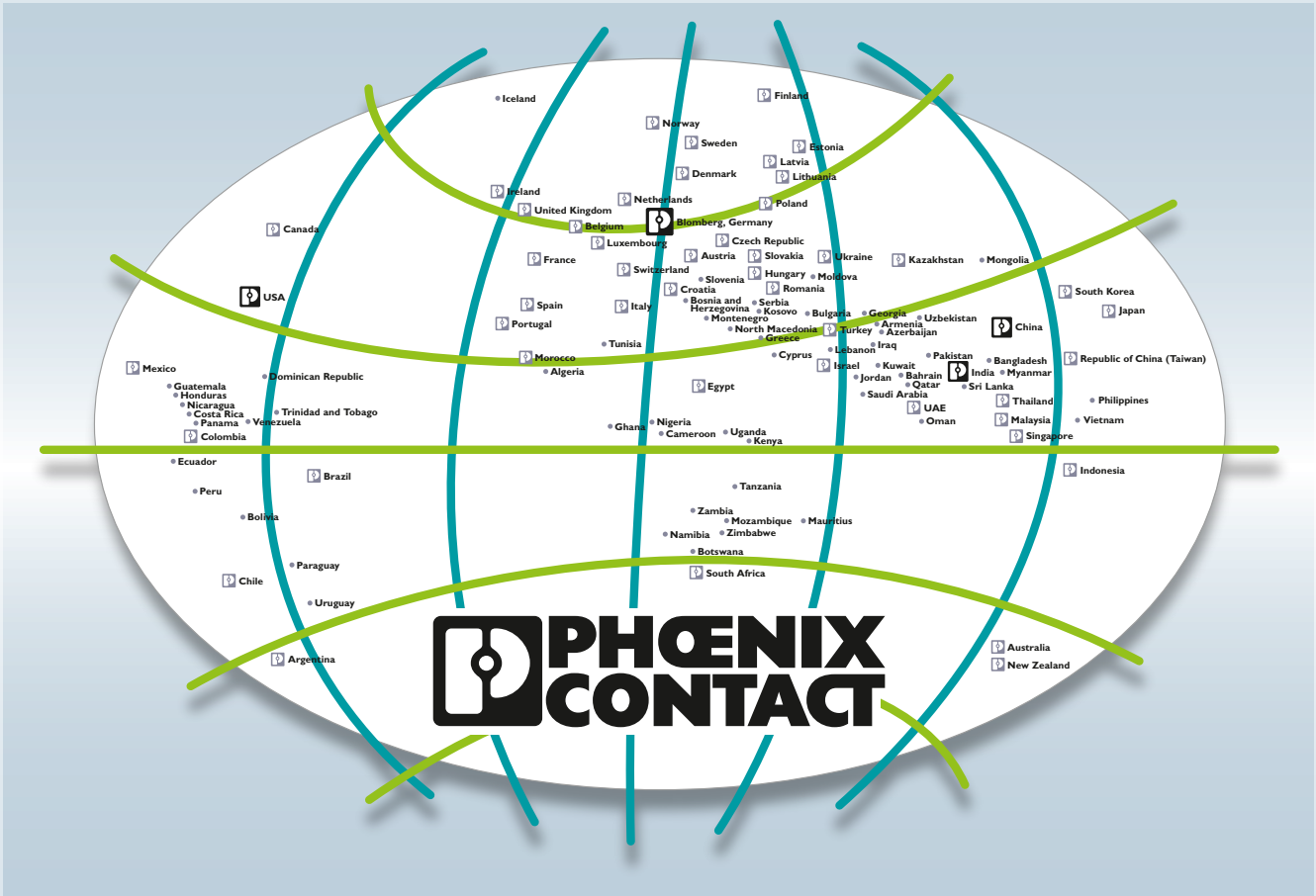

Open communication with customers and partners worldwide

Phoenix Contact is a global market leader based in Germany. We are known for producing future-oriented products and solutions for the electrification, networking, and automation of all sectors of the economy and infrastructure. With a global network reaching across more than 100 countries with over 22,000 employees, we maintain close relationships with our customers, something we believe is essential for our common success.

Our wide range of innovative products makes it easy for our customers to implement the latest technology in a variety of applications and industries. This especially applies to the target markets of energy, infrastructure, industry, and mobility.

You can find your local partner at

phoenixcontact.com