

Products Catalog

Plastic Film Capacitor

Electronic Equipment Use

AC Motor Use

Automotive, Industrial and Infrastructure Use

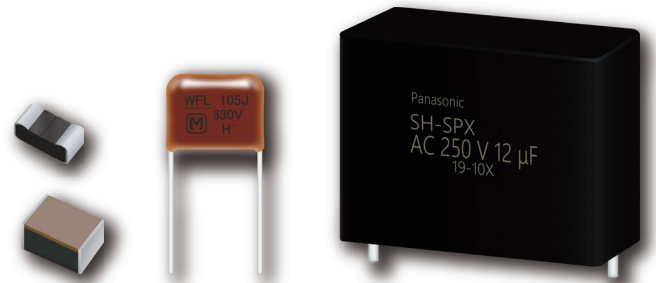

IN Your Future



Film Capacitor INDEX

Item		Page	
Precautions and warning		1	
Guidelines and precautions (Common / Chip type / Lead type)		2	
Summary of Products		16	
Series system diagram		18	
Main applications & Main products		19	
Permissible AC voltage corresponding to DC rated voltage		21	
Taping specification for automatic insertion (Mounting)		22	
Temperature & Frequency characteristics		25	
Product system for film chip capacitor		26	
Dielectric		Series	Page
Electronic equipment use	Stacked Metallized PPS Film Chip Capacitor	ECHU (X)	27
		ECHU (C)	29
	Stacked Metallized PEN Film Chip Capacitor	ECWU (X)	31
		ECWU (C)	33
		ECWU (V16)	36
	Stacked Metallized Plastic Film Chip Capacitor	ECPU (A) NRFND	38
	Metallized Polyester Film Capacitor	★ ECQE (F)	40
		ECQE (B)	50
		ECQE (T)	54
	Metallized Polypropylene Film Capacitor	ECWF (L)	60
		ECWF (A)	64
		ECWFD	68
		ECWFE	72
		ECWH (V)	75
		ECWH (A)	81
		ECWH (C)	84
		TMF	87
	Metallized Polypropylene Film Capacitor	ECQUA NRFND	88
		ECQUB NRFND	90
	AC motor use	Film Capacitor for AC Motor	DMF NRFND
PMF			95
SMF NRFND			97
Automotive, Industrial and infrastructure use	Metallized Polyester Film Capacitor for Noise Suppression of Automobile	ECQE	99
	Metallized Polypropylene Film Capacitor	ECWFG	100
	Metallized Polypropylene Film Capacitor	ECQUA (for car) NRFND	114
	DC-Link Film Capacitor	Type1 NRFND	120
	Metallized Polypropylene Film Capacitor	EZPE	123
		EZPE (Low profile type)	126
		★ EZPQ	128
	EZPV	145	

★Some part number have been designated Not Recommended for New Design.

NRFND Not recommended for new design

Safety and Legal Matters to Be Observed

Product specifications and applications

- Please be advised that this product and product specifications are subject to change without notice for improvement purposes. Therefore, please request and confirm the latest delivery specifications that explain the specifications in detail before the final design, or purchase or use of the product, regardless of the application. In addition, do not use this product in any way that deviates from the contents of the company's delivery specifications.
- Unless otherwise specified in this catalog or the delivery specifications, this product is intended for use in general electronic equipment (AV products, home appliances, commercial equipment, office equipment, information and communication equipment, etc.).
When this product is used for the following special cases, please separately discuss the delivery specifications suited to each application with the company. These include applications requiring special quality and reliability, wherein their failures or malfunctions may directly threaten human life or cause harm to the human body (e.g.: space/aircraft equipment, transportation/traffic equipment, combustion equipment, medical equipment, disaster prevention/crime prevention equipment, safety equipment, etc.).

Safety design and product evaluation

- Please ensure safety through protection circuits, redundant circuits, etc., in the customer's system design so that a defect in our company's product will not endanger human life or cause other serious damage.
- This catalog shows the quality and performance of individual parts. The durability of parts varies depending on the usage environment and conditions. Therefore, please ensure to evaluate and confirm the state of each part after it has been mounted in your product in the actual operating environment before use.
If you have any doubts about the safety of this product, then please notify us immediately, and be sure to conduct a technical review including the above protection circuits and redundant circuits at your company.

Laws / Regulations / Intellectual property

- The transportation of dangerous goods as designated by UN numbers, UN classifications, etc., does not apply to this product. In addition, when exporting products, product specifications, and technical information described in this catalog, please comply with the laws and regulations of the countries to which the products are exported, especially those concerning security export control.
- Each model of this product complies with the RoHS Directive (Restriction of the use of hazardous substances in electrical and electronic equipment) (2011/65/EU and (EU) 2015/863). The date of compliance with the RoHS Directive and REACH Regulation varies depending on the product model.
Further, if you are using product models in stock and are not sure whether or not they comply with the RoHS Directive or REACH Regulation, please contact us by selecting "Sales Inquiry" from the inquiry form.
- During the manufacturing process of this product and any of its components and materials to be used, Panasonic does not intentionally use ozone-depleting substances stipulated in the Montreal Protocol and specific bromine-based flame retardants such as PBBs (Poly-Brominated Biphenyls) / PBDEs (Poly-Brominated Diphenyl Ethers). In addition, the materials used in this product are all listed as existing chemical substances based on the Act on the Regulation of Manufacture and Evaluation of Chemical Substances.
- With regard to the disposal of this product, please confirm the disposal method in each country and region where it is incorporated into your company's product and used.
- The technical information contained in this catalog is intended to show only typical operation and application circuit examples of this product. This catalog does not guarantee that such information does not infringe upon the intellectual property rights of Panasonic or any third party, nor imply that the license of such rights has been granted.

Panasonic Industry will assume no liability whatsoever if the use of our company's products deviates from the contents of this catalog or does not comply with the precautions. Please be advised of these restrictions.

Matters to Be Observed When Using This Product

(Film capacitor)

Use environments

- This product is intended for standard general-purpose use in electronic equipment, and is not designed for use in specific environments described below. Using the product in such specific environments or service conditions, therefore, may affect the performance of the product. Please check the performance and reliability of the product first before using the product.
 - (1) The product characteristics may deteriorate in environments where the product is exposed to water, oil, direct sunlight, ozone, UV-rays, radiant rays, etc. Do not use the product in these environments.
 - (2) High-humidity environment: When the capacitor is used in a high-humidity environment for a long period, moisture permeates its outer case reaching internal elements as time goes by.

This moisture oxidizes a film deposit or spraying of metal, thus causing the capacitor problems. As a result of moisture absorption, some types capacitors may have their capacitances increased.
 - (3) High temperature: There are cases where oil leaks from an ECQUG type capacitor used under high-temperature conditions (70°C or higher). However, it rarely happens and does not affect the quality and reliability of the capacitor at all. Nevertheless, avoid such a configuration in which the product and a component that may have a contact failure caused by oil are incorporated together in the same circuit set. If you have any question, please feel free to contact us.
 - (4) Gaseous atmosphere: Avoid using the capacitor in an oxidizing gas, such as a hydrogen chloride gas, hydrogen sulfide gas, and sulfurous acid gas. Using the capacitor in such a gaseous atmosphere results in oxidized film deposit (aluminum) or spraying of metal (zinc) that may cause an ignition or smoking incident.
 - (5) Resin coat: If you intend to coat the capacitor with a resin for the purpose of improving its resistance to moisture and gas or fixing a component, make separate inquiries to us about the matter.

A chemical solvent included in the resin permeates the metal sprayed parts or electrode (film deposit), which may cause the degradation of the capacitor characteristics. When curing resin, the resin generates chemical reaction heat (curing heat), which may have a negative influence on the capacitor.

When embedding the whole capacitor completely with a resin, sufficiently analyze/assess the effects of the thermomechanical stress created by thermal expansion/shrinkage.
 - (6) See to it that no dust gets deposited on the product. Dust deposition on the product causes current leakage, etc., leading to a degradation of the product characteristics.

Cleaning conditions

- The effects of cleaning processes on the capacitor vary widely, depending on its structure and materials. Generally speaking, the capacitor is hardly susceptible to a CFC-based solvent and an alcohol-based solvent but is affected by a solvent with high polarity in some cases. In many cases, the capacitor with leads is covered with an outer casing made of an epoxy resin highly resistant to chemicals and is therefore barely affected by a cleaner. We nevertheless advise you to clean the capacitor as quickly as possible. A chip-type laminated film capacitor (ECHU, ECWU, ECPU) is not protected with an outer jacket. During cleaning processes, solder flux or a cleaner deposited on an element of the capacitor, may be activated and flow into the capacitor, causing a problem.
- Ultrasonic cleaning may cause some problems, depending on the cleaner used and ultrasonic power output. Such problems include peeling of protective film, separation of an electrode due to resonance, and degraded capacitor characteristics. Make sufficient examinations/confirmations before carrying out ultrasonic cleaning.
- As a result of strict regulations on CFC-based and chlorine-based solvents, cleaners not containing such solvents have come into wide use. Some such alternative cleaners are, however, still harmful to the chip-type laminated film capacitor and could be harmful under improper cleaning conditions. Examine the cleaner sufficiently before using it. If you intend to use an alternative cleaner, please contact us in advance. Cleaning methods using an alternative cleaner include a method in which a high-pressure spray of cleaner (water) hits against the board.

In this case, the water pressure may cause the protective film to peel off from the element surface.

Research the cleaning method before executing it.
- Dry the cleaned capacitor sufficiently so that no cleaner remains thereon. An insufficient drying process allows the cleaner to remain on the element surface, in which case measurement of the insulation resistance of the capacitor may indicate an apparent drop in the insulation resistance.
- A recommended cleaner is isopropyl alcohol (IPA), which is a general industrial reagent. Recommended cleaning conditions include a cleaning temperature of 50°C and a cleaning time of 5 minutes or shorter, which apply equally to immersion cleaning, vapor cleaning, and ultrasonic cleaning.
- A list of cleaners that can be or cannot be used to clean the capacitor is shown on the next page. See the list for your reference. If you are not clear about whether or not a cleaner can be used to clean the capacitor, make sure to contact us.

<List of cleaners that can be or cannot be used to clean the capacitor>

		Cleaning conditions	Chip type	Lead type	Retail product*
Solvent-based	Alcohol-based	Ethanol Ultrasonic cleaning or immersion cleaning for 5 minutes	○	○	○
		Isopropyl alcohol (IPA) Ultrasonic cleaning or immersion cleaning for 5 minutes	○	○	○
	Silicon-based	FRW-17: ultrasonic cleaning at 60 °C for 5 minutes → FRW-1N: ultrasonic cleaning at 60 °C for 5 minutes → FRW-100: vapor drying at 100 °C for 1 minute	○	○	○
	Halogen-based	HCFC141b-MS Ultrasonic cleaning or immersion cleaning for 5 minutes	○	○	○
	Petroleum-based Hydrocarbon	P3 Cold Cleaner 225S Ultrasonic cleaning at 60 °C for 5 minutes → Ultrasonic rinsing with IPA at ordinary temperature for 5 minutes → Hot air drying at 40 °C for 5 minutes	○	○	○
		Toluene Ultrasonic cleaning or immersion cleaning for 5 minutes	×	○	○
Terpene-based	Terpene Cleaner EC-7 Spray cleaning at ordinary temperature for 5 minutes → Spray rinsing with pure water at 50 °C for 5 minutes → Hot air drying at 80 °C for 5 minutes	×	○	○	
Water-based	Pure water	Ultrasonic cleaning at 60 °C for 5 minutes → Non-blow drying at 85 °C for 5 minutes	×	○	○
	Surfactant	Cleanthrough 750H Ultrasonic cleaning at 60 °C for 5 minutes → Ultrasonic rinsing with pure water at 60 °C for 5 minutes → Hot air drying at 85 °C for 5 minutes	×	○	○
		Cleanthrough 750L Ultrasonic cleaning at 60 °C for 5 minutes → Ultrasonic rinsing with pure water at 60 °C for 5 minutes → Hot air drying at 85 °C for 5 minutes	×	○	—
			×	○	—
		Cleanthrough LC-841 Ultrasonic cleaning at 60 °C for 5 minutes → Ultrasonic rinsing with pure water at 60 °C for 5 minutes → Hot air drying at 85 °C for 5 minutes	×	○	○
		Pine Alpha ST-100S Ultrasonic cleaning at 60 °C for 5 minutes → Ultrasonic rinsing with pure water at 60 °C for 5 minutes → Hot air drying at 85 °C for 5 minutes	×	○	○
		Aqua Cleaner 210SET Shower cleaning at 60 °C for 1 minute → Ultrasonic rinsing with pure water at 60 °C for 5 minutes → Hot air drying at 85 °C for 5 minutes	×	○	○

* Retail product: ECWFE, ECWFG

<Uncleaned flux>

Uncleaned	Low-residue flux	ULF-500VS	○	○	○
	Non-active flux	AM-173	○	○	○

○ cleaner can be used, × cleaner cannot be used, — unconfirmed

Response to anomalies and handling conditions

- A dielectric film is not a fire-resistant material. In contrast, an ECQE type metallized polyester capacitor and ECWF type/ ECWH type metallized polypropylene capacitors each have an outer casing made of a fire-resistant epoxy resin (UL94 V-0).
- Because the capacitor described herein is made of a combustible material, it may generate smoke or even ignite when exposed to excessive heat. We therefore recommend you cover the capacitor with a fire-resistant material or fire-resistant case. When you use the capacitor at an operating voltage of 30 V AC or higher or 45 V DC or higher, to prevent noise between a line and the ground or between different lines, we recommend you cover a resin component near the capacitor with a fire-resistant material or fire-resistant case (to prevent a fire accident).
- When a different component in the same circuit has short-circuited or developed an open failure, see to it that a voltage or current higher than the rated voltage or current or excessive heat is not applied to the capacitor.
We define the maximum voltage that can be applied consecutively regardless of temperature, as rated voltage^{*1}. Be careful with the fact, however, that this rated voltage is different from rated voltages defined in JIS, IEC, etc.^{*2}
 - *1 Definition of the rated voltage by our company
We define the maximum voltage that can be applied continuously within the entire category temperature range, as the rated voltage. In a high-temperature condition where voltage reduction is necessary, a reduced maximum voltage is referred to as the rated voltage. Therefore, the maximum voltage that can be applied continuously at the category upper limit temperature is also referred to as the rated voltage.
 - *2 Definition of the rated voltage by JIS and IEC
JIS and IEC define the maximum voltage that can be applied continuously within a temperature range from the category lower limit temperature to the rated temperature, as the rated voltage. According to JIS and IEC, the maximum voltage that can be applied continuously at the category upper limit temperature is referred to as the category voltage. In a temperature range from the rated temperature to the category upper limit temperature, voltage reduction is necessary in some cases, where a reduced maximum voltage is referred to as temperature-dependent reduced voltage.
- Current that charges or discharges from the capacitor in a rapid charge or discharge causes short-circuit failure, open failure, etc., thus leading to the degradation of the capacitor characteristics. Make sure that the capacitor is charged or discharges with a resistance of 20 Ω/V to 1000 Ω/V or more in series. In a withstand voltage test, service life test, etc., where numbers of the capacitors are connected in parallel, each capacitor must have a resistance of 20 Ω/V to 1000 Ω/V or more connected in series thereto.
- Make sure that a sharp element (a screw driver, solder iron, tweezers, a chassis edge, etc.) does not hit the capacitor surface.
Do not apply an unnecessarily heavy load to the leads (for example, by reworking the leads).
- Accidentally dropping the capacitor on the floor may damage its characteristics. Do not use a capacitor when this happens. If you still use such a dropped capacitor, check its quality first.
- Be careful not to apply excessive force to the base of the leads of a lead-type capacitor. It causes the exterior resin near the base to crack.
- The chip-type capacitor has been developed under the assumption that it will be used as an ordinary surface-mounted component. Avoid using a capacitor in an unusual configuration (e.g., stacking the capacitors in two layers, setting the capacitor in a standing position, etc.). When you intend to use the capacitor in an unusual configuration, please contact us in advance.
- Take care to prevent water or dust from adhering to the terminal surface of the capacitor. Water or dust on the terminal causes current leakage, corrosion, etc.
- The capacitor emits a humming sound created by mechanical vibration of the dielectric film caused by a coulomb force between the positive and negative electrodes. In particular, the humming sound, in the form of a sound wave containing a source voltage distortion or harmonic component, is heard as a high-tone sound.
From the viewpoint of electrical characteristics, it poses no problem. However, when the capacitor is used at a frequency close to the audible frequency, check the humming sound.
- When the capacitor is used as a capacitor for preventing noise from an AC power supply (across-the-line capacitor), a source voltage is constantly applied to the capacitor and a surge voltage, such as a lightning surge, is applied to the capacitor as well. This may cause the capacitor to ignite or generate smoke. For such capacitors inserted between power lines, strict safety standards are set by individual countries, using products conforming to the safety standards is mandatory. When you are looking for across-the-line capacitors for use in domestic equipment, use capacitors conforming to overseas certification standards or capacitors listed below.

ECQE(F) : Rating 1000 V DC (125 V AC)
ECQE(F) : Rating 1250 V DC (125 V AC)

ECQE(F)/(B)/(T) : Rating 125 V AC (1A)
ECQE(F)/(T) : Rating 250 V AC (2A)

- When ECQE(F)1A /2A, ECQE(B)1A, and ECQE(T)1A /2A are used as across-the-line capacitors, they must satisfy at least one of the following conditions.
 - (1) A varistor with a varistor voltage specified in the following table or lower is connected in parallel with the capacitor.
 - (2) No pulse voltage higher than the pulse voltage specified in the following table is applied across both ends of the capacitor.
- When using a varistor together with the capacitor, confirm the varistor with the delivery specification sheet and use a varistor with no sign of surge-caused deterioration.

Capacitor rated voltage	Varistor voltage	Pulse voltage
125 V.AC (1A)	250 V	250 Vo-p
250 V.AC (2A)	470 V	630 Vo-p

- When using the capacitor in equipment requiring capacitors conforming to overseas certification standards, use capacitors (typical types) listed in the following table. To know about CQC standards in China, make an inquiry with us.

Shape	Type	Certification standards
Resin case	ECQUA	UL 60384-14(US), CSA E60384-14(CA), EN 60384-14(EU)
Resin case	ECQUL	UL 60384-14(US), CSA E60384-14(CA), EN 60384-14(EU)
Resin case	ECQUG	UL 60384-14(US), CSA E60384-14(CA), EN 60384-14(EU)

- Using the capacitor as a voltage dropper may result in a reduction in the capacitance. For example, when an abnormal voltage, such as surge voltage, is applied to the capacitor, a fuse inside the capacitor is activated, which reduces its capacitance. In a worst-case scenario, the capacitor no longer functions as a voltage dropper. Observe the capacitor carefully to see if any abnormal voltage is applied thereto. Such abnormal voltage to the capacitor may generate high voltage applied to the circuit load. To deal with such a problem, provide the circuit with a safety protection means.

Reliability and product life

- Capacitor characteristics change, depending on ambient environment conditions under which the capacitor operates. Even when the capacitor is just left as it is, humidity in the air can infiltrate the capacitor and cause a slight change in its capacitance. An extent to which the capacitance changes in this situation varies depending on a dielectric material, an outer casing material, a structure, etc. We take these characteristics changes into consideration before shipping out the capacitor. However, unless a separate agreement is made, our guarantee for the specified capacitance value will be effective only up to the delivery date.
- When using a capacitor in a circuit that requires precise capacitor elements, such as time constant, use polypropylene-based capacitors with less time-dependent change, such as ECWFD, ECWF(A), ECWF(L), ECWH(A), PPS-based ECHU(X), and ECHU(C).
- A product conforming to "AEC-Q200" refers to a product having passed some or all of the evaluation test items defined in AEC-Q200. To know the detailed specifications of individual products or specific evaluation test scores, please contact us. We issue a delivery specification sheet for each product ordered. Please confirm with the sheet when you place an order with us.

Circuit design (working voltage)

- The maximum working voltage applicable to a capacitor varies, depending on the voltage waveform, current waveform, frequency, ambient temperature (surface temperature), capacitance, etc. When using a capacitor, check the voltage waveform and current waveform applied across both terminals of the capacitor and the operating frequency and make sure that these are within specified values. When the frequency is high, some product types take different allowable voltages. You can confirm detailed information about this matter on delivery specification sheets.
- The rated voltage is the maximum voltage that can be applied continuously within the category temperature range. Operating the capacitor with a voltage higher than the rated voltage leads to dielectric breakdown of the capacitor film, which may cause a short-circuit failure. Service lives of capacitors operating at the maximum rated voltages vary, depending on their types.
- When a voltage higher than the rated voltage is applied to the capacitor, it does not cause a short circuit failure immediately because of the self-recovery ability of the capacitor, however, a drop in the insulation resistance may occur, which can lead to smoke generation or ignition under certain circuit conditions.
- Do not use a noise-preventing capacitor (AC rated voltage type) in a high-frequency circuit. It may cause smoke generation or ignition under certain service conditions. Rated voltages of capacitors for electronic equipment, except that of a special types, are usually indicated as DC voltage.

■ The capacitor has an upper limit service temperature (surface temperature) determined in accordance with the type of a dielectric material making up the capacitor. When using the capacitor at a temperature higher than the rated temperature, confirm the following classification table because some types capacitors require voltage reduction. Even when the capacitor can be used at a temperature higher than the rated temperature, make sure that voltage reduction is carried out to keep the surface temperature equal to or lower than an upper limit service temperature specified in the following table.

A capacitor used at a high frequency shows a self-temperature rise. A voltage reduction rate shown in the following table, therefore, cannot be applied in this case.

The AC rated voltage type capacitor does not need a temperature-dependent voltage reduction.

<Rated temperatures, category upper limit temperatures, and voltage reduction rates classified by type in the case of DC working voltage>

Dielectric material	Type	Rated temperature	Category upper limit temperature (maximum service temperature)	Rated voltage in a temperature range equal to or higher than the rated temperature (voltage reduction rate)
Polyester (PET)	ECQE(F)	85 °C	105 °C	1.25%/ °C
	ECQE(B)			
	ECQE(T)			
Polypropylene (PP)	ECWF(A) Rating 250 V DC	105 °C	105 °C	Voltage reduction is unnecessary.
	ECWF(L)			
	ECWH(A)			
	ECWH(C)			
	ECWF(A) Rating 450 V DC	85 °C	105 °C	1.25%/ °C
	ECWF(A) Rating 630 V DC			
	ECWH(V)			
ECWFE Rating 450 V DC	85 °C	105 °C	1.0%/ °C	
ECWFD Rating 630 V DC				
ECWFE Rating 630 V DC	85 °C	110 °C	0.62%/ °C	
ECWFD Rating 450 V DC				
ECWFG Rating 630 V DC	85 °C	110 °C	1.0%/ °C	
Polyethylene naphthalate (PEN)	ECWU(X)	105 °C	105 °C	Voltage reduction is unnecessary.
	ECWU(C)	85 °C	125 °C	1.25%/ °C
	ECWU(V16)	85 °C	85 °C	Voltage reduction is unnecessary.
Polyphenylene sulfide (PPS)	ECHU(X) Rating 16 V DC	125 °C	125 °C	Voltage reduction is unnecessary.
	ECHU(X) Rating 50 V DC (0.0001 μF to 0.10 μF)			
	ECHU(X) Rating 50 V DC (0.12 μF to 0.22 μF)	105 °C	125 °C	1.25%/ °C
	ECHU(C)	105 °C	105 °C	Voltage reduction is unnecessary.
Acrylic resin	ECPU(A)	85 °C	85 °C	Voltage reduction is unnecessary.

※Rated temperature: upper limit temperature that can be used continuously without involving voltage reduction (which includes the self-temperature rise value)

※Category upper limit temperature: upper limit temperature that can be used continuously when voltage reduction is implemented (which includes the self-temperature rise value)

<Voltage reduction example>

When the rated temperature is 85 °C and the category upper limit temperature is 105 °C, voltage reduction is carried out at a reduction rate of 1.25 %/ °C in a temperature range of 85 °C or higher.

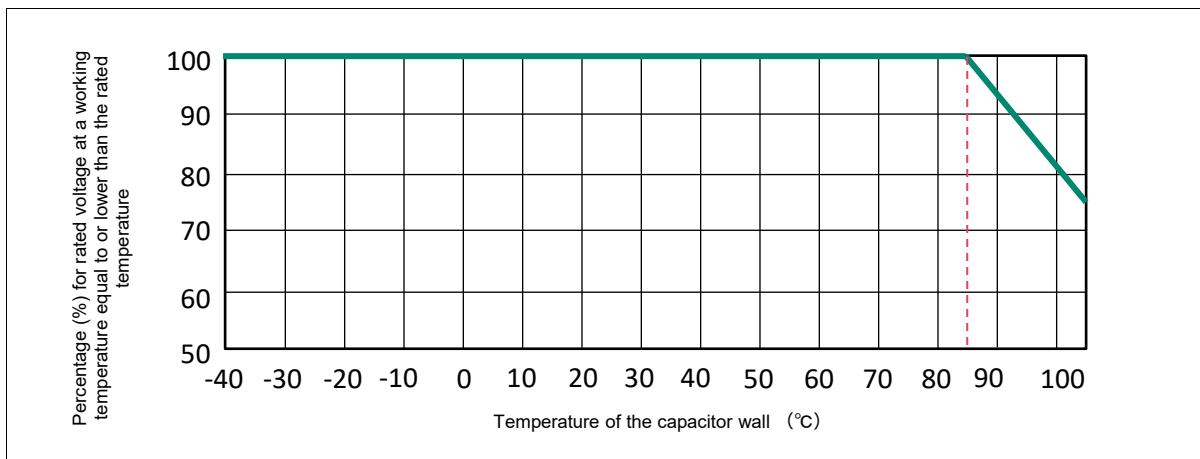

- Use the noise-preventing capacitor (AC rated voltage type) on the primary power circuit. This capacitor is designed on the assumption that a 50 Hz or 60 Hz sine wave voltage is applied to the capacitor. When using a capacitor with a DC rated voltage type in an AC circuit, see "Voltage at Which DC Rated Voltage Type Capacitor Can be Used in AC Circuit."
" Do not use this type of capacitor on the primary power circuit.
- When a capacitor is used at a high frequency, its self-heating poses a risk of thermal runaway (smoke generation, ignition). Reduce the working voltage according to the example shown below. For capacitors used at a high frequency, we recommend ECHU(X)/(C), ECWF(A)/(L), and ECWH(A)/(C)/(V).

<Example of working voltage reduction>

Capacitor: ECWF2154JA (250 V DC, 0.15 μF) Working frequency: 40 kHz (sine wave)
Allowable current value (entered in the delivery specification sheet): 2.0 Arms at 40 kHz

$$V = \frac{I}{2\pi fC} = \frac{2.0}{2 \times 3.14 \times 40 \times 10^3 \times 0.15 \times 10^{-6}} = 53 \text{ Vrms}$$

According to the above equation, the AC working voltage (50 Hz or 60 Hz sine wave voltage) of ECWF(A) operating at 40 kHz and 53 Vrms is calculated at 125 Vrms. This indicates that using ECWF(A) at a high frequency causes its allowable voltage to drop. Note that this equation cannot be applied to a working voltage not in a sine waveform, in which case please contact with us.

- Make sure that the peak value of a pulse voltage (Vo-p) applied across both ends of the capacitor is equal to or lower than the rated DC voltage. When the capacitor is used at a high frequency, its self-heating impairs the voltage endurance characteristics and may lead to destruction of the capacitor. Measure the self-temperature rise value of the capacitor and keep it equal to or lower than the specified value.
- When a voltage higher than the rated voltage (allowable voltage) is applied to the capacitor as a result of unusual circuit behavior caused by a failure of a different component, provide the capacitor with a means of safety protection.

Circuit design (working current)

- Because of its low internal impedance, the capacitor carries an extremely large current flow, depending on the circuit in which the capacitor is incorporated. Particularly, a high pulse current could flow through the capacitor when the power supply is turned on or off. Make sure to check whether a high pulse current is flowing through the capacitor. When the capacitor is used in a high-frequency circuit, such as an inverter circuit and switching circuit, a large current may flow through the capacitor. Be careful in such cases.
- A current flow exceeding the allowable current value may put the capacitor in a low-capacitance or open state or cause the capacitor to generate heat. This may result in degraded voltage endurance performance or short circuit, thus leading to smoke generation, ignition, etc. When using the capacitor, keep a capacitor current and temperature equal to or lower than the allowable current value and self-temperature rise value specified in the delivery specification sheet.
- It is necessary that the allowable current in breakdown mode be examined in terms of both pulse current (peak current) and continuous current (RMS current). Confirm that both pulse current and continuous current are equal to or lower than the allowable current value and then use the capacitor.
- The frequency characteristics of the loss tangent ($\tan\delta$) of a capacitor vary depending on the type of a dielectric material used. For this reason, a different allowable RMS current for a given working frequency shows depending on the product type. When a capacitor is used at a high frequency, in particular, its loss tangent ($\tan\delta$) gets larger, a current flow larger than the RMS current causes the capacitor to thermally runaway, which may lead to smoke generation or ignition. Using the capacitor at a high frequency, therefore, requires special caution. Please let us know the operating conditions for the capacitor to give you detailed advice. Otherwise, keep the self-temperature rise value and surface temperature of the capacitor within the allowable range even in the most unfavorable operation conditions.

- The RMS current (effective current) varies depending on the capacitance. The following graphs show allowable RMS currents (effective currents) of typical capacitor types by frequency/capacitance. When actually using these capacitors, measure their voltage/current waveforms and ambient temperatures/self-temperature rise values and give us these measurements with your inquiries.

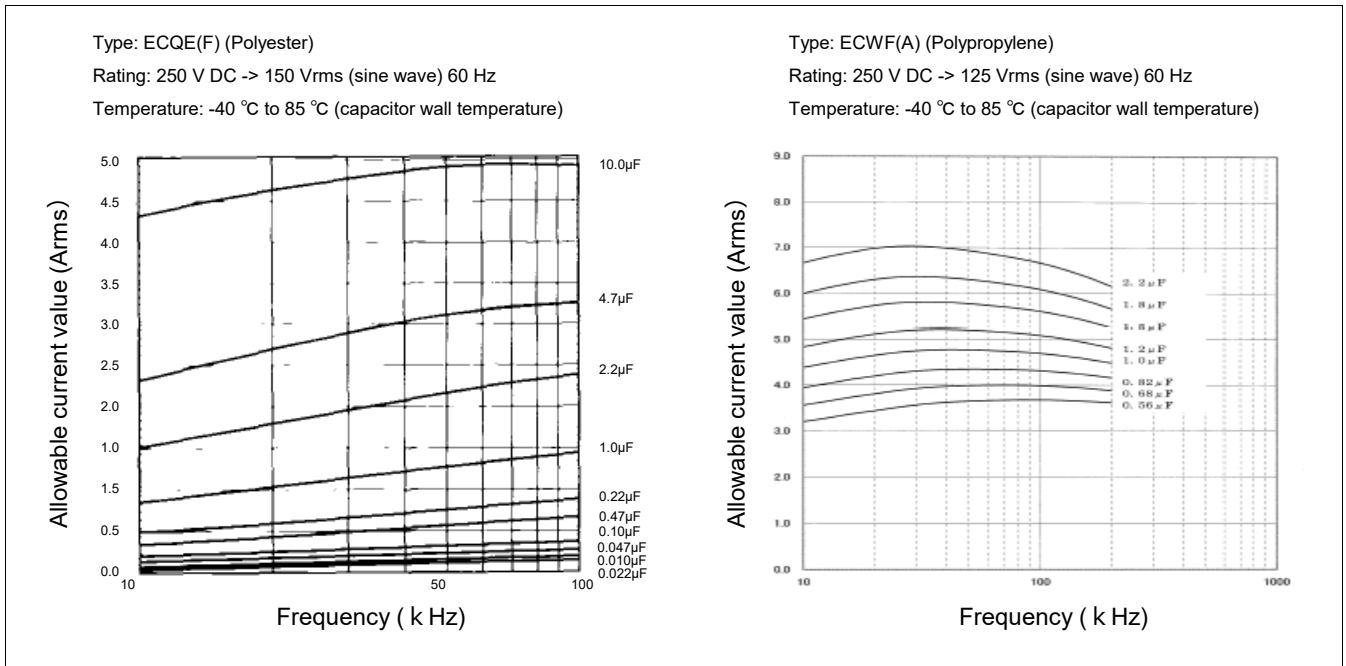

- When the capacitor is used in a switching circuit or snubber circuit, an instantaneous flow of large pulse current causes the capacitor to locally generate heat. As a result, the film deposit scatters off, which may decrease the capacitance of the capacitor or put the capacitor in an open state. This local heating may trigger a smoke generation or ignition incident.
- A pulse current value (10000 times) can be given as the product of dV/dt (V/ μ s) and a capacitance (μ F) that are specified in the delivery specification sheet. dV/dt is determined by the element structure.
- When the capacitor is used in a large-current pulse circuit, keep the pulse current value within the allowable pulse current (Ao-p). When applying a pulse current 10000 times or more, please contact us to discuss the matter separately.

- When a voltage V (V) is applied to a capacitor C (farad or F), a charge quantity Q (C) is given as $Q = C \cdot V$.
At this time, a charge current I (A) flowing through the capacitor is given as $I = dQ/dt$. It follows, therefore, that a pulse current I (A) is given as the product of a capacitance C (μ F) and a voltage variation per time dV/dt , that is, $I = C \cdot dV/dt$.

<Allowable dV/dt value of ECQE(F) to which a pulse current is applied 10000 times or less>

Capacitance (μ F)	Type			
	ECQE(F)	ECQE(F)	ECQE(F)	ECQE(F)
	100 V DC	250 V DC	400 V DC	630 V DC
103 (0.010)			131	273
123 (0.012)				
153 (0.015)				
183 (0.018)				
223 (0.022)				
273 (0.027)				
333 (0.033)				
393 (0.039)				
473 (0.047)				
563 (0.056)				
683 (0.068)				
823 (0.082)				
104 (0.10)				
124 (0.12)				
154 (0.15)				
184 (0.18)				
224 (0.22)				
274 (0.27)				
334 (0.33)				
394 (0.39)				
474 (0.47)				
564 (0.56)				
684 (0.68)				
824 (0.82)				
105 (1.0)				
125 (1.2)				
155 (1.5)				
185 (1.8)				
225 (2.2)				
275 (2.7)				
335 (3.3)				
395 (3.9)				
475 (4.7)				
565 (5.6)				
685 (6.8)				
825 (8.2)				
106 (10.0)				

From the above table, which indicates that the allowable dV/dt value of ECQE4224KF (rated voltage 400 V DC, capacitance 0.22 μ F) is 37, the allowable pulse current value of ECQE4224KF is calculated at 8 A. Ensure, however, that the RMS current value is equal to or lower than the allowable RMS current value.

- When a voltage V (V) is applied to a capacitor C (farad or F), the charge quantity Q (C) is given as $Q = C \cdot V$.
At this time, the charge current I (A) flowing through the capacitor is given as $I = dQ/dt$. It follows, therefore, that the pulse current I (A) is given as the product of the capacitance C (μF) and the voltage variation per time dV/dt, that is, $I = C \cdot dV/dt$.

<Allowable dV/dt value of ECQE(F) to which a pulse current is applied 10000 times or less>

Capacitance (μF)	Type			
	ECQE(F)	ECQE(F)	ECQE(F)	ECQE(F)
	100 V DC	250 V DC	400 V DC	630 V DC
103 (0.010)				
123 (0.012)				
153 (0.015)				
183 (0.018)			131	
223 (0.022)				273
273 (0.027)				
333 (0.033)				
393 (0.039)		48		
473 (0.047)				
563 (0.056)			78	
683 (0.068)				
823 (0.082)				
104 (0.10)				
124 (0.12)				116
154 (0.15)				
184 (0.18)				
224 (0.22)				
274 (0.27)		33	37	
334 (0.33)				
394 (0.39)				63
474 (0.47)				
564 (0.56)				
684 (0.68)	22			
824 (0.82)		18	22	
105 (1.0)				
125 (1.2)				
155 (1.5)				48
185 (1.8)	11		18	
225 (2.2)				
275 (2.7)		10		
335 (3.3)				
395 (3.9)				
475 (4.7)				
565 (5.6)				
685 (6.8)	6			
825 (8.2)		8		
106 (10.0)				

From the above table, which indicates that the allowable dV/dt value of ECQE4224KF (rated voltage 400 V DC, capacitance 0.22 μF) is 37, the allowable pulse current value of ECQE4224KF is calculated at 8 Ao-p. Ensure, however, that the RMS current value is equal to or lower than the allowable RMS current value.

Circuit design (working temperature)

- When the capacitor is used in an AC circuit, especially in a high-frequency circuit, the capacitor generates heat because of the alternating current flowing therethrough. If this self-heating by the capacitor is excessive, the capacitor may deteriorate or generate smoke or even ignite. Confirm the self-temperature rise value of the capacitor under the actual service condition and use the capacitor at the self-temperature rise value equal to or lower than the specified self-temperature rise value.

Measure the self-temperature rise value at room temperature in a windless condition. Refer to the delivery specification sheet to check detailed information on the self-temperature rise value.

The specified self-temperature rise value varies depending on capacitor types. For more detailed information about this matter, please contact us.

- Because the working temperature range of a capacitor varies depending on dielectric materials (film types), the working temperature range in which the capacitor can be used is specified for each capacitor type.

Note, however, that working temperature ranges listed in a catalog are surface temperatures which are different from ambient temperatures. When using the capacitor, make sure that (ambient temperature + self-temperature rise value (within the specified value)), that is, the surface temperature of the capacitor is within the working temperature range.

- If the capacitor is used in a temperature condition above the working temperature range, its loss tangent ($\tan \delta$) gets larger, inducing self-heating, which leads to exceeding the allowable value. As a result, the dielectric film deteriorates which can cause a short circuit failure that may lead to smoke generation or ignition. When a heat dissipation plate of a different component or resistance generating high heat is present near the capacitor, radiant heat from such an element is applied to a part of the capacitor, in which case the temperature of the capacitor can exceed the working temperature range and smoke generation or ignition may occur. Make sure to check the surface temperature of elements that serve as a heat source.

Board design

- The chip-type laminated film capacitor is mounted directly on the board without a lead interposed between the capacitor and the board. Because of this configuration, if the thermal expansion coefficient of the capacitor and that of the board differ widely, due to temperature change, etc., after chip mounting, it creates mechanical stress which is applied to the capacitor. This deforms the capacitor body or cracks its soldered part, thus impairing its performance. Examine and check the capacitor sufficiently before mounting it on the board. In particular, when using a ceramic board, please contact us before mounting the capacitor.

<Thermal expansion coefficients of boards and chip-type laminated film capacitors>

Type Item	Chip-type laminated film capacitor			Resin board			Ceramic board
	ECHU(X)/(C) (PPS film)	ECWU(X)/(C) (PEN film)	ECPU(A) (Plastic film)	Paper phenol	Paper epoxy	Glass epoxy	Alumina
Thermal expansion coefficient ($\times 10^{-6}/^{\circ}\text{C}$)	22	10	70	1 ~ 30	1 ~ 15	1 ~ 25	7 ~ 8

- Radiant heat from a heat-carrying component present near the capacitor may raise the temperature of the capacitor above the category temperature range. Be careful in such cases. The chip-type capacitor does not have the outer casing that the lead-type capacitor has. If an exposed part of a live component is present near the capacitor, a short circuit may be created through the capacitor. Exercise special caution when determining the location of the capacitor.
- If the land area of the capacitor is large, a tombstone phenomenon (chip rising) is likely to occur when the volume of solder is not proper. Give each type of capacitor recommended land dimensions as much as possible, even though it is disadvantageous from the viewpoint of ensuring the moulder has sufficient mount clearance.

Mounting conditions (chip-type) * Target capacitors: ECHU, ECWU, and ECPU

- In the flow soldering process, a chip component is dipped in melted solder and resulting in a high temperature of the component. The film capacitor has low resistance to heat. Avoid soldering it using the flow soldering process. Applying heat directly to a capacitor from the lower surface of the printed board for repair work (using a hot plate, etc.) may result in the degradation of the capacitor. This process must also be avoided.

- Reflow soldering is a soldering method in which the proper amount of solder paste is deposited on the fitting land of the surface-mounted board, the chip-type laminated film capacitor is placed on the land, and heat is applied to the capacitor to melt the solder. We recommend the temperature profile shown in the following table for the reflow soldering process. Note, however, that more than two reflow soldering cycles are not allowed and that the second reflow cycle must be carried out after the capacitor temperature returns to normal temperature following the end of the first reflow cycle.

Soldering	Item	Soldering condition	Mater to note
	<Reflow soldering> The capacitor and the board are heated in a heat-resistant furnace or an infrared furnace.		The capacitor temperature varies depending on the type of the board material and the heat source. Use a glass epoxy board of 115 mm by 50 mm and 0.8 t as the standard board to check the capacitor temperature.

- Because the chip-type laminated film capacitor is not protected with an outer casing, an activator (halogen, etc.) in solder paste may corrode the inner deposit electrode, which leads to the degradation of the capacitor characteristics, such as a drop in the capacitance and an increase in the loss tangent ($\tan\delta$). Use solder paste with halogen content of 0.1 wt%.
- When cleaning the capacitor right after soldering it, make sure that its surface temperature is 60 °C or lower.
- Maximum surface temperatures capacitors reach during the reflow process are as follows: 260 °C at ECHU(X)/(C), 250 °C at ECWU(X)/(C), and 240 °C at ECPU(A).
A surface temperature higher than these temperatures causes a capacitor problems with its appearance and electrical characteristics, in which case the reliability of the capacitor cannot be guaranteed.
- ECWU(X)/(C) and ECPU(A) are put in moisture proofing packages. Once the package is unsealed, the capacitor absorbs moisture and its resistance to soldering heat drops. Check the note on the package that gives you the instructions you should follow after unsealing the package. Specific instructions to follow after unsealing the package are stated in the delivery specification sheet.
- When using a solder iron, sufficiently preheat the board land with the iron tip and then carry out soldering work. Do not put the iron tip directly on the body or electrode of a chip-type laminated film capacitor. Particularly, do not bring the iron tip into contact with a side face (sectional surface) of the capacitor. A hot solder iron coming in contact with such parts may cause the degradation of the capacitor characteristics, such as lower insulation resistance and short circuit.
- Avoid mounting a number of chip-type laminated film capacitors on a board using a solder iron. This process makes temperature control difficult and may lead to the degradation of the capacitor characteristics. Avoid reusing a capacitor (component) once removed with a solder iron.

		ECHU(X)/(C)	ECWU(X)/(C)	ECPU(A)
		270°C max. – 4s max.	260°C max. – 4s max.	280°C max. – 4s max.
Solder iron use condition				
	Solder iron wattage: 30 W			

Mounting conditions (lead-type) * Target capacitors: ECQE, ECWF, ECWH, and ECQU

■ The heat-resistant temperature of a capacitor varies depending on the type of a dielectric film used and on the structure and manufacturing method of the capacitor. When mounting the capacitor on a board, set the mounting temperature such that the internal temperature of the capacitor (see the figure on the right) is equal to or lower than the mounting heat-resistant temperature listed in the following table.

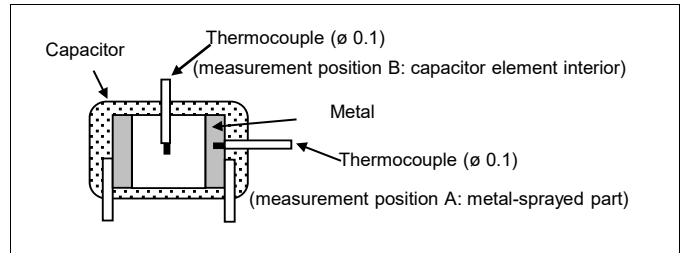

When a capacitor is sent through a high-temperature atmosphere after being subjected to the (flow) soldering process, check the mounting temperature including the temperature of the capacitor in the high-temperature atmosphere.

Dielectric material	Type	Mounting heat-resistant temperature (peak value)	
		Measurement position A	Measurement position B
Polypropylene-based	ECWF(L) 400 V / 0.022 μF to 0.11 μF, ECWF(L) 630 V / 0.01 μF to 0.043 μF, ECWF(A)	135 °C	125 °C
	ECWF(L) 400 V / 0.12 μF to 2.4 μF, ECWF(L) 630 V / 0.047 μF to 1.3 μF, ECWFE 630 V, ECWFG 630 V	145 °C	125 °C
	ECWH(A), ECWH(V), ECWFD 630 V	135 °C	125 °C
	ECWH(C)	140 °C	125 °C
	ECWFD 450 V	135 °C	—
	ECQUA, ECWFE 450 V	125 °C	—
Polyester-based	ECQE(F)	—	120 °C
	ECQE(B), ECQE(T), ECQUL, ECQUG	160 °C	—

■ Set temperature conditions for soldering within the ranges shown in the graph on the right (make sure to confirm that the set temperature conditions are equal to or lower than the mounting heat-resistant temperature because temperature conditions vary significantly depending on the equipment structure). Carry out no more than two soldering cycles and in such a way that the second soldering cycle is only carried out after the capacitor temperature returns to a normal temperature following the end of the first cycle.

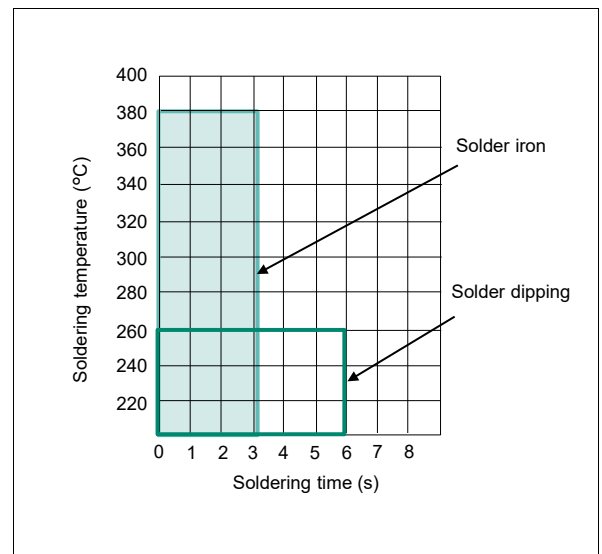

<Condition example>

Printed circuit board	Board thickness of 0.8 mm or more
Preheating	At 120 °C or less for 1 minute or less (the preheating time and final temperature reached around the land on the back of the board)
Capacitor body	There is a certain type of capacitor that must be lifted upward from the printed board. (processed product)

- Since the mounting heat-resistant temperature of the capacitor is low, avoid running the capacitor through an adhesive curing oven for fixing chip components. In the oven, the capacitor is exposed to heat higher than the mounting heat-resistant temperature, which causes the dielectric film to thermally shrink, thus causing a short failure.
- When a film capacitor is used with chip components, mount the film capacitor and solder it after the adhesive has cured.
- Do not perform reflow soldering for the capacitor. During reflow soldering, if heat higher than the mounting heat-resistant temperature is applied to the capacitor, it could damage the exterior resin and impair the capacitor characteristics.

- When the capacitor is mounted on a multilayer board or has copper leads, the internal temperature of the capacitor readily increases because of the high heat conductivity of the copper leads, and therefore the capacitor temperature may rise above the mounting heat-resistant temperature. In such a case, contact us for some advice.
- Excessive heat stress that is applied to the capacitor during the mounting process causes the dielectric film to thermally shrink, which may make the connection of the metal-sprayed part unstable. Current flowing through the capacitor in this state may reduce its capacitance and put it in open mode. When the capacitor is laid down on its side on the board, solder the capacitor so that a thermocouple inserted between the capacitor and the board shows 125 °C or lower.

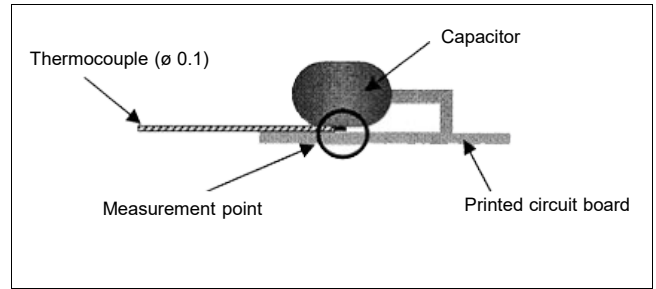

Mounting conditions (temperature measurement)

- When using a chip-type capacitor, measure the temperature profile of the mounted capacitor by the following method so that the capacitor is soldered at a temperature equal to or lower than the heat-resistant temperature.

<Creating a measurement sample>

Bond a thermocouple (ø 0.1 T) to the upper surface of the capacitor with an adhesive.

<Measuring a temperature profile>

As shown in the following diagram, connect the same type of thermocouple (3 m to 4 m) as the thermocouple bonded to the capacitor, to the measuring device.

Mount the sample capacitor on the board, subject the capacitor to the soldering process, and measure the temperature profile of the capacitor.

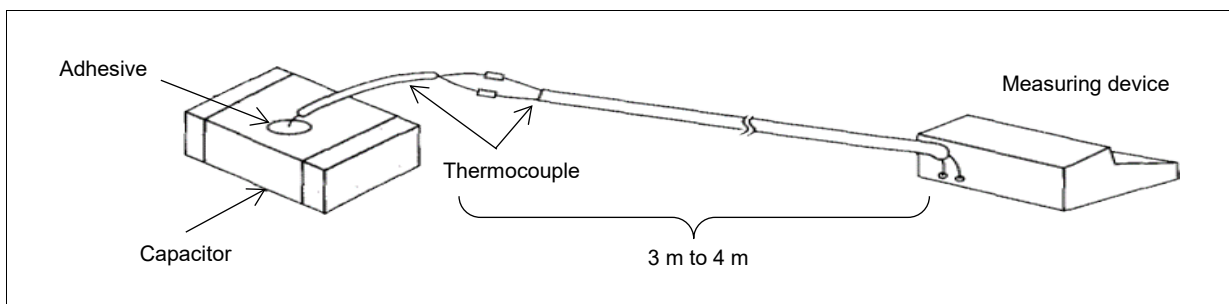

- When using a lead-type capacitor with a low mounting heat-resistant temperature, measure the temperature profile of the mounted capacitor by the following method so that the capacitor is soldered at a temperature equal to or lower than the heat-resistant temperature.

<Creating a measurement sample>

Drill a hole of 0.3 mm to 0.8 mm in diameter on the top of the capacitor, the hole being deep enough to reach the central part of the capacitor, and insert a thermocouple (ø 0.1 T) in the hole, affix the thermocouple with an adhesive.

<Measuring a temperature profile>

As shown in the following diagram, connect the same type of thermocouple (3 m to 4 m) as the thermocouple bonded to the capacitor, to the measuring device.

Mount the sample capacitor on the board, subject the capacitor to the soldering process, and measure the temperature profile of the capacitor.

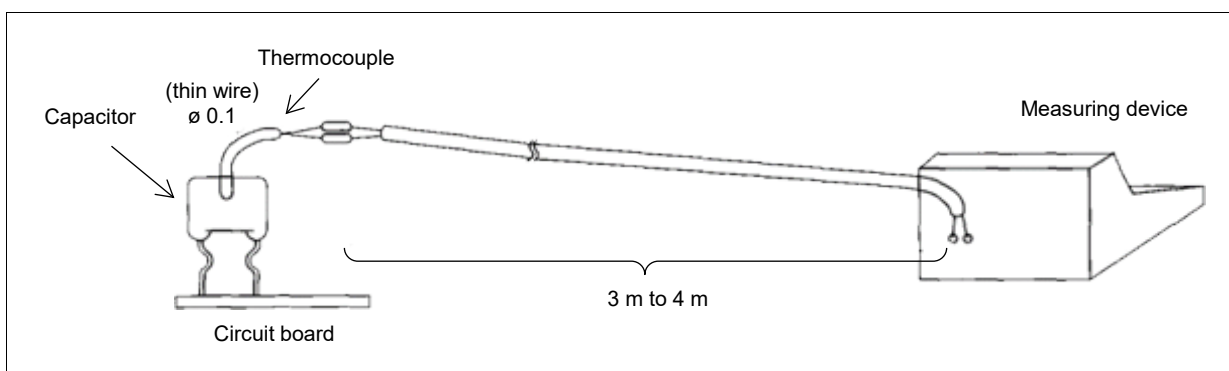

Storage conditions

- Do not store the capacitor in a place where moisture, dust, or corrosive gas (hydrogen chloride, hydrogen sulfide, sulfur dioxide, ammonia, etc.) is present. It may impair the solderability of the external electrodes.
- Avoid a high-temperature/high-humidity place and keep the capacitor in a place where the temperature/humidity condition is controlled at 35 °C and 85%RH or lower.
- A capacitor kept in storage for a long period will have oxidized leads surface resulting in lower solderability. Make the storage period as short as possible (about 6 months).
Storage conditions vary depending on capacitor types. For more detailed information, please contact us.



















Reference information

Guidelines

Before using the capacitor, make sure to acquire our delivery specification sheet and confirm service conditions. If you find measurement values exceeding specified values in the specification sheet or have any question, feel free to contact us. We also advise you to refer to RCR-1001B "Safety Application Guide on Components for Use in Electronic and Electrical Equipment" and JEITA RCR-2350D "Safety Application Guide for Fixed Plastic Film Capacitors for Use in Electronic Equipment."

Summary of Products

● Electronic Equipment Use

	Dielectric	Series	Appearance	Operating temp. *	Rating	Structure・Feature	Application
Stacked metallized film chip capacitor	Stacked metallized PPS film chip capacitor	ECHU(X)		-55 °C to +125 °C	0.00010 μF to 0.22 μF [DC] 16 V, 50 V	<ul style="list-style-type: none"> ● Non-inductive, Stacked ● Tight C-Tol. ● Reflow soldering 	● High density mounting
		ECHU(C)		-55 °C to +105 °C	0.010 μF to 0.22 μF [DC] 100 V	<ul style="list-style-type: none"> ● Non-inductive, Stacked ● Tight C-Tol. ● Reflow soldering 	<ul style="list-style-type: none"> ● High density mounting ● Resonance circuit for LCD B/L inverter unit
	Stacked metallized PEN film chip capacitor	ECWU(X)		-55 °C to +105 °C	0.0010 μF to 0.010 μF [DC] 100 V	<ul style="list-style-type: none"> ● Non-inductive ● Reflow soldering 	● High density mounting
		ECWU(C)		-55 °C to +125 °C	0.0010 μF to 1.0 μF [DC] 100 V to 630 V	<ul style="list-style-type: none"> ● Non-inductive ● Reflow soldering 	<ul style="list-style-type: none"> ● Ringer circuit telephone PBX ● DC Blocking for xDSL
	ECWU(V16)		-55 °C to +85 °C	0.0010 μF to 0.12 μF [DC] 250 V	<ul style="list-style-type: none"> ● Non-inductive ● Reflow soldering 	<ul style="list-style-type: none"> ● Ringer circuit telephone PBX ● DC Blocking for xDSL 	
Stacked metallized Plastic film chip capacitor	NRFND ECPU(A)		-40 °C to +85 °C	0.10 μF to 1.0 μF [DC] 16 V	<ul style="list-style-type: none"> ● Non-inductive ● Reflow soldering 	<ul style="list-style-type: none"> ● Noise suppressor ● Audio circuit 	
Metallized type	Metallized polyester film capacitor	★ECQE(F)		-40 °C to +105 °C	0.0010 μF to 10 μF [DC] 100 V to 1250 V [AC] 125 V, 250 V	<ul style="list-style-type: none"> ● Epoxy resin coating ● Wide capacitance range 	<ul style="list-style-type: none"> ● General purpose ● Noise suppressor
		ECQE(B)		-40 °C to +105 °C	0.010 μF to 4.7 μF [DC] 250 V [AC] 125 V	<ul style="list-style-type: none"> ● Epoxy resin coating ● Miniaturization of ECQE(F) type 	<ul style="list-style-type: none"> ● General purpose ● Noise suppressor
		ECQE(T)		-40 °C to +105 °C	0.010 μF to 10 μF [DC] 250 V to 630 V [AC] 125 V, 250 V	<ul style="list-style-type: none"> ● Epoxy resin coating ● Excellent moisture resistance 	● Electric circuit of high humidity equipment
	Metallized polypropylene film capacitor	ECWF(L)		-40 °C to +105 °C	0.010 μF to 2.4 μF [DC] 400 V, 630 V	<ul style="list-style-type: none"> ● Epoxy resin coating ● Low D.F ● Excellent moisture resistance 	● High frequency high current circuit
		ECWF(A)		-40 °C to +105 °C	0.10 μF to 6.8 μF [DC] 250 V to 630 V	<ul style="list-style-type: none"> ● High safety (with safety function) ● Miniaturization of ECWF(L) type ● Low D.F 	<ul style="list-style-type: none"> ● Active filtering circuit ● High frequency high current circuit
		ECWFD		-40 °C to +110 °C	0.1 μF to 4.7 μF [DC] 450 V	<ul style="list-style-type: none"> ● High safety (with safety function) ● Epoxy resin coating 	<ul style="list-style-type: none"> ● Active filtering circuit ● High frequency high current circuit
				-40 °C to +105 °C	0.01 μF to 4.7 μF [DC] 630 V	<ul style="list-style-type: none"> ● Low D.F ● Miniaturization of ECWF(A) type 	
		ECWFE		-40 °C to +105 °C	0.10 μF to 4.7 μF [DC] 450 V, 630 V	<ul style="list-style-type: none"> ● High safety (with safety function) ● Box type ● Low D.F 	<ul style="list-style-type: none"> ● Active filtering circuit ● High frequency high current circuit
		ECWH(V)		-40 °C to +105 °C	0.0010 μF to 0.10 μF [DC] 1000 V to 2000 V	<ul style="list-style-type: none"> ● Epoxy resin coating ● Low D.F ● Small in size 	● High frequency high current circuit
		ECWH(A)		-40 °C to +105 °C	0.0010 μF to 0.047 μF [DC] 800 V, 1600 V	<ul style="list-style-type: none"> ● Epoxy resin coating ● Low D.F ● Miniaturization of ECWH(V) type 	● General resonance circuit
	ECWH(C)		-40 °C to +105 °C (+85 °C)	0.0024 μF to 0.33 μF [DC] 630 V to 3000 V	<ul style="list-style-type: none"> ● Epoxy resin coating ● Low D.F 	<ul style="list-style-type: none"> ● General resonance circuit ● Microwave oven ● IH resonance circuit 	
	TMF		-25 °C to +85 °C	(Smoothing circuit) 1 μF to 10 μF [AC] 150 V to 220 V [DC] 350 V to 630 V (Resonance circuit) 0.01 μF to 4.0 μF [AC] 300 V to 2300 V [DC] 500 V to 1200 V	<ul style="list-style-type: none"> ● Wide voltage range up to 2300 V[AC] ● High frequency and high current capability ● Low loss/Low ESR ● Long life time / High reliability ● Flame retardant 	<ul style="list-style-type: none"> ● General resonance and smoothing circuits for IH and Industry 	
Interference suppressors (Safety standard approval capacitors)	Metallized polypropylene film capacitor	NRFND ECQUA		-40 °C to +110 °C	0.0082 μF to 10.0 μF [AC] 275 V	<ul style="list-style-type: none"> ● Box type ● UL, CSA, ENEC Approved (Class X2) 	Worldwide ● Noise suppressor for AC line
		NRFND ECQUB			0.001 μF to 1.0 μF [AC] 300 V	<ul style="list-style-type: none"> ● Box type ● UL, CSA, ENEC Approved (Class Y2/X1)(Class X1) 	

* Operating temp. : Including temperature-rise on unit surface.





* Refer to each product page for details.

★ Some part number have been designated Not Recommended for New Design.









NRFND Not recommended for new design

Summary of Products

● **AC Motor Use**

Dielectric	Series	Appearance	Operating temp. * *	Rating	Structure·Feature	Application
Film capacitor for AC motor	AMF		-25 °C to +70 °C	10 μF to 40 μF [AC] 180 V to 440 V	<ul style="list-style-type: none"> ● High safety (with safety function) ● High reliability ● Small size, lightness, and low loss 	● Motor and compressor (for running)
	NRFND DMF		-25 °C to +70 °C	10 μF to 60 μF [AC] 180 V to 450 V	<ul style="list-style-type: none"> ● High safety (with safety device) ● High reliability, safety standard approval ● Small size, lightness, and low loss 	● Motor and compressor (for running)
	PMF		-25 °C to +70 °C	0.5 μF to 65 μF [AC] 150 V to 500 V	<ul style="list-style-type: none"> ● High safety (with safety function) ● High reliability, safety standard approval ● Small size, lightness, and low loss 	● Motor and small compressor (for running)
	NRFND SMF		-25 °C to +70 °C	1.5 μF to 9 μF [AC] 370 V to 450 V	<ul style="list-style-type: none"> ● High safety (with safety function) ● High reliability, safety standard approval ● Small size, lightness, and low loss 	● Motor and small compressor (for running)

● **Automotive, Industrial and Infrastructure Use**

Dielectric	Series	Appearance	Operating temp. * *	Rating	Structure·Feature	Application
Metallized polyester Film capacitor for noise suppression of automobile	ECQE		-40 °C to +130 °C	0.47 μF, 2.2 μF, 4.7 μF [DC] 250 V	● Box type	● Noise suppressor for automobile
Metallized polypropylene film capacitors	ECWFG		-40 °C to +110 °C	1.0 μF to 12.0 μF [DC] 600 V to 1100 V	<ul style="list-style-type: none"> ● AEC-Q200 compliant ● High safety (with safety function) ● Excellent moisture resistance ● High thermal shock resistance 	<ul style="list-style-type: none"> ● xEV charging circuit ● AC/DC, AC/DC converter (smoothing, PFC)
Metallized polypropylene film capacitors	NRFND ECQUA		-40 °C to +110 °C	0.1 μF to 10.0 μF [AC] 275 V, 310 V	<ul style="list-style-type: none"> ● AEC-Q200 compliant ● High safety (with safety function) ● Excellent moisture resistance ● High thermal shock resistance ● UL, CSA, ENEC Approved (Class X2) 	<ul style="list-style-type: none"> ● xEV charging circuit ● AC/DC converter (Noise suppression)
DC-Link film capacitor	NRFND Type1		-40 °C to +105 °C	581 μF [DC] 450 V	<ul style="list-style-type: none"> ● High safety, Self-healing and Self-protecting function built in. ● No catastrophic failure upon natural end of life due to inbuilt fuse function. 	● Any automotive and/or other application requiring DC Linkage
Metallized polypropylene film capacitors	EZPE		-40 °C to +85 °C	10 μF to 110 μF [DC] 500 V to 1300 V	<ul style="list-style-type: none"> ● High safety (with safety function) ● Long product life, High reliability ● Low loss, Low ESR ● Flame retardant 	<ul style="list-style-type: none"> ● DC filtering ● DC link circuit
	EZPE (Low profile type)		-40 °C to +85 °C	29 μF : [DC] 450 V 66 μF : [DC] 525 V 12 μF : [DC] 575 V 10 μF : [DC] 630 V	<ul style="list-style-type: none"> ● High safety (with safety function) ● Long product life, High reliability, High moisture resistance ● Low loss, Low ESR ● Flame retardant 	<ul style="list-style-type: none"> ● Solar inverters, Micro inverters ● Wind power generation ● Industrial power supplies ● Inverter circuit in appliances (Air Conditioners etc.)
	★EZPQ		-40 °C to +85 °C	12 μF to 36 μF [AC] 250 V	<ul style="list-style-type: none"> ● High safety (with safety function) ● Long product life, High reliability ● Low loss, Low ESR 	<ul style="list-style-type: none"> ● AC Filter ● Solar inverters ● UPS
			-40 °C to +105 °C	1 μF to 35 μF [AC] 330 V, 380 V, 600 V	<ul style="list-style-type: none"> ● Flame retardant ● High moisture resistance 	<ul style="list-style-type: none"> ● Industrial power supplies ● Inverter circuit in appliances
	EZPV		-40 °C to +105 °C	3 μF to 110 μF [DC] 600 V to 1100 V	<ul style="list-style-type: none"> ● High Safety (with safety function) ● Long product life, High reliability ● Low loss, Low ESR ● Flame retardant (Case and sealing resin) ● AEC-Q200 compliant (For automotive Part No.) 	<ul style="list-style-type: none"> ● For DC filtering ● DC link circuit ● Solar inverters ● Wind power generation ● Industrial power supplies ● Inverter circuit in appliances ● On board charger

* Operating temp. : Including temperature-rise on unit surface.
* Refer to each product page for details.

★Some part number have been designated Not Recommended for New Design.
NRFND Not recommended for new design

Series system diagram

Surface mounting type

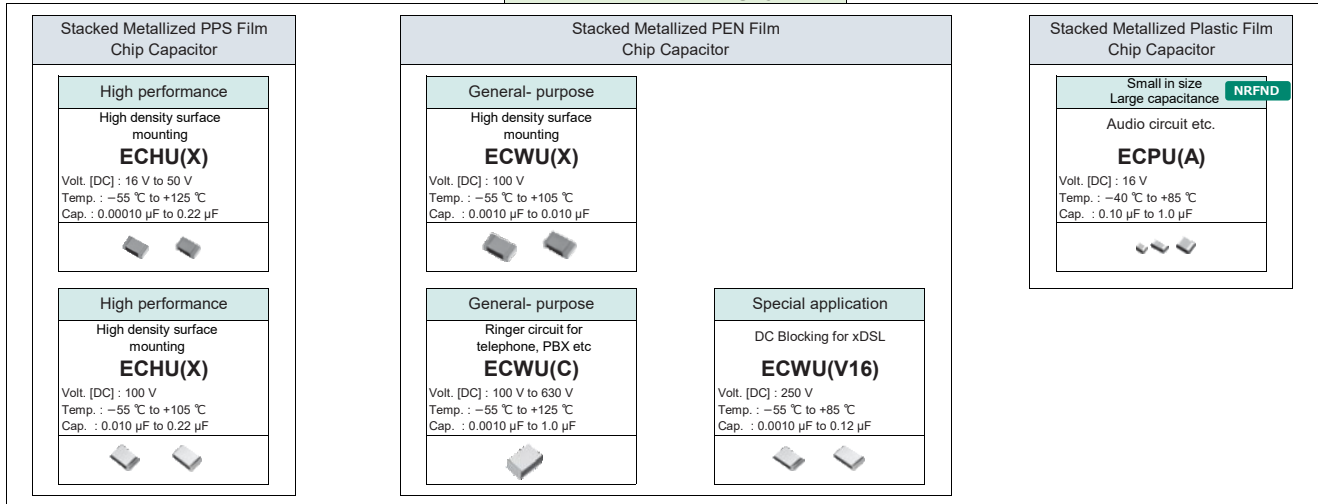

Radial lead type

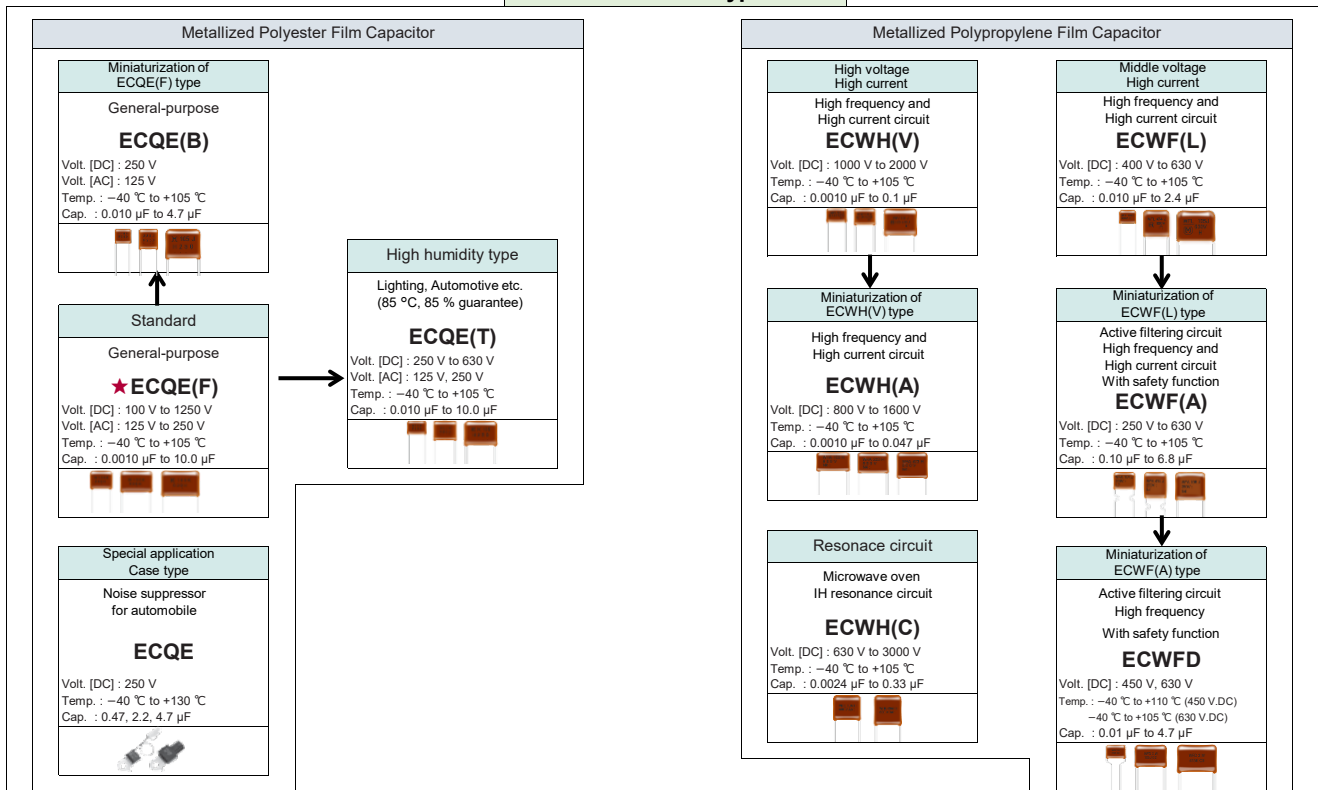

Safety Standard Approval Metallized Film Capacitor

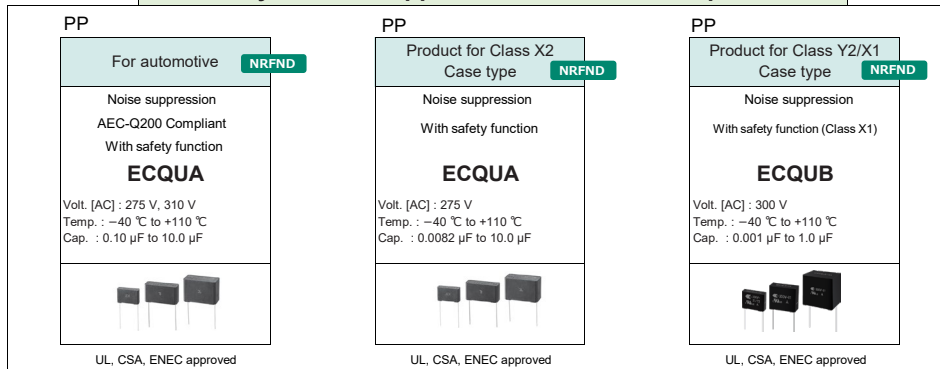

★Some part number have been designated Not Recommended for New Design.
NRFND Not recommended for new design

Main applications & Main products

Switching power supply

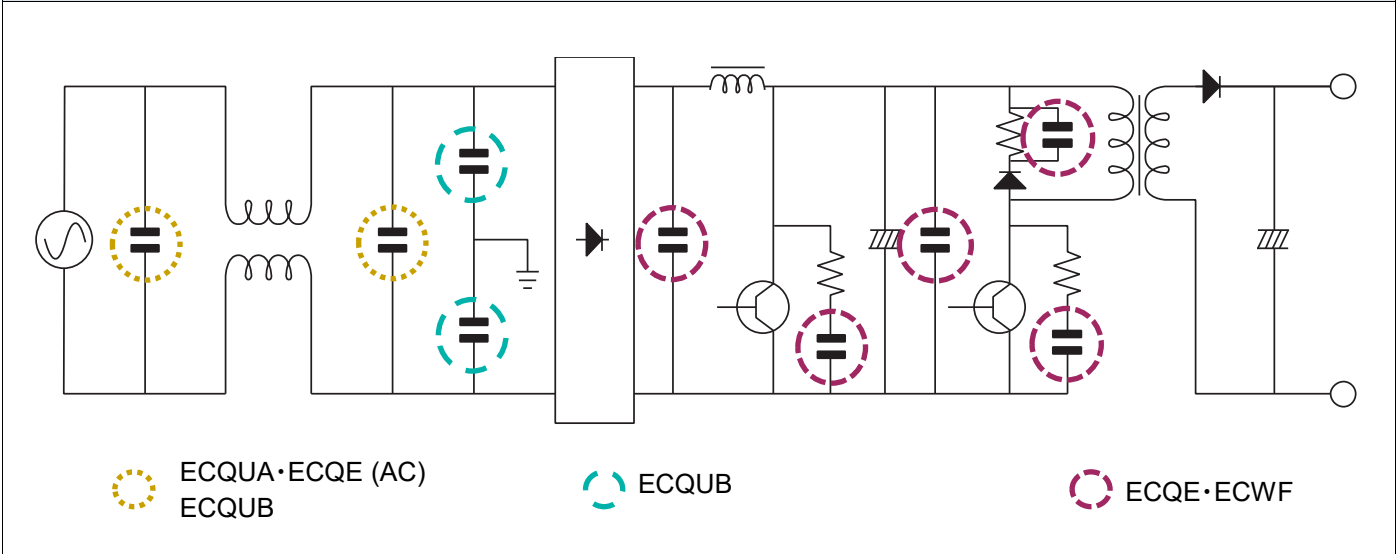

Lighting

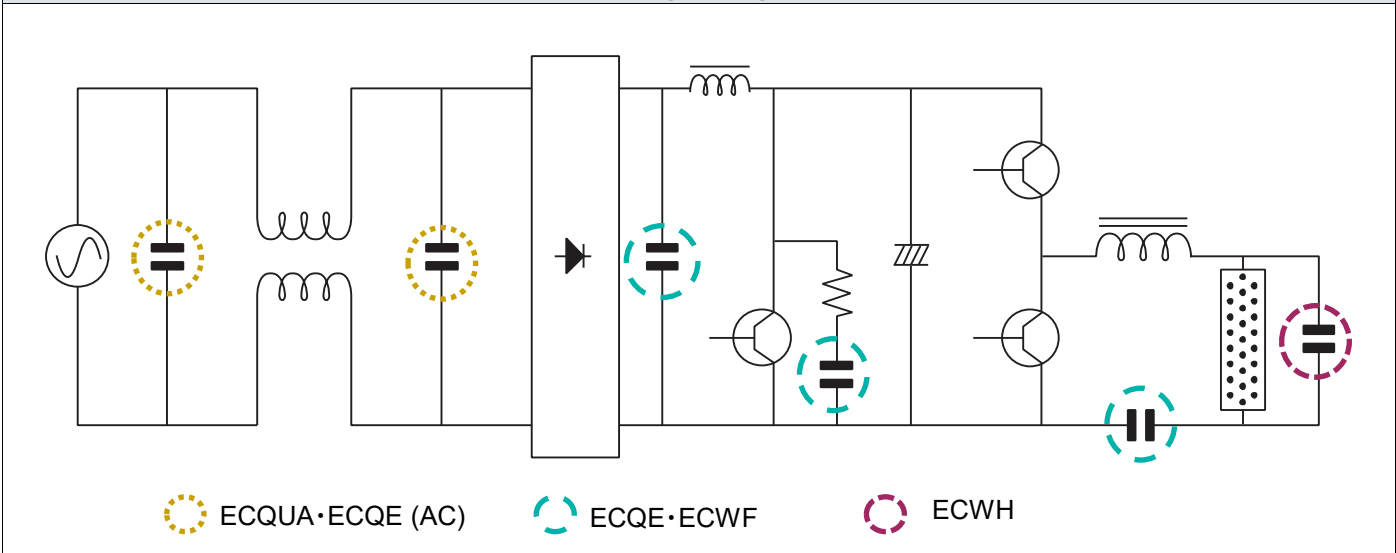

Audio

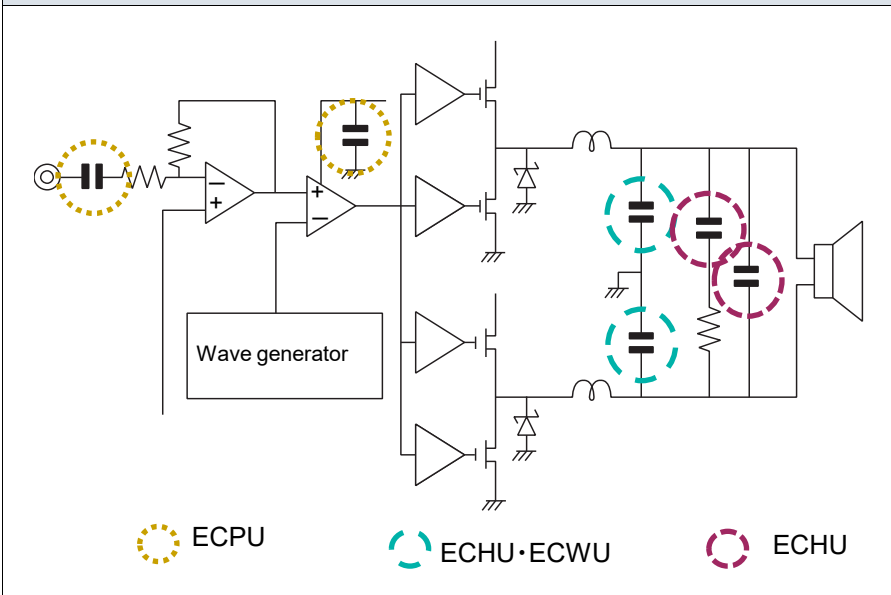

Non-contact charger

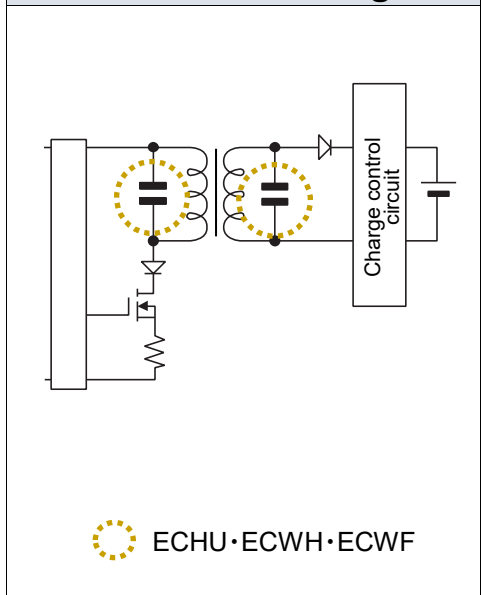

Main applications & Main products

x DSL

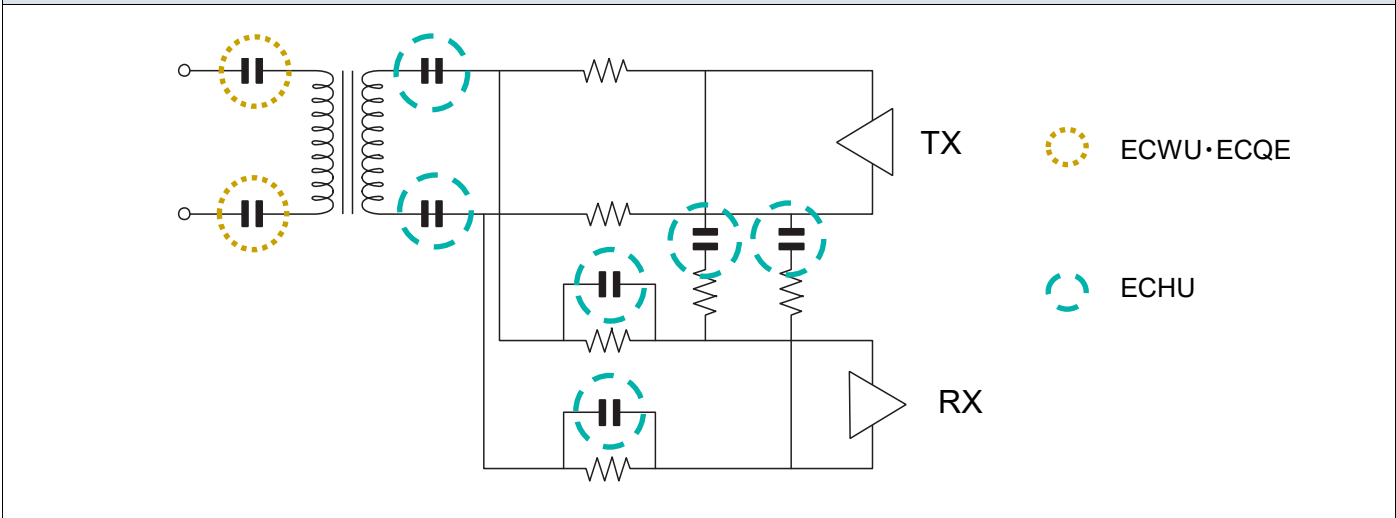

Microwave oven (IH)

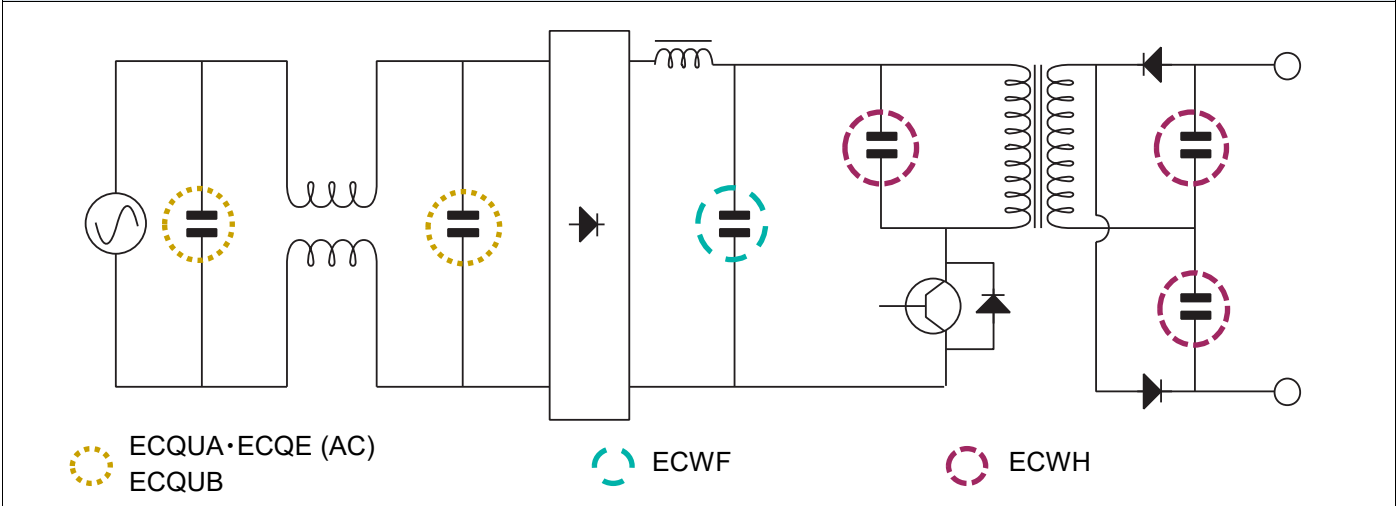

Automobile

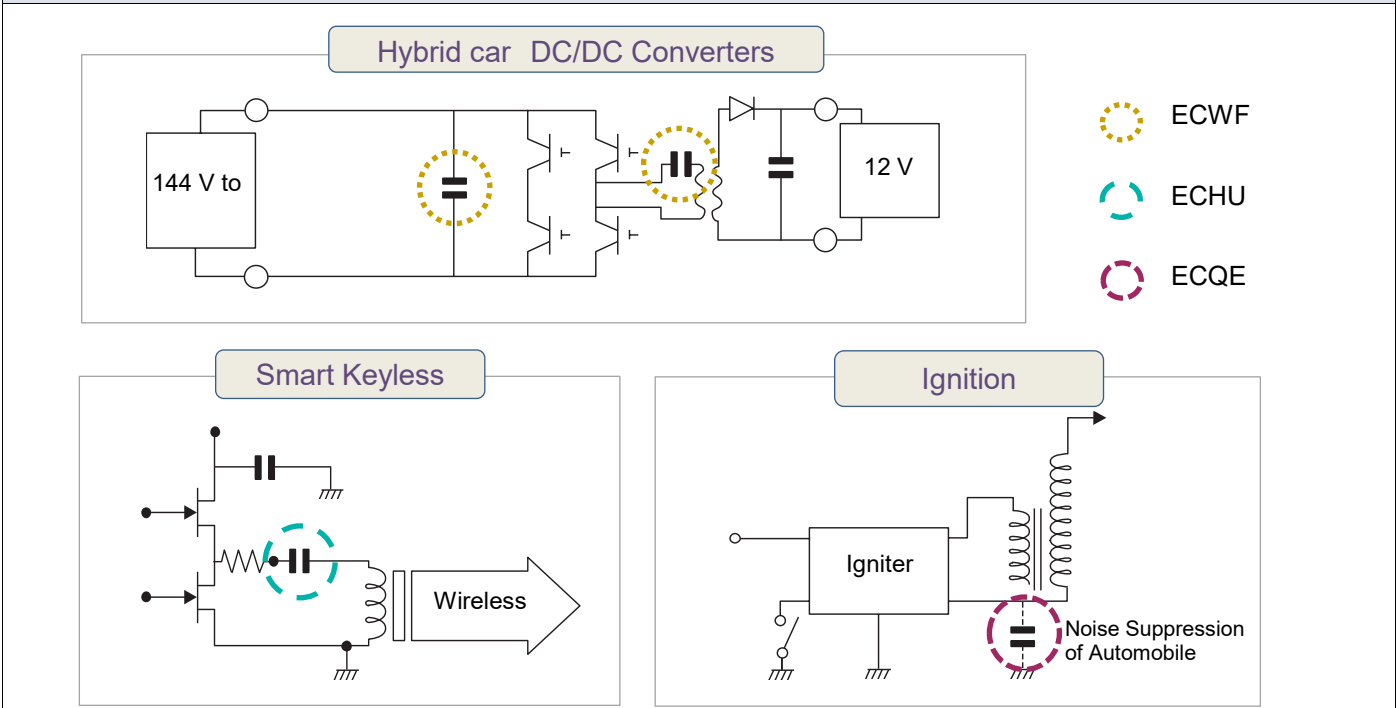

Design and specifications are each subject to change without notice. Ask factory for the current technical specifications before purchase and/or use. Should a safety concern arise regarding this product, please be sure to contact us immediately.

Permissible voltage (R.M.S) in alternating current corresponding to DC rated voltage

1. In case of applying voltage in alternating current (50 Hz or 60 Hz sine wave) to a capacitor, permissible voltage (R.M.S) in alternating current is shown in the following table.
2. Permissible voltage (R.M.S) in alternating current is not an AC rated voltage.
3. The capacitor of DC rating should not be used at the primary side of power supplies.
4. The peak value (zero-to-peak) including pulse of voltage applied capacitor of DC rating should be less than DC rated voltage.
The permissible pulse current is different in each type of the capacitor, please request the product specifications.
5. Please request the product specifications or consult us about details of permissible voltage (R.M.S) in alternating current.

Series		Rated voltage (V) [DC]	Permissible voltage (R.M.S) in alternating current (V) [AC]
ECHU(X)	ECHU1C(X)	16	11
	ECHU1H(X)	50	30
ECHU(C)	ECHU1(C)	100	40
ECWU(X)	ECWU1(X)	100	40
ECWU(C)	ECWU1(C)	100	40
	ECWU2(C)	250	125
	ECWUC2J	630	250
ECPU(A)	ECPU1C(A)	16	12
ECQE(F)	ECQE1(F)	100	63
	ECQE2(F)	250	150
	ECQE4(F)	400	200
	ECQE6(F)	630	250
	ECQE10(F)	1000	400
	ECQE12(F)	1250	500
ECQE(B)	ECQE2(B)	250	125
ECQE(T)	ECQE2(T)	250	150
	ECQE4(T)	400	200
	ECQE6(T)	630	250
ECWF(A)	ECWF2(A)	250	125
	ECWF2W(A)	450	84
	ECWFA2J	630	141
ECWFD	ECWFD2W	450	84
	ECWFD2J	630	141
ECWFE	ECWFE2W	450	84
	ECWFE2J	630	141
ECWFG	ECWFG60	600	50
	ECWFG2J	630	141
	ECWFG70	700	141
	ECWFG80	800	70
	ECWFG1B	1100	90
ECWF(L)	ECWF4(L)	400	141
	ECWF6(L)	630	223
ECWH(A)	ECWH8(A)	800	283
	ECWHA3C	1600	700
ECWH(C)	ECWH6(C)	630	223
	ECWHC3B	1250	450
	ECWHC3F	3000	1060
ECWH(V)	ECWH10(V)	1000	283
	ECWH12(V)	1250	354
	ECWH16(V)	1600	424
	ECWH20(V)	2000	531

Taping type

Shape	Name	Specification	Taping style
Radial type	Standard taping	5 mm lead spacing with 12.7 mm body width	AD, AS, AB
	Odd size taping (I)	5, 7.5 mm lead spacing with 15 mm & up body width	B, C, D, E, F
	Odd size taping (II)	Other than above	Please consult
Chip type	Embossed taping	Apply for chip type	carrier tape : 8, 12, 16, 24 mm

Radial type taping

● Standard taping

Unit : mm

	Style AD	Style AS	Style AB
P	12.7	12.7	12.7
P ₀	12.7	12.7	12.7
F	5.0	5.0	5.0
H ₀	16.0	(H)18.0-20.0	16.0
H ₁	34.0 max.	34.0 max.	34.0 max.

Note : H₁ dimension is based on insertion machine "Panassert RH series" made by Panasonic.
Consult with Panasonic technical staff when using other insertion machines.

● Odd size taping (I)

Unit : mm

	Style B	Style C	Style D
P	15.0	25.4	15.0
P ₀	15.0	12.7	15.0
F	5.0	5.0	7.5
H ₀	16.0	16.0	16.0
H ₁	39.0 max.	39.0 max.	44.0 max.

	Style E	Style F
P	30.0	15.0
P ₀	15.0	15.0
F	7.5	7.5
H ₀	16.0	16.0
H ₁	44.0 max.	44.0 max.

Note : H₁ dimension is based on insertion machine "Panassert RH series" made by Panasonic.
Consult with Panasonic technical staff when using other insertion machines.

● Odd size taping (II)

If the specification of taping is changed by various conditions, including, dimensions, lead spacing and insertion machine, please contact the nearest sales office for further information.

Dimensions

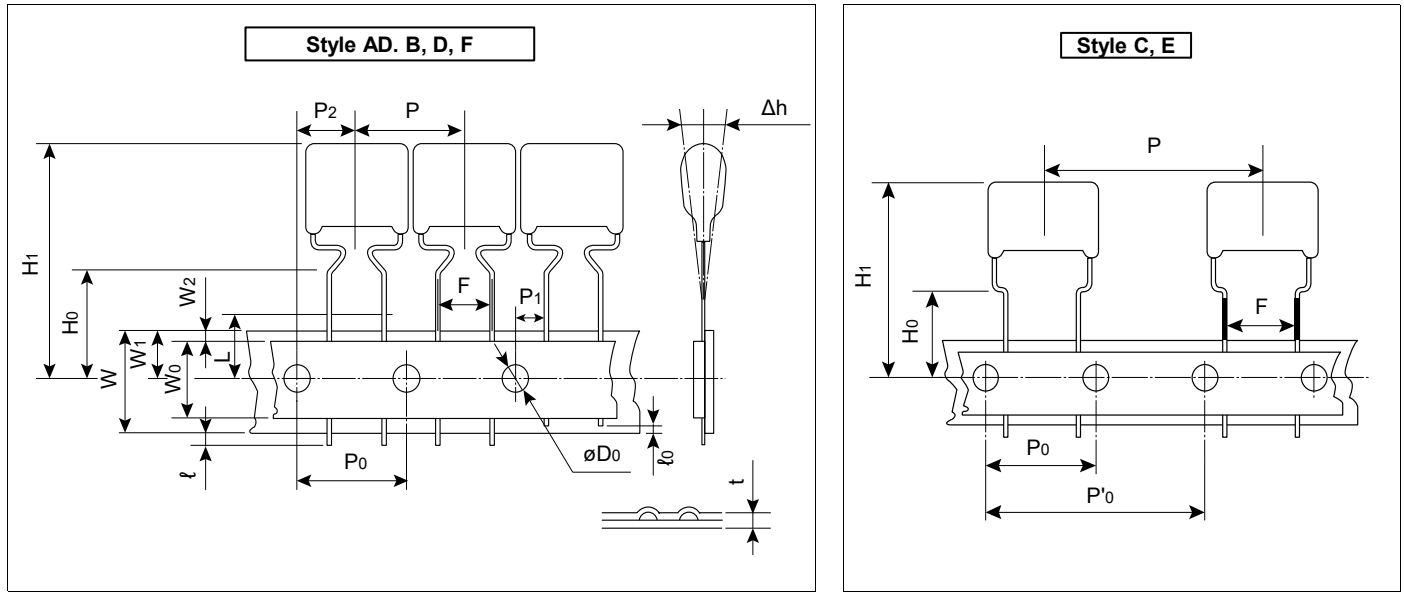

Unit : mm

Code	Style AB, AD, AS	Style B	Style C	Style D, F	Style E
P	12.7±1.0	15.0±1.0	25.4±1.0	15.0±1.0	30.0±1.0
P ₀	12.7±0.2	15.0±0.2	12.7±0.2	15.0±0.2	15.0±0.2
P' ₀	—	—	25.4±0.2	—	30.0±0.2
P ₁	3.85±0.50	5.0±0.5	3.85±0.50	3.75±0.50	3.75±0.50
P ₂	6.35±1.30	7.5±1.3	6.35±1.30	7.5±1.3	7.5±1.3
F	5.0 ^{+0.8} _{-0.2}	5.0 ^{+0.8} _{-0.2}	5.0 ^{+0.8} _{-0.2}	7.5 ^{+0.8} _{-0.2}	7.5 ^{+0.8} _{-0.2}
Δh	0±2.0				
W	18.0±0.5				
W ₀	9.5 min.				
W ₁	9.0±0.5				
W ₂	0-3.0				
H ₀	16.0±0.5*	16.0±0.5	16.0±0.5	16.0 ^{+1.0} ₀	16.0 ^{+1.0} ₀
H ₁	34.0 max.	39.0 max.	39.0 max.	44.0 max.	44.0 max.
ℓ	0				
ℓ ₀	7.0 max.				
øD ₀	4.0±0.2				
t	0.7±0.2				
L	11.0 max.				

* Style AS is 18.0 – 20.0 in code H.

Note : H₁ dimension is based on insertion machine "Panaset RH series" made by Panasonic.

Consult with Panasonic technical staff when using other insertion machines.

Packing

● Ammo Packing

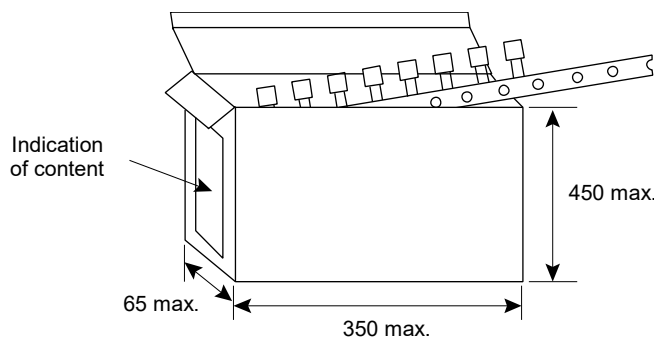

Unit : mm

Ammo Box depends on capacitor's dimensions, taping style and quantity.

Chip type embossed tapping

● Embossed tapping

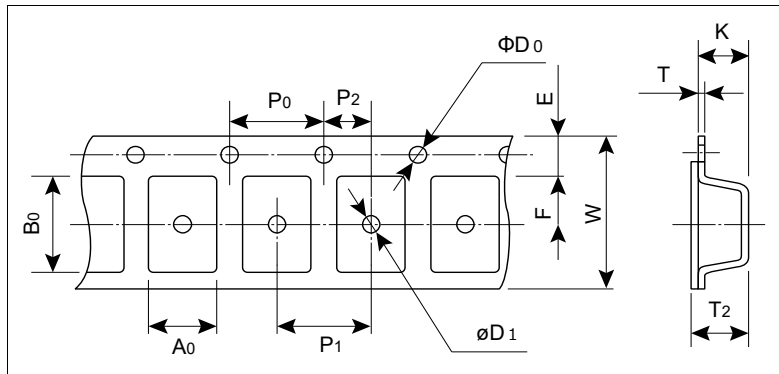

● Standard packaging quantities

Size code	Reel	Quantity
K1	ø180	4000 pcs/reel
J1, J2, H1, H2	ø180	3000 pcs/reel
H3, G1, G2, G3	ø180	2000 pcs/reel
E1, E2, D1, D2	ø330	3000 pcs/reel
E3a, E3, D3, D4, D5	ø330	2000 pcs/reel
B, Z	ø330	1500 pcs/reel
X, Y, V	ø330	1000 pcs/reel

Size code	Dimensions (mm)												
	A ₀ ±0.10	B ₀ ±0.10	W±0.3	F±0.05	E±0.10	P ₁ ±0.1	P ₂ ±0.05	P ₀ ±0.1	øD ₀ ^{+0.1} ₀	øD ₁ ^{+0.2} ₀	T±0.05	T ₂ ±0.2	K±0.1
K1	1.00	1.85	8.0	3.50	1.75	-	2.00	4.0	1.5	1.0	0.20	1.0	0.9
J1	1.55	2.30				1.2							
J2	1.55	2.30				1.4							
H1, H2	1.90	3.50				1.4							
H3	1.90	3.50				1.8							
G1, G2	2.80	3.50				1.8							
G3	2.80	3.50				2.4							
E1	3.80	5.10	12.0	5.50	1.75	8.0	2.00	4.0	1.5	1.5	0.30	1.0	1.9
E2	3.80	5.10											2.5
E3a, E3	3.80	5.10											2.6
D1, D2	4.60	6.30											3.3
D3, D4	4.60	6.30											2.7
D5	4.60	6.30											2.6
B	5.50	6.30											3.5
Z	5.50	7.50	3.4										
			4.6										
			5.1										
			4.5										
			5.0										
			4.7										
			4.6										

Size code	Dimensions (mm)												
	A ₀ ±0.1	B ₀ ±0.1	W ^{+0.3} _{-0.1}	F±0.1	E±0.10	P ₁ ±0.1	P ₂ ±0.1	P ₀ ±0.1	øD ₀ ^{+0.10} ₀	øD ₁ ^{+0.25} ₀	T±0.02	T ₂ ±0.2	K±0.1
X, Y	6.9	8.4	16.0	7.5	1.75	12.0	2.0	4.0	1.50	1.50	0.34	1.0	5.7
V	8.9	10.5											5.8

● Reel dimensions

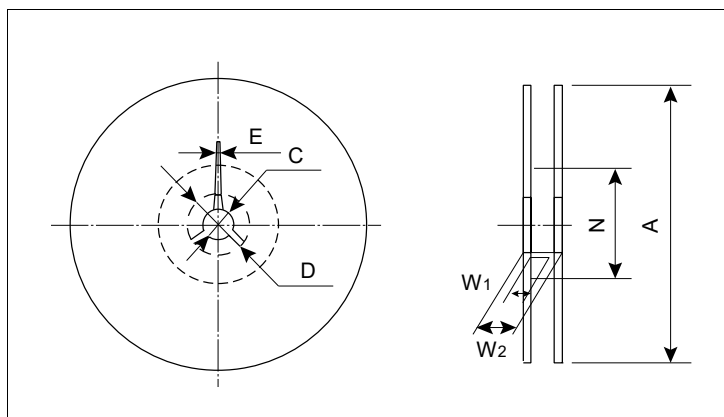

● Leader part and tape end

Unit : mm

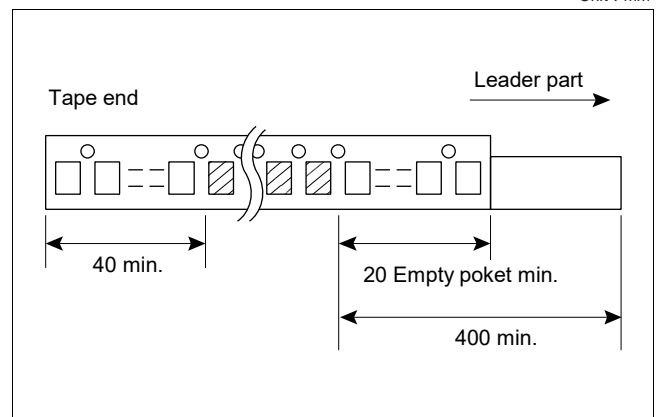

Size code	Dimensions (mm)			
	Reel size ø180		Reel size ø330	
	Tape width 8		Tape width 12	Tape width 16
A	180.0 ⁰ _{-1.5}		330.0±2.0	
C	13.0±0.2		13.0±0.2	
D	21.0±0.8		21.0±0.8	
E	2.0±0.5		2.0±0.5	
N	60.0 ^{+1.0} ₀		80.0±1.0	
W ₁	9.0 ^{+1.0} ₀		13.4±1.0	17.4±1.0
W ₂	11.4±1.0		17.4±1.0	21.4±1.0

Design and specifications are each subject to change without notice. Ask factory for the current technical specifications before purchase and/or use. Should a safety concern arise regarding this product, please be sure to contact us immediately.

Temperature characteristics

Typical curve

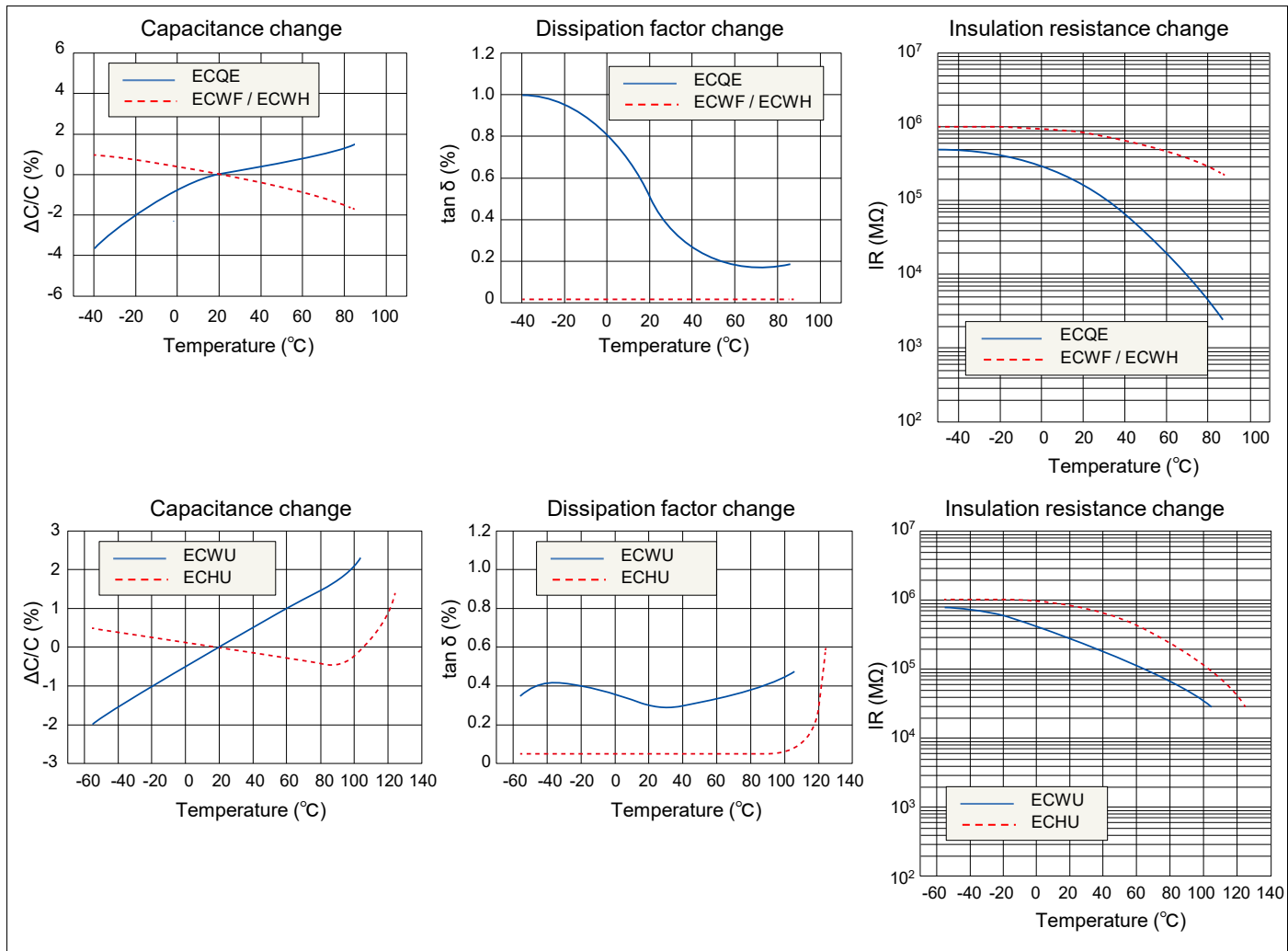

Frequency characteristics

Typical curve

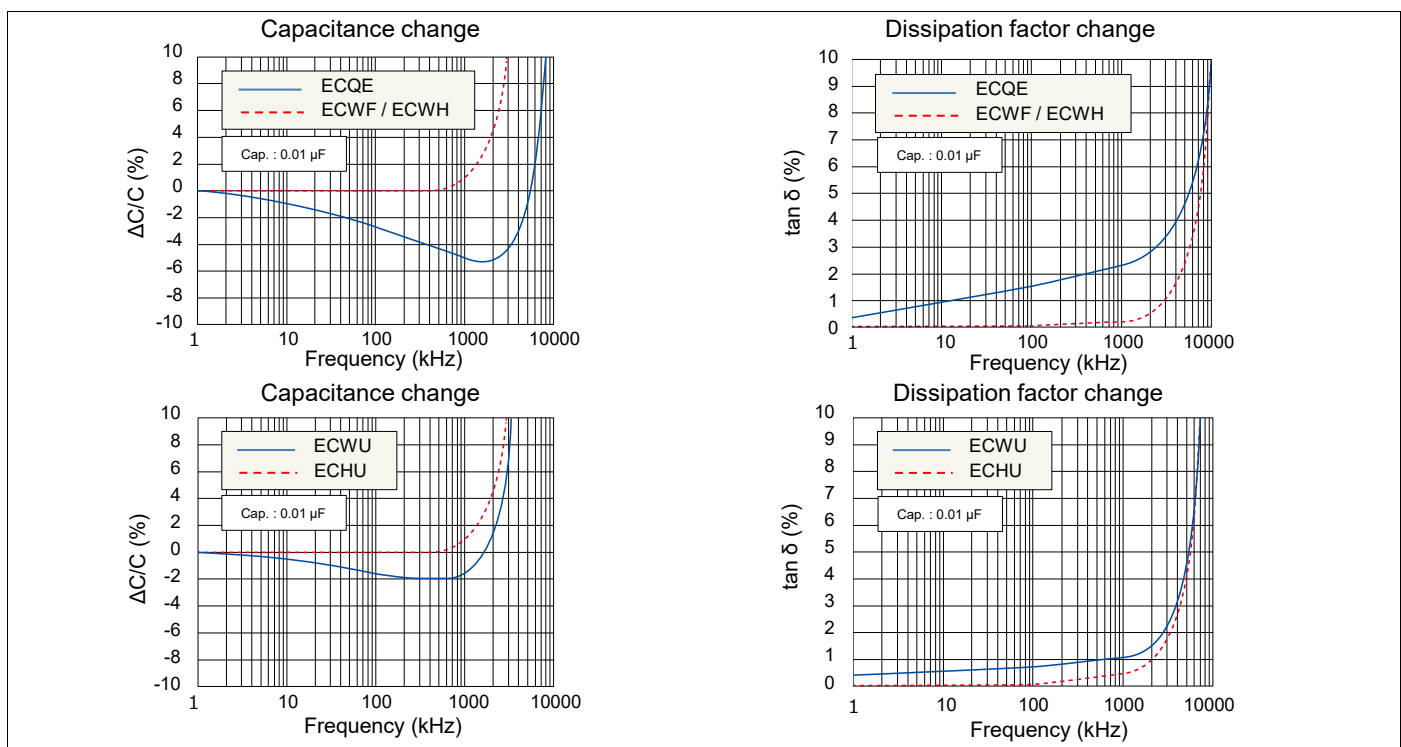

Design and specifications are each subject to change without notice. Ask factory for the current technical specifications before purchase and/or use. Should a safety concern arise regarding this product, please be sure to contact us immediately.

Product system for film chip capacitor

Dielectric	PPS						PEN										Thermoset resin		
	ECHU(X)			ECHU(C)			ECWU(C)					ECWU(V16)		ECWU(X)			ECPU(A)		
Rated. volt [DC]	16 V		50 V*		100 V		100 V*		250 V*		630 V*		250 V		100 V			16 V	
Category temp. range	-55 °C to +125 °C			-55 °C to +105 °C			-55 °C to +125 °C					-55 °C to +85 °C		-55 °C to +105 °C			-40 °C to +85 °C		
Capacitance tol.	±2 %, ±5 %						±5 %, ±10 %					±5 %		±5 %			±20 %		
Soldering	Reflow						Reflow										Reflow		
Capacitance	Size code	H	Size code	H	Size code	H	Size code	H	Size code	H	Size code	H	Size code	H	Size code	H	Size code	H	
0.00010	1608	0.7	2012	0.9															
0.00012	1608	0.7	2012	0.9															
0.00015	1608	0.7	2012	0.9															
0.00018	1608	0.7	2012	0.9															
0.00022	1608	0.7	2012	0.9															
0.00027	1608	0.7	2012	0.9															
0.00033	1608	0.7	2012	0.9															
0.00039	1608	0.7	2012	0.9															
0.00047	1608	0.7	2012	0.9															
0.00056	1608	0.7	2012	0.9															
0.00068	1608	0.7	2012	0.9															
0.00082	1608	0.7	2012	0.9															
0.0010	1608	0.7	2012	0.9					4833	1.4			4833	1.4	3216	1.1			
0.0012	1608	0.7	2012	0.9					4833	1.4			4833	1.4	3216	1.1			
0.0015	1608	0.7	2012	0.9					4833	1.4			4833	1.4	3216	1.1			
0.0018	1608	0.7	2012	0.9					4833	1.4			4833	1.4	3216	1.1			
0.0022	1608	0.7	2012	0.9					4833	1.4			4833	1.4	3216	1.1			
0.0027	1608	0.7	2012	0.9					4833	1.4			4833	1.4	3216	1.1			
0.0033	2012	0.9	3216	0.9					4833	1.4			4833	1.4	3216	1.5			
0.0039	2012	0.9	3216	0.9					4833	1.4			4833	1.4	3216	1.5			
0.0047	2012	0.9	3216	0.9					4833	1.4			4833	1.4	3216	1.5			
0.0056	2012	0.9	3216	0.9					4833	1.4			4833	1.4	3225	1.5			
0.0068	2012	0.9	3216	0.9					4833	1.4			4833	1.4	3225	1.5			
0.0082	2012	1.1	3216	1.1					4833	1.4			4833	1.4	3225	2.1			
0.010	2012	1.1	3216	1.1	4833	1.4			4833	1.4			4833	1.4	3225	2.1			
0.012	3216	0.9	3225	1.1	4833	1.4	4833	1.4	4833	1.4			4833	1.4					
0.015	3216	0.9	3225	1.1	4833	2.0	4833	1.4	4833	1.4			4833	1.4					
0.018	3216	0.9	3225	1.5	4833	2.0	4833	1.4	4833	2.0			4833	2.0					
0.022	3216	0.9	3225	1.5	4833	2.4	4833	1.4	4833	2.0	7163	3.6	4833	2.0					
0.027	3216	1.1	3225	1.5	4833	2.8	4833	1.4	4833	2.4	7163	4.1	4833	2.4					
0.033	3216	1.1	3225	2.1	6041	1.8	4833	1.4	4833	2.8	7163	5.1	4833	2.8					
0.039	3216	1.5	3225	2.1	6041	2.0	4833	1.4	6041	2.0			6041	2.0					
0.047	3216	1.5	4833	1.5	6041	2.4	4833	2.0	6041	2.4			6041	2.4					
0.056	3225	1.5	4833	1.5	6041	2.8	4833	2.0	6041	2.8			6041	2.8					
0.068	3225	1.5	4833	1.5	6041	3.2	4833	2.4	6041	3.2			6041	3.2					
0.082	3225	2.1	4833	2.1	7150	2.8	4833	2.8	6050	3.2			6050	3.2					
0.10	3225	2.1	4833	2.1	7150	3.0	6041	1.8	6050	3.8			6050	3.8			2012	1.0	
0.12			6041	1.9	7150	3.4	6041	2.4	6050	4.5			6050	4.5					
0.15			6041	1.9	7163	3.4	6041	2.8									3216	0.8	
0.18			6041	2.5	7163	4.0	7150	2.0											
0.22			6041	2.8	7163	4.8	7150	2.4									3216	0.8	
0.27							7150	2.9											
0.33							7150	3.5									3216	1.0	
0.39							7755	3.4											
0.47							7755	4.0									3216	1.4	
0.56							9863	3.0											
0.68							9863	3.6									3216	1.4	
0.82							9863	4.3											
1.0							9863	5.1									3225	1.4	

* Please confirm in the individual page because the specifications depend on the partial capacitance. Unit : mm

Plastic Film Capacitors

Stacked Metallized PPS Film Chip Capacitor

ECHU(X) series

Stacked metallized PPS film as dielectric with simple mold-less construction.

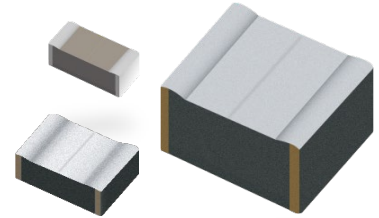

Features

- Small in size (Minimum size 1.6 mm × 0.8 mm)
- 85 °C, 85 %RH, W.V. × 1.0 for 500 hours
- For reflow soldering
- RoHS compliant

Recommended applications

- Time-constant
- Filtering
- Oscillation and resonance
- Audio circuit

Explanation of part number

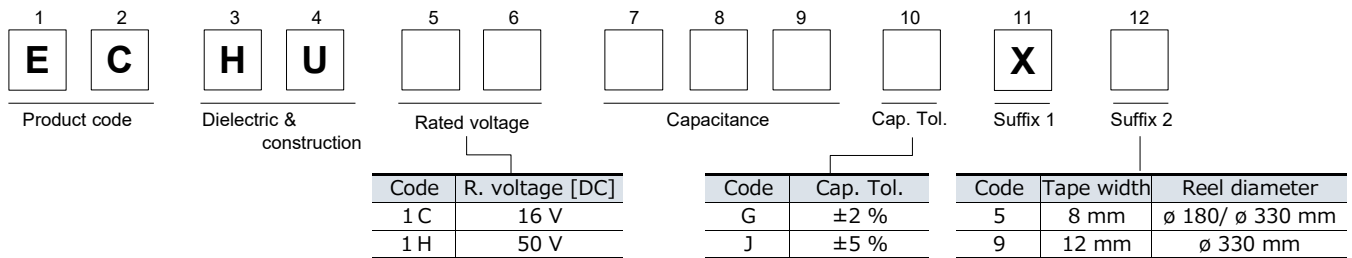

Specifications

Category temp. range (Including temperature-rise on unit surface)	-55 °C to +125 °C
Rated voltage [DC]	16 V, 50 V (50 V [DC] : 0.12 µF or more : Derating or rated voltage by 1.25 % / °C at more than 105 °C)
Capacitance range	16 V : 0.00010 µF to 0.10 µF (E12) 50 V : 0.00010 µF to 0.22 µF (E12)
Capacitance tolerance	±2 % (G), ±5 % (J)
Dissipation factor (tan δ)	tan δ ≤ 0.6 % (20 °C, 1 kHz)
Withstand voltage	Between terminals : Rated voltage (V) × 150 % 60 s
Insulation resistance (IR)	16 V : IR ≥ 3000 MΩ (20 °C, 10 V, 60 s) 50 V : IR ≥ 3000 MΩ (20 °C, 50 V, 60 s)
Soldering conditions	Reflow soldering : 260 °C max. and 95 sec max. at more than 220 °C (Temp. at capacitor surface)

* Please consult us for flow soldering.

* In case of applying voltage in alternating current (50 Hz or 60 Hz sine wave) to a capacitor with DC rated voltage, please refer to the page of "Permissible voltage (R.M.S) in alternating current corresponding to DC rated voltage".

Construction

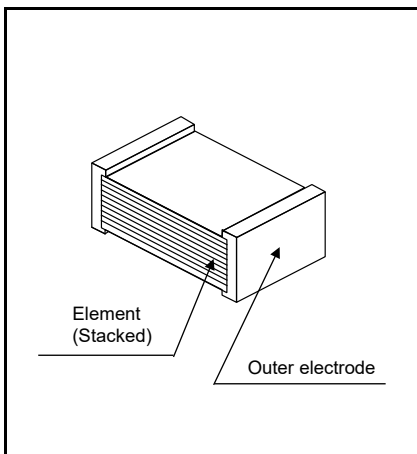

Dimensions

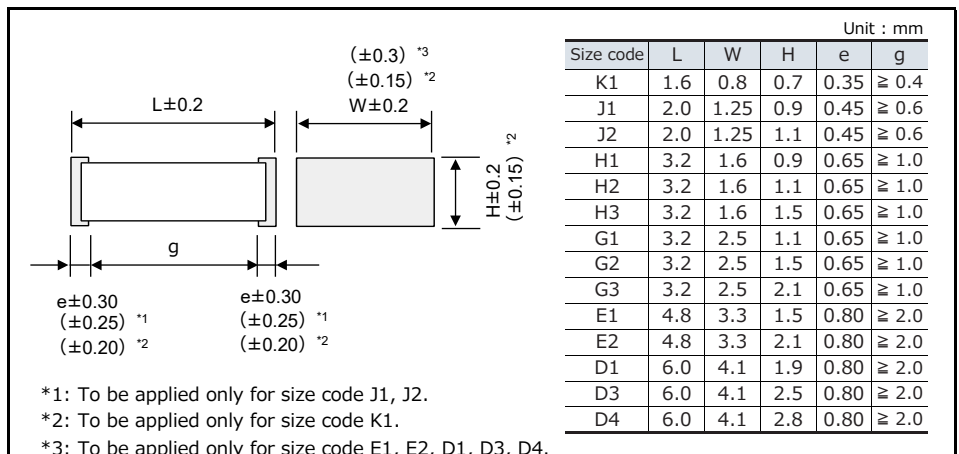

Taping specification for automatic mounting

■ Refer to the page of taping specifications

Rating · Dimensions · Quantity

■ Capacitance tolerance : ±2 %(G), ±5 %(J)

Capacitance (μF)	Rated voltage 16 V					Rated voltage 50 V								
	Part No.	Dimensions (mm)			Size code	Q'ty (PCS)	Part No.	Dimensions (mm)			Size code	Q'ty (PCS)		
		L	W	H				L	W	H				
0.00010	ECHU1C101□X5	1.6	0.8	0.7	K1	4000	ECHU1H101□X5	2.0	1.25	0.9	J1	3000		
0.00012	ECHU1C121□X5	1.6	0.8	0.7	K1		ECHU1H121□X5	2.0	1.25	0.9	J1			
0.00015	ECHU1C151□X5	1.6	0.8	0.7	K1		ECHU1H151□X5	2.0	1.25	0.9	J1			
0.00018	ECHU1C181□X5	1.6	0.8	0.7	K1		ECHU1H181□X5	2.0	1.25	0.9	J1			
0.00022	ECHU1C221□X5	1.6	0.8	0.7	K1		ECHU1H221□X5	2.0	1.25	0.9	J1			
0.00027	ECHU1C271□X5	1.6	0.8	0.7	K1		ECHU1H271□X5	2.0	1.25	0.9	J1			
0.00033	ECHU1C331□X5	1.6	0.8	0.7	K1		ECHU1H331□X5	2.0	1.25	0.9	J1			
0.00039	ECHU1C391□X5	1.6	0.8	0.7	K1		ECHU1H391□X5	2.0	1.25	0.9	J1			
0.00047	ECHU1C471□X5	1.6	0.8	0.7	K1		ECHU1H471□X5	2.0	1.25	0.9	J1			
0.00056	ECHU1C561□X5	1.6	0.8	0.7	K1		ECHU1H561□X5	2.0	1.25	0.9	J1			
0.00068	ECHU1C681□X5	1.6	0.8	0.7	K1		ECHU1H681□X5	2.0	1.25	0.9	J1			
0.00082	ECHU1C821□X5	1.6	0.8	0.7	K1		ECHU1H821□X5	2.0	1.25	0.9	J1			
0.0010	ECHU1C102□X5	1.6	0.8	0.7	K1		ECHU1H102□X5	2.0	1.25	0.9	J1			
0.0012	ECHU1C122□X5	1.6	0.8	0.7	K1		ECHU1H122□X5	2.0	1.25	0.9	J1			
0.0015	ECHU1C152□X5	1.6	0.8	0.7	K1		ECHU1H152□X5	2.0	1.25	0.9	J1			
0.0018	ECHU1C182□X5	1.6	0.8	0.7	K1		ECHU1H182□X5	2.0	1.25	0.9	J1			
0.0022	ECHU1C222□X5	1.6	0.8	0.7	K1	ECHU1H222□X5	2.0	1.25	0.9	J1				
0.0027	ECHU1C272□X5	1.6	0.8	0.7	K1	ECHU1H272□X5	2.0	1.25	0.9	J1				
0.0033	ECHU1C332□X5	2.0	1.25	0.9	J1	3000	ECHU1H332□X5	3.2	1.6	0.9	H1	2000		
0.0039	ECHU1C392□X5	2.0	1.25	0.9	J1		ECHU1H392□X5	3.2	1.6	0.9	H1			
0.0047	ECHU1C472□X5	2.0	1.25	0.9	J1		ECHU1H472□X5	3.2	1.6	0.9	H1			
0.0056	ECHU1C562□X5	2.0	1.25	0.9	J1		ECHU1H562□X5	3.2	1.6	0.9	H1			
0.0068	ECHU1C682□X5	2.0	1.25	0.9	J1		ECHU1H682□X5	3.2	1.6	0.9	H1			
0.0082	ECHU1C822□X5	2.0	1.25	1.1	J2		ECHU1H822□X5	3.2	1.6	1.1	H2			
0.010	ECHU1C103□X5	2.0	1.25	1.1	J2		ECHU1H103□X5	3.2	1.6	1.1	H2			
0.012	ECHU1C123□X5	3.2	1.6	0.9	H1		ECHU1H123□X5	3.2	2.5	1.1	G1			
0.015	ECHU1C153□X5	3.2	1.6	0.9	H1		ECHU1H153□X5	3.2	2.5	1.1	G1			
0.018	ECHU1C183□X5	3.2	1.6	0.9	H1		ECHU1H183□X5	3.2	2.5	1.5	G2			
0.022	ECHU1C223□X5	3.2	1.6	0.9	H1		ECHU1H223□X5	3.2	2.5	1.5	G2			
0.027	ECHU1C273□X5	3.2	1.6	1.1	H2		ECHU1H273□X5	3.2	2.5	1.5	G2			
0.033	ECHU1C333□X5	3.2	1.6	1.1	H2		2000	ECHU1H333□X5	3.2	2.5	2.1		G3	3000
0.039	ECHU1C393□X5	3.2	1.6	1.5	H3			ECHU1H393□X5	3.2	2.5	2.1		G3	
0.047	ECHU1C473□X5	3.2	1.6	1.5	H3			ECHU1H473□X9	4.8	3.3	1.5		E1	
0.056	ECHU1C563□X5	3.2	2.5	1.5	G2			ECHU1H563□X9	4.8	3.3	1.5		E1	
0.068	ECHU1C683□X5	3.2	2.5	1.5	G2	2000	ECHU1H683□X9	4.8	3.3	1.5	E1	3000		
0.082	ECHU1C823□X5	3.2	2.5	2.1	G3		ECHU1H823□X9	4.8	3.3	2.1	E2			
0.10	ECHU1C104□X5	3.2	2.5	2.1	G3		ECHU1H104□X9	4.8	3.3	2.1	E2			
0.12							ECHU1H124□X9	6.0	4.1	1.9	D1			
0.15						ECHU1H154□X9	6.0	4.1	1.9	D1				
0.18						ECHU1H184□X9	6.0	4.1	2.5	D3				
0.22						ECHU1H224□X9	6.0	4.1	2.8	D4				

* □ : Capacitance tolerance code

Recommended for land dimensions

The diagram shows a top-down view of a capacitor with two electrodes. The distance between the inner edges of the electrodes is labeled 'Land'. The distance between the outer edges of the electrodes is labeled 'A'. The distance between the centerlines of the electrodes is labeled 'B'. The height of the capacitor is labeled 'C'. An arrow points to one of the electrodes.

Unit : mm

Size code	Land dimensions		
	Reflow soldering		
	A	B	C
K1	0.6	2.0	0.7
J1, J2	0.8	2.4	1.1
H1, H2, H3	1.8	3.6	1.4
G1, G2, G3	1.8	3.6	2.3
E1, E2	3.0	5.6	3.0
D1, D3, D4	4.0	7.0	3.8

* It is not warrantable that you can mount the capacitor without trouble under all the mounting condition when "Recommender for Land dimensions" is adopted.

Plastic Film Capacitors

Stacked Metallized PPS Film Chip Capacitor

ECHU(C) series

Stacked metallized PPS film as dielectric with simple mold-less construction.

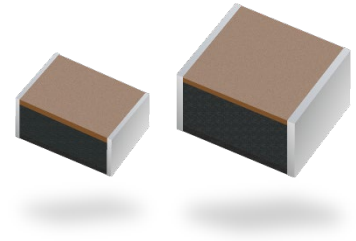

Features

- Small in size
- Low loss and excellent frequency characteristics
- For reflow soldering
- RoHS compliant

Recommended applications

- Time-constant
- Filtering
- Oscillation and resonance
- Resonance circuit for LCD backlight inverter unit

Explanation of part number

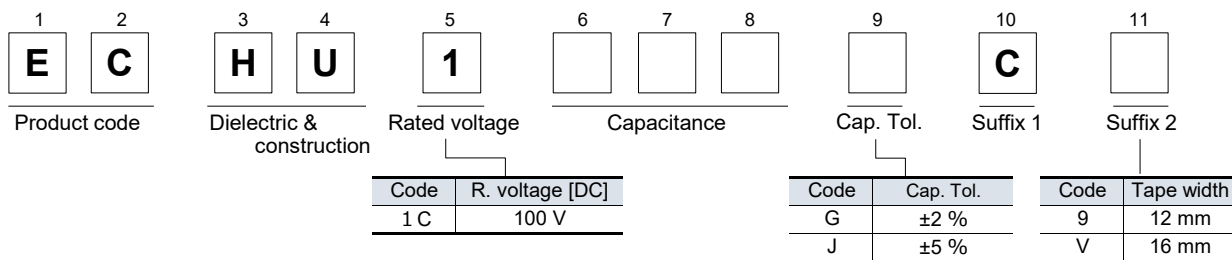

Specifications

Category temp. range (Including temperature-rise on unit surface)	-55 °C to +105 °C
Rated voltage [DC]	100 V
Capacitance range	0.010 μF to 0.22 μF (E12)
Capacitance tolerance	±2 % (G), ±5 % (J)
Dissipation factor (tan δ)	tan δ ≤ 0.6 % (20 °C, 1 kHz)
Withstand voltage	Between terminals : Rated voltage (V) × 150 % 60 s
Insulation resistance (IR)	IR ≥ 3000 MΩ (20 °C, 10 V, 60 s)
Soldering conditions	Reflow soldering : 260 °C max. and 95 sec max. at more than 220 °C (Temp. at capacitor surface)

* In case of applying voltage in alternating current (50 Hz or 60 Hz sine wave) to a capacitor with DC rated voltage, please refer to the page of "Permissible voltage (R.M.S) in alternating current corresponding to DC rated voltage".

Construction

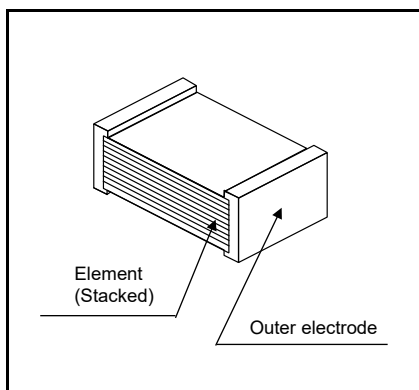

Dimensions

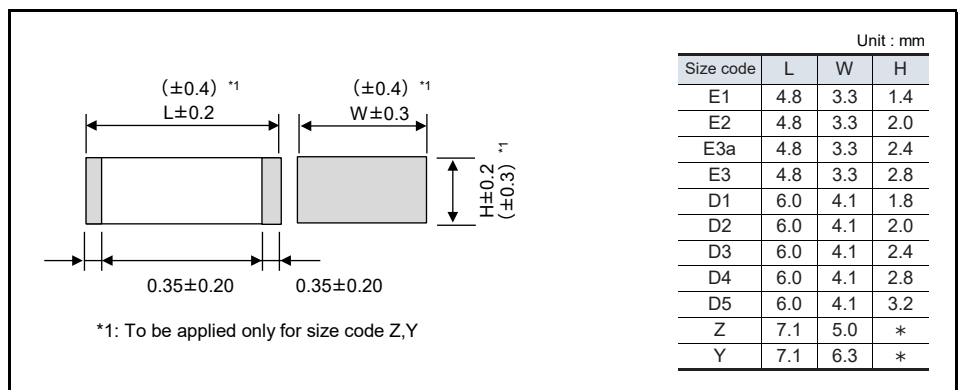

Taping specification for automatic mounting

■ Refer to the page of taping specifications

Rating · Dimensions · Quantity

■ Capacitance tolerance : $\pm 2\%$ (G), $\pm 5\%$ (J)

Capacitance (μF)	Part No.	Rated voltage 100 V				Size code	Q'ty (PCS)
		Dimensions (mm)					
		L	W	H			
0.010	ECHU1103□C9	4.8	3.3	1.4	E1	3000	
0.012	ECHU1123□C9	4.8	3.3	1.4	E1		
0.015	ECHU1153□C9	4.8	3.3	2.0	E2		
0.018	ECHU1183□C9	4.8	3.3	2.0	E2		
0.022	ECHU1223□C9	4.8	3.3	2.4	E3a	2000	
0.027	ECHU1273□C9	4.8	3.3	2.8	E3		
0.033	ECHU1333□C9	6.0	4.1	1.8	D1	3000	
0.039	ECHU1393□C9	6.0	4.1	2.0	D2		
0.047	ECHU1473□C9	6.0	4.1	2.4	D3	2000	
0.056	ECHU1563□C9	6.0	4.1	2.8	D4		
0.068	ECHU1683□C9	6.0	4.1	3.2	D5		
0.082	ECHU1823□C9	7.1	5.0	2.8	Z	1500	
0.10	ECHU1104□C9	7.1	5.0	3.0	Z		
0.12	ECHU1124□C9	7.1	5.0	3.4	Z		
0.15	ECHU1154□CV	7.1	6.3	3.4	Y	1000	
0.18	ECHU1184□CV	7.1	6.3	4.0	Y		
0.22	ECHU1224□CV	7.1	6.3	4.8	Y		

* □ : Capacitance tolerance code

Recommended for land dimensions

The diagram illustrates the recommended land dimensions for automatic mounting. It shows two vertical electrodes with a central land. Dimension A is the width of the land, B is the total width including both electrodes, and C is the height of the electrodes. The word 'Electrode' is labeled with an arrow pointing to one of the vertical bars.

Unit : mm

Size code	Land dimensions		
	Reflow soldering		
	A	B	C
E1, E2, E3a, E3	2.6	6.6	3.0
D1, D2, D3, D4, D5	3.8	7.8	3.8
Z	4.5	9.0	4.6
Y	4.5	9.0	5.7

* It is not warrantable that you can mount the capacitor without trouble under all the mounting condition when "Recommender for Land dimensions" is adopted.

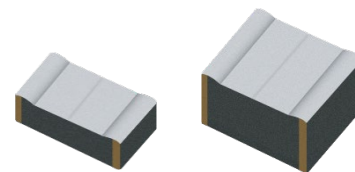

Plastic Film Capacitors

Stacked Metallized PEN Film Chip Capacitor

ECWU(X) series

Stacked metallized PEN film as dielectric with simple mold-less construction.

Features

- Small in size
- 85 °C, 85 %RH, W.V. × 1.0 for 500 hours
- For reflow soldering
- RoHS compliant

Recommended applications

- General purpose (Coupling, By-pass)

Explanation of part number

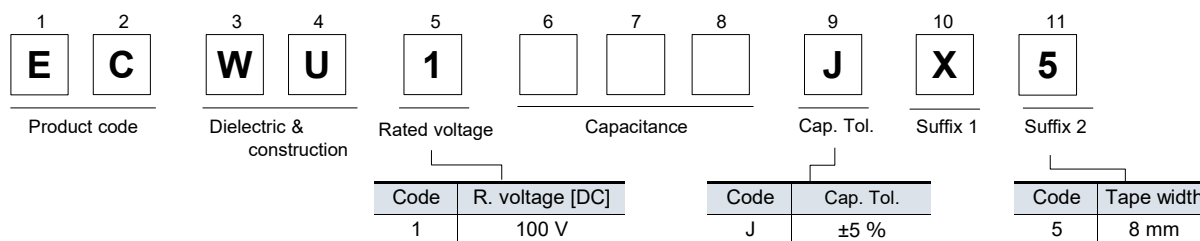

Specifications

Category temp. range (Including temperature-rise on unit surface)	-55 °C to +105 °C
Rated voltage [DC]	100 V
Capacitance range	0.0010 μF to 0.010 μF (E12)
Capacitance tolerance	±5 % (J)
Dissipation factor (tan δ)	tan δ ≤ 1.0 % (20 °C, 1 kHz)
Withstand voltage	Between terminals : Rated voltage (V) × 150 % 60 s
Insulation resistance (IR)	IR ≥ 3000 MΩ (20 °C, 100 V [DC], 60 s)
Soldering conditions	Reflow soldering : 250 °C max. and 60 sec max. at more than 220 °C (Temp. at capacitor surface)

* In case of applying voltage in alternating current (50 Hz or 60 Hz sine wave) to a capacitor with DC rated voltage, please refer to the page of "Permissible voltage (R.M.S) in alternating current corresponding to DC rated voltage".

Construction

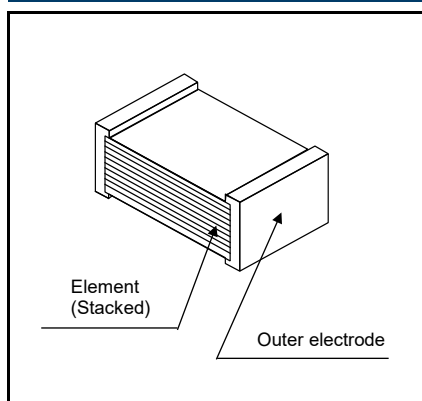

Dimensions

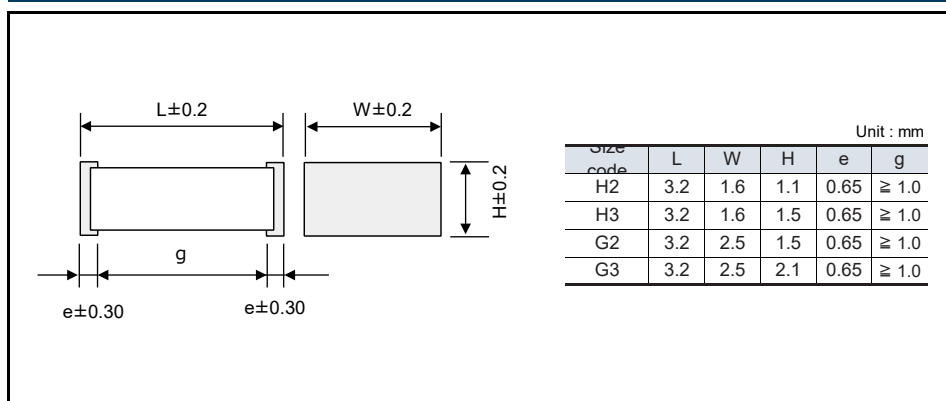

Taping specification for automatic mounting

- Refer to the page of taping specifications

Rating · Dimensions · Quantity

- Capacitance tolerance : $\pm 5\%$ (J)

Capacitance (μF)	Part No.	Rated voltage 100 V [DC]				Size code	Q'ty (PCS)
		Dimensions (mm)					
		L	W	H			
0.0010	ECWU1102JX5	3.2	1.6	1.1	H2	3000	
0.0012	ECWU1122JX5	3.2	1.6	1.1	H2		
0.0015	ECWU1152JX5	3.2	1.6	1.1	H2		
0.0018	ECWU1182JX5	3.2	1.6	1.1	H2		
0.0022	ECWU1222JX5	3.2	1.6	1.1	H2		
0.0027	ECWU1272JX5	3.2	1.6	1.1	H2		
0.0033	ECWU1332JX5	3.2	1.6	1.5	H3	2000	
0.0039	ECWU1392JX5	3.2	1.6	1.5	H3		
0.0047	ECWU1472JX5	3.2	1.6	1.5	H3		
0.0056	ECWU1562JX5	3.2	2.5	1.5	G2		
0.0068	ECWU1682JX5	3.2	2.5	1.5	G2		
0.0082	ECWU1822JX5	3.2	2.5	2.1	G3		
0.010	ECWU1103JX5	3.2	2.5	2.1	G3		

* cap. $\geq 0.012 \mu\text{F}$: Please use 100 V [DC] rating of ECWU(C)

Recommended for land dimensions

The diagram illustrates the recommended land dimensions for reflow soldering. It shows two vertical electrodes with a central land. Dimension A is the distance between the inner edges of the electrodes. Dimension B is the distance between the outer edges of the electrodes. Dimension C is the height of the electrodes. The land is the gap between the electrodes.

Unit : mm

Size code	Land dimensions		
	Reflow soldering		
	A	B	C
H2, H3	1.8	3.6	1.4
G2, G3	1.8	3.6	2.3

* It is not warrantable that you can mount the capacitor without trouble under all the mounting condition when "Recommender for Land dimensions" is adopted.

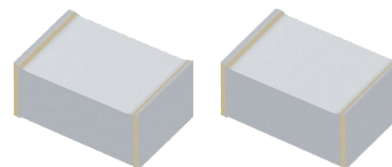

Plastic Film Capacitors

Stacked Metallized PEN Film Chip Capacitor

ECWU(C) series

Stacked metallized PEN film as dielectric with simple mold-less construction.

Features

- Small in size
- For reflow soldering
- RoHS compliant

Recommended applications

- General purpose (Coupling, By-pass)

Explanation of part number

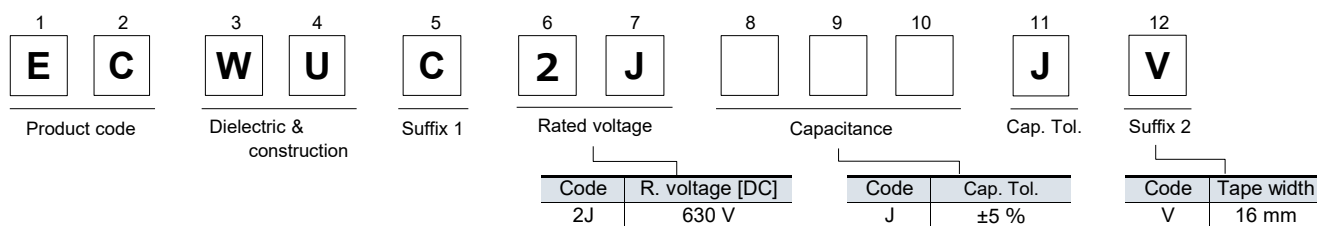
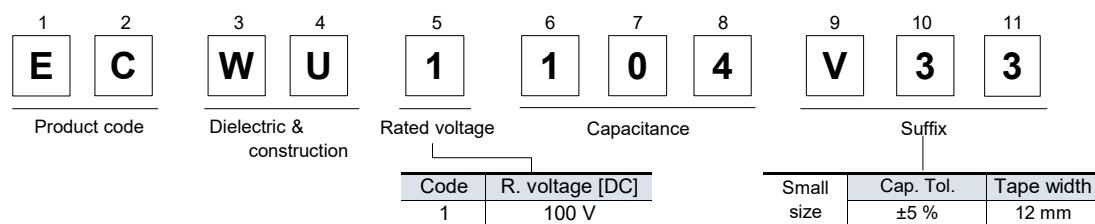
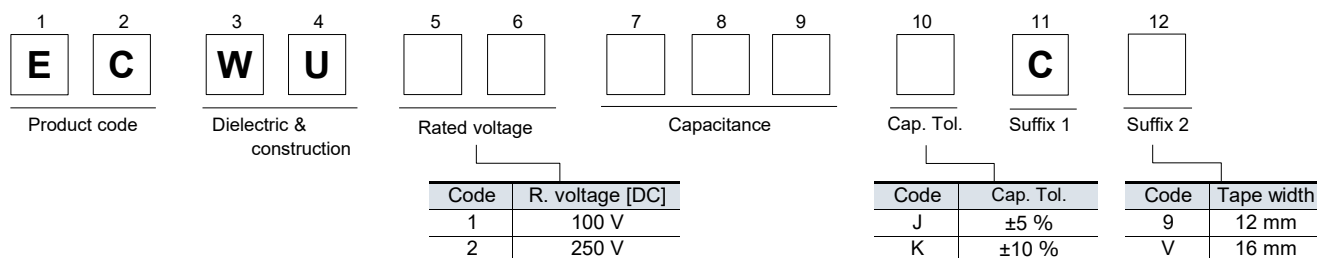

Specifications

Category temp. range (Including temperature-rise on unit surface)	-55 °C to +125 °C	
Rated voltage [DC]	100 V, 250 V, 630 V (Derating of rated voltage by 1.25 %/°C more than 85 °C)	
Capacitance range	100 V	0.012 μF to 1.0 μF (E12)
	250 V	0.0010 μF to 0.12 μF (E12)
	630 V	0.022 μF, 0.027 μF, 0.033 μF
Capacitance tolerance	100 V	±5 % (J), ±10 % (K) (C ≥ 0.18 μF : ±10 % (K) Only)
	250 V	±5 % (J), ±10 % (K)
	630 V	±5 % (J)
Dissipation factor (tan δ)	tan δ ≤ 1.0 % (20 °C, 1 kHz)	
Withstand voltage	Between terminals : Rated voltage (V) × 150 % 60 s	
Insulation resistance (IR)	C ≤ 0.33 μF	100 V, 250 V, 630 V : IR ≥ 3000 MΩ (20 °C, 100 V, 60 s)
	C > 0.33 μF	100 V : IR ≥ 1000 MΩ·μF (20 °C, 100 V, 60 s)
Soldering conditions	100 V	Reflow soldering : 250 °C max. and 60 s max. at more than 220 °C (Temp. at capacitor surface)
	250 V	
	630 V	Reflow soldering : 250 °C max. and 60 s to 150 s. at more than 217 °C (Temp. at cap. surface)

* In case of applying voltage in alternating current (50 Hz or 60 Hz sine wave) to a capacitor with DC rated voltage, please refer to the page of "Permissible voltage (R.M.S) in alternating current corresponding to DC rated voltage".

* Please consult us for capacitance range between 0.15 μF and 1.0 μF. (250 V [DC])

Construction

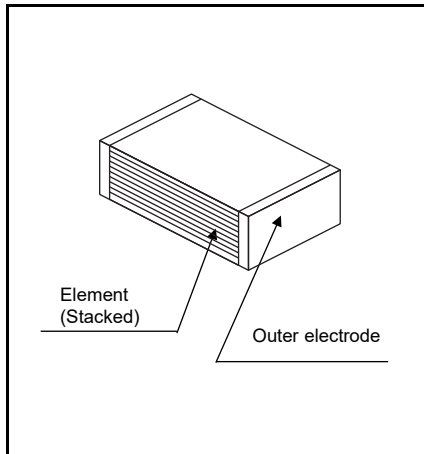

Dimensions

Unit : mm

Size code	L	W	H
E1	4.8	3.3	1.4
E2	4.8	3.3	2.0
E3a	4.8	3.3	2.4
E3	4.8	3.3	2.8
D1	6.0	4.1	1.8
D2	6.0	4.1	2.0
D3	6.0	4.1	2.4
D4	6.0	4.1	2.8
D5	6.0	4.1	3.2
B	6.0	5.0	*
Z	7.1	5.0	
X	7.7	5.5	
V	9.8	6.3	

* Refer to the column "Rating, Dimensions & Quantity".

*1: To be applied only for size code Z, X.
 *2: To be applied only for size code V.
 *3: To be applied only for size code B, Z, X, V.

Taping specification for automatic mounting

■ Refer to the page of taping specifications

Rating · Dimensions · Quantity

■ Capacitance tolerance : ±5 %(J), ±10 %(K)

Capacitance (μF)	Rated voltage 100 V					Rated voltage 250 V						
	Part No.	Dimensions (mm)			Size code	Q'ty (PCS)	Part No.	Dimensions (mm)			Size code	Q'ty (PCS)
		L	W	H				L	W	H		
0.0010	Please use 0.001 μF to 0.01 μF rating ECWU(X)	4.8	3.3	1.4	E1	3000	ECWU2102□C9	4.8	3.3	1.4	E1	1500
0.0012							ECWU2122□C9	4.8	3.3	1.4	E1	
0.0015							ECWU2152□C9	4.8	3.3	1.4	E1	
0.0018							ECWU2182□C9	4.8	3.3	1.4	E1	
0.0022							ECWU2222□C9	4.8	3.3	1.4	E1	
0.0027							ECWU2272□C9	4.8	3.3	1.4	E1	
0.0033							ECWU2332□C9	4.8	3.3	1.4	E1	
0.0039							ECWU2392□C9	4.8	3.3	1.4	E1	
0.0047							ECWU2472□C9	4.8	3.3	1.4	E1	
0.0056							ECWU2562□C9	4.8	3.3	1.4	E1	
0.0068							ECWU2682□C9	4.8	3.3	1.4	E1	
0.0082							ECWU2822□C9	4.8	3.3	1.4	E1	
0.010							ECWU2103□C9	4.8	3.3	1.4	E1	
0.012							ECWU1123□C9	4.8	3.3	1.4	E1	
0.015							ECWU1153□C9	4.8	3.3	1.4	E1	
0.018	ECWU1183□C9	4.8	3.3	1.4	E1							
0.022	ECWU1223□C9	4.8	3.3	1.4	E1							
0.027	ECWU1273□C9	4.8	3.3	1.4	E1							
0.033	ECWU1333□C9	4.8	3.3	1.4	E1							
0.039	ECWU1393□C9	4.8	3.3	1.4	E1							
0.047	ECWU1473□C9	4.8	3.3	2.0	E2							
0.056	ECWU1563□C9	4.8	3.3	2.0	E2							
0.068	ECWU1683□C9	4.8	3.3	2.4	E3a							
0.082	ECWU1823□C9	4.8	3.3	2.8	E3							
0.10	ECWU1104□C9	6.0	4.1	1.8	D1							
	ECWU1104V33	4.8	3.3	2.8	E3							
0.12	ECWU1124□C9	6.0	4.1	2.4	D3							
0.15	ECWU1154□C9	6.0	4.1	2.8	D4							
0.18	ECWU1184KC9	7.1	5.0	2.0	Z							
0.22	ECWU1224KC9	7.1	5.0	2.4	Z							
0.27	ECWU1274KC9	7.1	5.0	2.9	Z							
0.33	ECWU1334KC9	7.1	5.0	3.5	Z							
0.39	ECWU1394KCV	7.7	5.5	3.4	x							
0.47	ECWU1474KCV	7.7	5.5	4.0	x							
0.56	ECWU1564KCV	9.8	6.3	3.0	V							
0.68	ECWU1684KCV	9.8	6.3	3.6	V							
0.82	ECWU1824KCV	9.8	6.3	4.3	V							
1.0	ECWU1105KCV	9.8	6.3	5.1	V							

* □ : Capacitance tolerance

Rating · Dimensions · Quantity

■ Capacitance tolerance : $\pm 5\%$ (J)

Capacitance (μF)	Part No.	Rated voltage 630 V			Size code	Q'ty (PCS)
		Dimensions (mm)				
		L	W	H		
0.022	ECWUC2J223JV	7.1	6.3	3.6	Y	1000
0.027	ECWUC2J273JV	7.1	6.3	4.1	Y	
0.033	ECWUC2J333JV	7.1	6.3	5.1	Y	

Recommended for land dimensions

Unit : mm

Size code	Land dimensions		
	Reflow soldering		
	A	B	C
E1, E2, E3a, E3	2.6	6.6	3.0
D1, D2, D3, D4, D5	3.8	7.8	3.8
B	3.8	7.8	4.6
Z	4.5	9.0	4.6
Y	4.5	9.0	5.7
X	5.1	9.7	5.0
V	7.2	11.9	5.7

* It is not warrantable that you can mount the capacitor without trouble under all the mounting condition when "Recommender for Land dimensions" is adopted.

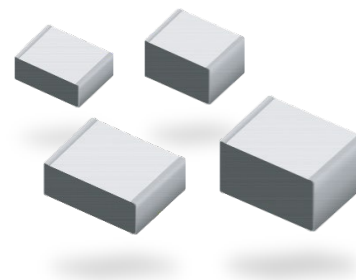

Plastic Film Capacitors

Stacked Metallized PEN Film Chip Capacitor

ECWU(V16) series

Stacked metallized PEN film dielectric with simple mold-less construction for DC Blocking for xDSL.

Features

- Small in size
- For reflow soldering
- RoHS compliant

Recommended applications

- DC Blocking for xDSL

Explanation of part number

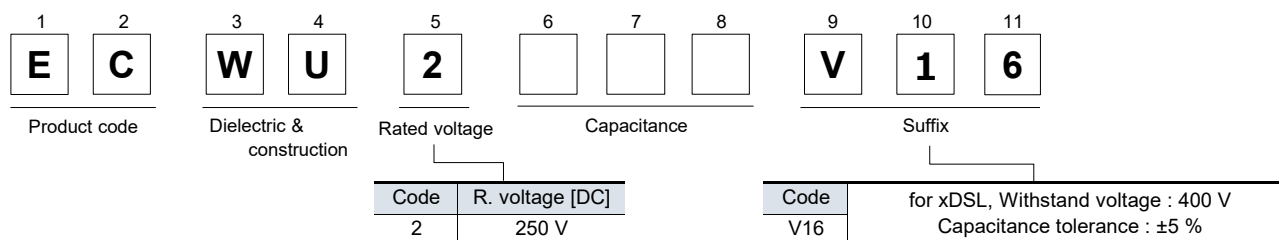

Specifications

Category temp. range (Including temperature-rise on unit surface)	-55 °C to +85 °C
Rated voltage [DC]	250 V
Capacitance range	0.0010 μF to 0.12 μF (E12)
Capacitance tolerance	±5 % (J)
Dissipation factor (tan δ)	tan δ ≤ 1.0 % (20 °C, 1 kHz)
Withstand voltage	Between terminals : 400 V [DC], 60 s
Insulation resistance (IR)	IR ≥ 3000 MΩ (20 °C, 100 V [DC], 60 s)
Soldering conditions	Reflow soldering : 250 °C max. and 60 s max. at more than 220 °C (Temp. at capacitor surface)

* In case of applying voltage in alternating current (50 Hz or 60 Hz sine wave) to a capacitor with DC rated voltage, please refer to the page of "Permissible voltage (R.M.S) in alternating current corresponding to DC rated voltage".

Construction

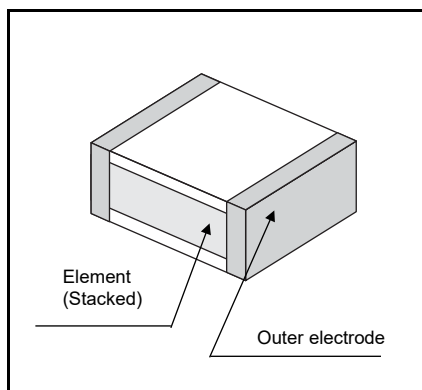

Dimensions

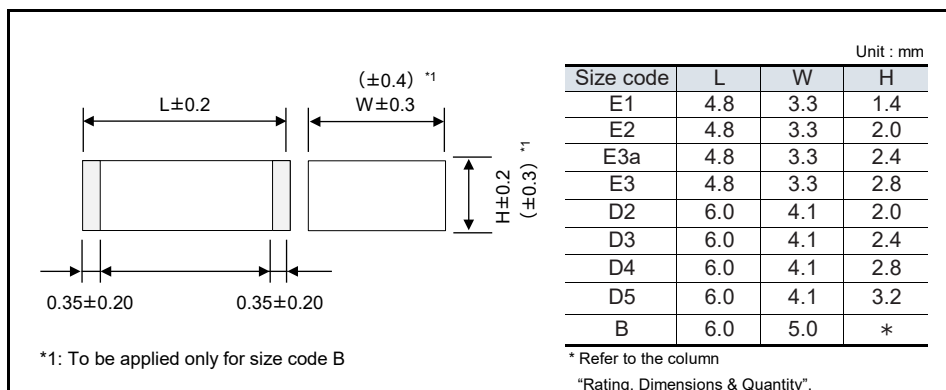

Taping specification for automatic mounting

■ Refer to the page of taping specifications

Rating · Dimensions · Quantity

■ Capacitance tolerance : ±5 %(J)

Capacitance (μF)	Rated voltage 250 V					Q'ty (PCS)
	Part No.	Dimensions (mm)			Size code	
		L	W	H		
0.0010	ECWU2102V16	4.8	3.3	1.4	E1	3000
0.0012	ECWU2122V16	4.8	3.3	1.4	E1	
0.0015	ECWU2152V16	4.8	3.3	1.4	E1	
0.0018	ECWU2182V16	4.8	3.3	1.4	E1	
0.0022	ECWU2222V16	4.8	3.3	1.4	E1	
0.0027	ECWU2272V16	4.8	3.3	1.4	E1	
0.0033	ECWU2332V16	4.8	3.3	1.4	E1	
0.0039	ECWU2392V16	4.8	3.3	1.4	E1	
0.0047	ECWU2472V16	4.8	3.3	1.4	E1	
0.0056	ECWU2562V16	4.8	3.3	1.4	E1	
0.0068	ECWU2682V16	4.8	3.3	1.4	E1	
0.0082	ECWU2822V16	4.8	3.3	1.4	E1	
0.010	ECWU2103V16	4.8	3.3	1.4	E1	
0.012	ECWU2123V16	4.8	3.3	1.4	E1	
0.015	ECWU2153V16	4.8	3.3	1.4	E1	
0.018	ECWU2183V16	4.8	3.3	2.0	E2	
0.022	ECWU2223V16	4.8	3.3	2.0	E2	
0.027	ECWU2273V16	4.8	3.3	2.4	E3a	
0.033	ECWU2333V16	4.8	3.3	2.8	E3	
0.039	ECWU2393V16	6.0	4.1	2.0	D2	3000
0.047	ECWU2473V16	6.0	4.1	2.4	D3	2000
0.056	ECWU2563V16	6.0	4.1	2.8	D4	
0.068	ECWU2683V16	6.0	4.1	3.2	D5	
0.082	ECWU2823V16	6.0	5.0	3.2	B	1500
0.10	ECWU2104V16	6.0	5.0	3.8	B	
0.12	ECWU2124V16	6.0	5.0	4.5	B	

Recommended for land dimensions

The diagram illustrates the recommended land dimensions for automatic mounting. It shows two vertical electrodes with a central land. Dimension 'C' is the height of the electrodes. Dimension 'A' is the width of the land. Dimension 'B' is the total width including the electrodes. The label 'Electrode' points to the top of the electrodes, and 'Land' points to the central gap between them.

Unit : mm

Size code	Land dimensions		
	Reflow soldering		
	A	B	C
E1, E2, E3a, E3	2.6	6.6	3.0
D2, D3, D4, D5	3.8	7.8	3.8
B	3.8	7.8	4.6

* It is not warrantable that you can mount the capacitor without trouble under all the mounting condition when "Recommender for Land dimensions" is adopted.

! This series is not a recommended product.
Not recommended for new design.

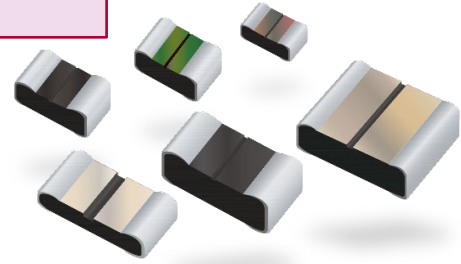

Plastic Film Capacitors

Stacked Metallized Film Chip Capacitor

ECPU(A) series

Stacked dielectric and inner electrode with simple mold-less construction.

Features

- Low ESR
- Small size & large capacitance
- For reflow soldering
- RoHS compliant

Recommended applications

- Noise suppressor circuit
- Audio circuit

Explanation of part number

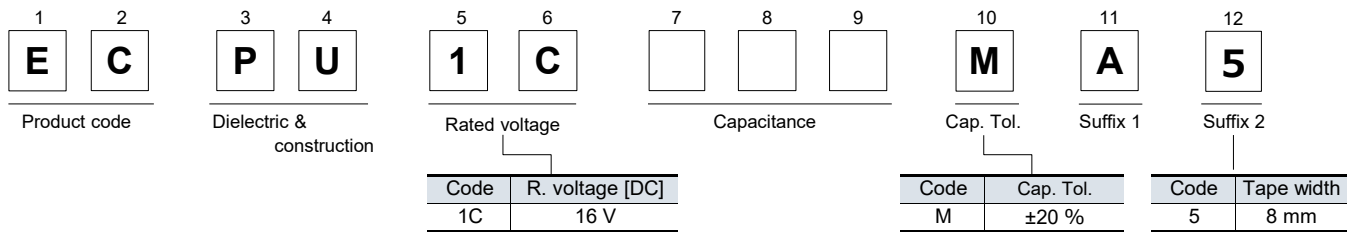

Specifications

Category temp. range (Including temperature-rise on unit surface)	-40 °C to +85 °C	
Rated voltage [DC]	16 V	
Capacitance range	0.10 µF to 1.0 µF (E6)	
Capacitance tolerance	±20 %(M)	
Dissipation factor (tan δ)	tan δ ≤ 1.5 % (20 °C, 1 kHz)	
Withstand voltage	Between terminals : Rated voltage (V) × 150 % 60 s	
Insulation resistance (IR)	C ≤ 0.33 µF	IR ≥ 1000 MΩ (20 °C, 10 V [DC], 60 s)
	C > 0.33 µF	IR ≥ 300 MΩ·µF (20 °C, 10 V [DC], 60 s)
Soldering conditions	Reflow soldering : 240 °C max. and 30 sec max. at more than 220 °C (Temp. at capacitor surface)	

* In case of applying voltage in alternating current (50 Hz or 60 Hz sine wave) to a capacitor with DC rated voltage, please refer to the page of "Permissible voltage (R.M.S) in alternating current corresponding to DC rated voltage".

Construction

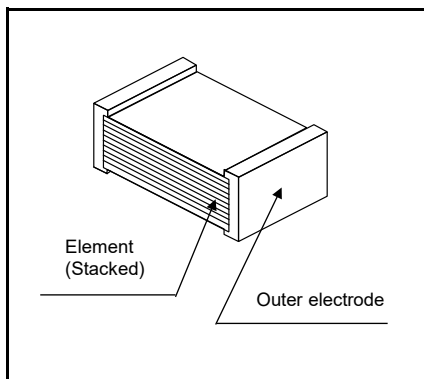

Dimensions

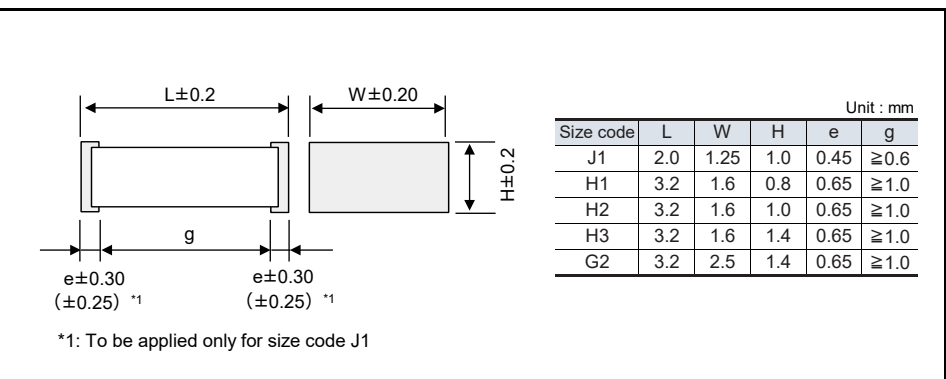

Taping specification for automatic mounting

- Refer to the page of taping specifications

Rating · Dimensions · Quantity

- Capacitance tolerance : $\pm 20\%$ (M)

Capacitance (μF)	Rated voltage 16 V [DC]					Q'ty (PCS)
	Part No.	Dimensions (mm)			Size code	
		L	W	H		
0.10	ECP(U)1C104MA5	2.0	1.25	1.0	J1	3000
0.15	ECP(U)1C154MA5	3.2	1.6	0.8	H1	
0.22	ECP(U)1C224MA5	3.2	1.6	0.8	H1	
0.33	ECP(U)1C334MA5	3.2	1.6	1.0	H2	
0.47	ECP(U)1C474MA5	3.2	1.6	1.4	H3	2000
0.68	ECP(U)1C684MA5	3.2	1.6	1.4	H3	
1.00	ECP(U)1C105MA5	3.2	2.5	1.4	G2	

Recommended for land dimensions

The diagram illustrates the recommended land dimensions for reflow soldering. It shows two vertical electrodes with a central land. Dimension 'C' is the height of the electrodes. Dimension 'A' is the width of the land. Dimension 'B' is the distance between the inner edges of the electrodes. The label 'Electrode' points to the top of the right electrode.

Unit : mm

Size code	Land dimensions		
	Reflow soldering		
	A	B	C
J1	0.8	2.4	1.1
H1	1.8	3.6	1.4
H2	1.8	3.6	1.4
H3	1.8	3.6	1.4
G2	1.8	3.6	2.3

* It is not warrantable that you can mount the capacitor without trouble under all the mounting condition when "Recommender for Land dimensions" is adopted.

 Some part numbers are not a recommended product. Not recommended for new design.

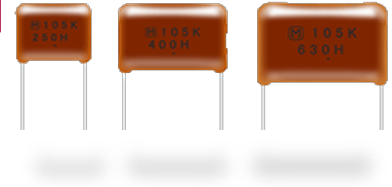

Plastic Film Capacitors

Metallized Polyester Film Capacitor

ECQE(F) series

Non-inductive construction using metallized polyester film with flame retardant epoxy resin coating

Features

- Self-healing property
- Excellent electrical characteristics
- Flame retardant epoxy resin coating
- RoHS compliant

Recommended applications

- General purpose usage
※Please contact us when applications are CDI , ignitor etc.

Explanation of part number

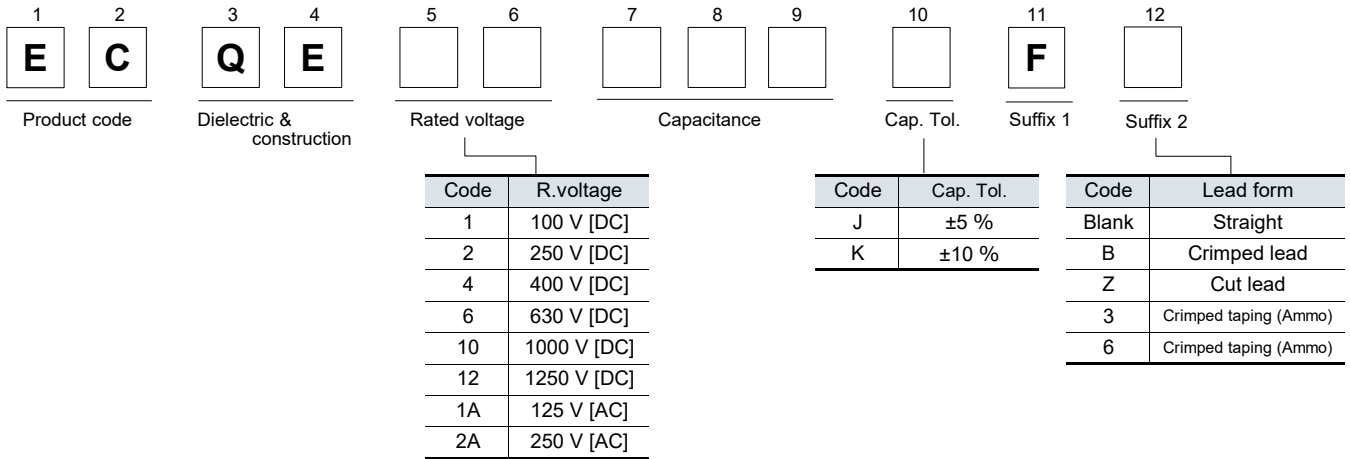

- Odd size taping

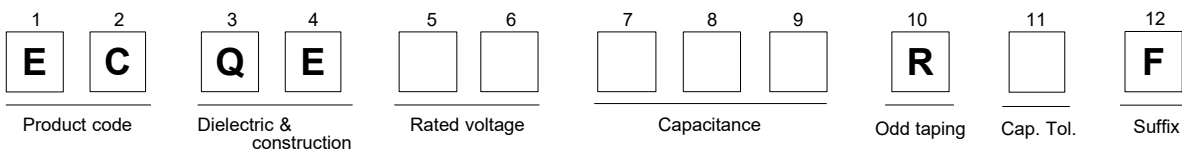

Specifications

Category temp. range (Including temperature-rise on unit surface)	100V to 1250V [DC]	-40 °C to +105 °C	
	125 V, 250 V [AC]	-40 °C to +105 °C	
Rated voltage	100 V, 250 V, 400 V, 630 V, 1000 V, 1250 V [DC] (Derating of rated voltage by 1.25 %/°C at more than 85 °C) 125 V, 250 V [AC]		
Capacitance range	100 V [DC]	0.56 μF to 10.0 μF (E12)	
	250 V [DC]	0.010 μF to 10.0 μF (E12)	
	400 V [DC]	0.010 μF to 2.2 μF (E12)	
	630 V [DC]	★0.0010 μF to 0.0047 μF (E12)	0.0056 μF to 2.2 μF (E12)
	1000 V [DC]	0.010 μF to 0.22 μF (E12)	
	1250 V [DC]	★0.0010 μF to 0.0027 μF (E12)	0.0033 μF to 0.22 μF (E12)
	125 V [AC]	0.010 μF to 0.068 μF (E12)	
	250 V [AC]	0.010 μF to 2.2 μF (E12)	
Capacitance tolerance	±5 % (J), ±10 % (K)		
Dissipation factor (tan δ)	tan δ ≤ 1.0 % (20 °C, 1 kHz)		
Withstand voltage	100V to 630V [DC]	Between terminals : R.voltage (V [DC]) × 150 %, 60 s	
	1000 V [DC] 1250 V [DC]	Between terminals : R.voltage (V) × 175 %, 2 s to 5 s or 1000 V [AC], 60 s Between terminals to enclosure : 1500 V [AC], 60 s	
	125 V [AC] 250 V [AC]	Between terminals : R.voltage (V) × 230 %, 60 s Between terminals to enclosure : 1500 V [AC], 60 s	
Insulation resistance (IR)	100V to 630V [DC]	C ≤ 0.33 μF : IR ≥ 9000 MΩ (20 °C, 100 V [DC], 60 s) C > 0.33 μF : IR ≥ 3000 MΩ · μF (20 °C, 100 V [DC], 60 s)	
	1000 V [DC] 1250 V [DC]	IR ≥ 10000 MΩ (20 °C, 100 V [DC], 60 s) IR ≥ 2000 MΩ (20 °C, 500 V [DC], 60 s)	
	125 V [AC] 250 V [AC]	C ≤ 0.47 μF : IR ≥ 2000 MΩ (20 °C, 500 V [DC], 60 s) C > 0.47 μF : IR ≥ 3000 MΩ · μF (20 °C, 100 V [DC], 60 s)	

★Products in the capacitance range have been designated Not Recommended for New Design.

- * In case of applying voltage in alternating current (50 Hz or 60 Hz sine wave) to a capacitor with DC rated voltage, please refer to the page of "Permissible voltage (R.M.S) in alternating current corresponding to DC rated voltage".
- * Voltage to be applied to ECQE1A (F) & ECQE2A (F) is only sine wave (50 Hz or 60 Hz).

Dimensions

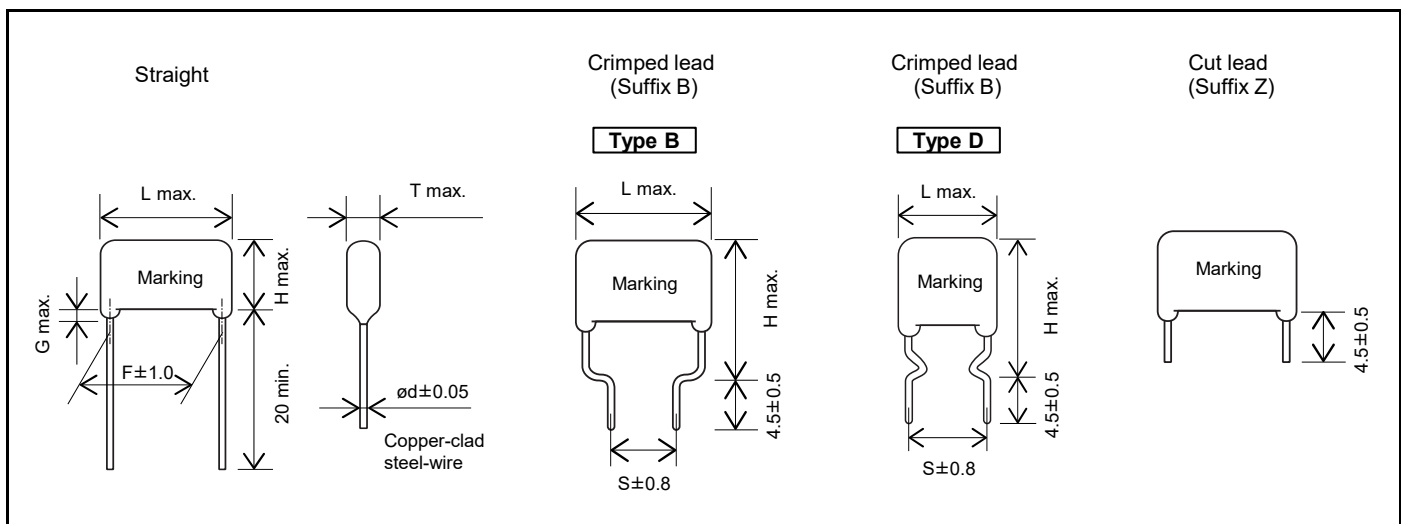

Packaging specifications for bulk package

- Packing quantity : 100 pcs./bag

Taping specifications for automatic insertion

■ Taping style

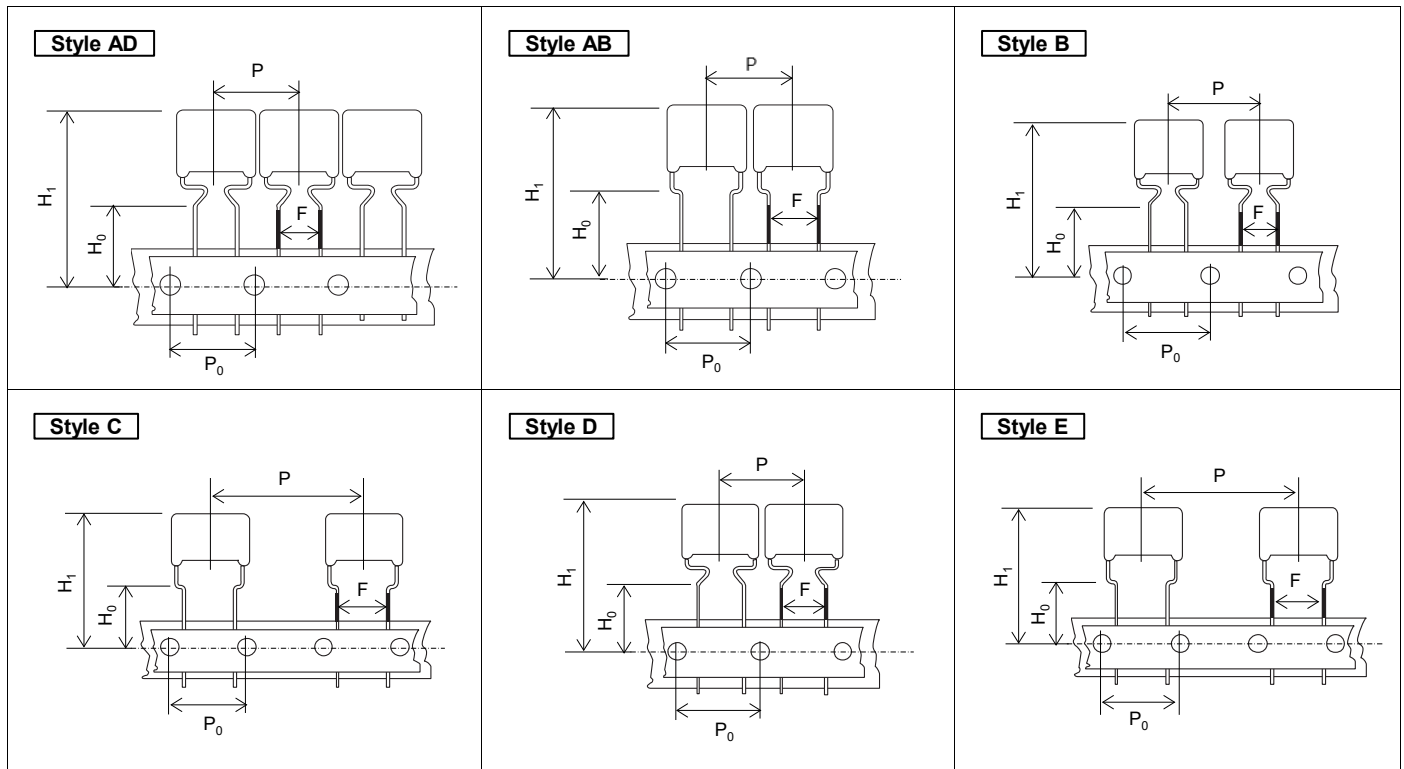

* Please check the product drawing for the shape of the lead wire forming.

The above diagram shows the taping dimensions, and the lead wire forming shape is an example.

* H₁ dimension is based on insertion machine "Panaset RH series" made by Panasonic. Consult with Panasonic technical staff when using other insertion machines.

Size list

Unit : mm

	Style					
	AD	AB	B	C	D	E
P	12.7	12.7	15.0	25.4	15.0	30.0
P ₀	12.7	12.7	15.0	12.7	15.0	15.0
F	5.0	5.0	5.0	5.0	7.5	7.5
H ₀	16.0	16.0	16.0	16.0	16.0	16.0
H ₁ *	34.0	34.0	39.0	39.0	44.0	44.0

*.max.

■ Packaging specifications

Series	R.voltage	Capacitance range (μF)	Taping style							Packing	Suffix
			AD	AB	B	C	D	E			
ECQE(F)	100 V [DC]	0.56 to 0.68	○							Ammo	() F3
		0.82 to 1.0			○					Ammo	() F3
		1.2 to 3.3				○				Ammo	() F3
		1.2 to 3.3						○		Ammo	R() F
	250 V [DC]	0.010 to 0.27	○							Ammo	() F3
		0.33			○					Ammo	() F3
		0.39 to 1.5				○				Ammo	() F3
		0.010 to 0.33					○			Ammo	R() F
	400 V [DC]	0.39 to 1.5						○		Ammo	R() F
		0.010 to 0.10	○							Ammo	() F3
		0.12 to 0.47				○				Ammo	() F3
		0.010 to 0.10					○			Ammo	R() F
	630 V [DC]	0.12 to 0.47						○		Ammo	R() F
		0.0010 to 0.033	○							Ammo	() F3
		0.039 to 0.047			○					Ammo	() F3
		0.056 to 0.22				○				Ammo	() F3
1000 V [DC]	0.001 to 0.047					○			Ammo	R() F	
	0.056 to 0.22						○		Ammo	R() F	
1250 V [DC]	0.010 to 0.10						○		Ammo	R() F	
125 V [AC]	0.0010 to 0.022						○		Ammo	R() F	
	0.010 to 0.068			○					Ammo	() F6	
250 V [AC]	0.010 to 0.068					○			Ammo	R() F	
	0.010 to 0.033			○					Ammo	() F6	
	0.010 to 0.047					○			Ammo	R() F	
	0.056 to 0.22						○		Ammo	R() F	

See the column "Rating · Dimensions · Quantity" for packaging quantity

● Lead spacing

Style	Lead spacing
AD	5.0
AB	5.0
B	5.0
C	5.0
D	7.5
E	7.5

Unit : mm

Rating · Dimensions · Quantity

■ Rated voltage [DC] : 100 V, Capacitance tolerance : ±5 % (J), ±10 % (K)

Part No.	Cap. (μF)	Dimensions (mm)								Min. order Q'ty (PCS)				
		L max.	T max.	H max.		F		S	G max.	ød	Taping			Bulk Straight· Crimped lead
				Straight	Crimped lead	Straight	Crimped lead	Straight	Standard 5.0 mm		Odd size 5.0 mm	Odd size 7.5 mm		
ECQE1564□F()	0.56	12.0	5.5	10.9	15.9	10.0	10.0	1.0	0.6	500	-	-	500	
ECQE1684□F()	0.68	12.0	6.0	11.9	16.9	10.0	10.0	1.0	0.6					
ECQE1824□F()	0.82	12.0	6.0	13.5	18.5	10.0	10.0	1.0	0.6					
ECQE1105□F()	1.0	12.0	6.7	14.0	19.0	10.0	10.0	1.0	0.6					
ECQE1125□F()	1.2	18.5	5.5	12.8	17.8	15.0	10.0	1.0	0.6					
ECQE1155□F()	1.5	18.5	6.0	13.4	18.4	15.0	10.0	1.0	0.8					
ECQE1185□F()	1.8	18.5	6.5	14.4	19.4	15.0	10.0	1.0	0.8					
ECQE1225□F()	2.2	18.5	7.0	15.0	20.0	15.0	10.0	1.0	0.8					
ECQE1275□F()	2.7	18.5	8.0	15.8	20.8	15.0	10.0	1.0	0.8					
ECQE1335□F()	3.3	18.5	8.5	16.5	21.5	15.0	10.0	1.0	0.8					
ECQE1395□F()	3.9	26.0	7.0	16.4	21.4	22.5	15.0	1.0	0.8					
ECQE1475□F()	4.7	26.0	7.5	17.0	22.0	22.5	15.0	1.0	0.8					
ECQE1565□F()	5.6	26.0	8.3	17.5	22.5	22.5	15.0	1.0	0.8					
ECQE1685□F()	6.8	26.0	9.0	18.5	23.5	22.5	15.0	1.0	0.8					
ECQE1825□F()	8.2	26.0	10.0	20.0	25.0	22.5	15.0	1.5	0.8					
ECQE1106□F()	10.0	26.0	11.5	21.0	26.0	22.5	15.0	1.5	0.8					

* □ : Capacitance tolerance code
 () : Suffix for lead crimped or taped type

Type D : 0.56 μF to 1.0 μF
 Type B : 1.2 μF to 10.0 μF

■ Rated voltage [DC] : 250 V, Capacitance tolerance : ±5 % (J), ±10 % (K)

Part No.	Cap. (μF)	Dimensions (mm)								Min. order Q'ty (PCS)					
		L max.	T max.	H max.		F		S	G max.	ød	Taping			Bulk	
				Straight	Crimped lead	Straight	Crimped lead	Straight	Standard 5.0 mm		Odd size 5.0 mm	Odd size 7.5 mm	Straight	Crimped lead	
ECQE2103□F()	0.010	10.3	4.3	7.4	12.4	7.5	7.5	1.0	0.6	1000	-	1000	500	500	
ECQE2123□F()	0.012	10.3	4.4	7.5	12.5	7.5	7.5	1.0	0.6						
ECQE2153□F()	0.015	10.3	4.4	7.5	12.5	7.5	7.5	1.0	0.6						
ECQE2183□F()	0.018	10.3	4.4	7.5	12.5	7.5	7.5	1.0	0.6						
ECQE2223□F()	0.022	10.3	4.4	7.5	12.5	7.5	7.5	1.0	0.6						
ECQE2273□F()	0.027	10.3	4.4	7.5	12.5	7.5	7.5	1.0	0.6						
ECQE2333□F()	0.033	10.3	4.5	7.5	12.5	7.5	7.5	1.0	0.6						
ECQE2393□F()	0.039	10.3	4.5	7.5	12.5	7.5	7.5	1.0	0.6						
ECQE2473□F()	0.047	10.3	4.5	7.5	12.5	7.5	7.5	1.0	0.6						
ECQE2563□F()	0.056	10.3	4.8	7.9	12.9	7.5	7.5	1.0	0.6						
ECQE2683□F()	0.068	10.3	4.5	7.5	12.5	7.5	7.5	1.0	0.6						
ECQE2823□F()	0.082	10.3	4.9	8.0	13.0	7.5	7.5	1.0	0.6						
ECQE2104□F()	0.10	10.3	5.8	8.4	13.4	7.5	7.5	1.0	0.6						
ECQE2124□F()	0.12	10.3	6.0	9.0	14.0	7.5	7.5	1.0	0.6						
ECQE2154□F()	0.15	10.3	6.0	10.8	15.8	7.5	7.5	1.0	0.6						
ECQE2184□F()	0.18	12.0	5.0	10.3	15.3	10.0	10.0	1.0	0.6						
ECQE2224□F()	0.22	12.0	5.5	10.5	15.5	10.0	10.0	1.0	0.6						
ECQE2274□F()	0.27	12.0	6.0	11.5	16.5	10.0	10.0	1.0	0.6						
ECQE2334□F()	0.33	12.0	6.5	12.0	17.0	10.0	10.0	1.0	0.6						
ECQE2394□F()	0.39	18.5	4.9	12.0	17.0	15.0	10.0	1.0	0.6						
ECQE2474□F()	0.47	18.5	5.3	12.5	17.5	15.0	10.0	1.0	0.6						
ECQE2564□F()	0.56	18.5	5.5	13.0	18.0	15.0	10.0	1.0	0.6						
ECQE2684□F()	0.68	18.5	6.0	13.5	18.5	15.0	10.0	1.0	0.8						
ECQE2824□F()	0.82	18.5	6.5	14.5	19.5	15.0	10.0	1.0	0.8						
ECQE2105□F()	1.0	18.5	7.4	15.0	20.0	15.0	10.0	1.0	0.8						
ECQE2125□F()	1.2	18.5	8.0	15.9	20.9	15.0	10.0	1.0	0.8						
ECQE2155□F()	1.5	18.5	9.0	16.8	21.8	15.0	10.0	1.0	0.8						
ECQE2185□F()	1.8	26.0	7.5	15.5	20.5	22.5	15.0	1.0	0.8						
ECQE2225□F()	2.2	26.0	8.5	16.3	21.3	22.5	15.0	1.0	0.8						
ECQE2275□F()	2.7	26.0	9.4	17.0	22.0	22.5	15.0	1.0	0.8						
ECQE2335□F()	3.3	26.0	10.3	18.0	23.0	22.5	15.0	1.5	0.8						
ECQE2395 F()	3.9	26.0	11.0	20.5	25.5	22.5	15.0	1.5	0.8						
ECQE2475□F()	4.7	26.0	12.0	21.5	26.5	22.5	15.0	1.5	0.8						
ECQE2565□F()	5.6	31.0	11.8	21.0	26.0	27.5	22.5	1.5	0.8						
ECQE2685□F()	6.8	31.0	13.0	22.4	27.4	27.5	22.5	1.5	0.8						
ECQE2825□F()	8.2	31.0	14.3	23.5	28.5	27.5	22.5	1.5	0.8						
ECQE2106□F()	10.0	31.0	15.9	25.8	30.8	27.5	22.5	1.5	0.8						

* □ : Capacitance tolerance code
 () : Suffix for lead crimped or taped type

Type D : 0.010 μF to 0.33 μF
 Type B : 0.39 μF to 10.0 μF

Rating · Dimensions · Quantity

■ Rated voltage [DC] : 400 V, Capacitance tolerance : ±5 %(J), ±10 %(K)

Part No.	Cap. (μF)	Dimensions (mm)								Min. order Q'ty (PCS)					
		L max.	T max.	H max.		F		S		G max. Straight	ød	Taping			Bulk Straight- Crimped lead
				Straight	Crimped lead	Straight	Crimped lead	Straight	Crimped lead			Standard 5.0 mm	Odd size 5.0 mm	Odd size 7.5 mm	
ECQE4103□F()	0.010	10.3	4.3	7.4	12.4	7.5	7.5	1.0	0.6	1000	-	1000	500		
ECQE4123□F()	0.012	10.3	4.4	7.5	12.5	7.5	7.5	1.0	0.6						
ECQE4153□F()	0.015	10.3	4.4	7.5	12.5	7.5	7.5	1.0	0.6						
ECQE4183□F()	0.018	10.3	4.4	7.5	12.5	7.5	7.5	1.0	0.6						
ECQE4223□F()	0.022	10.3	4.8	7.9	12.9	7.5	7.5	1.0	0.6						
ECQE4273□F()	0.027	10.3	5.5	8.0	13.0	7.5	7.5	1.0	0.6						
ECQE4333□F()	0.033	10.3	6.0	9.0	14.0	7.5	7.5	1.0	0.6	500	-	1000			
ECQE4393□F()	0.039	12.0	4.9	8.0	13.0	10.0	10.0	1.0	0.6						
ECQE4473□F()	0.047	12.0	5.0	8.3	13.3	10.0	10.0	1.0	0.6						
ECQE4563□F()	0.056	12.0	5.0	10.0	15.0	10.0	10.0	1.0	0.6						
ECQE4683□F()	0.068	12.0	5.4	10.5	15.5	10.0	10.0	1.0	0.6						
ECQE4823□F()	0.082	12.0	5.8	11.0	16.0	10.0	10.0	1.0	0.6						
ECQE4104□F()	0.10	12.0	6.3	12.0	17.0	10.0	10.0	1.0	0.6	-	500	500			
ECQE4124□F()	0.12	18.5	5.0	10.0	15.0	15.0	10.0	1.0	0.6						
ECQE4154□F()	0.15	18.5	5.0	12.4	17.4	15.0	10.0	1.0	0.6						
ECQE4184□F()	0.18	18.5	5.4	12.5	17.5	15.0	10.0	1.0	0.6						
ECQE4224□F()	0.22	18.5	5.9	13.0	18.0	15.0	10.0	1.0	0.6						
ECQE4274□F()	0.27	18.5	6.5	14.3	19.3	15.0	10.0	1.0	0.8						
ECQE4334□F()	0.33	18.5	7.0	14.9	19.9	15.0	10.0	1.0	0.8						
ECQE4394□F()	0.39	18.5	7.5	15.4	20.4	15.0	10.0	1.0	0.8						
ECQE4474□F()	0.47	18.5	7.8	17.0	22.0	15.0	10.0	1.0	0.8						
ECQE4564□F()	0.56	26.0	6.5	16.0	21.0	22.5	15.0	1.0	0.8						
ECQE4684□F()	0.68	26.0	7.0	16.5	21.5	22.5	15.0	1.0	0.8						
ECQE4824□F()	0.82	26.0	7.9	17.3	22.3	22.5	15.0	1.0	0.8						
ECQE4105□F()	1.0	26.0	8.5	18.0	23.0	22.5	15.0	1.0	0.8	-	-	-			
ECQE4125□F()	1.2	26.0	9.5	18.9	23.9	22.5	15.0	1.0	0.8						
ECQE4155□F()	1.5	31.0	9.5	19.0	24.0	27.5	22.5	1.0	0.8						
ECQE4185□F()	1.8	31.0	11.0	20.5	25.5	27.5	22.5	1.5	0.8						
ECQE4225□F()	2.2	31.0	11.0	22.0	27.0	27.5	22.5	1.5	0.8						

* □ : Capacitance tolerance code
 () : Suffix for lead crimped or taped type

Type D : 0.010 μF to 0.10 μF
 Type B : 0.12 μF to 2.2 μF

Rating · Dimensions · Quantity

■ Rated voltage [DC] : 630 V, Capacitance tolerance : ±5 %(J), ±10 %(K)

Part No.	Cap. (μF)	Dimensions (mm)									Min. order Q'ty (PCS)				
		L max.	T max.	H max.		F	S	G max.	ød	Taping			Bulk		
				Straight	Crimped lead	Straight	Crimped lead	Straight		Standard 5.0 mm	Odd size 5.0 mm	Odd size 7.5 mm	Straight	Crimped lead	
<small>NRFND</small> ECQE6102□F()	0.0010	10.0	4.5	9.5	14.5	7.5	5.0	1.0	0.6	1000	-	1000			
<small>NRFND</small> ECQE6122□F()	0.0012	10.0	4.5	10.0	15.0	7.5	5.0	1.0	0.6						
<small>NRFND</small> ECQE6152□F()	0.0015	10.0	4.5	10.0	15.0	7.5	5.0	1.0	0.6						
<small>NRFND</small> ECQE6182□F()	0.0018	10.0	4.5	10.0	15.0	7.5	5.0	1.0	0.6						
<small>NRFND</small> ECQE6222□F()	0.0022	10.0	4.5	10.0	15.0	7.5	5.0	1.0	0.6						
<small>NRFND</small> ECQE6272□F()	0.0027	10.0	4.5	10.0	15.0	7.5	5.0	1.0	0.6						
<small>NRFND</small> ECQE6332□F()	0.0033	10.0	4.5	10.0	15.0	7.5	5.0	1.0	0.6						
<small>NRFND</small> ECQE6392□F()	0.0039	10.0	4.5	10.0	15.0	7.5	5.0	1.0	0.6						
<small>NRFND</small> ECQE6472□F()	0.0047	12.0	4.5	10.0	15.0	10.0	7.5	1.0	0.6						
ECQE6562□F()	0.0056	12.0	4.5	10.0	15.0	10.0	7.5	1.0	0.6						
ECQE6682□F()	0.0068	12.0	4.9	10.0	15.0	10.0	7.5	1.0	0.6						
ECQE6822□F()	0.0082	12.0	4.5	10.0	15.0	10.0	7.5	1.0	0.6						
ECQE6103□F()	0.010	12.0	4.5	7.5	12.5	10.0	10.0	1.0	0.6						
ECQE6123□F()	0.012	12.0	4.5	7.8	12.8	10.0	10.0	1.0	0.6						
ECQE6153□F()	0.015	12.0	5.0	8.2	13.2	10.0	10.0	1.0	0.6						
ECQE6183□F()	0.018	12.0	4.9	10.0	15.0	10.0	10.0	1.0	0.6						
ECQE6223□F()	0.022	12.0	5.3	10.5	15.5	10.0	10.0	1.0	0.6						
ECQE6273□F()	0.027	12.0	5.5	10.9	15.9	10.0	10.0	1.0	0.6						
ECQE6333□F()	0.033	12.0	6.0	11.9	16.9	10.0	10.0	1.0	0.6						
ECQE6393□F()	0.039	12.0	6.0	13.4	18.4	10.0	10.0	1.0	0.6						
ECQE6473□F()	0.047	12.0	6.5	13.5	18.5	10.0	10.0	1.0	0.6						
ECQE6563□F()	0.056	18.5	5.4	10.5	15.5	15.0	10.0	1.0	0.6						
ECQE6683□F()	0.068	18.5	5.8	11.0	16.0	15.0	10.0	1.0	0.6						
ECQE6823□F()	0.082	18.5	6.5	12.0	17.0	15.0	10.0	1.0	0.6						
ECQE6104□F()	0.10	18.5	6.3	14.0	19.0	15.0	10.0	1.0	0.6						
ECQE6124□F()	0.12	18.5	6.3	14.5	19.5	15.0	10.0	1.0	0.8						
ECQE6154□F()	0.15	18.5	7.5	15.4	20.4	15.0	10.0	1.0	0.8						
ECQE6184□F()	0.18	18.5	8.0	16.0	21.0	15.0	10.0	1.0	0.8						
ECQE6224□F()	0.22	18.5	9.0	16.5	21.5	15.0	10.0	1.0	0.8						
ECQE6274□F()	0.27	26.0	7.0	16.5	21.5	22.5	15.0	1.0	0.8						
ECQE6334□F()	0.33	26.0	7.8	17.0	22.0	22.5	15.0	1.0	0.8						
ECQE6394□F()	0.39	26.0	8.5	17.9	22.9	22.5	15.0	1.0	0.8						
ECQE6474□F()	0.47	26.0	9.3	18.5	23.5	22.5	15.0	1.0	0.8						
ECQE6564□F()	0.56	26.0	10.0	20.0	25.0	22.5	15.0	1.5	0.8						
ECQE6684□F()	0.68	26.0	11.5	21.0	26.0	22.5	15.0	1.5	0.8						
ECQE6824□F()	0.82	31.0	11.3	20.5	25.5	27.5	22.5	1.5	0.8						
ECQE6105□F()	1.0	31.0	12.5	21.9	26.9	27.5	22.5	1.5	0.8						
ECQE6125□F()	1.2	31.0	13.5	23.0	28.0	27.5	22.5	1.5	0.8						
ECQE6155□F()	1.5	31.0	15.3	24.7	29.7	27.5	22.5	1.5	0.8						
ECQE6185□F()	1.8	31.0	16.8	27.0	32.0	27.5	22.5	1.5	0.8						
ECQE6225□F()	2.2	31.0	19.5	29.0	34.0	27.5	22.5	1.5	0.8						

NRFND Not recommended for new design

* □ : Capacitance tolerance code
 () : Suffix for lead crimped or taped type

Type D : 0.010 μF to 0.047 μF
 Type B : 0.0010 μF to 0.0082 μF, 0.056 μF to 2.2 μF

Rating · Dimensions · Quantity

■ Rated voltage [DC] : 1000 V, 125 V [AC]*1, Capacitance tolerance : ±5 %(J), ±10 %(K)

Part No.	Cap. (μF)	Dimensions (mm)								Min. order Qty (PCS)			
		L max.	T max.	H max.		F		S		G max.	ød	Taping	Bulk
				Straight	Crimped lead	Straight	Crimped lead	Straight	Crimped lead			Straight	Crimped lead
ECQE10103□F()	0.010	15.5	6.0	11.0	16.0	12.5	12.5	1.0	0.6	500			
ECQE10123□F()	0.012	15.5	6.0	12.0	17.0	12.5	12.5	1.0	0.6				
ECQE10153□F()	0.015	15.5	7.0	12.5	17.5	12.5	12.5	1.0	0.6				
ECQE10183□F()	0.018	15.5	7.5	13.0	20.0	12.5	12.5	1.0	0.8	400			
ECQE10223□F()	0.022	15.5	7.5	15.5	22.5	12.5	12.5	1.0	0.8				
ECQE10273□F()	0.027	21.0	6.0	13.0	18.0	17.5	12.5	1.0	0.8	500			
ECQE10333□F()	0.033	21.0	6.5	14.0	19.0	17.5	12.5	1.0	0.8				
ECQE10393□F()	0.039	21.0	7.0	14.5	19.5	17.5	12.5	1.0	0.8	400		500	
ECQE10473□F()	0.047	21.0	7.5	15.5	20.5	17.5	12.5	1.0	0.8				
ECQE10563□F()	0.056	21.0	7.5	17.0	22.0	17.5	12.5	1.0	0.8				
ECQE10683□F()	0.068	21.0	8.5	18.0	23.0	17.5	12.5	1.0	0.8	300			
ECQE10823□F()	0.082	21.0	9.0	18.5	23.5	17.5	12.5	1.0	0.8				
ECQE10104□F()	0.10	21.0	10.0	20.0	25.0	17.5	12.5	1.0	0.8	-			
ECQE10124□F()	0.12	26.0	9.0	18.5	23.5	22.5	17.5	1.0	0.8				
ECQE10154□F()	0.15	26.0	10.0	20.0	25.0	22.5	17.5	1.5	0.8				
ECQE10184□F()	0.18	26.0	10.5	22.0	27.0	22.5	17.5	1.5	0.8				
ECQE10224□F()	0.22	26.0	12.0	23.0	28.0	22.5	17.5	1.5	0.8				

* □ : Capacitance tolerance code
 () : Suffix for lead crimped or taped type

Type D : 0.010 μF to 0.022 μF
 Type B : 0.027 μF to 0.22 μF

*1 : This type has two rated voltage, one is DC rated voltage another is AC rated voltage.
 DC rated voltage is 1000 V [DC], AC rated voltage is 125 V [AC].
 Making for rated voltage is “1000 V, 125 V~”

When capacitors use in secondary side of power source, and in case of applying voltage in altering current (50 Hz or 60 Hz sine wave) to a capacitor, please refer to the page of “Permissible voltage (R.M.S) in altering current corresponding to DC rated voltage”.

When capacitors use in primary side of power source, the rated voltage is shown 125 V [AC]. Voltage to be applied to capacitors in only sine wave (50 Hz or 60 Hz).

AC rated capacitors complying with clause 1 of “Electrical Appliance and Material Safety Law”. And not complying with clause 2 of “Electrical Appliance and Material Safety Law”, in this case please use ECQUA type or ECQUL type.

Rating · Dimensions · Quantity

■ Rated voltage [DC] : 1250 V、125 V [AC]*1, Capacitance tolerance : ±5 %(J), ±10 %(K)

Part No.	Cap. (μF)	Dimensions (mm)								Min. order Q'ty (PCS)				
		L max.	T max.	H max.		F		S		G max.	ød	Taping	Bulk	
				Straight	Crimped lead	Straight	Crimped lead	Straight	Crimped lead			Odd size 7.5 mm	Straight	Crimped lead
<small>NRFND</small> ECQE12102□F()	0.0010	15.5	6.0	11.0	16.0	12.5	10.0	1.0	0.6	500	500	500		
<small>NRFND</small> ECQE12122□F()	0.0012	15.5	6.0	11.0	16.0	12.5	10.0	1.0	0.6					
<small>NRFND</small> ECQE12152□F()	0.0015	15.5	6.0	11.0	16.0	12.5	10.0	1.0	0.6					
<small>NRFND</small> ECQE12182□F()	0.0018	15.5	6.0	11.0	16.0	12.5	10.0	1.0	0.6					
<small>NRFND</small> ECQE12222□F()	0.0022	15.5	6.0	11.5	16.5	12.5	10.0	1.0	0.6					
<small>NRFND</small> ECQE12272□F()	0.0027	15.5	6.5	12.0	17.0	12.5	10.0	1.0	0.6					
ECQE12332□F()	0.0033	15.5	6.0	11.5	16.5	12.5	10.0	1.0	0.6	400	500	500		
ECQE12392□F()	0.0039	15.5	6.5	12.0	17.0	12.5	10.0	1.0	0.6					
ECQE12472□F()	0.0047	15.5	7.0	12.5	17.5	12.5	10.0	1.0	0.6	500	500	500		
ECQE12562□F()	0.0056	15.5	7.5	13.0	18.0	12.5	10.0	1.0	0.6					
ECQE12682□F()	0.0068	15.5	7.5	15.0	20.0	12.5	10.0	1.0	0.6					
ECQE12822□F()	0.0082	21.0	5.0	12.0	17.0	17.5	12.5	1.0	0.6	500	500	500		
ECQE12103□F()	0.010	21.0	5.0	12.5	17.5	17.5	12.5	1.0	0.6					
ECQE12123□F()	0.012	21.0	5.5	13.0	18.0	17.5	12.5	1.0	0.6					
ECQE12153□F()	0.015	21.0	6.0	13.5	18.5	17.5	12.5	1.0	0.6					
ECQE12183□F()	0.018	21.0	6.5	14.5	19.5	17.5	12.5	1.0	0.8					
ECQE12223□F()	0.022	21.0	7.0	15.0	20.0	17.5	12.5	1.0	0.8					
ECQE12273□F()	0.027	26.0	6.0	15.5	20.5	22.5	17.5	1.0	0.8	-	-	-		
ECQE12333□F()	0.033	26.0	6.5	16.0	21.0	22.5	17.5	1.0	0.8					
ECQE12393□F()	0.039	26.0	7.0	16.5	21.5	22.5	17.5	1.0	0.8					
ECQE12473□F()	0.047	26.0	8.0	17.0	22.0	22.5	17.5	1.0	0.8					
ECQE12563□F()	0.056	31.0	7.5	17.0	22.0	27.5	22.5	1.0	0.8					
ECQE12683□F()	0.068	31.0	8.0	17.5	22.5	27.5	22.5	1.0	0.8					
ECQE12823□F()	0.082	31.0	9.0	18.5	23.5	27.5	22.5	1.0	0.8					
ECQE12104□F()	0.10	31.0	10.0	19.5	24.5	27.5	22.5	1.0	0.8					
ECQE12124□F()	0.12	31.0	11.5	20.5	25.5	27.5	22.5	1.5	0.8					
ECQE12154□F()	0.15	31.0	12.0	23.0	28.0	27.5	22.5	1.5	0.8					
ECQE12184□F()	0.18	31.0	13.0	24.5	29.5	27.5	22.5	1.5	0.8					
ECQE12224□F()	0.22	31.0	14.5	26.5	31.5	27.5	22.5	1.5	0.8				400	

NRFND Not recommended for new design

* □ : Capacitance tolerance code
 () : Suffix for lead crimped or taped type

Type D : 0.0010 μF to 0.0068 μF
 Type B : 0.0082 μF to 0.22 μF

*1 : This type has two rated voltage, one is DC rated voltage another is AC rated voltage.
 DC rated voltage is 1250 V [DC], AC rated voltage is 125 V [AC].
 Making for rated voltage is "1250 V, 125 V~"

When capacitors use in secondary side of power source, and in case of applying voltage in altering current (50 Hz or 60 Hz sine wave) to a capacitor, please refer to the page of "Permissible voltage (R.M.S) in altering current corresponding to DC rated voltage".

When capacitors use in primary side of power source, the rated voltage is shown 125 V [AC]. Voltage to be applied to capacitors in only sine wave (50 Hz or 60 Hz).

AC rated capacitors complying with clause 1 of "Electrical Appliance and Material Safety Law". And not complying with clause 2 of "Electrical Appliance and Material Safety Law", in this case please use ECQUA type or ECQUL type.

Rating · Dimensions · Quantity

- Rated voltage [AC] : 125 V, Capacitance tolerance : ±5 %(J), ±10 %(K)
Noise suppression Capacitors (Across-the-line)

Part No.	Cap. (μF)	Dimensions (mm)								Min. order Q'ty (PCS)					
		L max.	T max.	H max.		F		S		G max.	ød	Taping			Bulk
				Straight	Crimped lead	Straight	Crimped lead	Straight	Crimped lead			Standard 5.0 mm	Odd size 5.0 mm	Odd size 7.5 mm	
ECQE1A103□F()	0.010	10.5	4.5	7.5	12.5	7.5	7.5	1.0	0.6	1000	-	1000	500		
ECQE1A123□F()	0.012	10.5	4.4	7.5	12.5	7.5	7.5	1.0	0.6						
ECQE1A153□F()	0.015	10.5	4.4	7.5	12.5	7.5	7.5	1.0	0.6						
ECQE1A183□F()	0.018	10.5	4.4	7.5	12.5	7.5	7.5	1.0	0.6						
ECQE1A223□F()	0.022	10.5	4.4	7.5	12.5	7.5	7.5	1.0	0.6						
ECQE1A273□F()	0.027	10.5	4.4	7.5	12.5	7.5	7.5	1.0	0.6						
ECQE1A333□F()	0.033	10.5	4.5	7.8	12.8	7.5	7.5	1.0	0.6						
ECQE1A393□F()	0.039	10.5	4.5	7.8	12.8	7.5	7.5	1.0	0.6						
ECQE1A473□F()	0.047	10.5	5.5	8.0	13.0	7.5	7.5	1.0	0.6	500					
ECQE1A563□F()	0.056	10.5	5.9	8.5	13.5	7.5	7.5	1.0	0.6						
ECQE1A683□F()	0.068	10.5	6.3	9.4	14.4	7.5	7.5	1.0	0.6						

* □ : Capacitance tolerance code
() : Suffix for lead crimped or taped type

Type D : 0.010 μF to 0.068 μF

Notice for AC rated

AC rated capacitors complying with clause 1 of "Electrical Appliance and Material Safety Law".

As for clause 2 of "Electrical Appliance and Material Safety Law", please use ECQUA type or ECQUL type.

When using these capacitors as a across-the-line capacitor, it shall be required to follow either item 1. or item 2. condition.

1. Capacitor shall be connected in parallel with varistor (Specified varistor voltage in table 1.)
2. Voltage applied for capacitor shall not exceed other than specified in table 1, when using these capacitors

Table 1

Capacitor rated voltage	Varistor voltage	Pulse voltage
125 V [AC]	250 V	250 V _{0-p}

Rating · Dimensions · Quantity

- Rated voltage [AC] : 250 V, Capacitance tolerance : ±5 %(J), ±10 %(K)
Noise suppression Capacitors (Across-the-line)

Part No.	Cap. (μF)	Dimensions (mm)								Min. order Q'ty (PCS)				
		L max.	T max.	H max.		F		S	G max.	ød	Taping			Bulk
				Straight	Crimped lead	Straight	Crimped lead	Straight	Standard 5.0 mm		Odd size 5.0 mm	Odd size 7.5 mm		
ECQE2A103□F()	0.010	12.5	5.5	10.8	15.8	10.0	10.0	1.0	0.6	500	1000			
ECQE2A123□F()	0.012	12.5	6.0	11.5	16.5	10.0	10.0	1.0	0.6					
ECQE2A153□F()	0.015	12.5	6.3	9.9	14.9	10.0	10.0	1.0	0.6					
ECQE2A183□F()	0.018	12.5	6.0	11.9	16.9	10.0	10.0	1.0	0.6					
ECQE2A223□F()	0.022	12.5	6.0	11.5	16.5	10.0	10.0	1.0	0.6					
ECQE2A273□F()	0.027	12.5	5.5	10.9	15.9	10.0	10.0	1.0	0.6					
ECQE2A333□F()	0.033	12.5	6.0	11.9	16.9	10.0	10.0	1.0	0.6					
ECQE2A393□F()	0.039	12.5	6.0	13.4	18.4	10.0	10.0	1.0	0.6					
ECQE2A473□F()	0.047	12.5	6.5	14.4	19.4	10.0	10.0	1.0	0.6					
ECQE2A563□F()	0.056	18.5	5.4	10.5	15.5	15.0	10.0	1.0	0.6					
ECQE2A683□F()	0.068	18.5	5.8	11.0	16.0	15.0	10.0	1.0	0.6					
ECQE2A823□F()	0.082	18.5	6.3	12.0	17.0	15.0	10.0	1.0	0.6					
ECQE2A104□F()	0.10	18.5	6.3	14.0	19.0	15.0	10.0	1.0	0.6					
ECQE2A124□F()	0.12	18.5	6.8	14.5	19.5	15.0	10.0	1.0	0.8					
ECQE2A154□F()	0.15	18.5	7.5	15.4	20.4	15.0	10.0	1.0	0.8					
ECQE2A184□F()	0.18	18.5	8.0	16.0	21.0	15.0	10.0	1.0	0.8					
ECQE2A224□F()	0.22	18.5	9.0	16.9	21.9	15.0	10.0	1.0	0.8					
ECQE2A274□F()	0.27	26.0	7.0	16.5	21.5	22.5	15.0	1.0	0.8					
ECQE2A334□F()	0.33	26.0	7.8	17.0	22.0	22.5	15.0	1.0	0.8					
ECQE2A394□F()	0.39	26.0	8.5	17.9	22.9	22.5	15.0	1.0	0.8					
ECQE2A474□F()	0.47	26.0	9.3	18.5	23.5	22.5	15.0	1.0	0.8					
ECQE2A564P()()	0.56	26.0	10.0	20.0	—	22.5	—	1.0	0.8					
ECQE2A684P()()	0.68	26.0	11.5	21.0	—	22.5	—	1.0	0.8					
ECQE2A824P()()	0.82	26.0	13.0	22.5	—	22.5	—	1.0	0.8					
ECQE2A105P()()	1.0	31.0	12.5	21.9	—	27.5	—	1.5	0.8					
ECQE2A125P()()	1.2	31.0	13.5	23.0	—	27.5	—	1.5	0.8					
ECQE2A155P()()	1.5	31.0	15.3	24.7	—	27.5	—	1.5	0.8					
ECQE2A185P()()	1.8	31.0	16.8	27.0	—	27.5	—	1.5	0.8					
ECQE2A225P()()	2.2	31.0	19.5	29.0	—	27.5	—	1.5	0.8					

* □ : Capacitance tolerance code

() : Suffix for lead crimped or taped type

P() : Please contact us about special part number.

* Please consult us about Crimped lead type of 0.56 μF to 2.2 μF.

Type D : 0.010 μF ~ 0.047 μF

Type B : 0.056 μF ~ 0.47 μF

Notice for AC rated

AC rated capacitors complying with clause 1 of "Electrical Appliance and Material Safety Law".

As for clause 2 of "Electrical Appliance and Material Safety Law", please use ECQUA type or ECQUL type.

When using these capacitors as a across-the-line capacitor, it shall be required to follow either item 1. or item 2. condition.

1. Capacitor shall be connected in parallel with varistor (Specified varistor voltage in table 1.)
2. Voltage applied for capacitor shall not exceed other than specified in table 1, when using these capacitors

Table 1

Capacitor rated voltage	Varistor voltage	Pulse voltage
250 V [AC]	470 V	630 V _{0-p}

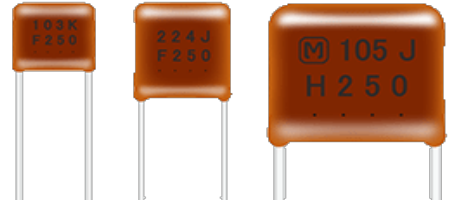

Plastic Film Capacitors

Metallized Polyester Film Capacitor

ECQE(B) series

Non-inductive construction using metallized polyester film with flame retardant epoxy resin coating

Features

- Self-healing property
- Small size
- Excellent electrical characteristics
- Flame retardant epoxy resin coating
- RoHS compliant

Recommended applications

- General purpose usage
※Please contact us when applications are CDI , ignitor etc.

Explanation of part number

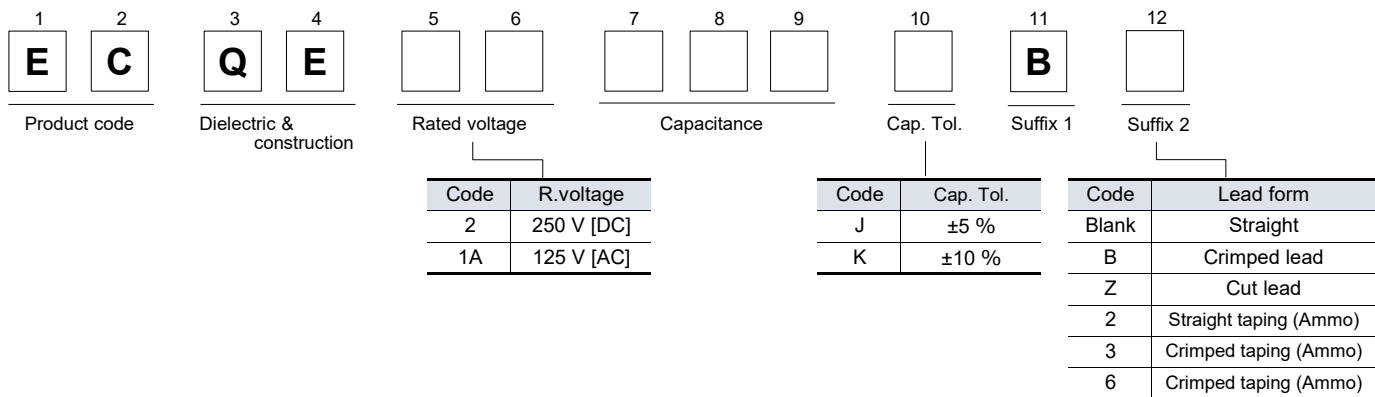

- Odd size taping

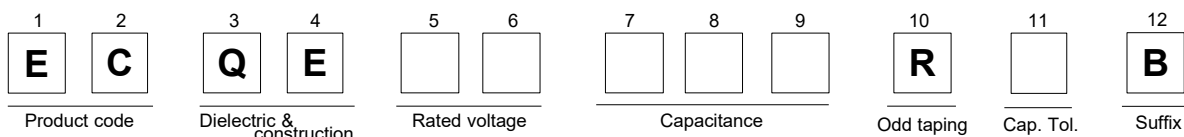

Specifications

Category temp. range (Including temperature-rise on unit surface)	250 V [DC]	-40 °C to +105 °C
	125 V [AC]	
Rated voltage	250 V [DC], 125 V [AC] (250 V [DC] : Derating of rated voltage by 1.25 % / °C at more than 85 °C)	
Capacitance range	250 V [DC]	0.010 μF to 4.7 μF (E12)
	125 V [AC]	0.010 μF to 4.7 μF (E12)
Capacitance tolerance	±5 % (J), ±10 % (K)	
Dissipation factor (tan δ)	tan δ ≤ 1.0 % (20 °C, 1 kHz)	
Withstand voltage	250 V [DC]	Between terminals : Rated voltage (V) × 150 %, 60 s
	125 V [AC]	Between terminals : Rated voltage (V) × 230 %, 60 s Between terminals to enclosure : 1500 V [AC], 60 s
Insulation resistance (IR)	250 V [DC]	C ≤ 0.33 μF : IR ≥ 9000 MΩ (20 °C, 100 V [DC], 60 s)
		C > 0.33 μF : IR ≥ 3000 MΩ · μF (20 °C, 100 V [DC], 60 s)
	125 V [AC]	C ≤ 0.47 μF : IR ≥ 2000 MΩ (20 °C, 500 V [DC], 60 s)
		C > 0.47 μF : IR ≥ 3000 MΩ · μF (20 °C, 100 V [DC], 60 s)

* In case of applying voltage in alternating current (50 Hz or 60 Hz sine wave) to a capacitor with DC rated voltage, please refer to the page of "Permissible voltage (R.M.S) in alternating current corresponding to DC rated voltage".
* Voltage to be applied to ECQE1A (B) is only sine wave (50 Hz or 60 Hz).

Dimensions

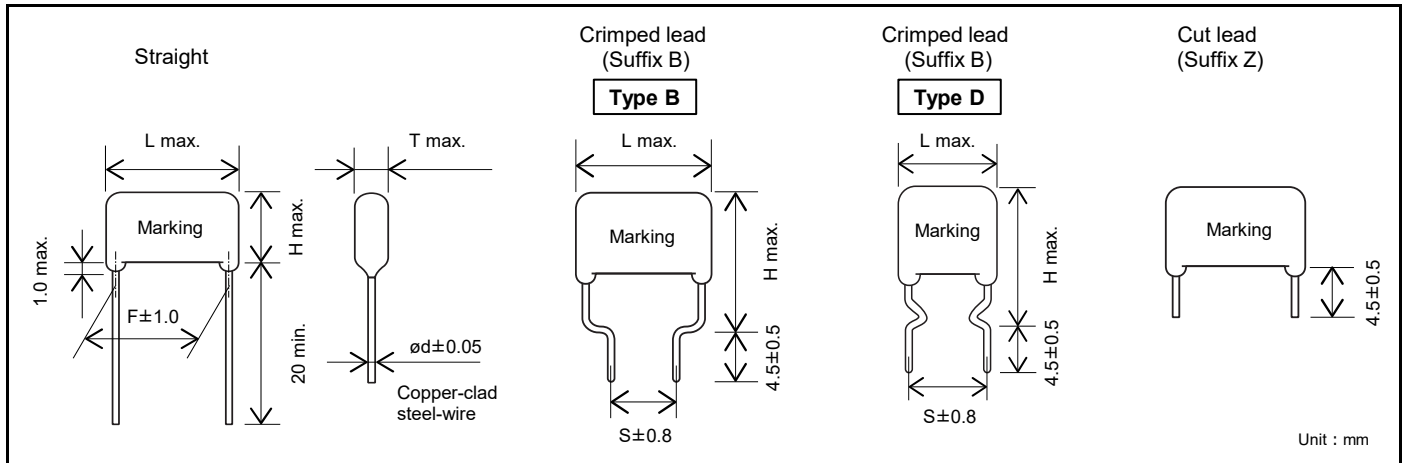

Packaging specifications for bulk package

- Packing quantity : 100 pcs./bag

Taping specifications for automatic insertion

- Taping style

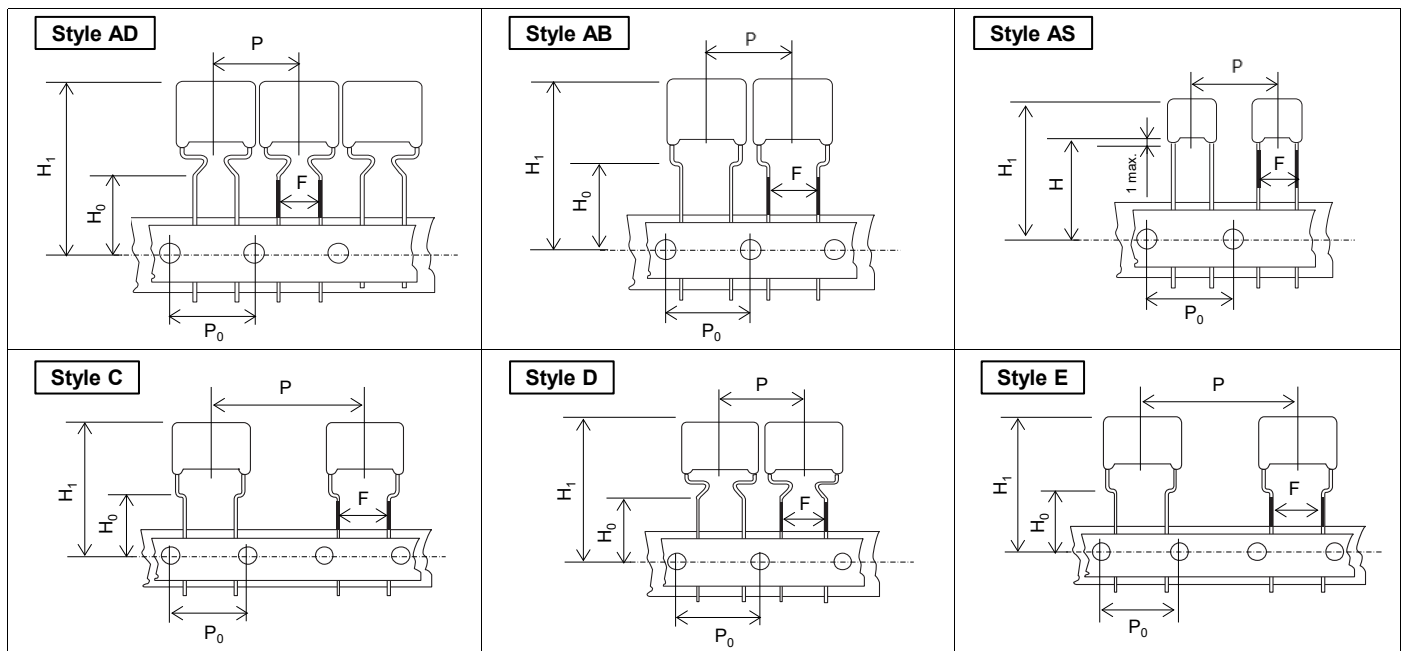

* Please check the product drawing for the shape of the lead wire forming.

The above diagram shows the taping dimensions, and the lead wire forming shape is an example.

* H₁ dimension is based on insertion machine "Panaset RH series" made by Panasonic. Consult with Panasonic technical staff when using other insertion machines.

	Style						Unit : mm
	AD	AB	AS	C	D	E	
P	12.7	12.7	12.7	25.4	15.0	30.0	
P ₀	12.7	12.7	12.7	12.7	15.0	15.0	
F	5.0	5.0	5.0	5.0	7.5	7.5	
H ₀	16.0	16.0	(H)18.0-20.0	16.0	16.0	16.0	
H ₁ *	34.0	34.0	34.0	39.0	44.0	44.0	*.max.

- Packaging specifications

Series	R.voltage	Capacitance range (µF)	Taping style					Packing	Suffix
			AD	AB	B	C	D		
ECQE(B)	250 V [DC]	0.010 to 0.15			○			Ammo	() B2
		0.010 to 0.68	○					Ammo	() B3
		0.82 to 1.5				○		Ammo	() B3
		0.18 to 0.68					○		Ammo
	125 V [AC]	0.82 to 4.7						Ammo	R() B
		0.010 to 0.068			○			Ammo	() B2
		0.082 to 0.22		○				Ammo	() B6
		0.27 to 2.7				○		Ammo	() B3
		0.082 to 0.68				○	Ammo	R() B	
		0.82 to 2.7					○	Ammo	R() B

- Lead spacing

Style	Lead spacing
AD	5.0
AB	5.0
AS	5.0
C	5.0
D	7.5
E	7.5

Unit : mm
See the column "Rating · Dimensions · Quantity" for packaging quantity

Rating · Dimensions · Quantity

■ Rated voltage [DC] : 250 V, Capacitance tolerance : ±5 %(J), ±10 %(K)

Part No.	Cap. (μF)	Dimensions (mm)							Min. order Q'ty (PCS)									
		L max.	T max.	H max.		F	S	ød	Taping			Bulk						
				Straight	Crimped lead	Straight	Crimped lead		Standard 5.0 mm	Odd size 5.0 mm	Odd size 7.5 mm	Straight- Crimped lead						
ECQE2103□B()	0.010	7.9	4.2	7.1	12.1	5.0	5.0	0.5	2000									
ECQE2123□B()	0.012	7.9	4.2	7.1	12.1	5.0	5.0	0.5										
ECQE2153□B()	0.015	7.9	4.2	7.1	12.1	5.0	5.0	0.5										
ECQE2183□B()	0.018	7.9	4.3	7.2	12.2	5.0	5.0	0.5										
ECQE2223□B()	0.022	7.9	4.3	7.2	12.2	5.0	5.0	0.5										
ECQE2273□B()	0.027	7.9	4.3	7.2	12.2	5.0	5.0	0.5										
ECQE2333□B()	0.033	7.9	4.3	7.2	12.2	5.0	5.0	0.5										
ECQE2393□B()	0.039	7.9	4.5	7.4	12.4	5.0	5.0	0.5	1500									
ECQE2473□B()	0.047	7.9	4.5	7.4	12.4	5.0	5.0	0.5										
ECQE2563□B()	0.056	7.9	4.7	7.7	12.7	5.0	5.0	0.5										
ECQE2683□B()	0.068	7.9	5.1	8.0	13.0	5.0	5.0	0.5										
ECQE2823□B()	0.082	7.9	5.4	8.6	13.6	5.0	5.0	0.5	1000									
ECQE2104□B()	0.10	7.9	5.9	9.0	14.0	5.0	5.0	0.5										
ECQE2124□B()	0.12	7.9	5.7	10.6	15.6	5.0	5.0	0.5										
ECQE2154□B()	0.15	7.9	6.3	11.2	16.2	5.0	5.0	0.5										
ECQE2184□B()	0.18	10.3	5.0	9.7	14.7	7.5	5.0	0.5						1500				1500
ECQE2224□B()	0.22	10.3	5.4	10.1	15.1	7.5	5.0	0.5										
ECQE2274□B()	0.27	10.3	5.9	10.8	15.8	7.5	5.0	0.5						1000				1000
ECQE2334□B()	0.33	10.3	6.4	11.3	16.3	7.5	5.0	0.5										
ECQE2394□B()	0.39	12.3	5.7	10.9	15.9	10.0	5.0	0.6										
ECQE2474□B()	0.47	12.3	6.2	11.4	16.4	10.0	5.0	0.6										
ECQE2564□B()	0.56	12.3	6.7	11.9	16.9	10.0	5.0	0.6										
ECQE2684□B()	0.68	12.3	7.3	12.7	17.7	10.0	5.0	0.6										
ECQE2824□B()	0.82	15.3	6.3	13.3	18.3	12.5	5.0	0.6	-				600	500				
ECQE2105□B()	1.0	15.3	7.0	14.0	19.0	12.5	5.0	0.6					500	400				
ECQE2125□B()	1.2	15.3	7.6	14.6	19.6	12.5	5.0	0.6					400	300				
ECQE2155□B()	1.5	15.3	8.6	15.7	20.7	12.5	5.0	0.6					400					
ECQE2185□B()	1.8	20.8	7.6	14.6	19.6	17.5	10.0	0.8										
ECQE2225□B()	2.2	20.8	8.4	15.6	20.6	17.5	10.0	0.8										
ECQE2275□B()	2.7	20.8	9.3	16.7	21.7	17.5	10.0	0.8										
ECQE2335□B()	3.3	20.8	10.5	17.9	22.9	17.5	10.0	0.8					-				300	
ECQE2395□B()	3.9	20.8	10.8	19.8	24.8	17.5	10.0	0.8										
ECQE2475□B()	4.7	20.8	11.9	21.0	26.0	17.5	10.0	0.8										200

* □ : Capacitance tolerance code
 () : Suffix for lead crimped or taped type

Type D : 0.010 μF to 0.68 μF
 Type B : 0.82 μF to 4.7 μF

Rating · Dimensions · Quantity

■ Rated voltage [AC] : 125 V, Capacitance tolerance : ±5 %(J), ±10 %(K)

Part No.	Cap. (μF)	Dimensions (mm)							Min. order Q'ty (PCS)				
		L max.	T max.	H max.		F		S	ød	Taping			Bulk
				Straight	Crimped lead	Straight	Crimped lead	Standard 5.0 mm		Odd size 5.0 mm	Odd size 7.5 mm	Straight- Crimped lead	
ECQE1A103□B()	0.010	7.9	4.2	7.1	-	5.0	-	0.5	2000	-	-	500	
ECQE1A123□B()	0.012	7.9	4.2	7.1		5.0		0.5					
ECQE1A153□B()	0.015	7.9	4.2	7.1		5.0		0.5					
ECQE1A183□B()	0.018	7.9	4.3	7.2		5.0		0.5					
ECQE1A223□B()	0.022	7.9	4.3	7.2		5.0		0.5					
ECQE1A273□B()	0.027	7.9	4.3	7.2		5.0		0.5					
ECQE1A333□B()	0.033	7.9	4.3	7.2		5.0		0.5					
ECQE1A393□B()	0.039	7.9	4.5	7.4		5.0		0.5					
ECQE1A473□B()	0.047	7.9	4.8	7.7		5.0		0.5					
ECQE1A563□B()	0.056	7.9	5.1	8.0		5.0		0.5					
ECQE1A683□B()	0.068	7.9	5.4	8.6	5.0	0.5	1500	-	1500				
ECQE1A823□B()	0.082	10.3	4.6	7.6	12.6	7.5				7.5	0.5		
ECQE1A104□B()	0.10	10.3	5.1	7.7	12.7	7.5				7.5	0.5		
ECQE1A124□B()	0.12	10.3	5.3	8.4	13.4	7.5				7.5	0.5		
ECQE1A154□B()	0.15	10.3	5.7	8.9	13.9	7.5				7.5	0.5		
ECQE1A184□B()	0.18	10.3	5.6	10.3	15.3	7.5				7.5	0.5		
ECQE1A224□B()	0.22	10.3	6.1	11.0	16.0	7.5				7.5	0.5		
ECQE1A274□B()	0.27	12.3	5.4	10.7	15.7	10.0				7.5	0.6		
ECQE1A334□B()	0.33	12.3	5.9	11.2	16.2	10.0				7.5	0.6		
ECQE1A394□B()	0.39	12.3	6.4	11.6	16.6	10.0				7.5	0.6		
ECQE1A474□B()	0.47	12.3	7.0	12.2	17.2	10.0	7.5	0.6					
ECQE1A564□B()	0.56	12.3	6.7	11.9	16.9	10.0	7.5	0.6					
ECQE1A684□B()	0.68	12.3	7.3	12.7	17.7	10.0	7.5	0.6					
ECQE1A824□B()	0.82	15.3	6.3	13.3	18.3	12.5	7.5	0.6					
ECQE1A105□B()	1.0	15.3	7.0	14.0	19.0	12.5	7.5	0.6					
ECQE1A125□B()	1.2	20.8	7.1	14.1	19.1	17.5	10.0	0.8					
ECQE1A155□B()	1.5	20.8	8.0	15.1	20.1	17.5	10.0	0.8					
ECQE1A185□B()	1.8	20.8	8.7	15.9	20.9	17.5	10.0	0.8					
ECQE1A225□B()	2.2	20.8	9.7	17.1	22.1	17.5	10.0	0.8					
ECQE1A275□B()	2.7	20.8	10.9	18.2	23.2	17.5	10.0	0.8					
ECQE1A335□B()	3.3	25.8	9.6	18.7	23.7	22.5	15.0	0.8					
ECQE1A395□B()	3.9	25.8	10.6	19.7	24.7	22.5	15.0	0.8					
ECQE1A475□B()	4.7	25.8	11.8	20.8	25.8	22.5	15.0	0.8					

* □ : Capacitance tolerance code
 () : Suffix for lead crimped or taped type

Type D : 0.082 μF to 0.68 μF
 Type B : 0.82 μF to 4.7 μF

Notice for AC rated

AC rated capacitors complying with clause 1 of “Electrical Appliance and Material Safety Law”.

As for clause 2 of “Electrical Appliance and Material Safety Law”, please use ECQUA type or ECQUL type.

When using these capacitors as a across-the-line capacitor, it shall be required to follow either item 1. or item 2. condition.

1. Capacitor shall be connected in parallel with varistor (Specified varistor voltage in table 1.)
2. Voltage applied for capacitor shall not exceed other than specified in table 1, when using these capacitors

Table 1

Capacitor rated voltage	Varistor voltage	Pulse voltage
125 V [AC]	250 V	250 V _{0-p}

Plastic Film Capacitors

Metallized Polyester Film Capacitor

ECQE(T) series

Non-inductive construction using metallized polyester film with flame retardant epoxy resin coating



Features

- Self-healing property
- Excellent electrical characteristics
- Flame retardant epoxy resin coating
- Moisture resistance 85 °C, 85 % RH for 500 hours
- RoHS compliant

Recommended applications

- General purpose usage
 ※Please contact us when applications are CDI , ignitor etc.

Explanation of part number

1	2	3	4	5	6	7	8	9	10	11	12
E	C	Q	E							T	
Product code		Dielectric & construction		Rated voltage		Capacitance			Cap. Tol.	Suffix 1	Suffix 2

Code	R.voltage
2	250 V [DC]
4	400 V [DC]
6	630 V [DC]
1A	125 V [AC]
2A	250 V [AC]

Code	Cap. Tol.
J	±5 %
K	±10 %

Code	Lead form
Blank	Straight
B	Crimped lead
Z	Cut lead
3	Crimped taping (Ammo)
6	Crimped taping (Ammo)

- Odd size taping

1	2	3	4	5	6	7	8	9	10	11	12
E	C	Q	E						R		T
Product code		Dielectric & construction		Rated voltage		Capacitance			Odd taping	Cap. Tol.	Suffix

Specifications

Category temp. range (Including temperature-rise on unit surface)	250 V to 630 V [DC]	-40 °C to +105 °C
	125 V, 250 V [AC]	-40 °C to +105 °C
Rated voltage	250 V, 400 V, 630 V [DC] (Derating of rated voltage by 1.25 %/°C at more than 85 °C) 125 V, 250 V [AC]	
Capacitance range	250 V [DC]	0.010 μF ~ 10.0 μF (E12)
	400 V [DC]	0.010 μF ~ 2.2 μF (E12)
	630 V [DC]	0.010 μF ~ 2.2 μF (E12)
	125 V [AC]	0.010 μF ~ 0.47 μF (E12)
	250 V [AC]	0.010 μF ~ 0.47 μF (E12)
Capacitance tolerance	±5 % (J), ±10 % (K)	
Dissipation factor (tan δ)	tan δ ≤ 1.0 % (20 °C, 1 kHz)	
Withstand voltage	250 V to 630 V [DC]	Between terminals : R.voltage (V) × 150 %, 60 s
	125 V [AC] 250 V [AC]	Between terminals : R.voltage (V) × 230 %, 60 s Between terminals to enclosure : 1500 V [AC], 60 s
Insulation resistance (IR)	250V to 630V [DC]	C ≤ 0.33 μF : IR ≥ 9000 MΩ (20 °C, 100 V [DC], 60 s)
		C > 0.33 μF : IR ≥ 3000 MΩ · μF (20 °C, 100 V [DC], 60 s)
	125 V [AC] 250 V [AC]	IR ≥ 2000 MΩ (20 °C, 500 V [DC], 60 s)

- * In case of applying voltage in alternating current (50 Hz or 60 Hz sine wave) to a capacitor with DC rated voltage, please refer to the page of "Permissible voltage (R.M.S) in alternating current corresponding to DC rated voltage".
- * Voltage to be applied to ECQE1A (F) & ECQE2A (F) is only sine wave (50 Hz or 60 Hz).

Dimensions

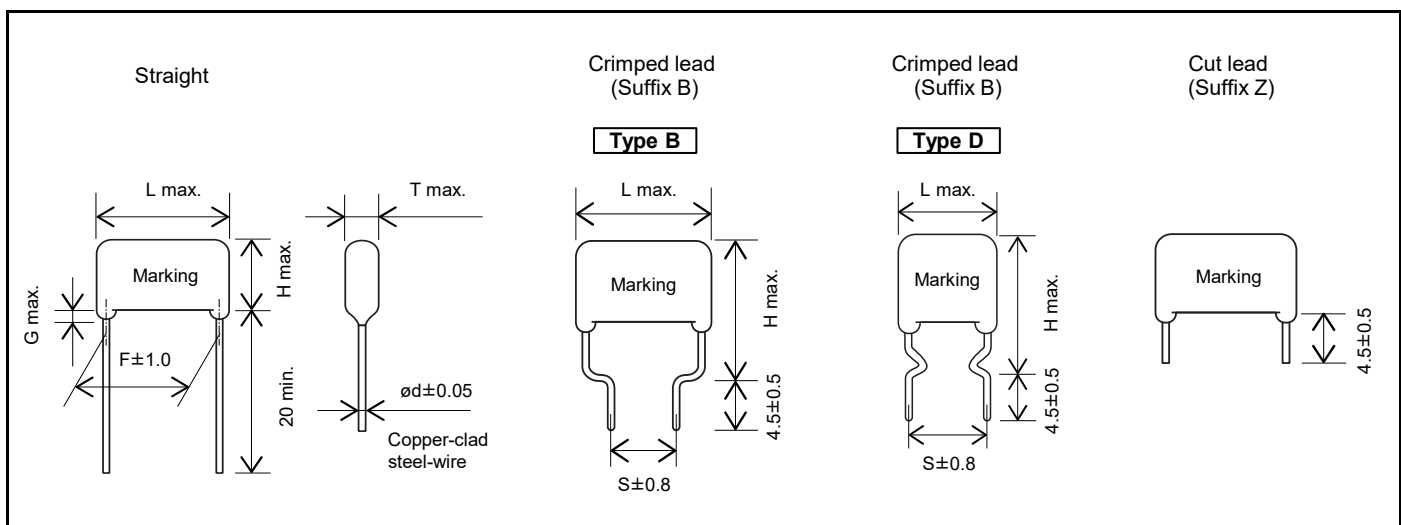

Packaging specifications for bulk package

- Packing quantity : 100 pcs./bag

Taping specifications for automatic insertion

■ Taping style

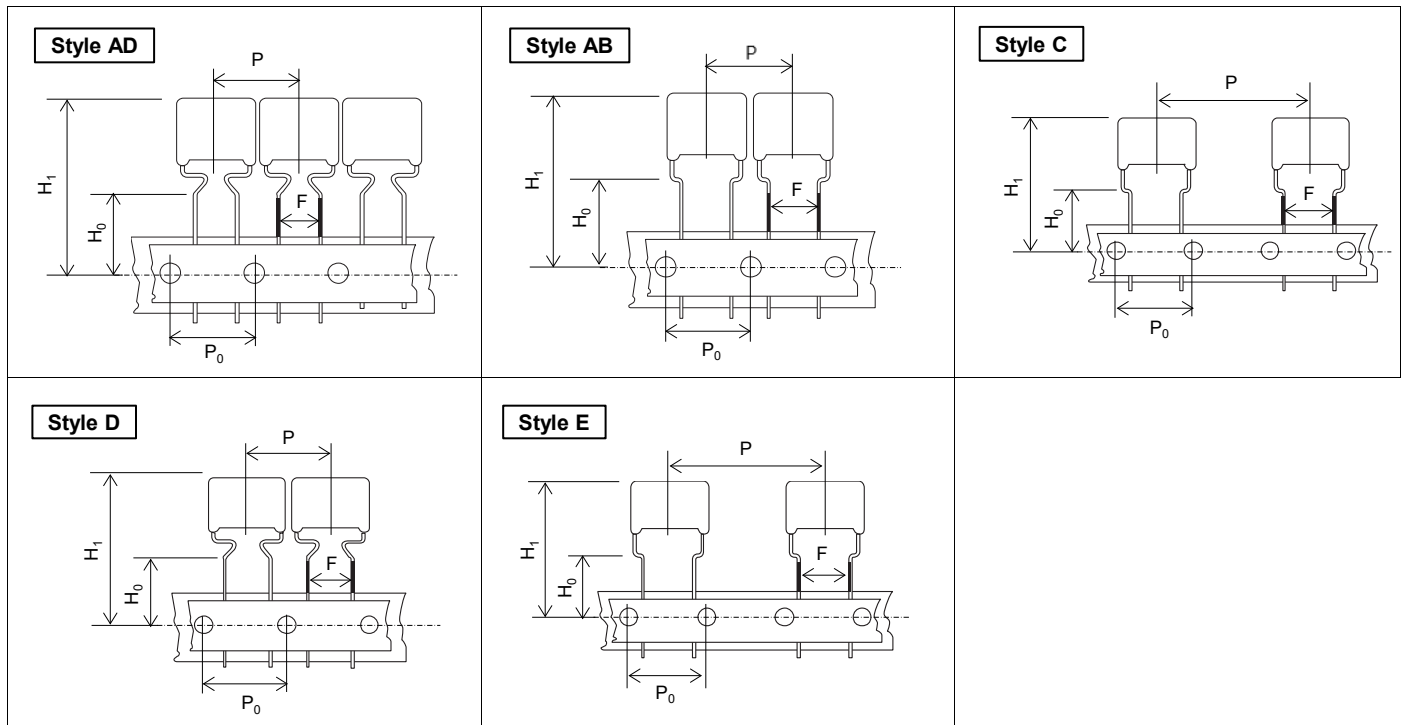

* Please check the product drawing for the shape of the lead wire forming.
 The above diagram shows the taping dimensions, and the lead wire forming shape is an example.
 * H₁ dimension is based on insertion machine "Panaset RH series" made by Panasonic. Consult with Panasonic technical staff when using other insertion machines.

Size list Unit : mm

	Style				
	AD	AB	C	D	E
P	12.7	12.7	25.4	15.0	30.0
P ₀	12.7	12.7	12.7	15.0	15.0
F	5.0	5.0	5.0	7.5	7.5
H ₀	16.0	16.0	16.0	16.0	16.0
H ₁ *	34.0	34.0	39.0	44.0	44.0

*:max.

■ Packaging specifications

Series	R.voltage	Capacitance range (μF)	Taping style					Packing	Suffix
			AD	AB	C	D	E		
ECQE(T)	250 V [DC]	0.010 to 0.15	○					Ammo	() T3
		0.18 to 0.33			○			Ammo	() T3
		0.39 to 1.5			○			Ammo	() T3
		0.010 to 0.33				○		Ammo	R() T
		0.39 to 1.5					○	Ammo	R() T
	400 V [DC]	0.010 to 0.033	○					Ammo	() T3
		0.039 to 0.10			○			Ammo	() T3
		0.12 to 0.47			○			Ammo	() T3
		0.010 to 0.10				○		Ammo	R() T
		0.12 to 0.47					○	Ammo	R() T
	630 V [DC]	0.010 to 0.047			○			Ammo	() T3
		0.056 to 0.22			○			Ammo	() T3
		0.010 to 0.047				○		Ammo	R() T
		0.056 to 0.22					○	Ammo	R() T
	125 V [AC]	0.27 to 0.47			○			Ammo	() T3
		0.010 to 0.10		○				Ammo	() T6
0.12 to 0.22				○			Ammo	() T6	
0.010 to 0.22					○		Ammo	R() T	
250 V [AC]	0.27 to 0.47					○	Ammo	R() T	
	0.056 to 0.22			○		○	Ammo	() T3	
	0.010 to 0.047			○			Ammo	() T6	
	0.010 to 0.047				○		Ammo	R() T	
		0.056 to 0.22				○	Ammo	R() T	

● Lead spacing

Style	Lead spacing
AD	5.0
AB	5.0
C	5.0
D	7.5
E	7.5

Unit : mm

See the column "Rating · Dimensions · Quantity" for packaging quantity

Design and specifications are each subject to change without notice. Ask factory for the current technical specifications before purchase and/or use.
 Should a safety concern arise regarding this product, please be sure to contact us immediately.

Rating · Dimensions · Quantity

■ Rated voltage [DC] : 250 V, Capacitance tolerance : ±5 %(J), ±10 %(K)

Part No.	Cap. (μF)	Dimensions (mm)								Min. order Q'ty (PCS)							
		L max.	T max.	H max.		F		S		G max.	ød	Taping			Bulk		
				Straight	Crimped lead	Straight	Crimped lead	Straight	Crimped lead			Standard 5.0 mm	Odd size 5.0 mm	Odd size 7.5 mm	Straight	Crimped lead	
ECQE2103□T()	0.010	10.8	4.3	7.4	12.4	7.5	7.5	1.0	0.6	1500	-	1800	500	500			
ECQE2123□T()	0.012	10.8	4.4	7.5	12.5	7.5	7.5	1.0	0.6								
ECQE2153□T()	0.015	10.8	4.4	7.5	12.5	7.5	7.5	1.0	0.6								
ECQE2183□T()	0.018	10.8	4.4	7.5	12.5	7.5	7.5	1.0	0.6								
ECQE2223□T()	0.022	10.8	4.4	7.5	12.5	7.5	7.5	1.0	0.6								
ECQE2273□T()	0.027	10.8	4.4	7.5	12.5	7.5	7.5	1.0	0.6								
ECQE2333□T()	0.033	10.8	4.5	7.5	12.5	7.5	7.5	1.0	0.6								
ECQE2393□T()	0.039	10.8	4.5	7.5	12.5	7.5	7.5	1.0	0.6								
ECQE2473□T()	0.047	10.8	4.5	7.5	12.5	7.5	7.5	1.0	0.6								
ECQE2563□T()	0.056	10.8	4.8	7.9	12.9	7.5	7.5	1.0	0.6								
ECQE2683□T()	0.068	10.8	4.5	7.5	12.5	7.5	7.5	1.0	0.6								
ECQE2823□T()	0.082	10.8	4.9	8.0	13.0	7.5	7.5	1.0	0.6								
ECQE2104□T()	0.10	10.8	5.8	8.4	13.4	7.5	7.5	1.0	0.6	1000	-	1300	500	500			
ECQE2124□T()	0.12	10.8	6.0	9.0	14.0	7.5	7.5	1.0	0.6								
ECQE2154□T()	0.15	10.8	6.0	10.8	15.8	7.5	7.5	1.0	0.6								
ECQE2184□T()	0.18	12.5	5.0	10.3	15.3	10.0	10.0	1.0	0.6	-	-	800	1400	500	500		
ECQE2224□T()	0.22	12.5	5.5	10.5	15.5	10.0	10.0	1.0	0.6			700	1300				
ECQE2274□T()	0.27	12.5	6.0	11.5	16.5	10.0	10.0	1.0	0.6			600	1200				
ECQE2334□T()	0.33	12.5	6.5	12.0	17.0	10.0	10.0	1.0	0.6			800	1100				
ECQE2394□T()	0.39	19.0	4.9	12.0	17.0	15.0	10.0	1.0	0.6			800	700				
ECQE2474□T()	0.47	19.0	5.3	12.5	17.5	15.0	10.0	1.0	0.6			700	600				
ECQE2564□T()	0.56	19.0	5.5	13.0	18.0	15.0	10.0	1.0	0.6			800					
ECQE2684□T()	0.68	19.0	6.0	13.5	18.5	15.0	10.0	1.0	0.8			700	500				
ECQE2824□T()	0.82	19.0	6.5	14.5	19.5	15.0	10.0	1.0	0.8			600					
ECQE2105□T()	1.0	19.0	7.4	15.0	20.0	15.0	10.0	1.0	0.8			500	400			-	-
ECQE2125□T()	1.2	19.0	8.0	15.9	20.9	15.0	10.0	1.0	0.8								
ECQE2155□T()	1.5	19.0	9.0	16.8	21.8	15.0	10.0	1.0	0.8			400					
ECQE2185□T()	1.8	26.5	7.5	15.5	20.5	22.5	15.0	1.0	0.8	-	-						
ECQE2225□T()	2.2	26.5	8.5	16.3	21.3	22.5	15.0	1.0	0.8								
ECQE2275□T()	2.7	26.5	9.4	17.0	22.0	22.5	15.0	1.0	0.8								
ECQE2335□T()	3.3	26.5	10.3	18.0	23.0	22.5	15.0	1.5	0.8								
ECQE2395□T()	3.9	26.5	11.0	20.5	25.5	22.5	15.0	1.5	0.8								
ECQE2475□T()	4.7	26.5	12.0	21.5	26.5	22.5	15.0	1.5	0.8								
ECQE2565□T()	5.6	31.5	11.8	21.0	26.0	27.5	22.5	1.5	0.8								
ECQE2685□T()	6.8	31.5	13.0	22.4	27.4	27.5	22.5	1.5	0.8								
ECQE2825□T()	8.2	31.5	14.3	23.5	28.5	27.5	22.5	1.5	0.8			400					
ECQE2106□T()	10.0	31.5	15.9	25.8	30.8	27.5	22.5	1.5	0.8			300	400				

* □ : Capacitance tolerance code
 () : Suffix for lead crimped or taped type

Type D : 0.010 μF to 0.33 μF
 Type B : 0.39 μF to 10.0 μF

Rating · Dimensions · Quantity

■ Rated voltage [DC] : 400 V, Capacitance tolerance : ±5 % (J), ±10 % (K)

Part No.	Cap. (μF)	Dimensions (mm)								Min. order Q'ty (PCS)			
		L max.	T max.	H max.		F	S	G max.	ød	Taping			Bulk
				Straight	Crimped lead					Straight	Crimped lead	Straight	
ECQE4103□T()	0.010	10.8	4.3	7.4	12.4	7.5	7.5	1.0	0.6	1500	-	1800	500
ECQE4123□T()	0.012	10.8	4.4	7.5	12.5	7.5	7.5	1.0	0.6				
ECQE4153□T()	0.015	10.8	4.4	7.5	12.5	7.5	7.5	1.0	0.6				
ECQE4183□T()	0.018	10.8	4.4	7.5	12.5	7.5	7.5	1.0	0.6				
ECQE4223□T()	0.022	10.8	4.8	7.9	12.9	7.5	7.5	1.0	0.6				
ECQE4273□T()	0.027	10.8	5.5	8.0	13.0	7.5	7.5	1.0	0.6				
ECQE4333□T()	0.033	10.8	6.0	9.0	14.0	7.5	7.5	1.0	0.6	1000	-	1200	500
ECQE4393□T()	0.039	12.5	4.9	8.0	13.0	10.0	10.0	1.0	0.6				
ECQE4473□T()	0.047	12.5	5.0	8.3	13.3	10.0	10.0	1.0	0.6	-	900	1500	500
ECQE4563□T()	0.056	12.5	5.0	10.0	15.0	10.0	10.0	1.0	0.6				
ECQE4683□T()	0.068	12.5	5.4	10.5	15.5	10.0	10.0	1.0	0.6				
ECQE4823□T()	0.082	12.5	5.8	11.0	16.0	10.0	10.0	1.0	0.6				
ECQE4104□T()	0.10	12.5	6.3	12.0	17.0	10.0	10.0	1.0	0.6				
ECQE4124□T()	0.12	19.0	5.0	10.0	15.0	15.0	10.0	1.0	0.6				
ECQE4154□T()	0.15	19.0	5.0	12.4	17.4	15.0	10.0	1.0	0.6				
ECQE4184□T()	0.18	19.0	5.4	12.5	17.5	15.0	10.0	1.0	0.6				
ECQE4224□T()	0.22	19.0	5.9	13.0	18.0	15.0	10.0	1.0	0.6				
ECQE4274□T()	0.27	19.0	6.5	14.3	19.3	15.0	10.0	1.0	0.8				
ECQE4334□T()	0.33	19.0	7.0	14.9	19.9	15.0	10.0	1.0	0.8	-	600	500	500
ECQE4394□T()	0.39	19.0	7.5	15.4	20.4	15.0	10.0	1.0	0.8				
ECQE4474□T()	0.47	19.0	7.8	17.0	22.0	15.0	10.0	1.0	0.8				
ECQE4564□T()	0.56	26.5	6.5	16.0	21.0	22.5	15.0	1.0	0.8				
ECQE4684□T()	0.68	26.5	7.0	16.5	21.5	22.5	15.0	1.0	0.8				
ECQE4824□T()	0.82	26.5	7.9	17.3	22.3	22.5	15.0	1.0	0.8				
ECQE4105□T()	1.0	26.5	8.5	18.0	23.0	22.5	15.0	1.0	0.8				
ECQE4125□T()	1.2	26.5	9.5	18.9	23.9	22.5	15.0	1.0	0.8				
ECQE4155□T()	1.5	31.5	9.5	19.0	24.0	27.5	22.5	1.0	0.8				
ECQE4185□T()	1.8	31.5	11.0	20.5	25.5	27.5	22.5	1.5	0.8				
ECQE4225□T()	2.2	31.5	11.0	22.0	27.0	27.5	22.5	1.5	0.8				

* □ : Capacitance tolerance code
 () : Suffix for lead crimped or taped type

Type D : 0.010 μF to 0.10 μF
 Type B : 0.12 μF to 2.2 μF

■ Rated voltage [DC] : 630 V, Capacitance tolerance : ±5 % (J), ±10 % (K)

Part No.	Cap. (μF)	Dimensions (mm)								Min. order Q'ty (PCS)			
		L max.	T max.	H max.		F	S	G max.	ød	Taping			Bulk
				Straight	Crimped lead					Straight	Crimped lead	Straight	
ECQE6103□T()	0.010	12.5	4.5	7.5	12.5	10.0	10.0	1.0	0.6	900	1600	500	500
ECQE6123□T()	0.012	12.5	4.5	7.8	12.8	10.0	10.0	1.0	0.6				
ECQE6153□T()	0.015	12.5	5.0	8.2	13.2	10.0	10.0	1.0	0.6	800	1400	500	500
ECQE6183□T()	0.018	12.5	4.9	10.0	15.0	10.0	10.0	1.0	0.6				
ECQE6223□T()	0.022	12.5	5.3	10.5	15.5	10.0	10.0	1.0	0.6	-	1300	500	500
ECQE6273□T()	0.027	12.5	5.5	10.9	15.9	10.0	10.0	1.0	0.6				
ECQE6333□T()	0.033	12.5	6.0	11.9	16.9	10.0	10.0	1.0	0.6	700	1200	500	500
ECQE6393□T()	0.039	12.5	6.0	13.4	18.4	10.0	10.0	1.0	0.6				
ECQE6473□T()	0.047	12.5	6.5	13.5	18.5	10.0	10.0	1.0	0.6	600	1100	500	500
ECQE6563□T()	0.056	19.0	5.4	10.5	15.5	15.0	10.0	1.0	0.6	800	600		
ECQE6683□T()	0.068	19.0	5.8	11.0	16.0	15.0	10.0	1.0	0.6	700	600	500	500
ECQE6823□T()	0.082	19.0	6.5	12.0	17.0	15.0	10.0	1.0	0.6				
ECQE6104□T()	0.10	19.0	6.3	14.0	19.0	15.0	10.0	1.0	0.6	600	500	500	500
ECQE6124□T()	0.12	19.0	6.3	14.5	19.5	15.0	10.0	1.0	0.8				
ECQE6154□T()	0.15	19.0	7.5	15.4	20.4	15.0	10.0	1.0	0.8	500	400	500	500
ECQE6184□T()	0.18	19.0	8.0	16.0	21.0	15.0	10.0	1.0	0.8				
ECQE6224□T()	0.22	19.0	9.0	16.5	21.5	15.0	10.0	1.0	0.8	400	-	500	500
ECQE6274□T()	0.27	26.5	7.0	16.5	21.5	22.5	15.0	1.0	0.8				
ECQE6334□T()	0.33	26.5	7.8	17.0	22.0	22.5	15.0	1.0	0.8	-	-	500	500
ECQE6394□T()	0.39	26.5	8.5	17.9	22.9	22.5	15.0	1.0	0.8				
ECQE6474□T()	0.47	26.5	9.3	18.5	23.5	22.5	15.0	1.0	0.8				
ECQE6564□T()	0.56	26.5	10.0	20.0	25.0	22.5	15.0	1.5	0.8				
ECQE6684□T()	0.68	26.5	11.5	21.0	26.0	22.5	15.0	1.5	0.8				
ECQE6824□T()	0.82	31.5	11.3	20.5	25.5	27.5	22.5	1.5	0.8				
ECQE6105□T()	1.0	31.5	12.5	21.9	26.9	27.5	22.5	1.5	0.8				
ECQE6125□T()	1.2	31.5	13.5	23.0	28.0	27.5	22.5	1.5	0.8				
ECQE6155□T()	1.5	31.5	15.3	24.7	29.7	27.5	22.5	1.5	0.8				
ECQE6185□T()	1.8	31.5	16.8	27.0	32.0	27.5	22.5	1.5	0.8				
ECQE6225□T()	2.2	31.5	19.5	29.0	34.0	27.5	22.5	1.5	0.8				

* □ : Capacitance tolerance code
 () : Suffix for lead crimped or taped type

Type D : 0.010 μF to 0.047 μF
 Type B : 0.1056 μF to 2.2 μF

Rating · Dimensions · Quantity

- Rated voltage [AC] : 125 V, Capacitance tolerance : ±5 %(J), ±10 %(K)
Noise suppression Capacitors (Across-the-line)

Part No.	Cap. (μF)	Dimensions (mm)								Min. order Q'ty (PCS)					
		L max.	T max.	H max.		F		S		G max.	ød	Taping			Bulk Straight-Crimped lead
				Straight	Crimped lead	Straight	Crimped lead	Straight	Standard 5.0 mm			Odd size 5.0 mm	Odd size 7.5 mm		
ECQE1A103□T()	0.010	11.0	4.5	7.5	12.5	7.5	7.5	1.0	0.6	1500	-	1700	500		
ECQE1A123□T()	0.012	11.0	4.4	7.5	12.5	7.5	7.5	1.0	0.6						
ECQE1A153□T()	0.015	11.0	4.4	7.5	12.5	7.5	7.5	1.0	0.6						
ECQE1A183□T()	0.018	11.0	4.4	7.5	12.5	7.5	7.5	1.0	0.6						
ECQE1A223□T()	0.022	11.0	4.4	7.5	12.5	7.5	7.5	1.0	0.6						
ECQE1A273□T()	0.027	11.0	4.4	7.5	12.5	7.5	7.5	1.0	0.6						
ECQE1A333□T()	0.033	11.0	4.5	7.8	12.8	7.5	7.5	1.0	0.6						
ECQE1A393□T()	0.039	11.0	4.5	7.8	12.8	7.5	7.5	1.0	0.6						
ECQE1A473□T()	0.047	11.0	5.5	8.0	13.0	7.5	7.5	1.0	0.6						
ECQE1A563□T()	0.056	11.0	5.9	8.5	13.5	7.5	7.5	1.0	0.6						
ECQE1A683□T()	0.068	11.0	6.3	9.4	14.4	7.5	7.5	1.0	0.6						
ECQE1A823□T()	0.082	11.0	6.5	9.8	14.8	7.5	7.5	1.0	0.6						
ECQE1A104□T()	0.10	11.0	6.5	11.8	16.8	7.5	7.5	1.0	0.6						
ECQE1A124□T()	0.12	13.0	5.9	11.5	16.5	10.0	10.0	1.0	0.6						
ECQE1A154□T()	0.15	13.0	6.5	12.0	17.0	10.0	10.0	1.0	0.6						
ECQE1A184□T()	0.18	13.0	7.0	12.5	17.5	10.0	10.0	1.0	0.6						
ECQE1A224□T()	0.22	13.0	7.5	13.4	18.4	10.0	10.0	1.0	0.6						
ECQE1A274□T()	0.27	19.0	6.3	12.0	17.0	15.0	10.0	1.0	0.6						
ECQE1A334□T()	0.33	19.0	6.9	12.5	17.5	15.0	10.0	1.0	0.6						
ECQE1A394□T()	0.39	19.0	7.4	13.0	18.0	15.0	10.0	1.0	0.6						
ECQE1A474□T()	0.47	19.0	7.5	15.3	20.3	15.0	10.0	1.0	0.6						

* □ : Capacitance tolerance code () : Suffix for lead crimped or taped type Type D : 0.010 μF to 0.22 μF Type B : 0.27 μF to 0.47 μF

- Rated voltage [AC] : 250 V, Capacitance tolerance : ±5 %(J), ±10 %(K)
Noise suppression Capacitors (Across-the-line)

Part No.	Cap. (μF)	Dimensions (mm)								Min. order Q'ty (PCS)				
		L max.	T max.	H max.		F		S		G max.	ød	Taping		Bulk Straight-Crimped lead
				Straight	Crimped lead	Straight	Crimped lead	Straight	Odd size 5.0 mm			Odd size 7.5 mm		
ECQE2A103□T()	0.010	13.0	5.5	10.8	15.8	10.0	10.0	1.0	0.6	800	1300	500		
ECQE2A123□T()	0.012	13.0	6.0	11.5	16.5	10.0	10.0	1.0	0.6	700	1200			
ECQE2A153□T()	0.015	13.0	6.3	9.9	14.9	10.0	10.0	1.0	0.6	600	1100			
ECQE2A183□T()	0.018	13.0	6.0	11.9	16.9	10.0	10.0	1.0	0.6	700	1200			
ECQE2A223□T()	0.022	13.0	6.0	11.5	16.5	10.0	10.0	1.0	0.6	800	1300			
ECQE2A273□T()	0.027	13.0	5.5	10.9	15.9	10.0	10.0	1.0	0.6	700	1200			
ECQE2A333□T()	0.033	13.0	6.0	11.9	16.9	10.0	10.0	1.0	0.6	600	1100			
ECQE2A393□T()	0.039	13.0	6.0	13.4	18.4	10.0	10.0	1.0	0.6	800	600			
ECQE2A473□T()	0.047	13.0	6.5	14.4	19.4	10.0	10.0	1.0	0.6	700	600			
ECQE2A563□T()	0.056	19.0	5.4	10.5	15.5	15.0	10.0	1.0	0.6	600	500			
ECQE2A683□T()	0.068	19.0	5.8	11.0	16.0	15.0	10.0	1.0	0.6	500	400			
ECQE2A823□T()	0.082	19.0	6.3	12.0	17.0	15.0	10.0	1.0	0.6	400	400			
ECQE2A104□T()	0.10	19.0	6.3	14.0	19.0	15.0	10.0	1.0	0.8	-	-			
ECQE2A124□T()	0.12	19.0	6.8	14.5	19.5	15.0	10.0	1.0	0.8	-	-			
ECQE2A154□T()	0.15	19.0	7.5	15.4	20.4	15.0	10.0	1.0	0.8	-	-			
ECQE2A184□T()	0.18	19.0	8.0	16.0	21.0	15.0	10.0	1.0	0.8	-	-			
ECQE2A224□T()	0.22	19.0	9.0	16.9	21.9	15.0	10.0	1.0	0.8	-	-			
ECQE2A274□T()	0.27	26.5	7.0	16.5	21.5	22.5	15.0	1.0	0.8	-	-			
ECQE2A334□T()	0.33	26.5	7.8	17.0	22.0	22.5	15.0	1.0	0.8	-	-			
ECQE2A394□T()	0.39	26.5	8.5	17.9	22.9	22.5	15.0	1.0	0.8	-	-			
ECQE2A474□T()	0.47	26.5	9.3	18.5	23.5	22.5	15.0	1.0	0.8	-	-			

* □ : Capacitance tolerance code () : Suffix for lead crimped or taped type Type D : 0.010 μF to 0.047 μF Type B : 0.2056 μF to 0.47 μF

Notice for AC rated

AC rated capacitors complying with clause 1 of "Electrical Appliance and Material Safety Law".

As for clause 2 of "Electrical Appliance and Material Safety Law", please use ECQUA type or ECQL type.

When using these capacitors as a across-the-line capacitor, it shall be required to follow either item 1. or item 2. condition.

1. Capacitor shall be connected in parallel with varistor (Specified varistor voltage in table 1.)
2. Voltage applied for capacitor shall not exceed other than specified in table 1, when using these capacitors

Table 1

Capacitor rated voltage	Varistor voltage	Pulse voltage
125 V [AC]	250 V	250 V _{0-p}
250 V [AC]	470 V	630 V _{0-p}



Plastic Film Capacitors

Metallized Polypropylene Film Capacitor

ECWF(L) series

Non-inductive construction using metallized polypropylene film with flame retardant epoxy resin coating

Features

- Small size
- Excellent frequency characteristics
- Low loss
- Flame retardant epoxy resin coating
- 85 °C, 85 % RH, W.V. × 1.0 for 500 hours
- RoHS compliant

Recommended applications

- Lighting
- High frequency and high current circuit

Explanation of part number

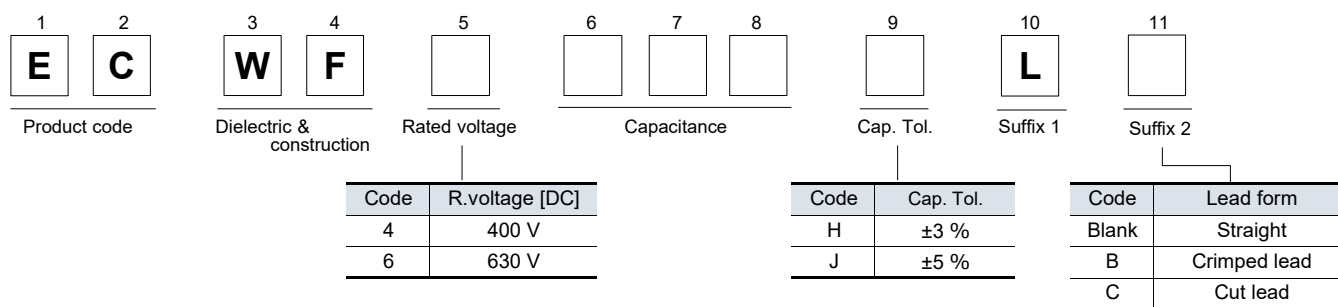

- Odd size taping

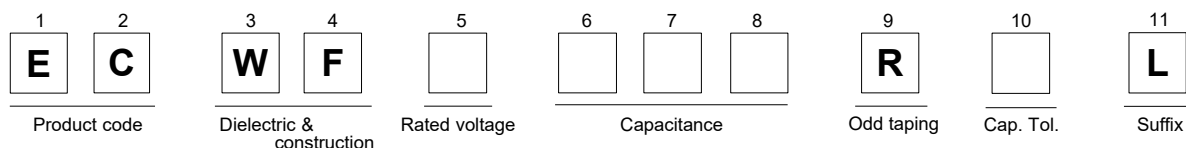

Specifications

Category temp. range (Including temperature-rise on unit surface)	-40 °C to +105 °C	
Rated voltage [DC]	400 V, 630 V	
Capacitance range	400 V	0.022 μF to 2.4 μF (E12)
	630 V	0.010 μF to 1.3 μF (E12)
Capacitance tolerance	±3 % (H), ±5 % (J)	
Dissipation factor (tan δ)	tan δ ≤ 0.05 % (20 °C, 1 kHz)	
	tan δ ≤ 0.20 % (20 °C, 10 kHz)	
Withstand voltage	Between terminals : R.voltage (V) × 150 % 60 s	
Insulation resistance (IR)	400 V	C ≤ 0.33 μF : IR ≥ 9000 MΩ (20 °C, 100 V, 60 s)
	630 V	C > 0.33 μF : IR ≥ 3000 MΩ · μF (20 °C, 500 V, 60 s)

* In case of applying voltage in alternating current (50 Hz or 60 Hz sine wave) to a capacitor with DC rated voltage, please refer to the page of "Permissible voltage (R.M.S) in alternating current corresponding to DC rated voltage".

Dimensions

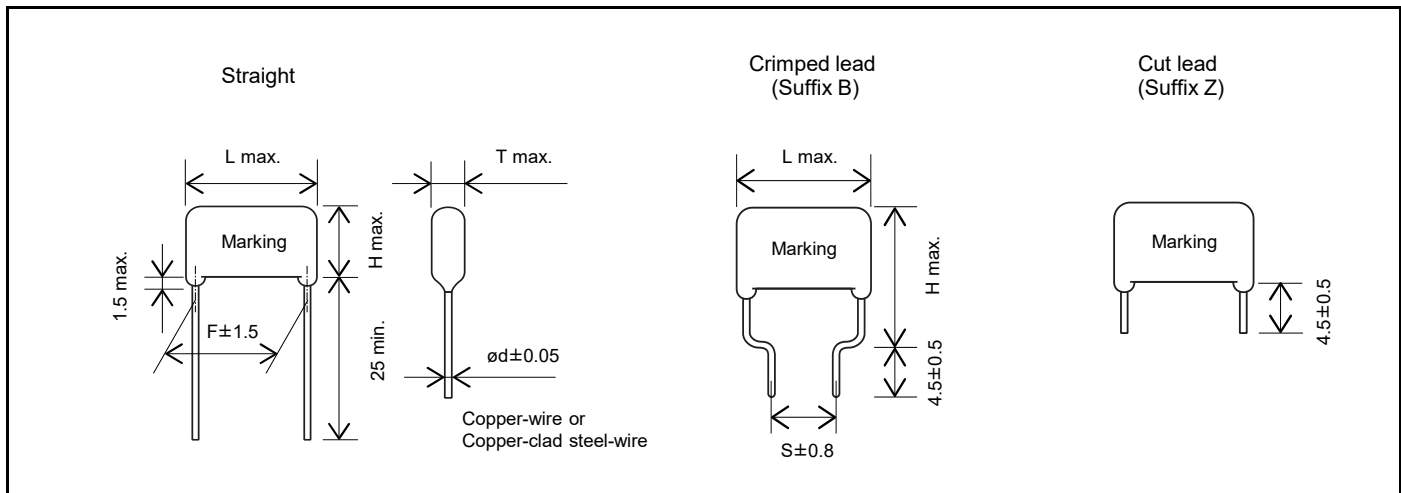

Packaging specifications for bulk package

- Packing quantity : 100 pcs./bag

Rating · Dimensions · Quantity

- Taping style

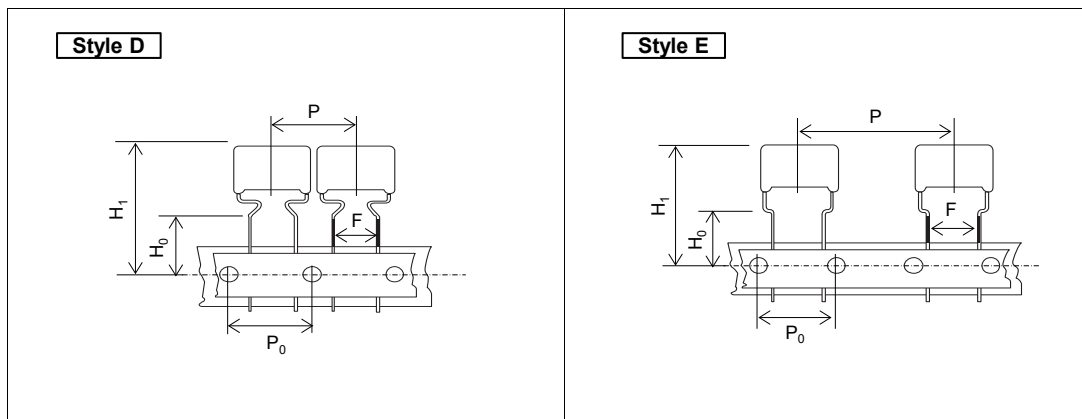

Size	Unit : mm	
	Style	
	D	E
P	15.0	30.0
P ₀	15.0	15.0
F	7.5	7.5
H ₀	16.0	16.0
H ₁ *	44.0	44.0

*:max.

* Please check the product drawing for the shape of the lead wire forming.
 The above diagram shows the taping dimensions, and the lead wire forming shape is an example.
 * H₁ dimension is based on insertion machine "Panaset RH series" made by Panasonic. Consult with Panasonic technical staff when using other insertion machines.

- Packaging specifications

Series	R.voltage (V) [DC]	Capacitance range (μF)	Taping style		Packing	Suffix
			D	E		
ECWF(L)	400	0.022 to 0.091	○		Ammo	R() L
		0.10 to 1.0		○	Ammo	R() L
	630	0.010 to 0.043	○		Ammo	R() L
		0.047 to 0.43		○	Ammo	R() L

- Lead spacing

Style	Lead spacing
D	7.5
E	7.5

See the column "Rating · Dimensions · Quantity" for packing quantity.

Rating · Dimensions · Quantity

■ Rated voltage [DC] : 400 V, Capacitance tolerance : ±3 %(H), ±5 %(J)

Part No.	Capacitance (μF)	Dimensions (mm)							Min. order Q'ty (PCS)			
		L max.	T max.	H max.		F	S		ød	Taping	Bulk	
				Straight	Crimped lead		Straight	Crimped lead		7.5 mm	Straight	Crimped lead
ECWF4223□L()	0.022	12.5	5.8	8.6	13.6	10.0	7.5	0.6	1100			
ECWF4243□L()	0.024	12.5	6.0	8.8	13.8	10.0	7.5	0.6				
ECWF4273□L()	0.027	12.5	6.2	9.0	14.0	10.0	7.5	0.6				
ECWF4303□L()	0.030	12.5	6.4	9.3	14.3	10.0	7.5	0.6	1000			
ECWF4333□L()	0.033	12.5	6.7	9.5	14.5	10.0	7.5	0.6				
ECWF4363□L()	0.036	12.5	5.7	8.4	13.4	10.0	7.5	0.6				
ECWF4393□L()	0.039	12.5	5.8	8.6	13.6	10.0	7.5	0.6	1100			
ECWF4433□L()	0.043	12.5	6.0	8.8	13.8	10.0	7.5	0.6				
ECWF4473□L()	0.047	12.5	6.2	9.0	14.0	10.0	7.5	0.6				
ECWF4513□L()	0.051	12.5	6.4	9.2	14.2	10.0	7.5	0.6	1000			
ECWF4563□L()	0.056	12.5	6.6	9.4	14.4	10.0	7.5	0.6				
ECWF4623□L()	0.062	13.0	6.8	9.6	14.6	10.0	7.5	0.8				
ECWF4683□L()	0.068	13.0	7.0	9.9	14.9	10.0	7.5	0.8	900			
ECWF4753□L()	0.075	13.0	7.3	10.1	15.1	10.0	7.5	0.8				
ECWF4823□L()	0.082	13.0	7.5	10.4	15.4	10.0	7.5	0.8				
ECWF4913□L()	0.091	13.0	7.8	10.7	15.7	10.0	7.5	0.8	800			
ECWF4104□L()	0.10	15.5	6.5	11.0	16.0	12.5	7.5	0.8				
ECWF4114□L()	0.11	15.5	6.8	11.3	16.3	12.5	7.5	0.8				
ECWF4124□L()	0.12	15.5	7.0	11.5	16.5	12.5	7.5	0.8	500			
ECWF4134□L()	0.13	15.5	7.2	11.8	16.8	12.5	7.5	0.8				
ECWF4144□L()	0.14	15.5	7.4	12.0	17.0	12.5	7.5	0.8				
ECWF4154□L()	0.15	15.5	7.6	12.2	17.2	12.5	7.5	0.8	400			
ECWF4164□L()	0.16	15.5	7.8	12.4	17.4	12.5	7.5	0.8				
ECWF4184□L()	0.18	15.5	8.2	12.8	17.8	12.5	7.5	0.8				
ECWF4204□L()	0.20	15.5	8.6	13.3	18.3	12.5	7.5	0.8	500			
ECWF4224□L()	0.22	15.5	9.0	13.6	18.6	12.5	7.5	0.8				
ECWF4244□L()	0.24	18.0	8.3	13.0	18.0	15.0	10.0	0.8				
ECWF4274□L()	0.27	18.0	8.8	13.4	18.4	15.0	10.0	0.8	300			
ECWF4304□L()	0.30	18.0	9.2	13.9	18.9	15.0	10.0	0.8				
ECWF4334□L()	0.33	18.0	9.6	14.3	19.3	15.0	10.0	0.8				
ECWF4364□L()	0.36	18.0	9.9	14.7	19.7	15.0	10.0	0.8	300			
ECWF4394□L()	0.39	18.0	10.3	15.1	20.1	15.0	10.0	0.8				
ECWF4434□L()	0.43	18.0	10.7	15.6	20.6	15.0	10.0	0.8				
ECWF4474□L()	0.47	18.0	11.2	16.1	21.1	15.0	10.0	0.8	200			
ECWF4514□L()	0.51	20.5	10.3	16.8	21.8	17.5	12.5	0.8				
ECWF4564□L()	0.56	20.5	10.7	17.3	22.3	17.5	12.5	0.8				
ECWF4624□L()	0.62	20.5	11.3	17.9	22.9	17.5	12.5	0.8	200			
ECWF4684□L()	0.68	20.5	11.8	18.5	23.5	17.5	12.5	0.8				
ECWF4754□L()	0.75	20.5	12.3	19.1	24.1	17.5	12.5	0.8				
ECWF4824□L()	0.82	23.0	11.8	18.5	23.5	20.0	12.5	0.8	200			
ECWF4914□L()	0.91	23.0	12.4	19.2	24.2	20.0	12.5	0.8				
ECWF4105□L()	1.0	23.0	13.0	19.8	24.8	20.0	12.5	0.8				
ECWF4115□L()	1.1	23.0	13.6	20.5	25.5	20.0	12.5	0.8	-			
ECWF4125□L()	1.2	28.0	12.3	19.1	24.1	25.0	17.5	0.8				
ECWF4135□L()	1.3	28.0	12.8	19.6	24.6	25.0	17.5	0.8				
ECWF4155□L()	1.5	28.0	13.7	20.7	25.7	25.0	17.5	0.8	-			
ECWF4165□L()	1.6	28.0	14.2	21.2	26.2	25.0	17.5	0.8				
ECWF4185□L()	1.8	28.0	15.2	22.2	27.2	25.0	17.5	0.8				
ECWF4205□L()	2.0	28.0	16.0	23.1	28.1	25.0	17.5	0.8	400			
ECWF4225□L()	2.2	28.0	16.8	24.0	29.0	25.0	17.5	0.8				
ECWF4245□L()	2.4	28.0	17.5	24.8	29.8	25.0	17.5	0.8				

* □ : Capacitance tolerance code
 () : Suffix for lead crimped or taped type

Rating · Dimensions · Quantity

■ Rated voltage [DC] : 630 V, Capacitance tolerance : ±3 % (H), ±5 % (J)

Part No.	Capacitance (μF)	Dimensions (mm)							Min. order Q'ty (PCS)			
		L max.	T max.	H max.		F	S		ød	Taping	Bulk	
				Straight	Crimped lead		Straight	Crimped lead		7.5 mm	Straight	Crimped lead
ECWF6103□L ()	0.010	12.5	5.2	8.0	13.0	10.0	7.5	0.6	1200	500	500	
ECWF6113□L ()	0.011	12.5	5.4	8.2	13.2	10.0	7.5	0.6				
ECWF6123□L ()	0.012	12.5	5.5	8.3	13.3	10.0	7.5	0.6				
ECWF6133□L ()	0.013	12.5	5.6	8.5	13.5	10.0	7.5	0.6	1100			
ECWF6153□L ()	0.015	12.5	5.9	8.7	13.7	10.0	7.5	0.6				
ECWF6163□L ()	0.016	12.5	6.0	8.9	13.9	10.0	7.5	0.6				
ECWF6183□L ()	0.018	12.5	6.2	9.1	14.1	10.0	7.5	0.6	1000			
ECWF6203□L ()	0.020	12.5	6.5	9.3	14.3	10.0	7.5	0.6				
ECWF6223□L ()	0.022	12.5	6.2	9.0	14.0	10.0	7.5	0.6				
ECWF6243□L ()	0.024	12.5	6.4	9.2	14.2	10.0	7.5	0.6	900			
ECWF6273□L ()	0.027	13.0	6.6	9.5	14.5	10.0	7.5	0.8				
ECWF6303□L ()	0.030	13.0	6.9	9.7	14.7	10.0	7.5	0.8				
ECWF6333□L ()	0.033	13.0	7.1	10.0	15.0	10.0	7.5	0.8	800			
ECWF6363□L ()	0.036	13.0	7.3	10.2	15.2	10.0	7.5	0.8				
ECWF6393□L ()	0.039	13.0	7.6	10.4	15.4	10.0	7.5	0.8				
ECWF6433□L ()	0.043	13.0	7.9	10.7	15.7	10.0	7.5	0.8	500			
ECWF6473□L ()	0.047	15.5	6.4	10.8	15.8	12.5	7.5	0.8				
ECWF6513□L ()	0.051	15.5	6.6	11.0	16.0	12.5	7.5	0.8				
ECWF6563□L ()	0.056	15.5	6.8	11.2	16.2	12.5	7.5	0.8	400			
ECWF6623□L ()	0.062	15.5	7.1	11.5	16.5	12.5	7.5	0.8				
ECWF6683□L ()	0.068	15.5	7.4	11.8	16.8	12.5	7.5	0.8				
ECWF6753□L ()	0.075	15.5	7.7	12.1	17.1	12.5	7.5	0.8				
ECWF6823□L ()	0.082	15.5	8.0	12.4	17.4	12.5	7.5	0.8				
ECWF6913□L ()	0.091	15.5	8.3	12.7	17.7	12.5	7.5	0.8				
ECWF6104□L ()	0.10	18.0	7.7	12.1	17.1	15.0	10.0	0.8	300			
ECWF6114□L ()	0.11	18.0	8.0	12.4	17.4	15.0	10.0	0.8				
ECWF6124□L ()	0.12	18.0	8.3	12.7	17.7	15.0	10.0	0.8				
ECWF6134□L ()	0.13	18.0	8.5	13.0	18.0	15.0	10.0	0.8				
ECWF6154□L ()	0.15	18.0	9.1	13.5	18.5	15.0	10.0	0.8				
ECWF6164□L ()	0.16	18.0	9.3	13.8	18.8	15.0	10.0	0.8				
ECWF6184□L ()	0.18	18.0	9.8	14.2	19.1	15.0	10.0	0.8	200			
ECWF6204□L ()	0.20	18.0	10.3	14.7	19.7	15.0	10.0	0.8				
ECWF6224□L ()	0.22	18.0	10.8	15.5	20.5	15.0	10.0	0.8				
ECWF6244□L ()	0.24	18.0	11.2	15.9	20.9	15.0	10.0	0.8	300			
ECWF6274□L ()	0.27	20.5	10.4	16.7	21.7	17.5	12.5	0.8				
ECWF6304□L ()	0.30	20.5	10.9	17.2	22.2	17.5	12.5	0.8				
ECWF6334□L ()	0.33	20.5	11.4	17.7	22.7	17.5	12.5	0.8	200			
ECWF6364□L ()	0.36	20.5	11.9	18.5	23.5	17.5	12.5	0.8				
ECWF6394□L ()	0.39	20.5	12.4	19.0	24.0	17.5	12.5	0.8				
ECWF6434□L ()	0.43	20.5	13.0	19.5	24.5	17.5	12.5	0.8	-			
ECWF6474□L ()	0.47	20.5	13.5	20.1	25.1	17.5	12.5	0.8				
ECWF6514□L ()	0.51	28.0	11.1	17.3	22.3	25.0	17.5	0.8				
ECWF6564□L ()	0.56	28.0	11.6	17.8	22.8	25.0	17.5	0.8				
ECWF6624□L ()	0.62	28.0	12.1	18.7	23.7	25.0	17.5	0.8				
ECWF6684□L ()	0.68	28.0	12.7	19.3	24.3	25.0	17.5	0.8				
ECWF6754□L ()	0.75	28.0	13.3	19.9	24.9	25.0	17.5	0.8				
ECWF6824□L ()	0.82	28.0	13.9	20.5	25.5	25.0	17.5	0.8				
ECWF6914□L ()	0.91	28.0	14.6	21.2	26.2	25.0	17.5	0.8				
ECWF6105□L ()	1.0	28.0	15.5	22.3	27.3	25.0	17.5	0.8				
ECWF6115□L ()	1.1	28.0	16.3	23.0	28.0	25.0	17.5	0.8				
ECWF6125□L ()	1.2	28.0	17.0	23.7	28.7	25.0	17.5	0.8	400	400		
ECWF6135□L ()	1.3	28.0	17.6	24.4	29.4	25.0	17.5	0.8				

* □ : Capacitance tolerance code
 () : Suffix for lead crimped or taped type

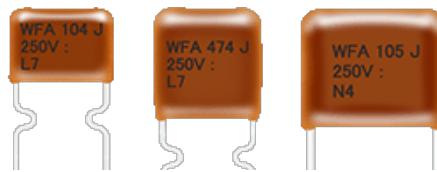

Plastic Film Capacitors

Metallized Polypropylene Film Capacitor

ECWF(A) series

Non-inductive construction using metallized polypropylene film with flame retardant epoxy resin coating

Features

- High safety (with safety function)
- Small size
- Excellent frequency characteristics
- Low loss
- Low hum sound noise
- Flame retardant epoxy resin coating
- 85 °C , 85 %RH , 500 V, 500 hours (630 V)
- RoHS compliant

Recommended applications

- 250 V, 630 V : High frequency and high current circuit
- 450 V: Active filter circuit

Explanation of part number

■ 250 V, 450 V (Bulk)

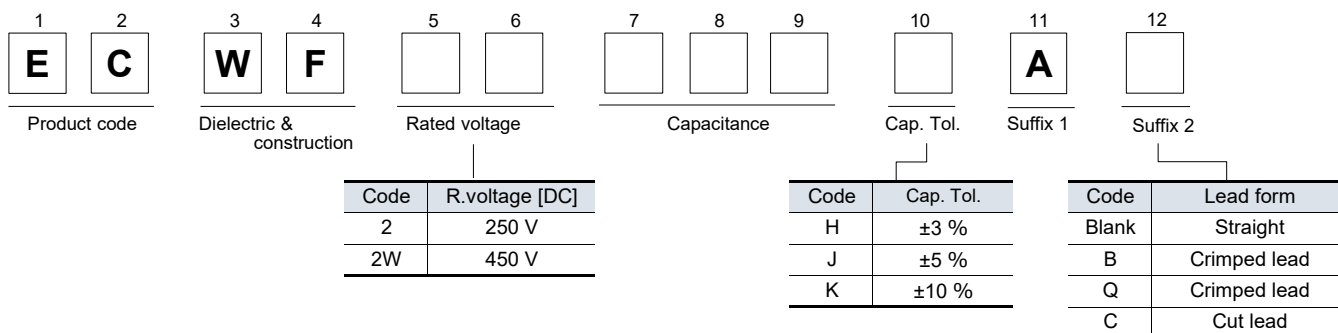

■ 250 V, 450 V (Odd size taping)

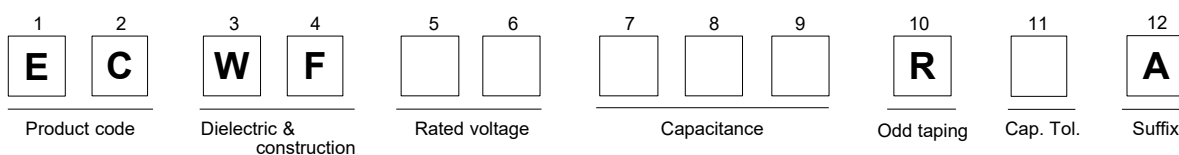

■ 630 V (Bulk, Odd size taping)

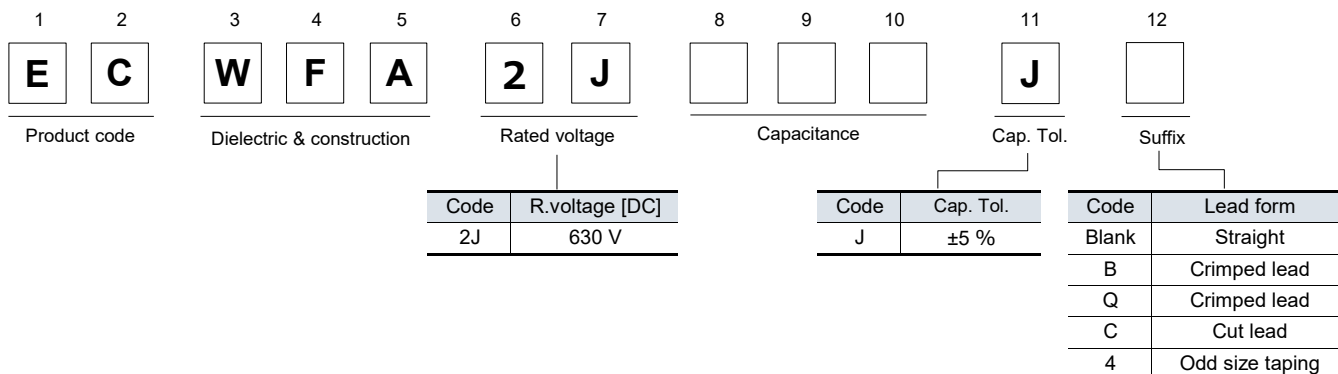

Specifications

Category temp. range (Including temperature-rise on unit surface)	-40 °C to +105 °C	
Rated voltage [DC]	250 V	
	450 V	(Derating of rated voltage by 1.25%/°C at more than 85 °C) Peak to peak voltage applied on the capacitor should be less than 240 Vp-p, and zero to peak voltage should be less than 450 Vo-p.
	630 V	(Derating of rated voltage by 1.0%/°C at more than 85 °C)
Capacitance range	250 V	0.1 µF to 6.8 µF
	450 V	0.1 µF to 4.7 µF
	630 V	0.1 µF to 2.2 µF
Capacitance tolerance	250 V	±3 % (H), ±5 % (J)
	450 V	±5 % (J), ±10 % (K)
	630 V	±5 % (J)
Dissipation factor (tan δ)	tan δ ≤ 0.1 % (20 °C, 1 kHz)	
Withstand voltage	Between terminals : Rated voltage (V) × 150 % 60 s	
Insulation resistance (IR)	250 V	C ≤ 0.33 µF : IR ≥ 9,000 MΩ C > 0.33 µF : IR ≥ 3,000 MΩ·µF (20 °C, 100 V, 60 s)
	450 V	C ≤ 0.33 µF : IR ≥ 30,000 MΩ C > 0.33 µF : IR ≥ 10,000 MΩ·µF (20 °C, 100 V, 60 s)
	630 V	C ≤ 0.33 µF : IR ≥ 9,000 MΩ C > 0.33 µF : IR ≥ 3,000 MΩ·µF (20 °C, 500 V, 60 s)

* In case of applying voltage in alternating current (50 Hz or 60 Hz sine wave) to a capacitor with DC rated voltage, please refer to the page of "Permissible voltage (R.M.S) in alternating current corresponding to DC rated voltage".

Dimensions

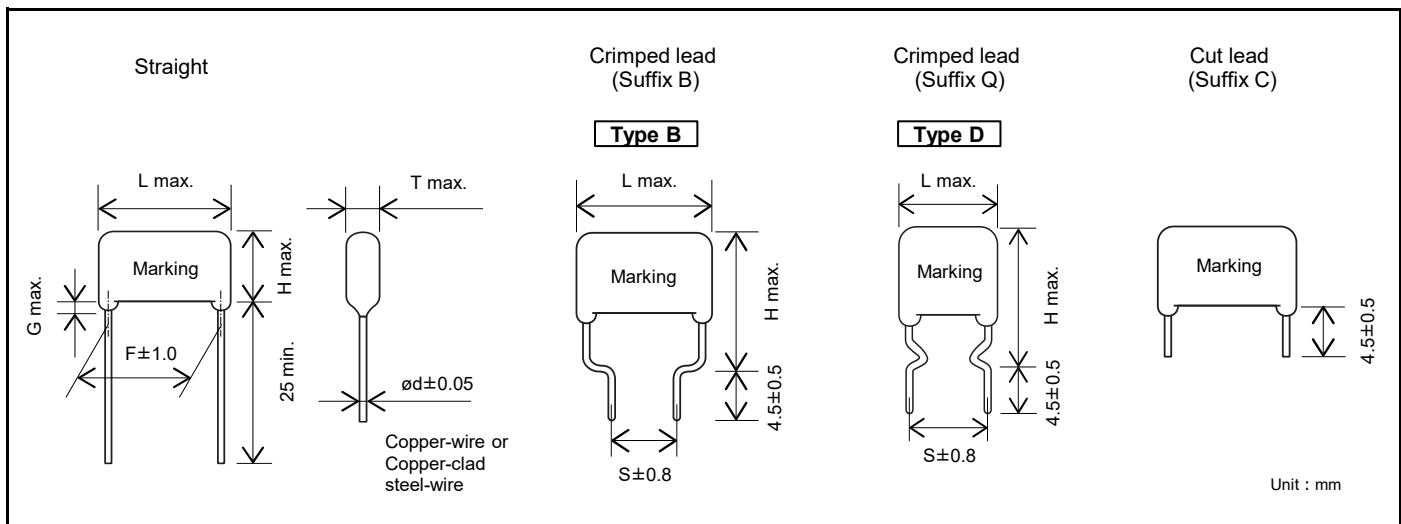

Packaging specifications for bulk package

- Packing quantity : 100 pcs./bag

Taping specifications for automatic insertion

■ Taping style

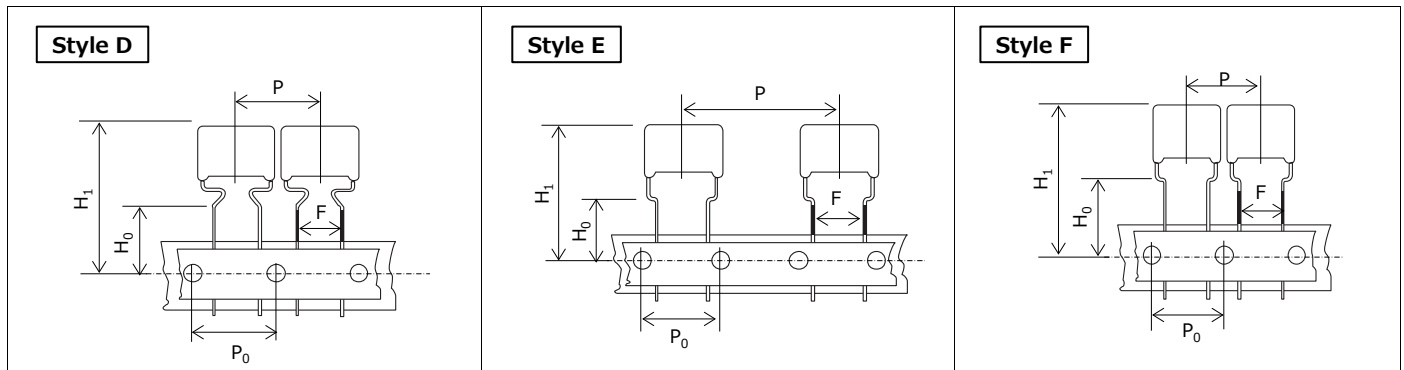

* Please check the product drawing for the shape of the lead wire forming.
 The above diagram shows the taping dimensions, and the lead wire forming shape is an example.
 * H₁ dimension is based on insertion machine "Panaset RH series" made by Panasonic.
 Consult with Panasonic technical staff when using other insertion machines.

Size	Style		
	D	E	F
P	15.0	30.0	15.0
P ₀	15.0	15.0	15.0
F	7.5	7.5	7.5
H ₀	16.0	16.0	16.0
H ₁ *	44.0	44.0	44.0

*:max.

■ Packaging specifications

Series	R. voltage (V) [DC]	Capacitance range (μF)	Taping style			Packing	Suffix
			D	E	F		
ECWF(A)	250	0.10 to 0.47	○			Ammo	R()A
		0.56 to 3.9		○		Ammo	R()A
	450	0.10 to 0.47			○	Ammo	R()A
		0.56 to 2.2		○		Ammo	R()A
630	0.10 to 0.68		○		Ammo	J4	

See the column "Rating · Dimensions · Quantity" for packing quantity.

● Lead spacing

Style	Lead spacing
D	7.5
E	7.5
F	7.5

Unit : mm

Rating · Dimensions · Quantity

■ Rated voltage [DC] : 250 V, Capacitance tolerance : ±3 % (H), ±5 % (J)

Part No.	Capacitance (μF)	Dimensions (mm)										Min. order Q'ty (PCS)			
		L max.	T max.	H max.			F	S			G max.	ød	Taping	Bulk	
				Straight	Crimped lead (Suffix B)	Crimped lead (Suffix Q)		Straight	Crimped lead (Suffix B)	Crimped lead (Suffix Q)			Straight	7.5 mm	Straight · Crimped lead
ECWF2104□A()	0.10	13.0	5.0			14.1	14.1			7.5	10.0		0.6	1300	500
ECWF2124□A()	0.12	13.0	5.3			14.4	14.4			7.5	10.0		0.6	1200	
ECWF2154□A()	0.15	13.0	5.6			14.7	14.7			7.5	10.0		0.6	1100	
ECWF2184□A()	0.18	13.0	5.9			15.1	15.1			7.5	10.0		0.6	1000	
ECWF2224□A()	0.22	13.0	6.3			15.4	15.4			7.5	10.0		0.6	1000	
ECWF2274□A()	0.27	13.0	6.8			15.9	15.9			7.5	10.0		0.6	900	
ECWF2334□A()	0.33	13.0	7.3			16.4	16.4			7.5	10.0		0.6	900	
ECWF2394□A()	0.39	13.0	7.8			16.9	16.9			7.5	10.0		0.6	800	
ECWF2474□A()	0.47	13.0	8.4			17.6	17.6			7.5	10.0		0.6	700	
ECWF2564□A()	0.56	18.1	6.9			16.4	18.4			7.5	15.0		0.8	400	
ECWF2684□A()	0.68	18.1	7.4			17.0	19.0			7.5	15.0		0.8		
ECWF2824□A()	0.82	18.1	8.0			17.6	19.6			7.5	15.0		0.8		
ECWF2105□A()	1.0	18.1	8.5	13.3	18.3	20.3	15.0	7.5	15.0	1.5	0.8		0.8	300	
ECWF2125□A()	1.2	18.8	9.5	14.6	19.6	21.6	15.0	7.5	15.0	1.5	0.8		0.8		
ECWF2155□A()	1.5	18.8	10.5	15.6	20.6	22.6	15.0	7.5	15.0	1.5	0.8		0.8		
ECWF2185□A()	1.8	18.8	11.4	16.5	21.5	23.5	15.0	7.5	15.0	1.5	0.8		0.8		
ECWF2225□A()	2.2	18.8	12.6	17.6	22.6	24.6	15.0	7.5	15.0	1.5	0.8		0.8	200	
ECWF2275□A()	2.7	23.8	11.4	17.2	22.2	24.2	20.0	12.5	20.0	1.5	0.8		0.8	300	
ECWF2335□A()	3.3	23.8	12.5	18.3	23.3	25.3	20.0	12.5	20.0	1.5	0.8		0.8	200	
ECWF2395□A()	3.9	23.8	13.5	19.3	24.3	26.3	20.0	12.5	20.0	1.5	0.8		0.8		
ECWF2475□A()	4.7	23.8	14.8	20.6	25.6	27.6	20.0	12.5	20.0	1.5	0.8		0.8	-	
ECWF2565□A()	5.6	23.8	16.2	21.9	26.9	28.9	20.0	12.5	20.0	1.5	0.8		0.8		
ECWF2685□A()	6.8	23.8	17.8	23.5	28.5	30.5	20.0	12.5	20.0	1.5	0.8		0.8		

* □ : Capacitance tolerance code () : Suffix for lead crimped or taped type

Rating · Dimensions · Quantity

■ Rated voltage [DC] : 450 V, Capacitance tolerance : ± 5 %(J), ±10 %(K)

Part No.	Capacitance (μF)	Dimensions (mm)										Min. order Q'ty (PCS)	
		L max.	T max.	H max.			F	S		G max.	ød	Taping	Bulk
				Straight	Crimped lead (Suffix B)	Crimped lead (Suffix Q)		Crimped lead (Suffix B)	Crimped lead (Suffix Q)			7.5 mm	Straight-Crimped lead
ECWF2W104□A()	0.10	13.0	5.1		14.3	14.3		7.5	10.0	1.5	0.6	1200	500
ECWF2W124□A()	0.12	13.0	5.4		14.5	14.5		7.5	10.0	1.5	0.6		
ECWF2W154□A()	0.15	13.0	5.7		14.9	14.9		7.5	10.0	1.5	0.6		
ECWF2W184□A()	0.18	13.0	6.1		15.2	15.2		7.5	10.0	1.5	0.6	1000	
ECWF2W224□A()	0.22	13.0	6.5	-	15.6	15.6	-	7.5	10.0	1.5	0.6		
ECWF2W274□A()	0.27	13.0	7.0		16.1	16.1		7.5	10.0	1.5	0.6		
ECWF2W334□A()	0.33	13.0	7.6		16.7	16.7		7.5	10.0	1.5	0.6	800	
ECWF2W394□A()	0.39	13.0	8.1		17.2	17.2		7.5	10.0	1.5	0.6		
ECWF2W474□A()	0.47	13.0	8.7		17.9	17.9		7.5	10.0	1.5	0.6		
ECWF2W564□A()	0.56	18.1	7.0	11.5	16.5	18.5	15.0	7.5	15.0	1.5	0.8	400	
ECWF2W684□A()	0.68	18.1	7.5	12.1	17.1	19.1	15.0	7.5	15.0	1.5	0.8		
ECWF2W824□A()	0.82	18.1	8.2	12.7	17.7	19.7	15.0	7.5	15.0	1.5	0.8		
ECWF2W105□A()	1.0	18.1	9.3	12.6	17.6	19.6	15.0	7.5	15.0	1.5	0.8	300	
ECWF2W125□A()	1.2	18.8	9.7	14.7	19.7	21.7	15.0	7.5	15.0	1.5	0.8		
ECWF2W155□A()	1.5	18.8	10.7	15.8	20.8	22.8	15.0	7.5	15.0	1.5	0.8		
ECWF2W185□A()	1.8	18.8	11.6	16.7	21.7	23.7	15.0	7.5	15.0	1.5	0.8	200	
ECWF2W225□A()	2.2	18.8	12.8	17.9	22.9	24.9	15.0	7.5	15.0	1.5	0.8		
ECWF2W275□A()	2.7	26.3	10.6	16.5	21.5	23.5	22.5	15.0	22.5	1.5	0.8		
ECWF2W335□A()	3.3	26.3	11.7	17.5	22.5	24.5	22.5	15.0	22.5	1.5	0.8	-	
ECWF2W395□A()	3.9	26.3	12.6	18.4	23.4	25.4	22.5	15.0	22.5	1.5	0.8		
ECWF2W475□A()	4.7	26.3	13.8	19.6	24.6	26.6	22.5	15.0	22.5	1.5	0.8		

* □ : Capacitance tolerance code
 () : Suffix for lead crimped or taped type

■ Rated voltage [DC] : 630 V, Capacitance tolerance : ±5 %(J)

Part No.	Capacitance (μF)	Dimensions (mm)										Min. order Q'ty (PCS)		
		L max.	T max.	H max.			F	S		G max.	ød	Taping	Bulk	
				Straight	Crimped lead (Suffix B)	Crimped lead (Suffix Q)		Crimped lead (Suffix B)	Crimped lead (Suffix Q)			7.5 mm	Straight	Crimped lead
ECWFA2J104J()	0.10	18.2	5.2	10.4	15.4	15.4	15.0	7.5	15.0	1.5	0.6	600	1000	
ECWFA2J124J()	0.12	18.2	5.5	10.8	15.8	15.8	15.0	7.5	15.0	1.5	0.6			
ECWFA2J154J()	0.15	18.2	6.0	11.2	16.2	16.2	15.0	7.5	15.0	1.5	0.6			
ECWFA2J184J()	0.18	18.2	6.5	11.7	16.7	16.7	15.0	7.5	15.0	1.5	0.6	500		
ECWFA2J224J()	0.22	18.2	7.1	12.3	17.3	17.3	15.0	7.5	15.0	1.5	0.6			
ECWFA2J274J()	0.27	18.2	7.8	12.9	17.9	17.9	15.0	7.5	15.0	1.5	0.6			
ECWFA2J334J()	0.33	18.2	8.5	13.6	18.6	18.6	15.0	7.5	15.0	1.5	0.6	400		
ECWFA2J394J()	0.39	18.2	9.2	14.3	19.3	19.3	15.0	7.5	15.0	1.5	0.6			
ECWFA2J474J()	0.47	18.2	10.0	15.1	20.1	20.1	15.0	7.5	15.0	1.5	0.6			
ECWFA2J564J()	0.56	18.2	10.9	16.0	21.0	21.0	15.0	7.5	15.0	1.5	0.6	300		
ECWFA2J684J()	0.68	18.2	12.0	17.1	22.1	22.1	15.0	7.5	15.0	1.5	0.6			
ECWFA2J824J()	0.82	26.0	10.1	15.3	20.3	22.3	22.5	15.0	22.5	1.5	0.8			
ECWFA2J105J()	1.0	26.0	11.1	16.2	21.2	23.2	22.5	15.0	22.5	1.5	0.8	200		
ECWFA2J125J()	1.2	26.0	12.1	17.2	22.2	24.2	22.5	15.0	22.5	1.5	0.8			
ECWFA2J155J()	1.5	26.0	13.5	18.6	23.6	25.6	22.5	15.0	22.5	1.5	0.8			
ECWFA2J185J()	1.8	26.0	14.8	19.8	24.8	26.8	22.5	15.0	22.5	1.5	0.8	-		
ECWFA2J225J()	2.2	26.0	16.3	21.4	26.4	28.4	22.5	15.0	22.5	1.5	0.8			

() : Suffix for lead crimped or taped type

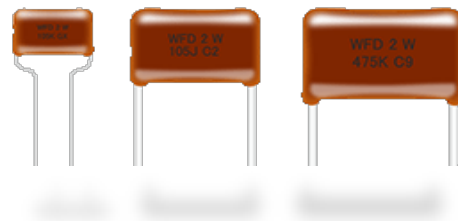

Plastic Film Capacitors

Metallized Polypropylene Film Capacitor

ECWFD series

Non-inductive construction using metallized polypropylene film with flame retardant epoxy resin coating

Features

- High safety (with safety function)
- Small size
- Excellent frequency characteristics
- Low loss
- Flame-retardant epoxy resin coating
- Low hum sound noise
- RoHS compliant

Recommended applications

- Active filter circuit
- High frequency circuit

Explanation of part number

■ Standard product

1	2	3	4	5	6	7	8	9	10	11	12																										
E	C	W	F	D																																	
Product code		Dielectric & construction			Rated voltage		Capacitance			Cap. Tol.	Suffix																										
					<table border="1"> <thead> <tr> <th>Code</th><th>R.voltage [DC]</th></tr> </thead> <tbody> <tr> <td>2W</td><td>450 V</td></tr> <tr> <td>2J</td><td>630 V</td></tr> </tbody> </table>		Code	R.voltage [DC]	2W	450 V	2J	630 V				<table border="1"> <thead> <tr> <th>Code</th><th>Cap. Tol.</th></tr> </thead> <tbody> <tr> <td>J</td><td>±5 %</td></tr> <tr> <td>K</td><td>±10 %</td></tr> </tbody> </table>	Code	Cap. Tol.	J	±5 %	K	±10 %	<table border="1"> <thead> <tr> <th>Code</th><th>Lead form</th></tr> </thead> <tbody> <tr> <td>Blank</td><td>Straight</td></tr> <tr> <td>B</td><td>Crimped lead</td></tr> <tr> <td>Q</td><td>Crimped lead</td></tr> <tr> <td>C</td><td>Cut lead</td></tr> <tr> <td>3</td><td>Crimped taping (Ammo)</td></tr> <tr> <td>4</td><td>Odd size taping</td></tr> </tbody> </table>	Code	Lead form	Blank	Straight	B	Crimped lead	Q	Crimped lead	C	Cut lead	3	Crimped taping (Ammo)	4	Odd size taping
Code	R.voltage [DC]																																				
2W	450 V																																				
2J	630 V																																				
Code	Cap. Tol.																																				
J	±5 %																																				
K	±10 %																																				
Code	Lead form																																				
Blank	Straight																																				
B	Crimped lead																																				
Q	Crimped lead																																				
C	Cut lead																																				
3	Crimped taping (Ammo)																																				
4	Odd size taping																																				

■ Short lead space product 450 V (0.47 μF, 0.68 μF, 1.0 μF), 630 V (1.0 μF)

1	2	3	4	5	6	7	8	9	10	11	12																										
E	C	W	F	D																																	
Product code		Dielectric & construction			Rated voltage		Capacitance			Cap. Tol.	Suffix																										
					<table border="1"> <thead> <tr> <th>Code</th><th>R.voltage [DC]</th></tr> </thead> <tbody> <tr> <td>2W</td><td>450 V</td></tr> <tr> <td>2J</td><td>630 V</td></tr> </tbody> </table>		Code	R.voltage [DC]	2W	450 V	2J	630 V				<table border="1"> <thead> <tr> <th>Code</th><th>Cap. Tol.</th></tr> </thead> <tbody> <tr> <td>P</td><td>±5 % (J)</td></tr> <tr> <td>Q</td><td>±10 % (K)</td></tr> </tbody> </table>	Code	Cap. Tol.	P	±5 % (J)	Q	±10 % (K)	<table border="1"> <thead> <tr> <th>Code</th><th>Lead form</th></tr> </thead> <tbody> <tr> <td>1</td><td>Straight</td></tr> <tr> <td>B</td><td>Crimped lead</td></tr> <tr> <td>Q</td><td>Crimped lead</td></tr> <tr> <td>C</td><td>Cut lead</td></tr> <tr> <td>3</td><td>Crimped taping (Ammo)</td></tr> <tr> <td>4</td><td>Odd size taping</td></tr> </tbody> </table>	Code	Lead form	1	Straight	B	Crimped lead	Q	Crimped lead	C	Cut lead	3	Crimped taping (Ammo)	4	Odd size taping
Code	R.voltage [DC]																																				
2W	450 V																																				
2J	630 V																																				
Code	Cap. Tol.																																				
P	±5 % (J)																																				
Q	±10 % (K)																																				
Code	Lead form																																				
1	Straight																																				
B	Crimped lead																																				
Q	Crimped lead																																				
C	Cut lead																																				
3	Crimped taping (Ammo)																																				
4	Odd size taping																																				

Specifications		
Category temp. range (Including temperature-rise on unit surface)	450 V	-40 °C to +110 °C
	630 V	-40 °C to +105 °C
Rated voltage [DC]	450 V	Peak to peak voltage applied on the capacitor should be less than 240 Vp-p, and zero to peak voltage should be less than 450 Vo-p. (Derating of rated voltage by 0.62 %/°C at more than 85 °C)
	630 V	Peak to peak voltage applied on the capacitor should be less than 400 Vp-p, and zero to peak voltage should be less than 630 Vo-p. (Derating of rated voltage by 1.0%/°C at more than 85 °C)
Capacitance range	450 V	0.1 μF to 4.7 μF
	630 V	0.01 μF to 4.7 μF
Capacitance tolerance	±5% (J), ±10 % (K)	
Dissipation factor (tan δ)	tan δ ≤ 0.1 % (20 °C, 1 kHz)	
Withstand voltage	Between terminals : Rated voltage (V)×150 % 60 s	
Insulation resistance (IR)	450 V	C ≤ 0.33 μF : IR ≥ 30,000 MΩ (20 °C, 100 V, 60 s) C > 0.33 μF : IR ≥ 10,000 MΩ·μF
	630 V	C ≤ 0.33 μF : IR ≥ 9,000 MΩ C > 0.33 μF : IR ≥ 3,000 MΩ·μF (20 °C, 500 V , 60 s)

*: In case of applying voltage in alternating current (50 Hz or 60 Hz sine wave) to a capacitor with DC rated voltage, please refer to the page of "Permissible voltage (R.M.S) in alternating current corresponding to DC rated voltage".

Dimensions

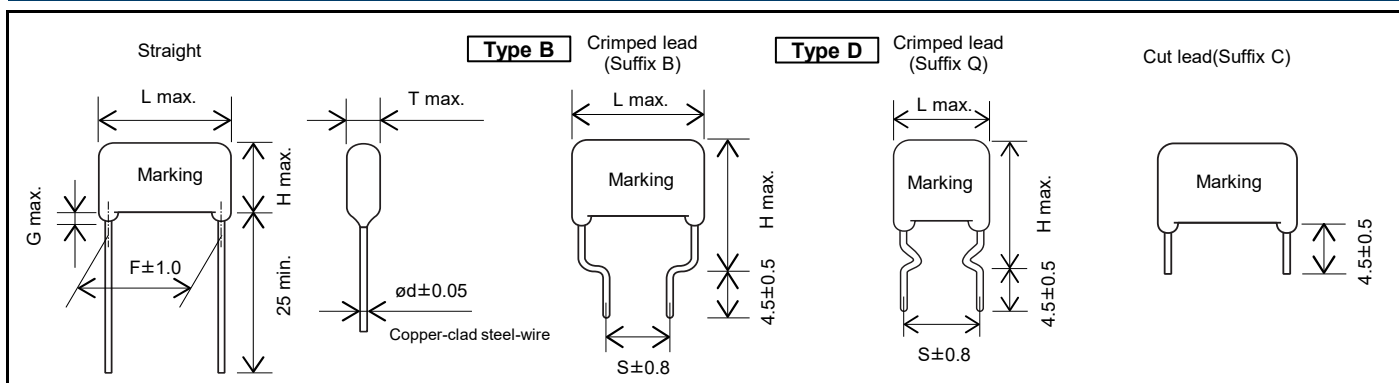

Packaging specifications for bulk package

■ Packing quantity : 100 pcs./bag

Taping specifications for automatic insertion

■ Taping style

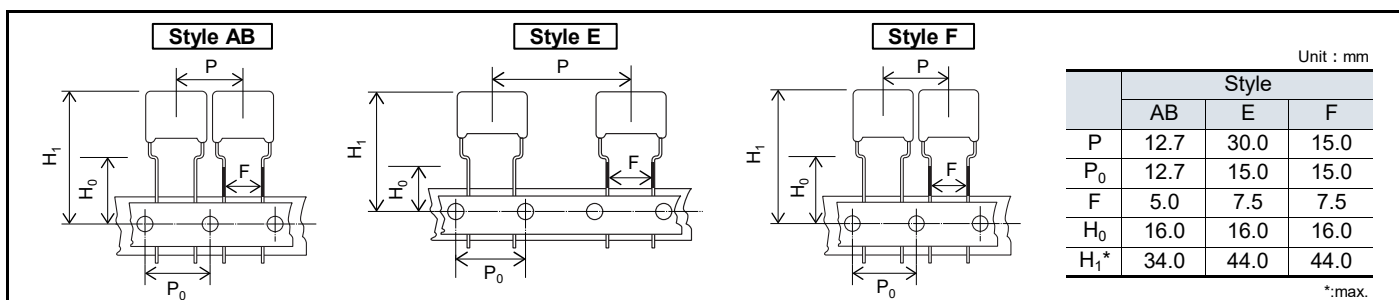

* Please check the product drawing for the shape of the lead wire forming.

The above diagram shows the taping dimensions, and the lead wire forming shape is an example.

* H₁ dimension is based on insertion machine "Panaset RH series" made by Panasonic. Consult with Panasonic technical staff when using other insertion machines.

■ Packaging specifications

Series	R. voltage (V) [DC]	Capacitance range (μF)	Taping style			Packing	suffix
			AB	E	F		
ECWFD	450	0.10 to 0.39	○			Crimped taping	3
		0.47, 0.68, 1.0	○				P3/Q3
		0.10 to 0.39			○	Odd size taping	4
		0.47, 0.68, 1.0			○		P4/Q4
	630	0.47 to 2.2		○		Odd size taping	4
		0.047 to 0.22		○			4
0.27 to 0.82			○		P4/Q4		

● Lead spacing

Style	Lead spacing
AB	5.0
E	7.5
F	7.5

Unit : mm

See the column "Rating · Dimensions · Quantity" for packaging quantity

Design and specifications are each subject to change without notice. Ask factory for the current technical specifications before purchase and/or use. Should a safety concern arise regarding this product, please be sure to contact us immediately.

Rating · Dimensions · Quantity

■ Rated voltage [DC] : 450 V, Capacitance tolerance : ±5 %(J), ± 10 %(K)

Part No.	Cap. (μF)	Dimensions (mm)										Min. order Q'ty (PCS)					
		L max.	T max.	H max.			F	S		G max.	ød	Taping		Bulk			
				Straight	Crimped lead (Suffix B)	Crimped lead (Suffix Q)		Crimped lead (Suffix B)	Crimped lead (Suffix Q)			Standard 5.0 mm	Odd size 7.5 mm	Straight	Crimped lead		
ECWFD2W104□()	0.10	12.6	4.5		13.9	13.9		7.5	10.0		0.6	1500	1400	-			
ECWFD2W124□()	0.12	12.6	4.6		14.0	14.0		7.5	10.0		0.6						
ECWFD2W154□()	0.15	12.6	4.6		14.1	14.1		7.5	10.0		0.6						
ECWFD2W184□()	0.18	12.6	4.8		14.3	14.3		7.5	10.0		0.6						
ECWFD2W224□()	0.22	12.6	5.0	-	14.6	14.6	-	7.5	10.0	-	0.6					1400	1300
ECWFD2W274□()	0.27	12.6	5.3		15.0	15.0		7.5	10.0		0.6					1300	1200
ECWFD2W334□()	0.33	12.6	5.6		15.4	15.4		7.5	10.0		0.6					1200	1100
ECWFD2W394□()	0.39	12.6	6.0		15.7	15.7		7.5	10.0		0.6					1100	1000
ECWFD2W474P()	0.47	12.6	6.5	11.2	16.2	16.2	10.0	7.5	10.0	1.5	0.6	1000	900				
ECWFD2W474Q()																	
ECWFD2W474□()	0.47	17.5	5.8	9.0	14.0	16.0	15.0	7.5	15.0	1.5	0.8	-	500				
ECWFD2W564□()	0.56	17.5	6.2	9.4	14.4	16.4	15.0	7.5	15.0	1.5	0.8						
ECWFD2W684P()	0.68	12.6	7.7	12.4	17.4	17.4	10.0	7.5	10.0	1.5	0.6	800	700				
ECWFD2W684Q()																	
ECWFD2W684□()	0.68	17.5	6.7	9.9	14.9	16.9	15.0	7.5	15.0	1.5	0.8	-	400				
ECWFD2W824□()	0.82	17.5	7.2	10.4	15.4	17.4	15.0	7.5	15.0	1.5	0.8						
ECWFD2W105P()	1.0	12.6	9.2	13.9	18.9	18.9	10.0	7.5	10.0	1.5	0.6	700	600				
ECWFD2W105Q()																	
ECWFD2W105□()	1.0	17.5	7.8	11.0	16.0	18.0	15.0	7.5	15.0	1.5	0.8		400				
ECWFD2W125□()	1.2	17.5	8.5	11.6	16.6	18.6	15.0	7.5	15.0	1.5	0.8						
ECWFD2W155□()	1.5	17.5	9.3	12.5	17.5	19.5	15.0	7.5	15.0	1.5	0.8		300				
ECWFD2W185□()	1.8	17.5	10.1	13.3	18.3	20.3	15.0	7.5	15.0	1.5	0.8						
ECWFD2W225□()	2.2	17.5	11.1	14.3	19.3	21.3	15.0	7.5	15.0	1.5	0.8	-	200				
ECWFD2W275□()	2.7	25.3	9.0	13.7	18.7	20.7	22.5	15.0	22.5	1.5	0.8						
ECWFD2W335□()	3.3	25.3	9.8	14.6	19.6	21.6	22.5	15.0	22.5	1.5	0.8						
ECWFD2W395□()	3.9	25.3	10.7	15.4	20.4	22.4	22.5	15.0	22.5	1.5	0.8			800			
ECWFD2W475□()	4.7	25.3	11.7	16.4	21.4	23.4	22.5	15.0	22.5	1.5	0.8			600	600		

* □ : Capacitance tolerance code
 * () : Suffix for lead crimped

Note) Part number marked with bold is short lead space product.

Rating · Dimensions · Quantity

■ Rated voltage [DC] : 630 V, Capacitance tolerance : ±5 % (J), ± 10 % (K)

Part No.	Cap. (μF)	Dimensions (mm)										Min. order Q'ty (PCS)		
		L max.	T max.	H max.			F	S		G max.	ød	Taping	Bulk	
				Straight	Crimped lead (Suffix B)	Crimped lead (Suffix Q)		Crimped lead (Suffix B)	Crimped lead (Suffix Q)			Odd size 7.5 mm	Straight	Crimped lead
ECWFD2J103□()	0.01	12.6	4.9	-	8.0	8.0	-	7.5	10.0	-	0.6	-	-	1000
ECWFD2J123□()	0.012	12.6	5.2	-	8.2	8.2	-	7.5	10.0	-	0.6	-	-	1000
ECWFD2J153□()	0.015	12.6	5.6	-	8.6	8.6	-	7.5	10.0	-	0.6	-	-	1000
ECWFD2J183□()	0.018	12.6	5.9	-	9.0	9.0	-	7.5	10.0	-	0.6	-	-	1000
ECWFD2J223□()	0.022	12.6	6.4	-	9.4	9.4	-	7.5	10.0	-	0.6	-	-	1000
ECWFD2J273□()	0.027	12.6	6.9	-	9.9	9.9	-	7.5	10.0	-	0.6	-	-	1000
ECWFD2J333□()	0.033	12.6	7.5	-	10.5	10.5	-	7.5	10.0	-	0.6	-	-	1000
ECWFD2J393□()	0.039	12.6	8.0	-	11.0	11.0	-	7.5	10.0	-	0.6	-	-	1000
ECWFD2J473□()	0.047	12.6	4.4	-	12.8	12.8	-	7.5	10.0	-	0.6	1300	-	1000
ECWFD2J563□()	0.056	12.6	4.7	-	13.1	13.1	-	7.5	10.0	-	0.6	1200	-	1000
ECWFD2J683□()	0.068	12.6	5.0	-	13.4	13.4	-	7.5	10.0	-	0.6	1000	-	1000
ECWFD2J823□()	0.082	12.6	5.4	-	13.7	13.7	-	7.5	10.0	-	0.6	900	-	1000
ECWFD2J104□()	0.10	12.6	5.8	-	14.2	14.2	-	7.5	10.0	-	0.6	700	-	1000
ECWFD2J124□()	0.12	12.6	6.2	-	14.6	14.6	-	7.5	10.0	-	0.6	500	-	1000
ECWFD2J154□()	0.15	12.6	6.8	-	15.2	15.2	-	7.5	10.0	-	0.6	400	-	1000
ECWFD2J184□()	0.18	12.6	7.4	-	15.7	15.7	-	7.5	10.0	-	0.6	300	-	1000
ECWFD2J224□()	0.22	12.6	8.1	-	16.4	16.4	-	7.5	10.0	-	0.6	200	-	1000
ECWFD2J274□()	0.27	17.8	6.0	11.0	16.0	18.0	15.0	7.5	15.0	1.5	0.8	500	-	1000
ECWFD2J334□()	0.33	17.8	6.6	11.5	16.5	18.5	15.0	7.5	15.0	1.5	0.8	400	-	1000
ECWFD2J394□()	0.39	17.8	7.1	12.0	17.0	19.0	15.0	7.5	15.0	1.5	0.8	300	-	1000
ECWFD2J474□()	0.47	17.8	7.8	12.7	17.7	19.7	15.0	7.5	15.0	1.5	0.8	200	-	1000
ECWFD2J564□()	0.56	17.8	8.4	13.3	18.3	20.3	15.0	7.5	15.0	1.5	0.8	100	-	1000
ECWFD2J684□()	0.68	17.8	9.3	14.2	19.2	21.2	15.0	7.5	15.0	1.5	0.8	800	-	1000
ECWFD2J824□()	0.82	17.8	10.2	15.1	20.1	22.1	15.0	7.5	15.0	1.5	0.8	600	-	1000
ECWFD2J105P()	1.0	17.8	11.2	16.1	21.1	23.1	15.0	7.5	15.0	1.5	0.8	500	600	800
ECWFD2J105Q()														
ECWFD2J105□()	1.0	25.3	8.4	13.5	18.5	20.5	22.5	15.0	22.5	1.5	0.8	400	-	1000
ECWFD2J125□()	1.2	25.3	9.2	14.3	19.3	21.3	22.5	15.0	22.5	1.5	0.8	300	-	1000
ECWFD2J155□()	1.5	25.3	10.3	15.5	20.5	22.5	22.5	15.0	22.5	1.5	0.8	200	-	1000
ECWFD2J185□()	1.8	25.3	11.2	16.5	21.5	23.5	22.5	15.0	22.5	1.5	0.8	100	-	1000
ECWFD2J225□()	2.2	25.3	12.4	17.7	22.7	24.7	22.5	15.0	22.5	1.5	0.8	800	-	1000
ECWFD2J275□()	2.7	25.3	13.8	19.2	24.2	26.2	22.5	15.0	22.5	1.5	0.8	600	-	1000
ECWFD2J335□()	3.3	25.3	15.3	20.7	25.7	27.7	22.5	15.0	22.5	1.5	0.8	400	-	1000
ECWFD2J395□()	3.9	25.3	16.6	22.1	27.1	29.1	22.5	15.0	22.5	1.5	0.8	300	-	1000
ECWFD2J475□()	4.7	25.3	18.3	23.9	28.9	30.9	22.5	15.0	22.5	1.5	0.8	200	-	1000

* □ : Capacitance tolerance code
 * () : Suffix for lead crimped

Note) Part number marked with bold is short lead space product.

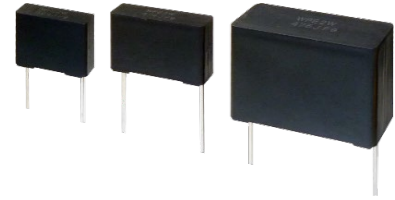

Plastic Film Capacitors

Metallized Polypropylene Film Capacitor

ECWFE series

Non-inductive construction using metallized polypropylene film with flame retardant plastic case.

Features

- High safety (with safety function)
- Small size
- Excellent frequency characteristics
- Low loss
- Flame retardant plastic case and non-combustible resin
- Low hum sound noise
- RoHS compliant

Recommended applications

- Active filter circuit
- High frequency circuit

Explanation of part number

■ Standard

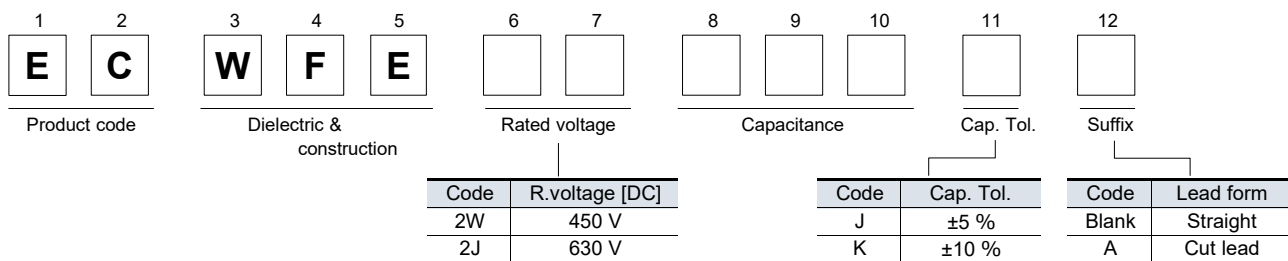

■ Special lead space product

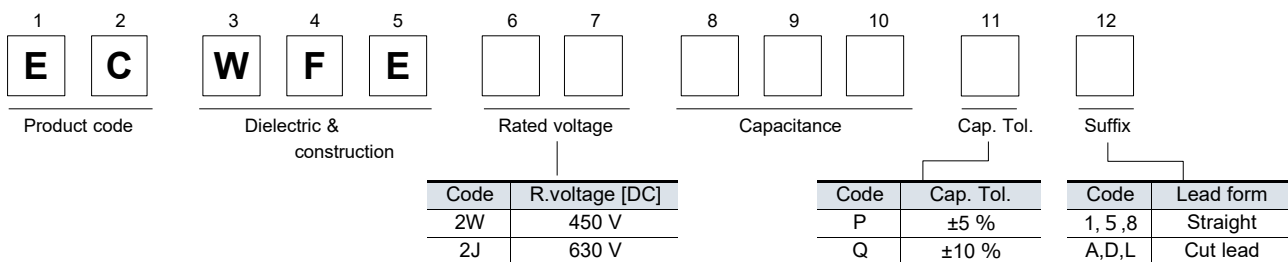

Specifications

Category temp. range (Including temperature-rise on unit surface)	-40 °C to +105 °C	
Rated voltage [DC]	450 V	Peak to peak voltage applied on the capacitor should be less than 240 Vp-p, and zero to peak voltage should be less than 450 Vo-p. (Derating of rated voltage by 1.25 %/°C at more than 85 °C)
	630 V	Peak to peak voltage applied on the capacitor should be less than 400 Vp-p, and zero to peak voltage should be less than 630 Vo-p. (Derating of rated voltage by 1.0%/°C at more than 85 °C)
Capacitance range	450 V	0.1 μF to 4.7 μF
	630 V	0.1 μF to 2.2 μF
Capacitance tolerance	±5% (J), ±10 % (K)	
Dissipation factor (tan δ)	tan δ ≤ 0.1 % (20 °C, 1 kHz)	
Withstand voltage	Between terminals : Rated voltage (V)×150 % 60 s	
Insulation resistance (IR)	450 V	C ≤ 0.33 μF : IR ≥ 30,000 MΩ C > 0.33 μF : IR ≥ 10,000 MΩ·μF (20 °C, 100 V, 60 s)
	630 V	C ≤ 0.33 μF : IR ≥ 9,000 MΩ C > 0.33 μF : IR ≥ 3,000 MΩ·μF (20 °C, 500 V, 60 s)

* In case of applying voltage in alternating current (50 Hz or 60 Hz sine wave) to a capacitor with DC rated voltage, please refer to the page of "Permissible voltage (R.M.S) in alternating current corresponding to DC rated voltage".

Dimensions

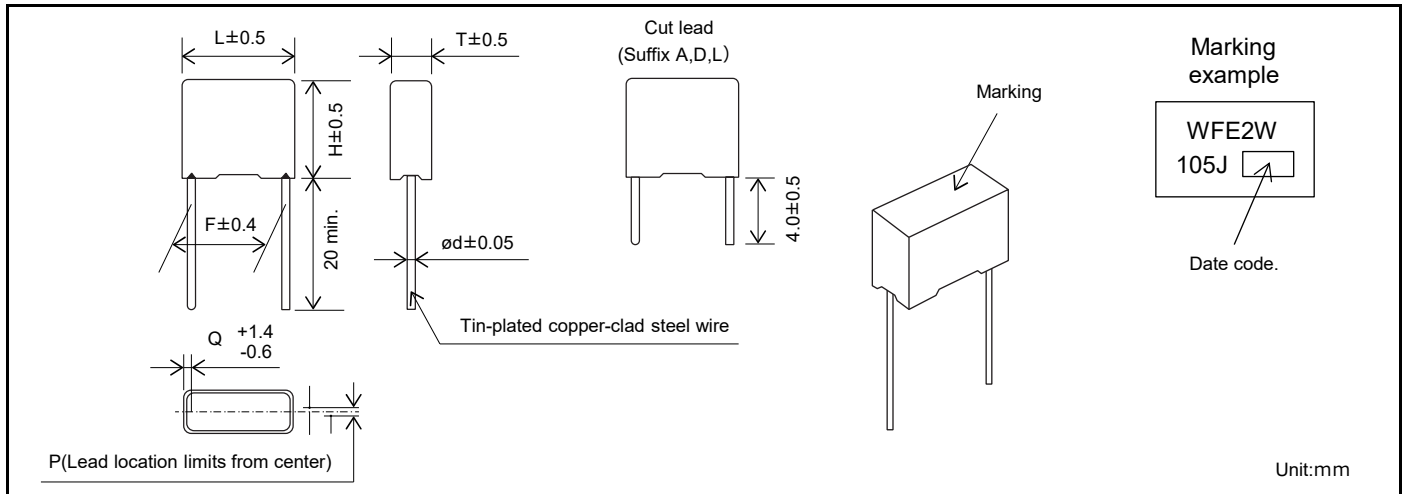

Rating · Dimensions · Quantity

■ Rated voltage [DC] : 450 V, Capacitance tolerance : $\pm 5\%$ (J), $\pm 10\%$ (K)

Part No.	Cap. (µF)	Dimensions (mm)							Min. order Q'ty (PCS)	
		L	T	H	F	ød	P	Q	Straight	Cut lead
ECWFE2W104□()	0.10	13.0	5.0	10.5	10.0	0.6	0±0.8	1.5	1000	1000
ECWFE2W104P()	0.10	17.5	5.0	10.5	15.0	0.6	0±0.8	1.25		
ECWFE2W104Q()										
ECWFE2W154□()	0.15	13.0	5.0	10.5	10.0	0.6	0±0.8	1.5		
ECWFE2W154P()	0.15	17.5	5.0	10.5	15.0	0.6	0±0.8	1.25		
ECWFE2W154Q()										
ECWFE2W224□()	0.22	13.0	6.0	12.0	10.0	0.6	0±0.8	1.5		
ECWFE2W224P()	0.22	17.5	5.0	10.5	15.0	0.6	0±0.8	1.25		
ECWFE2W224Q()										
ECWFE2W334□()	0.33	13.0	6.0	12.0	10.0	0.6	0±0.8	1.5		
ECWFE2W334P()	0.33	17.5	5.0	10.5	15.0	0.6	0±0.8	1.25		
ECWFE2W334Q()										
ECWFE2W474P()	0.47	13.0	7.0	12.5	10.0	0.6	0±0.8	1.5		
ECWFE2W474Q()										
ECWFE2W474□()	0.47	17.5	6.0	11.5	15.0	0.8	0±0.8	1.3		
ECWFE2W684□()	0.68	17.5	7.0	12.5	15.0	0.8	0±0.8	1.3		
ECWFE2W105□()	1.0	17.5	7.0	12.5	15.0	0.8	0±0.8	1.3		
ECWFE2W155□()	1.5	17.5	10.0	15.5	15.0	0.8	0±0.8	1.3	600	
ECWFE2W155P()	1.5	31.0	9.0	19.0	27.5	0.8	0±0.8	1.75	400	300
ECWFE2W155Q()										
ECWFE2W225□()	2.2	17.5	10.0	15.5	15.0	0.8	0±0.8	1.3	1000	600
ECWFE2W225P()	2.2	31.0	11.0	21.0	27.5	0.8	0±0.8	1.75	200	200
ECWFE2W225Q()										
ECWFE2W335□()	3.3	26.0	10.0	17.0	22.5	0.8	0±0.8	1.8	500	300
ECWFE2W335P()	3.3	31.0	13.0	23.0	27.5	0.8	0±0.8	1.75	200	200
ECWFE2W335Q()										
ECWFE2W475□()	4.7	26.0	12.0	19.0	22.5	0.8	0±0.8	1.8	300	200
ECWFE2W475P()	4.7	31.0	15.5	25.5	27.5	0.8	0±0.8	1.75	150	100
ECWFE2W475Q()										

* □ : Capacitance tolerance code
 * () : Suffix for lead crimped

Note) Part number marked with bold is special lead space product.
 The capacitance of 0.10 µF, 0.15 µF, 0.22 µF, 0.33 µF, 3.3 µF, 4.7 µF are "5" or "D"
 The capacitance of 0.47 µF is "1" or "A"
 The capacitance of 1.5 µF, 2.2 µF are "8" or "L"

Rating · Dimensions · Quantity

■ Rated voltage [DC] : 630 V [DC], Capacitance tolerance : $\pm 5\%$ (J), $\pm 10\%$ (K)

Part No.	Cap. (μ F)	Dimensions (mm)							Min. order Q'ty (PCS)	
		L	T	H	F	ϕ d	P	Q	Straight	Cut lead
ECWFE2J104□()	0.10	17.5	5.0	10.5	15.0	0.6	0 \pm 0.8	1.3	1000	1000
ECWFE2J104P()	0.10	26.0	6.0	13.0	22.5	0.8	0 \pm 0.8	1.75	900	700
ECWFE2J104Q()										
ECWFE2J154□()	0.15	17.5	6.0	11.5	15.0	0.6	0 \pm 0.8	1.3	1000	1000
ECWFE2J154P()	0.15	26.0	6.0	13.0	22.5	0.8	0 \pm 0.8	1.75	900	700
ECWFE2J154Q()										
ECWFE2J224□()	0.22	17.5	7.0	12.5	15.0	0.6	0 \pm 0.8	1.3	1000	1000
ECWFE2J224P()	0.22	26.0	6.0	13.0	22.5	0.8	0 \pm 0.8	1.75	900	700
ECWFE2J224Q()										
ECWFE2J334□()	0.33	17.5	8.5	14.5	15.0	0.6	0 \pm 0.8	1.3	1000	800
ECWFE2J334P()	0.33	26.0	7.0	14.0	22.5	0.8	0 \pm 0.8	1.75	700	500
ECWFE2J334Q()										
ECWFE2J474□()	0.47	17.5	10.0	15.5	15.0	0.6	0 \pm 0.8	1.3	1000	600
ECWFE2J474P()	0.47	26.0	8.0	15.0	22.5	0.8	0 \pm 0.8	1.75	600	400
ECWFE2J474Q()										
ECWFE2J684□()	0.68	17.5	11.0	17.5	15.0	0.6	0 \pm 0.8	1.3	600	600
ECWFE2J105□()	1.0	26.0	10.0	17.0	22.5	0.8	0 \pm 0.8	1.8	500	300
ECWFE2J105P()	1.0	31.0	9.0	19.0	27.5	0.8	0 \pm 0.8	1.75	400	
ECWFE2J105Q()										
ECWFE2J155□()	1.5	26.0	12.0	19.0	22.5	0.8	0 \pm 0.8	1.8	300	200
ECWFE2J155P()	1.5	31.0	11.0	21.0	27.5	0.8	0 \pm 0.8	1.75	200	
ECWFE2J155Q()										
ECWFE2J225□()	2.2	26.0	16.0	23.0	22.5	0.8	0 \pm 0.8	1.8	200	
ECWFE2J225P()	2.2	31.0	13.0	23.0	27.5	0.8	0 \pm 0.8	1.75		
ECWFE2J225Q()										

* □ : Capacitance tolerance code

* () : Suffix for lead crimped

Note) Part Number marked with bold is Special Lead space product.

The capacitance of 0.10 μ F, 0.15 μ F, 0.22 μ F, 0.33 μ F, 0.47 μ F, 1.0 μ F, 1.5 μ F, 2.2 μ F are "5" or "D"

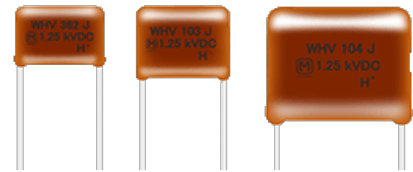

Plastic Film Capacitors

Metallized Polypropylene Film Capacitor

ECWH(V) series

Non-inductive construction using metallized polypropylene film with flame retardant epoxy resin coating

Features

- Low-loss
- Excellent electrical characteristics
- Flame retardant epoxy resin coating
- RoHS compliant

Recommended applications

- High frequency high voltage circuit (General resonance, inverter circuit)

Explanation of part number

1	2	3	4	5	6	7	8	9	10	11	12
E	C	W	H							V	
Product code	Dielectric & construction		Rated voltage		Capacitance			Cap. Tol.	Suffix 1	Suffix 2	

Code	R.voltage [DC]
10	1000 V
12	1250 V
16	1600 V
20	2000 V

Code	Cap. Tol.
H	±3 %
J	±5 %

Code	Lead form
Blank	Straight
B	Crimped lead
C	Cut lead

■ Odd size taping

1	2	3	4	5	6	7	8	9	10	11	12
E	C	W	H						R		V
Product code	Dielectric & construction		Rated voltage		Capacitance			Odd taping	Cap. Tol.	Suffix	

Specifications

Category temp. range (Including temperature-rise on unit surface)	-40 °C to +105 °C		
Rated voltage [DC]	1000 V	—	(Derating of rated voltage by 1.25 %/°C at more than 85 °C)
	1250 V	1000 Vp-p	
	1600 V	1200 Vp-p	
	2000 V	1500 Vp-p	
Capacitance range	1000 V	0.0075 μF to 0.10 μF	
	1250 V	0.0036 μF to 0.10 μF	
	1600 V	0.0013 μF to 0.056 μF	
	2000 V	0.001 μF to 0.015 μF	
Capacitance tolerance	±3% (H), ±5 % (J)		
Dissipation factor (tan δ)	tan δ ≤ 0.1 % (20 °C, 1 kHz)		
	tan δ ≤ 0.2 % (20 °C, 10 kHz)		
Withstand voltage	Between terminals : Rated voltage (V) × 150 % 60 s		
	Between terminals to enclosure : 1500 V [AC] 60 s		
Insulation resistance (IR)	IR ≥ 30,000 MΩ (20 °C, 500 V, 60 s)		

* In case of applying voltage in alternating current (50 Hz or 60 Hz sine wave) to a capacitor with DC rated voltage, please refer to the page of "Permissible voltage (R.M.S) in alternating current corresponding to DC rated voltage".

Dimensions

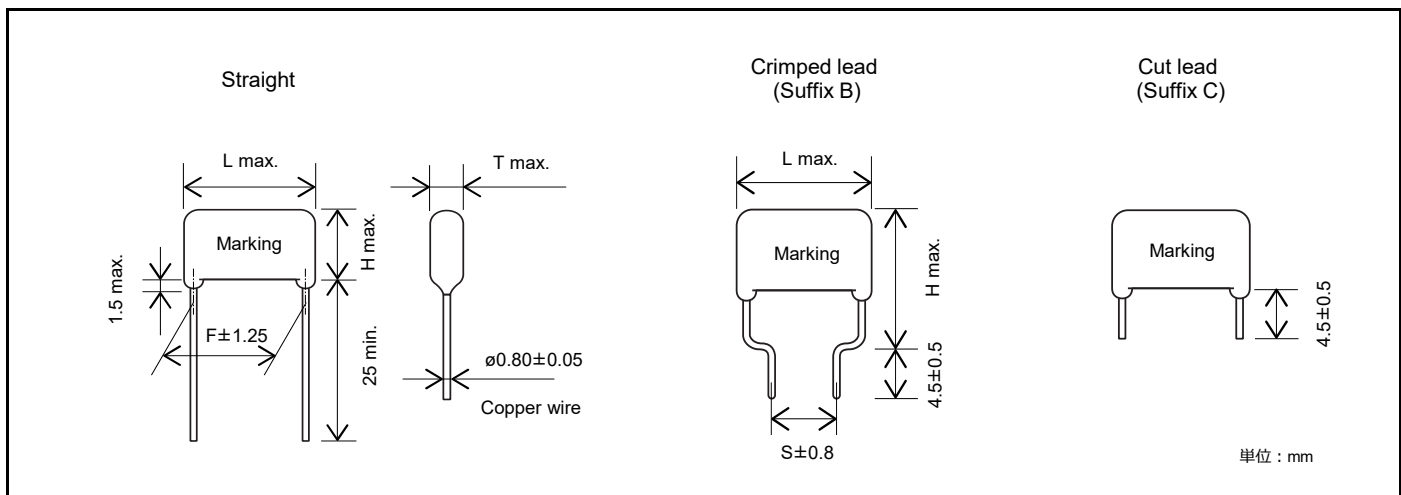

Packaging specifications for bulk package

- Packing quantity : 100 pcs./bag

Taping specifications for automatic insertion

- Taping style

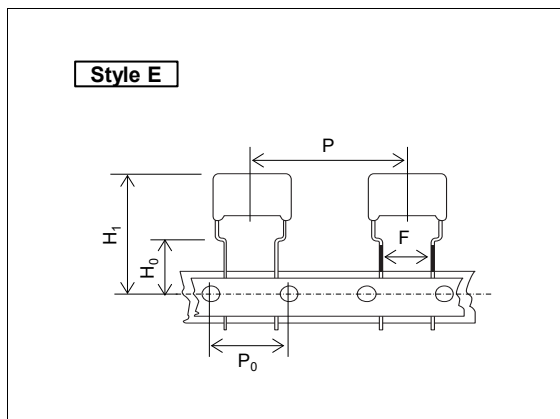

Size	Unit : mm
	Style
	E
P	30.0
P ₀	15.0
F	7.5
H ₀	16.0
H ₁ *	44.0

*:max.

* Please check the product drawing for the shape of the lead wire forming.

The above diagram shows the taping dimensions, and the lead wire forming shape is an example.

* H₁ dimension is based on insertion machine "Panaset RH series" made by Panasonic. Consult with Panasonic technical staff when using other insertion machines.

- Packaging specifications

Series	R.voltage (V) [DC]	Capacitance range (μF)	Taping style	Packing	Suffix
			E		
ECWH(V)	1000	0.0075 to 0.10	○	Ammo	R() V
	1250	0.0036 to 0.051	○	Ammo	R() V
	1600	0.0013 to 0.020	○	Ammo	R() V
	2000	0.0010 to 0.015	○	Ammo	R() V

- Lead spacing

Style	Lead spacing
E	7.5

See the column "Rating · Dimensions · Quantity" for packing quantity.

Rating · Dimensions · Quantity

■ Rated voltage [DC] : 1000 V, Capacitance tolerance : ±3 %(H), ±5 %(J)

Part No.	Capacitance (μF)	Dimensions (mm)							Min. order Q'ty (PCS)	
		L max.	T max.	H max.		F	S	ød	Taping	Bulk
				Straight	Crimped lead				7.5 mm	Straight·Crimped lead
ECWH10752□V()	0.0075	18.0	6.0	12.5	17.5	15.0	10.0	0.8	500	
ECWH10822□V()	0.0082	18.0	6.0	12.5	17.5	15.0	10.0	0.8		
ECWH10912□V()	0.0091	18.0	6.0	13.0	18.0	15.0	10.0	0.8		
ECWH10103□V()	0.010	18.0	6.5	13.0	18.0	15.0	10.0	0.8		
ECWH10113□V()	0.011	18.0	6.5	13.5	18.5	15.0	10.0	0.8		
ECWH10123□V()	0.012	18.0	6.5	13.5	18.5	15.0	10.0	0.8		
ECWH10133□V()	0.013	18.0	7.0	13.5	18.5	15.0	10.0	0.8		
ECWH10153□V()	0.015	18.0	7.0	14.0	19.0	15.0	10.0	0.8		
ECWH10163□V()	0.016	18.0	7.5	14.0	19.0	15.0	10.0	0.8		
ECWH10183□V()	0.018	18.0	7.5	14.5	19.5	15.0	10.0	0.8		
ECWH10203□V()	0.020	18.0	8.0	15.0	20.0	15.0	10.0	0.8	400	
ECWH10223□V()	0.022	18.0	8.5	15.0	20.0	15.0	10.0	0.8		
ECWH10243□V()	0.024	18.0	8.5	15.5	20.5	15.0	10.0	0.8		
ECWH10273□V()	0.027	18.0	9.0	16.0	21.0	15.0	10.0	0.8	300	500
ECWH10303□V()	0.030	18.0	9.5	16.5	21.5	15.0	10.0	0.8		
ECWH10333□V()	0.033	23.0	7.5	16.0	21.0	20.0	15.0	0.8	400	
ECWH10363□V()	0.036	23.0	7.5	16.0	21.0	20.0	15.0	0.8		
ECWH10393□V()	0.039	23.0	8.0	16.5	21.5	20.0	15.0	0.8		
ECWH10433□V()	0.043	23.0	8.5	16.5	21.5	20.0	15.0	0.8		
ECWH10473□V()	0.047	23.0	8.5	17.0	22.0	20.0	15.0	0.8		
ECWH10513□V()	0.051	23.0	9.0	17.5	22.5	20.0	15.0	0.8	300	
ECWH10563□V()	0.056	23.0	9.5	17.5	22.5	20.0	15.0	0.8		
ECWH10623□V()	0.062	23.0	9.5	18.0	23.0	20.0	15.0	0.8		
ECWH10683□V()	0.068	23.0	10.0	19.0	24.0	20.0	15.0	0.8		
ECWH10753□V()	0.075	23.0	10.5	19.5	24.5	20.0	15.0	0.8		
ECWH10823□V()	0.082	23.0	11.0	20.0	25.0	20.0	15.0	0.8		
ECWH10913□V()	0.091	23.0	11.5	20.5	25.5	20.0	15.0	0.8		
ECWH10104□V()	0.10	23.0	12.0	21.0	26.0	20.0	15.0	0.8		

* □ : Capacitance tolerance code
 () : Suffix for lead crimped or taped type

Rating · Dimensions · Quantity

■ Rated voltage [DC] : 1250 V, Capacitance tolerance : ±3 %(H), ±5 %(J)

Part No.	Capacitance (μF)	Dimensions (mm)							Min. order Qty (PCS)					
		L max.	T max.	H max.		F	S	ød	Taping	Bulk				
				Straight	Crimped lead				Straight	Crimped lead	7.5 mm	Straight	Crimped lead	
ECWH12362□V()	0.0036	18.0	6.0	12.5	17.5	15.0	10.0	0.8	500	500	500			
ECWH12392□V()	0.0039	18.0	6.0	12.5	17.5	15.0	10.0	0.8						
ECWH12432□V()	0.0043	18.0	6.0	13.0	18.0	15.0	10.0	0.8						
ECWH12472□V()	0.0047	18.0	6.0	13.0	18.0	15.0	10.0	0.8						
ECWH12512□V()	0.0051	18.0	6.5	13.0	18.0	15.0	10.0	0.8						
ECWH12562□V()	0.0056	18.0	6.5	13.5	18.5	15.0	10.0	0.8						
ECWH12622□V()	0.0062	18.0	6.5	13.5	18.5	15.0	10.0	0.8						
ECWH12682□V()	0.0068	18.0	7.0	13.5	18.5	15.0	10.0	0.8						
ECWH12752□V()	0.0075	18.0	7.0	14.0	19.0	15.0	10.0	0.8						
ECWH12822□V()	0.0082	18.0	7.5	14.0	19.0	15.0	10.0	0.8						
ECWH12912□V()	0.0091	18.0	7.5	14.5	19.5	15.0	10.0	0.8						
ECWH12103□V()	0.010	18.0	8.0	15.0	20.0	15.0	10.0	0.8				400	500	500
ECWH12113□V()	0.011	18.0	8.5	15.0	20.0	15.0	10.0	0.8						
ECWH12123□V()	0.012	18.0	8.5	15.5	20.5	15.0	10.0	0.8						
ECWH12133□V()	0.013	18.0	9.0	15.5	20.5	15.0	10.0	0.8						
ECWH12153□V()	0.015	18.0	9.5	16.0	21.0	15.0	10.0	0.8	500	500	500			
ECWH12163□V()	0.016	23.0	7.5	16.0	21.0	20.0	15.0	0.8						
ECWH12183□V()	0.018	23.0	7.5	16.0	21.0	20.0	15.0	0.8	400	500	500			
ECWH12203□V()	0.020	23.0	8.0	16.5	21.5	20.0	15.0	0.8						
ECWH12223□V()	0.022	23.0	8.5	16.5	21.5	20.0	15.0	0.8						
ECWH12243□V()	0.024	23.0	8.5	17.0	22.0	20.0	15.0	0.8						
ECWH12273□V()	0.027	23.0	9.0	17.5	22.5	20.0	15.0	0.8	300	500	500			
ECWH12303□V()	0.030	23.0	9.5	18.0	23.0	20.0	15.0	0.8						
ECWH12333□V()	0.033	23.0	10.0	18.5	23.5	20.0	15.0	0.8						
ECWH12363□V()	0.036	23.0	10.0	19.0	24.0	20.0	15.0	0.8	300	500	500			
ECWH12393□V()	0.039	23.0	10.5	19.5	24.5	20.0	15.0	0.8						
ECWH12433□V()	0.043	23.0	11.0	20.0	25.0	20.0	15.0	0.8						
ECWH12473□V()	0.047	23.0	11.5	20.5	25.5	20.0	15.0	0.8						
ECWH12513□V()	0.051	23.0	12.0	21.0	26.0	20.0	15.0	0.8	-	500	500			
ECWH12563□V()	0.056	28.0	11.5	20.0	25.0	25.0	17.5	0.8						
ECWH12623□V()	0.062	28.0	12.0	21.0	26.0	25.0	17.5	0.8						
ECWH12683□V()	0.068	28.0	12.5	21.5	26.5	25.0	17.5	0.8						
ECWH12753□V()	0.075	28.0	13.5	22.0	27.0	25.0	17.5	0.8						
ECWH12823□V()	0.082	28.0	14.0	22.5	27.5	25.0	17.5	0.8						
ECWH12913□V()	0.091	28.0	14.5	23.0	28.0	25.0	17.5	0.8						
ECWH12104□V()	0.10	28.0	15.5	24.0	29.0	25.0	17.5	0.8				400	500	500

* □ : Capacitance tolerance code
 () : Suffix for lead crimped or taped type

Rating · Dimensions · Quantity

■ Rated voltage [DC] : 1600 V, Capacitance tolerance : ±3 %(H), ±5 %(J)

Part No.	Capacitance (μF)	Dimensions (mm)							Min. order Qty (PCS)				
		L max.	T max.	H max.		F	S	ød	Taping	Bulk			
				Straight	Crimped lead				Straight	Crimped lead	7.5 mm	Straight	Crimped lead
ECWH16132□V()	0.0013	18.0	6.5	13.0	18.0	15.0	10.0	0.8	500				
ECWH16152□V()	0.0015	18.0	6.5	13.5	18.5	15.0	10.0	0.8					
ECWH16162□V()	0.0016	18.0	7.0	13.5	18.5	15.0	10.0	0.8					
ECWH16182□V()	0.0018	18.0	7.0	14.0	19.0	15.0	10.0	0.8					
ECWH16202□V()	0.0020	18.0	7.0	14.0	19.0	15.0	10.0	0.8					
ECWH16222□V()	0.0022	18.0	6.5	13.5	18.5	15.0	10.0	0.8					
ECWH16242□V()	0.0024	18.0	7.0	13.5	18.5	15.0	10.0	0.8					
ECWH16272□V()	0.0027	18.0	7.0	14.0	19.0	15.0	10.0	0.8					
ECWH16302□V()	0.003	18.0	7.5	14.0	19.0	15.0	10.0	0.8	400				
ECWH16332□V()	0.0033	18.0	7.5	14.5	19.5	15.0	10.0	0.8					
ECWH16362□V()	0.0036	18.0	7.0	13.5	18.5	15.0	10.0	0.8					
ECWH16392□V()	0.0039	18.0	7.0	14.0	19.0	15.0	10.0	0.8	500				
ECWH16432□V()	0.0043	18.0	7.0	14.0	19.0	15.0	10.0	0.8					
ECWH16472□V()	0.0047	23.0	6.5	14.5	19.5	20.0	15.0	0.8					
ECWH16512□V()	0.0051	23.0	6.5	15.0	20.0	20.0	15.0	0.8					
ECWH16562□V()	0.0056	23.0	6.5	15.0	20.0	20.0	15.0	0.8					
ECWH16622□V()	0.0062	23.0	7.0	15.0	20.0	20.0	15.0	0.8					
ECWH16682□V()	0.0068	23.0	7.0	15.5	20.5	20.0	15.0	0.8					
ECWH16752□V()	0.0075	23.0	7.5	15.5	20.5	20.0	15.0	0.8					
ECWH16822□V()	0.0082	23.0	7.5	16.0	21.0	20.0	15.0	0.8	400	500	500		
ECWH16912□V()	0.0091	23.0	8.0	16.0	21.0	20.0	15.0	0.8					
ECWH16103□V()	0.010	23.0	8.0	16.5	21.5	20.0	15.0	0.8					
ECWH16113□V()	0.011	23.0	8.5	17.0	22.0	20.0	15.0	0.8					
ECWH16123□V()	0.012	23.0	9.0	17.0	22.0	20.0	15.0	0.8	300				
ECWH16133□V()	0.013	23.0	9.0	17.5	22.5	20.0	15.0	0.8					
ECWH16153□V()	0.015	23.0	9.5	18.0	23.0	20.0	15.0	0.8					
ECWH16163□V()	0.016	23.0	10.0	18.5	23.5	20.0	15.0	0.8					
ECWH16183□V()	0.018	23.0	10.5	19.5	24.5	20.0	15.0	0.8					
ECWH16203□V()	0.020	23.0	11.0	20.0	25.0	20.0	15.0	0.8					
ECWH16223□V()	0.022	28.0	9.5	18.0	23.0	25.0	17.5	0.8	-				
ECWH16243□V()	0.024	28.0	10.0	18.5	23.5	25.0	17.5	0.8					
ECWH16273□V()	0.027	28.0	10.5	19.5	24.5	25.0	17.5	0.8					
ECWH16303□V()	0.030	28.0	11.0	20.0	25.0	25.0	17.5	0.8					
ECWH16333□V()	0.033	28.0	11.5	20.5	25.5	25.0	17.5	0.8					
ECWH16363□V()	0.036	28.0	12.5	21.5	26.5	25.0	17.5	0.8					
ECWH16393□V()	0.039	28.0	13.5	22.0	27.0	25.0	17.5	0.8					
ECWH16433□V()	0.043	28.0	14.5	22.5	27.5	25.0	17.5	0.8					
ECWH16473□V()	0.047	28.0	15.0	23.5	28.5	25.0	17.5	0.8					
ECWH16513□V()	0.051	28.0	15.5	24.0	29.0	25.0	17.5	0.8					
ECWH16563□V()	0.056	28.0	16.0	24.5	29.5	25.0	17.5	0.8					

* □ : Capacitance tolerance code
 () : Suffix for lead crimped or taped type

Rating · Dimensions · Quantity

■ Rated voltage [DC] : 2000 V, Capacitance tolerance : ±3 %(H), ±5 %(J)

Part No.	Capacitance (μF)	Dimensions (mm)							Min. order Q'ty (PCS)	
		L max.	T max.	H max.		F	S	ød	Taping	Bulk
				Straight	Crimped lead				7.5 mm	Straight·Crimped lead
ECWH20102□V()	0.0010	18.0	6.5	13.5	18.5	15.0	10.0	0.8	500	500
ECWH20112□V()	0.0011	18.0	6.5	13.5	18.5	15.0	10.0	0.8		
ECWH20122□V()	0.0012	18.0	7.0	13.5	18.5	15.0	10.0	0.8		
ECWH20132□V()	0.0013	18.0	7.0	14.0	19.0	15.0	10.0	0.8		
ECWH20152□V()	0.0015	18.0	7.5	14.0	19.0	15.0	10.0	0.8	400	
ECWH20162□V()	0.0016	18.0	7.5	14.5	19.5	15.0	10.0	0.8		
ECWH20182□V()	0.0018	18.0	8.0	14.5	19.5	15.0	10.0	0.8		
ECWH20202□V()	0.0020	18.0	8.0	15.0	20.0	15.0	10.0	0.8		
ECWH20222□V()	0.0022	18.0	8.5	15.0	20.0	15.0	10.0	0.8		
ECWH20242□V()	0.0024	18.0	8.5	15.5	20.5	15.0	10.0	0.8		
ECWH20272□V()	0.0027	18.0	9.0	16.0	21.0	15.0	10.0	0.8	300	
ECWH20302□V()	0.0030	18.0	9.5	16.0	21.0	15.0	10.0	0.8		
ECWH20332□V()	0.0033	18.0	8.5	15.5	20.5	15.0	10.0	0.8	400	
ECWH20362□V()	0.0036	18.0	9.0	15.5	20.5	15.0	10.0	0.8	300	
ECWH20392□V()	0.0039	18.0	9.0	16.0	21.0	15.0	10.0	0.8		
ECWH20432□V()	0.0043	18.0	9.5	16.0	21.0	15.0	10.0	0.8		
ECWH20472□V()	0.0047	23.0	7.0	15.5	20.5	20.0	15.0	0.8	500	
ECWH20512□V()	0.0051	23.0	7.5	16.0	21.0	20.0	15.0	0.8	400	
ECWH20562□V()	0.0056	23.0	7.5	16.0	21.0	20.0	15.0	0.8		
ECWH20622□V()	0.0062	23.0	8.0	16.5	21.5	20.0	15.0	0.8		
ECWH20682□V()	0.0068	23.0	8.5	16.5	21.5	20.0	15.0	0.8		
ECWH20752□V()	0.0075	23.0	9.5	18.0	23.0	20.0	15.0	0.8	300	
ECWH20822□V()	0.0082	23.0	10.0	18.0	23.0	20.0	15.0	0.8		
ECWH20912□V()	0.0091	23.0	10.0	19.0	24.0	20.0	15.0	0.8		
ECWH20103□V()	0.010	23.0	10.5	19.5	24.5	20.0	15.0	0.8		
ECWH20113□V()	0.011	23.0	11.0	20.0	25.0	20.0	15.0	0.8		
ECWH20123□V()	0.012	23.0	11.5	20.5	25.5	20.0	15.0	0.8		
ECWH20133□V()	0.013	23.0	12.0	21.0	26.0	20.0	15.0	0.8		
ECWH20153□V()	0.015	23.0	12.0	21.5	26.5	20.0	15.0	0.8		

* □ : Capacitance tolerance code
 () : Suffix for lead crimped or taped type

Specifications

Category temp. range (Including temperature-rise on unit surface)	-40 °C to +105 °C	
Rated voltage [DC]	800 V, 1600 V	
Capacitance range	800 V	0.010 μF to 0.047 μF
	1600 V	0.0010 μF to 0.047 μF
Capacitance tolerance	800 V	±3% (H)
	1600 V	±3% (H), ±5% (J)
Dissipation factor (tan δ)	tan δ ≤ 0.1 % (20 °C, 1 kHz)	
Withstand voltage	Between terminals : Rated voltage (V) × 150 % 60 s	
Insulation resistance (IR)	IR ≥ 30,000 MΩ (20 °C, 500 V, 60 s)	

* In case of applying voltage in alternating current (50 Hz or 60 Hz sine wave) to a capacitor with DC rated voltage, please refer to the page of "Permissible voltage (R.M.S) in alternating current corresponding to DC rated voltage".

Dimensions

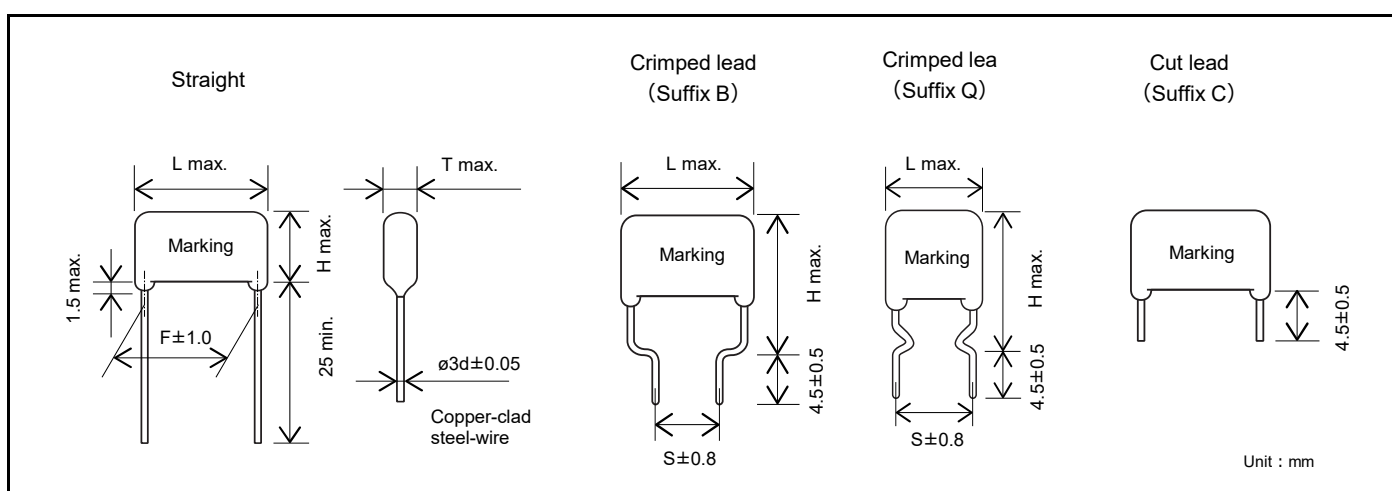

Packaging specifications for bulk package

- Packing quantity : 100 pcs./bag

Taping specifications for automatic insertion

- Taping style

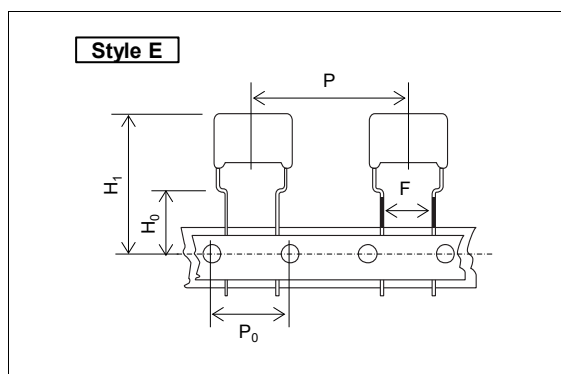

Size	Unit : mm
	Style
	E
P	30.0
P ₀	15.0
F	7.5
H ₀	16.0
H ₁ *	44.0

*:max.

* Please check the product drawing for the shape of the lead wire forming.

The above diagram shows the taping dimensions, and the lead wire forming shape is an example.

* H₁ dimension is based on insertion machine "Panaset RH series" made by Panasonic. Consult with Panasonic technical staff when using other insertion machines.

■ Packaging specifications

Series	R.voltage (V) [DC]	Capacitance range (μF)	Taping style	Packing	Suffix
			E		
ECWH(A)	800	0.010 to 0.047	○	Ammo	RHA
	1600	0.0010 to 0.047	○	Ammo	()4

● Lead spacing

Style	Lead spacing
E	7.5

Unit : mm

Refer to the page of taping specifications.

Rating · Dimensions · Quantity

■ Rated voltage [DC] : 800 V, Capacitance tolerance : ±3 % (H)

Part No.	Capacitance (μF)	Dimensions (mm)									Min. order Q'ty (PCS)	
		L max.	T max.	H max.			F	S		ød	Taping	Bulk
				Straight	Crimped lead (Suffix B)	Crimped lead (Suffix Q)		Crimped lead (Suffix B)	Crimped lead (Suffix Q)		7.5 mm	Straight·Crimped lead
ECWH8103HA()	0.010	15.4	5.4	9.8	14.8	14.8	12.5	7.5	12.5	0.6	500	500
ECWH8123HA()	0.012	15.4	5.8	10.2	15.2	15.2	12.5	7.5	12.5	0.6		
ECWH8153HA()	0.015	15.4	6.2	10.6	15.6	15.6	12.5	7.5	12.5	0.6		
ECWH8183HA()	0.018	15.7	6.6	11.0	16.0	18.0	12.5	7.5	12.5	0.8	400	
ECWH8223HA()	0.022	15.7	7.1	11.5	16.5	18.5	12.5	7.5	12.5	0.8		
ECWH8273HA()	0.027	15.7	7.6	12.0	17.0	19.0	12.5	7.5	12.5	0.8	300	
ECWH8333HA()	0.033	15.7	8.4	12.8	17.8	19.8	12.5	7.5	12.5	0.8		
ECWH8393HA()	0.039	15.7	8.9	13.3	18.3	20.3	12.5	7.5	12.5	0.8		
ECWH8473HA()	0.047	15.7	9.7	14.1	19.1	21.1	12.5	7.5	12.5	0.8		

* H : Capacitance tolerance code * () : Suffix for lead crimped or taped type

■ Rated voltage [DC] : 1600 V, Capacitance tolerance : ±3 % (H), ±5 % (J)

Part No.	Capacitance (μF)	Dimensions (mm)									Min. order Q'ty (PCS)		
		L max.	T max.	H max.			F	S		ød	Taping	Bulk	
				Straight	Crimped lead (Suffix B)	Crimped lead (Suffix Q)		Crimped lead (Suffix B)	Crimped lead (Suffix Q)		7.5 mm	Straight	Crimped lead
ECWHA3C102□()	0.0010	17.8	5.2	-	13.0	13.0	-	10.0	15.0	0.6	600	-	1000
ECWHA3C112□()	0.0011	17.8	5.4		13.1	13.1		10.0	15.0	0.6			
ECWHA3C122□()	0.0012	17.8	5.5		13.2	13.2		10.0	15.0	0.6			
ECWHA3C132□()	0.0013	17.8	5.7		13.4	13.4		10.0	15.0	0.6	500		
ECWHA3C152□()	0.0015	17.8	5.9		13.7	13.7		10.0	15.0	0.6			
ECWHA3C162□()	0.0016	17.8	6.1		13.9	13.9		10.0	15.0	0.6	400		
ECWHA3C182□()	0.0018	17.8	6.4		14.1	14.1		10.0	15.0	0.6			
ECWHA3C202□()	0.0020	17.8	6.6		14.3	14.3		10.0	15.0	0.6	400		
ECWHA3C222□()	0.0022	17.8	6.7		14.5	14.5		10.0	15.0	0.6			
ECWHA3C242□()	0.0024	17.8	7.0		14.7	14.7		10.0	15.0	0.6	600		
ECWHA3C272□()	0.0027	17.8	5.2		13.0	13.0		10.0	15.0	0.6			
ECWHA3C302□()	0.0030	17.8	5.5		13.2	13.2		10.0	15.0	0.6	500		
ECWHA3C332□()	0.0033	17.8	5.6	13.4	13.4	10.0	15.0	0.6					
ECWHA3C362□()	0.0036	17.8	5.7	13.5	13.5	10.0	15.0	0.6					
ECWHA3C392□()	0.0039	17.8	6.0	13.8	13.8	10.0	15.0	0.6	500				
ECWHA3C432□()	0.0043	17.8	6.2	13.9	13.9	10.0	15.0	0.6					
ECWHA3C472□()	0.0047	17.8	6.4	9.1	14.1	14.1	15.0	10.0	15.0	0.6	400	1000	
ECWHA3C512□()	0.0051	17.8	6.6	9.4	14.4	14.4	15.0	10.0	15.0	0.6			
ECWHA3C562□()	0.0056	17.8	6.8	9.6	14.6	14.6	15.0	10.0	15.0	0.6	400		
ECWHA3C622□()	0.0062	17.8	7.1	9.8	14.8	14.8	15.0	10.0	15.0	0.6			
ECWHA3C682□()	0.0068	17.8	6.1	12.1	17.1	17.1	15.0	10.0	15.0	0.6	500		
ECWHA3C752□()	0.0075	17.8	6.5	12.4	17.4	17.4	15.0	10.0	15.0	0.6			
ECWHA3C822□()	0.0082	17.8	6.8	12.7	17.7	17.7	15.0	10.0	15.0	0.6	400		
ECWHA3C912□()	0.0091	17.8	7.1	13.0	18.0	18.0	15.0	10.0	15.0	0.6			
ECWHA3C103□()	0.010	20.3	6.4	12.3	17.3	17.3	17.5	10.0	17.5	0.6	500		1000
ECWHA3C113□()	0.011	20.3	6.6	12.5	17.5	17.5	17.5	10.0	17.5	0.6			
ECWHA3C123□()	0.012	20.3	6.8	12.8	17.8	17.8	17.5	10.0	17.5	0.6	400		
ECWHA3C133□()	0.013	20.3	7.1	13.0	18.0	18.0	17.5	10.0	17.5	0.6			
ECWHA3C153□()	0.015	20.3	7.6	13.5	18.5	18.5	17.5	10.0	17.5	0.6	400		
ECWHA3C163□()	0.016	20.3	7.9	13.8	18.8	18.8	17.5	10.0	17.5	0.6			
ECWHA3C183□()	0.018	20.6	8.2	14.1	19.1	21.1	17.5	10.0	17.5	0.8	300		
ECWHA3C203□()	0.020	20.6	8.7	14.6	19.6	21.6	17.5	10.0	17.5	0.8			
ECWHA3C223□()	0.022	20.6	9.1	15.0	20.0	22.0	17.5	10.0	17.5	0.8	300		
ECWHA3C243□()	0.024	20.6	9.6	15.4	20.4	22.4	17.5	10.0	17.5	0.8			
ECWHA3C273□()	0.027	20.6	10.0	15.9	20.9	22.9	17.5	10.0	17.5	0.8	800		
ECWHA3C303□()	0.030	20.6	10.7	16.5	21.5	23.5	17.5	10.0	17.5	0.8			
ECWHA3C333□()	0.033	20.6	11.2	17.0	22.0	24.0	17.5	10.0	17.5	0.8	200		
ECWHA3C363□()	0.036	20.6	11.7	17.5	22.5	24.5	17.5	10.0	17.5	0.8			
ECWHA3C393□()	0.039	20.6	12.1	18.0	23.0	25.0	17.5	10.0	17.5	0.8	200		
ECWHA3C433□()	0.043	20.6	12.8	18.6	23.6	25.6	17.5	10.0	17.5	0.8			
ECWHA3C473□()	0.047	20.6	13.4	19.2	24.2	26.2	17.5	10.0	17.5	0.8	600	800	

* □ : Capacitance tolerance code * () : Suffix for lead crimped or taped type

Plastic Film Capacitors

Metallized Polypropylene Film Capacitor

ECWH(C) series

Non-inductive construction using metallized polypropylene film with flame retardant epoxy resin coating

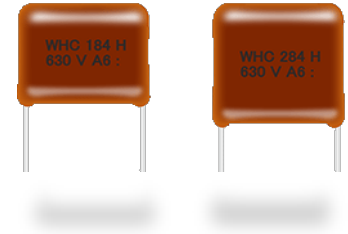

Features

- Excellent electrical characteristics
- Low loss
- Flame-retardant epoxy resin coating
- RoHS compliant

Recommended applications

- General resonance circuit (630 V, 1250 V)
- Resonance circuit for microwave oven and IH cooker (630 V, 1250 V)
- General high voltage circuit (3000 V)

Explanation of part number

● Rated voltage 630 V (Bulk)

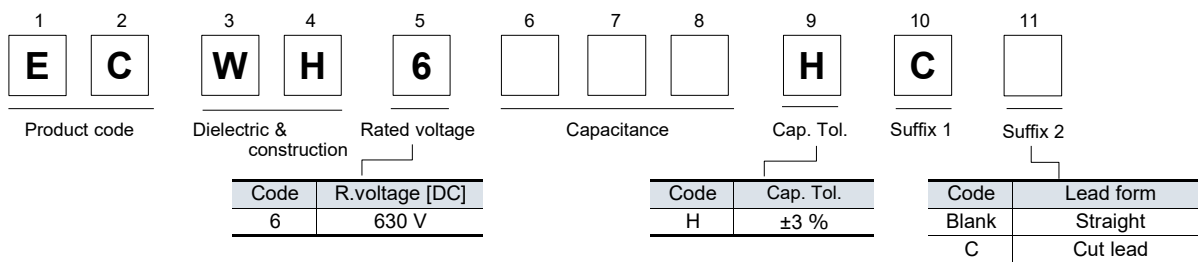

● Rated voltage 630 V (Odd size taping)

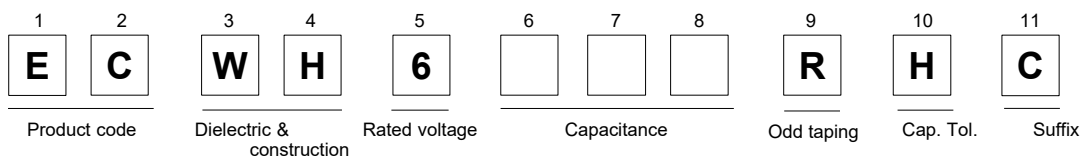

● Rated voltage 1250 V (Cut lead)

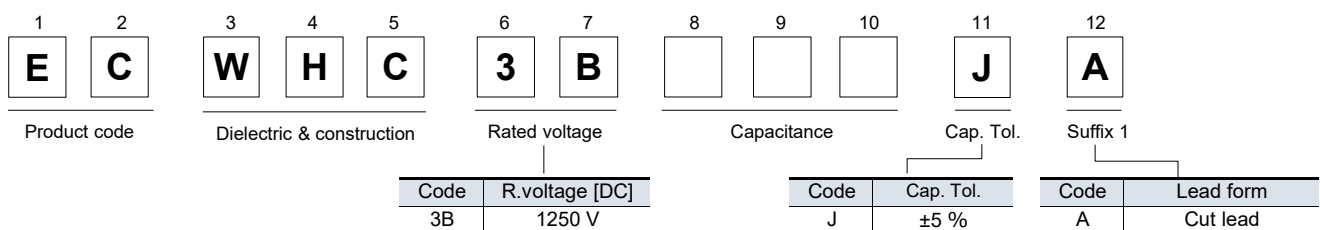

● Rated voltage 3000 V (Bulk)

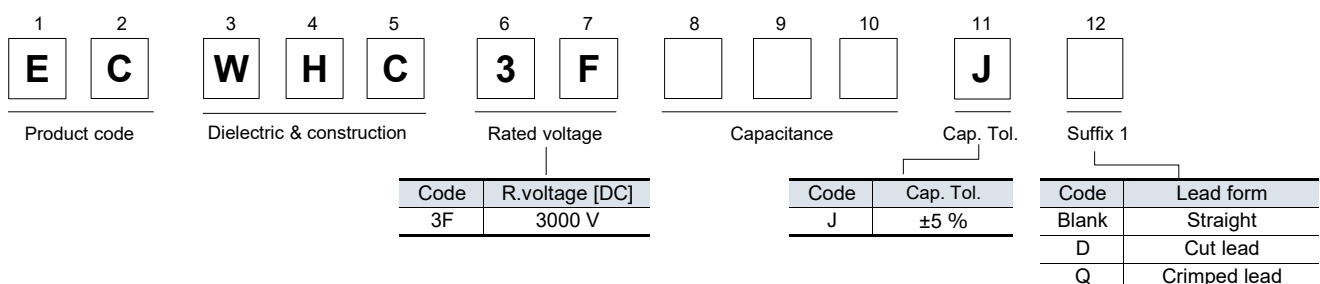

Specifications

Category temp. range (Including temperature-rise on unit surface)	630 V	-40 °C to +105 °C : General resonance circuit -40 °C to +85 °C : When using compulsive air cooling for a resonance circuit
	1250 V	-40 °C to +105 °C : General resonance circuit -40 °C to +85 °C : When using compulsive air cooling for a resonance circuit
	3000 V	-40 °C to +85 °C : General resonance circuit
Rated voltage [DC]	630 V, 1250 V, 3000 V	
Capacitance range	630 V	0.10 μF to 0.33 μF
	1250 V	0.08 μF to 0.12 μF
	3000 V	0.0024 μF to 0.01 μF
Capacitance tolerance	630 V	±3% (H)
	1250 V	±5% (J)
	3000 V	±5% (J)
Dissipation factor (tan δ)	630 V	tan δ ≤ 0.05% (20 °C, 1 kHz)
	1250 V	tan δ ≤ 0.1% (20 °C, 10 kHz)
	3000 V	tan δ ≤ 0.1% (20 °C, 1 kHz), tan δ ≤ 0.1% (20 °C, 10 kHz)
Withstand voltage	630 V	Between terminals : Rated voltage (V) × 150% 60 s
	1250 V	
	3000 V	Between terminals : Rated voltage : 6615 V [DC] 3 s
Insulation resistance (IR)	630 V	IR ≥ 30,000 MΩ (20 °C, 500 V, 60 s)
	1250 V	
	3000 V	

* In case of applying voltage in alternating current (50 Hz or 60 Hz sine wave) to a capacitor with DC rated voltage, please refer to the page of "Permissible voltage (R.M.S) in alternating current corresponding to DC rated voltage".

Dimensions

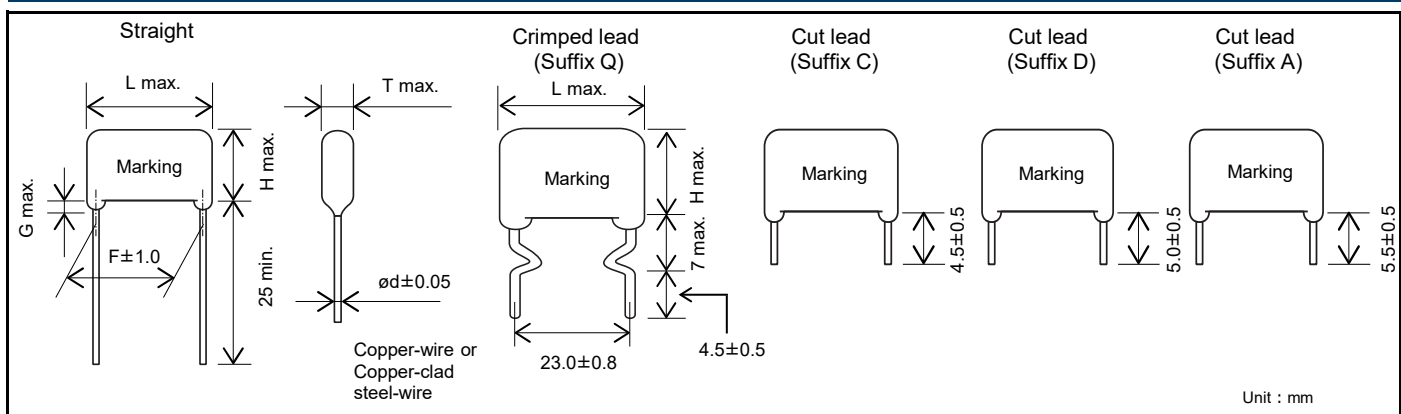

Packaging specifications for bulk package

- Packing quantity : 100 pcs./bag

Taping specifications for automatic insertion

- Taping style

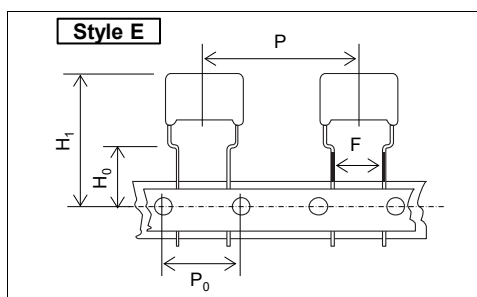

* Please check the product drawing for the shape of the lead wire forming. The above diagram shows the taping dimensions, and the lead wire forming shape is an example.

* H₁ dimension is based on insertion machine "Panaset RH series" made by Panasonic. Consult with Panasonic technical staff when using other insertion machines.

Size	Unit : mm
	Style
	E
P	30.0
P ₀	15.0
F	7.5
H ₀	16.0
H ₁ *	44.0

*.max.

- Packaging specifications

Series	R.voltage (V) [DC]	Capacitance range (μF)	Taping style	Packing
			E	
ECWH(C)	630	0.10 ~ 0.21	○	Ammo

See the column "Rating · Dimensions · Quantity" for packing quantity.

- Lead spacing

Style	Lead spacing
E	7.5

Unit : mm

Rating · Dimensions · Quantity

■ Rated voltage [DC] : 630 V, Capacitance tolerance : ±3 %(H)

Part No.	Capacitance (μF)	Dimensions (mm)						Min. order Q'ty (PCS)	
		L max.	T max.	H max.	F	G max.	ød	Taping	Bulk
								7.5 mm	Straight·Crimped lead
ECWH6104HC()	0.10	20.7	8.6	13.5	17.5	1.5	0.8	350	1000
ECWH6114HC()	0.11	20.7	9.0	13.9	17.5	1.5	0.8	300	
ECWH6124HC()	0.12	20.7	9.4	14.3	17.5	1.5	0.8	250	
ECWH6184HC()	0.18	20.7	11.5	16.3	17.5	1.5	0.8	200	
ECWH6214HC()	0.21	20.7	12.4	17.2	17.5	1.5	0.8	-	
ECWH6244HC()	0.24	20.7	13.2	18.1	17.5	1.5	0.8	-	700
ECWH6274HC()	0.27	20.7	14.0	18.9	17.5	1.5	0.8	-	
ECWH6284HC()	0.28	20.7	14.3	19.1	17.5	1.5	0.8	-	
ECWH6304HC()	0.30	20.7	14.8	19.6	17.5	1.5	0.8	-	
ECWH6324HC()	0.32	20.7	14.5	20.9	17.5	1.5	0.8	-	
ECWH6334HC()	0.33	20.7	14.7	21.1	17.5	1.5	0.8	-	-

() : Suffix for lead crimped or taped type

■ Rated voltage [DC] : 1250 V, Capacitance tolerance : ±5 %(J)

Part No.	Capacitance (μF)	Dimensions (mm)						Min. order Q'ty (PCS)	
		L max.	T max.	H max.	F	G max.	ød	Bulk	Straight·Crimped lead
ECWHC3B803JA	0.08	20.7	12.0	19.0	17.5	1.5	0.8	700	
ECWHC3B104JA	0.10	20.7	13.5	20.6	17.5	1.5	0.8		
ECWHC3B114JA	0.11	20.7	14.2	21.3	17.5	1.5	0.8		600
ECWHC3B124JA	0.12	20.7	14.9	21.9	17.5	1.5	0.8		

■ Rated voltage [DC] : 3000 V, Capacitance tolerance : ±5 %(J)

Part No.	Capacitance (μF)	Dimensions (mm)							Min. order Q'ty (PCS)	
		L max.	T max.	H max.	F	S	G max.	ød	Bulk	Straight·Crimped lead
						Crimped lead (Suffix Q)				
ECWHC3F242J()	0.0024	25.8	6.1	10.9	22.5	23.0	1.5	0.8	1000	
ECWHC3F362J()	0.0036	25.8	7.2	11.9	22.5	23.0	1.5	0.8		
ECWHC3F392J()	0.0039	25.8	7.5	12.2	22.5	23.0	1.5	0.8		
ECWHC3F432J()	0.0043	25.8	6.5	11.2	22.5	23.0	1.5	0.8		
ECWHC3F562J()	0.0056	25.8	7.3	12.0	22.5	23.0	1.5	0.8		
ECWHC3F822J()	0.0082	25.8	7.5	15.3	22.5	23.0	1.5	0.8		
ECWHC3F103J()	0.01	25.8	8.2	16.1	22.5	23.0	1.5	0.8		

() : Suffix for lead crimped or taped type



Plastic Film Capacitors

Metallized Polypropylene Film Capacitor

TMF series (for smoothing and resonance)

Features

- Wide voltage range up to 2300 V [AC]
- High frequency and high current capability
- Low loss, Low ESR
- Long life time, High reliability
- Flame retardant
- RoHS compliant

Recommended applications

- Smoothing and resonance circuit, IH equipment and Industrial power supply

Construction

- Dielectric : Polypropylene film
- Electrodes : Metallized plastic film
- Plastic case : UL94 V-0
- Sealing : UL94 V-0
- Terminal : Lead wire (tin plating), Plate terminal (tin plating)

Explanation of part number

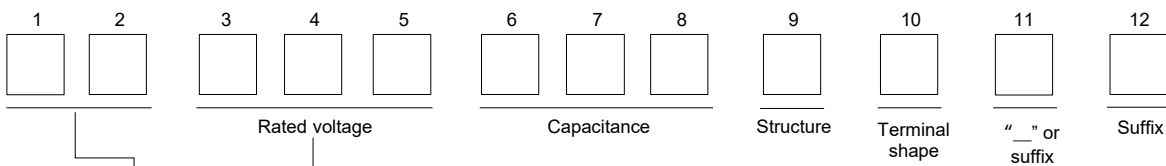

Code	Type	Code	Rated voltage
KS	Resonance use	351	350 V
SS	Smoothing use	202	2000 V

(Ex.)
Note) Definition of AC or DC, please refer to an individual drawing

Specifications

Rated voltage*1	Smoothing circuit		Resonance circuit	
	150 V to 220 V [AC]	300 V to 2300 V [AC]	350 V to 630 V [DC]	500 V to 1200 V [DC]
Rated capacitance*1	150 V to 220 V [AC]	1 μF to 10 μF	300 V to 2300 V [AC]	0.01 μF to 4.0 μF
	350 V to 630 V [DC]	1 μF to 10 μF	500 V to 1200 V [DC]	0.01 μF to 4.0 μF
Capacitance tolerance	Please refer to an individual drawing			
Withstand voltage	Please refer to an individual drawing			
Insulation resistance (IR)	Please refer to an individual drawing			
Maximum permissible temperature (Case wall)	85 °C (Including self temperature rising)			

*1 : These are typical values. Please contact if necessary other Voltage and Capacitance.

 This series is not a recommended product.
Not recommended for new design.

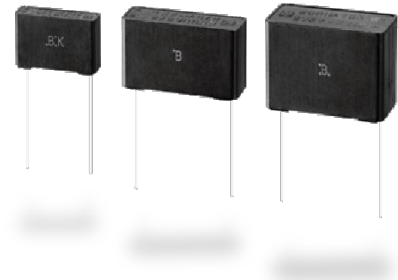

Plastic Film Capacitors

Metallized Polypropylene Film Capacitor

ECQUA series [Class X2]

In accordance with UL/CSA and European safety regulation class X2 equipped with a safety mechanism.

Features

- High safety (safety function installed)
- High humidity resistance (THB test : 85 °C, 85 %, 240 V [AC], 1000 h (0.1 ≤ C ≤ 1.0 μF), 275 V [AC] / 500 h)
- Compact
- Flame-retardant plastic case and non-combustible resin
- RoHS compliant

Recommended applications

- Interference suppressors

Explanation of part number

■ Standard

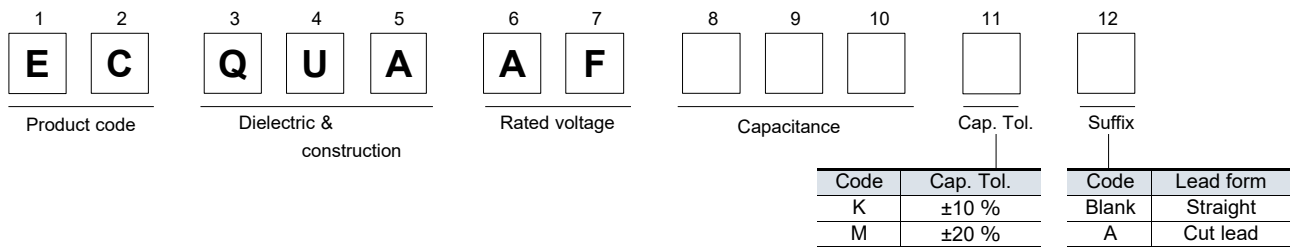

■ Special lead space product

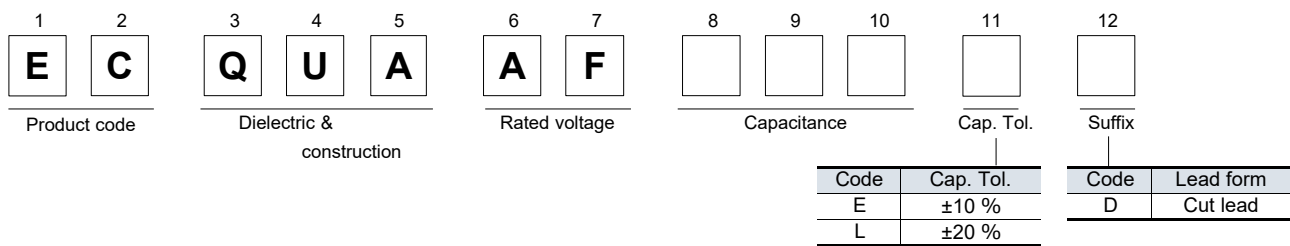

Applicable standard

* It is certified as type ECQUA in the following approval.

Approval		Class	Certification organization
UL	UL60384-14	Class X2	UL
CSA	CAN/CSA E60384-14	Class X2	
Europe	EN60384-14	Class X2	VDE or DEMKO
International	IEC60384-14	Class X2	

* When applying this capacitor to European and American safety standards, please use type designation and rating such as ECQUA, 0.1 μF.

* Approval number (File No.) of safety regulations are subject to revision without notice. Ask factory for a copy of the latest file No.

Specifications

Category temp. range	-40 °C to +110 °C
Rated voltage [AC]	275 V
Capacitance range	0.0082 μF to 10.0 μF
Capacitance tolerance	±10 % (K), ±20 % (M)
Dissipation factor (tan δ)	C ≤ 1.0 μF : tan δ ≤ 0.1 % (20 °C, 1 kHz) C > 1.0 μF : tan δ ≤ 0.2 % (20 °C, 1 kHz)
Withstand voltage	Between terminals : 633 V [AC], 1183 V [DC], 60 s Between terminals to enclosure : 2050 V [AC], 60 s
Insulation resistance (IR)	C ≤ 0.33 μF : IR ≥ 15,000 MΩ (20 °C, 100 V [DC], 60 s) C > 0.33 μF : IR ≥ 5,000 MΩ · μF (20 °C, 100 V [DC], 60 s) C ≤ 0.47 μF : IR ≥ 2,000 MΩ (20 °C, 500 V [DC], 60 s)
Maximum AC voltage * *	310 V [AC]

* Use of this capacitor is limited to AC voltage (50 Hz or 60 Hz sine wave).

* A faint corona discharge may occur inside of the capacitor element at rated voltage, however there is no influence on the reliability of the capacitor.

* * Maximum AC voltage including line voltage fluctuation is 310 V [AC].

310 V [AC] is not nominal continuous applied voltage, but only indicates maximum value including in the voltage of the power supply.

Basic nominal voltage is considered as 240 V [AC].

This maximum AC voltage is specified in only ECQUA type, not specified in other types.

Please refer to individual product specification, and contact us for further questions regarding design life.

Dimensions

Technical drawings showing dimensions: L±0.5, T±0.5, H±0.5, F±0.4, 20 min., ød±0.05, 4.0±0.5, Q +1.4/-0.6, P (Lead location limits from center). Marking example table:

Style	(A) side	(B) or (C) side
1	ECQUA103K	15 275V~X2 c RA us
2	ECQUA104 275V~X2	10 K c RA us
3	ECQUA106 275V~X2	15 K c RA us

Note: Only ±10 % as cap. tol. be marked as "K".
Note: □ Date code.

Unit:mm

Rating · Dimensions · Quantity

● Capacitance tolerance : ±10 %(K), ±20 %(M)

Part No.	Cap. (µF)	Dimensions (mm)							Style	Min. order Q'ty (PCS)	
		L	T	H	F	ød	P	Q		Straight	Cut lead
		ECQUAAF822□()	0.0082	15.3	5.0	11.5	12.5	0.6			
ECQUAAF103□()	0.01	15.3	5.0	11.5	12.5	0.6	0±0.8	1.5	1	1000	1000
ECQUAAF123□()	0.012	15.3	5.0	11.5	12.5	0.6	0±0.8	1.5	1	1000	1000
ECQUAAF153□()	0.015	15.3	5.0	11.5	12.5	0.6	0±0.8	1.5	1	1000	1000
ECQUAAF183□()	0.018	15.3	5.0	11.5	12.5	0.6	0±0.8	1.5	1	1000	1000
ECQUAAF223□()	0.022	15.3	5.0	11.5	12.5	0.6	0±0.8	1.5	1	1000	1000
ECQUAAF273□()	0.027	15.3	5.0	11.5	12.5	0.6	0±0.8	1.5	1	1000	1000
ECQUAAF333□()	0.033	15.3	5.0	11.5	12.5	0.6	0±0.8	1.5	1	1000	1000
ECQUAAF393□()	0.039	15.3	5.0	11.5	12.5	0.6	0±0.8	1.5	1	1000	1000
ECQUAAF473□()	0.047	15.3	6.0	13.0	12.5	0.6	0±0.8	1.5	1	1000	1000
ECQUAAF563□()	0.056	17.5	5.0	12.0	15.0	0.6	0±0.8	1.3	1	1000	1000
ECQUAAF683□()	0.068	17.5	5.0	12.0	15.0	0.6	0±0.8	1.3	1	1000	1000
ECQUAAF823□()	0.082	17.5	5.0	12.0	15.0	0.6	0±0.8	1.3	1	1000	1000
ECQUAAF104□()	0.10	17.5	5.0	12.0	15.0	0.6	0±0.8	1.3	2	1000	1000
ECQUAAF124□()	0.12	17.5	6.0	13.0	15.0	0.6	0±0.8	1.3	1	1000	1000
ECQUAAF154□()	0.15	17.5	6.0	13.0	15.0	0.6	0±0.8	1.3	2	1000	1000
ECQUAAF184□()	0.18	17.5	7.5	14.0	15.0	0.6	0±0.8	1.3	1	1000	1000
ECQUAAF224□()	0.22	17.5	7.5	14.0	15.0	0.6	0±0.8	1.3	2	1000	1000
ECQUAAF274□()	0.27	17.5	9.0	16.0	15.0	0.6	0±0.8	1.3	1	1000	800
ECQUAAF334□()	0.33	17.5	9.0	16.0	15.0	0.6	0±0.8	1.3	2	1000	800
ECQUAAF394□()	0.39	26.0	8.5	15.0	22.5	0.8	0±0.8	1.8	1	600	800
ECQUAAF474□()	0.47	26.0	8.5	15.0	22.5	0.8	0±0.8	1.8	2	600	800
ECQUAAF564□()	0.56	26.0	10.0	17.0	22.5	0.8	0±0.8	1.8	1	500	500
ECQUAAF684□()	0.68	26.0	10.0	17.0	22.5	0.8	0±0.8	1.8	2	500	500
ECQUAAF824□()	0.82	26.0	12.0	19.0	22.5	0.8	0±0.8	1.8	1	300	300
ECQUAAF105□()	1.0	26.0	12.0	19.0	22.5	0.8	0±0.8	1.8	2	300	300
ECQUAAF125□()	1.2	31.0	12.0	22.0	27.5	0.8	0±0.8	1.8	1	200	200
ECQUAAF155□()	1.5	31.0	12.0	22.0	27.5	0.8	0±0.8	1.8	2	200	200
ECQUAAF185□()	1.8	31.0	14.5	24.5	27.5	0.8	0±0.8	1.8	1	200	200
ECQUAAF225□()	2.2	31.0	14.5	24.5	27.5	0.8	0±0.8	1.8	2	200	200
ECQUAAF275□()	2.7	31.0	19.0	29.0	27.5	0.8	0±0.8	1.8	1	150	150
ECQUAAF335□()	3.3	31.0	19.0	29.0	27.5	0.8	0±0.8	1.8	2	150	150
ECQUAAF335ED	3.3	41.0	15.0	30.0	37.5	1.0	0±0.8	1.8	3	—	90
ECQUAAF335LD											
ECQUAAF475□()	4.7	31.0	23.0	33.0	27.5	0.8	0±0.8	1.8	2	100	100
ECQUAAF475ED	4.7	41.0	18.0	33.0	37.5	1.0	0±0.8	1.8	3	—	75
ECQUAAF475LD											
ECQUAAF685□A	6.8	41.0	23.0	37.5	37.5	1.0	0±0.8	1.8	3	—	60
ECQUAAF106□A	10.0	41.0	28.0	42.5	37.5	1.0	0±0.8	1.8	3	—	50

* □ : Capacitance tolerance code

() : Suffix for lead crimped

Note) Part number marked with bold is special lead space product.

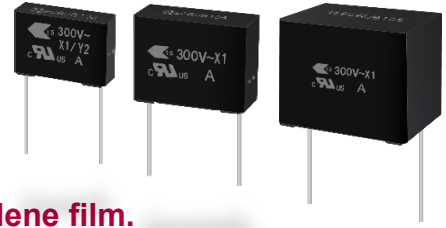

Plastic Film Capacitors

Metallized Polypropylene Film Capacitor

ECQUB series [Class Y2/X1] [Class X1]

Non-inductive construction using metallized polypropylene film.
Flame-retardant plastic case and non-combustible resin.

Features

- High safety (with safety function)[Class X1]
- High moisture resistance 85°C, 85%, 275 V [AC] 500 h
- Flame-retardant plastic case and non-combustible resin
- RoHS compliant

Recommended applications

- Interference suppressors for electronic equipment

Explanation of part number

■ Standard

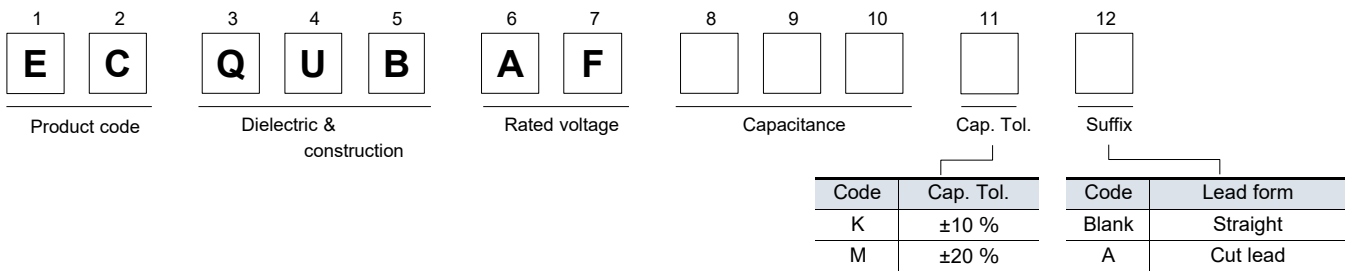

■ Special lead space product

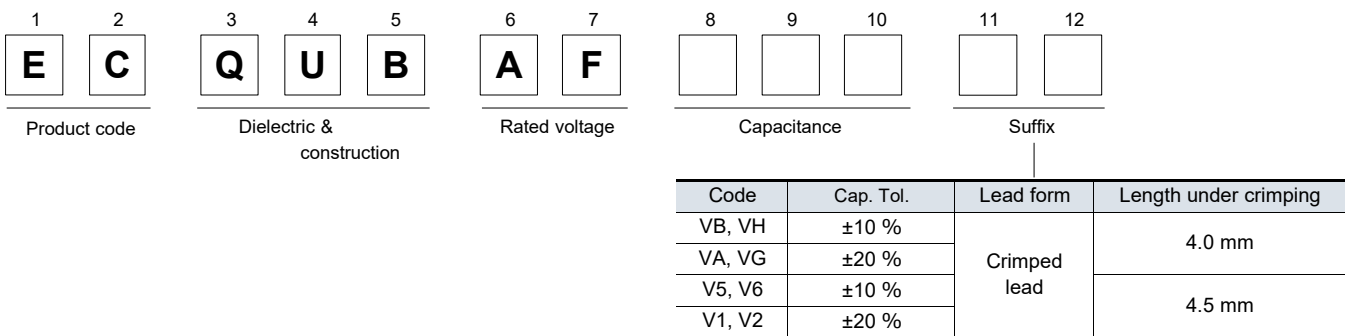

Applicable standard

* It is certified as type ECQUB in the following approval.

Approval		Class		Certification organization
UL	UL60384-14	Class Y2 / X1	0.001 μF to 0.0068 μF	UL
		Class X1	0.01 μF to 1.0 μF	
CSA	CAN/CSA E60384-14	Class Y2 / X1	0.001 μF to 0.0068 μF	UL
		Class X1	0.01 μF to 1.0 μF	
Europe	EN60384-14	Class Y2 / X1	0.001 μF to 0.0068 μF	DEMKO
		Class X1	0.01 μF to 1.0 μF	

* When applying this capacitor to European and American safety standards, please use type designation and rating such as ECQUB, 0.1 μF.

* Approval number (File No.) of safety regulations are subject to revision without notice. Ask factory for a copy of the latest file No.

* According to standards for each region are based on IEC60384-14.

Specifications

Category temp. range	-40 °C to +110 °C	
Rated voltage [AC]	300 V 300 V mentioned above refers to maximum voltage by fluctuating of nominal power supply voltage of 240 V.	
Capacitance range	0.001 μF to 1.0 μF (0.001 μF to 0.0068 μF (E12), 0.01 μF to 1.0 μF (E6))	
Capacitance tolerance	±10% (K), ±20% (M)	
Dissipation factor (tan δ)	tan δ ≤ 0.1 % (20 °C, 1 kHz)	
Withstand voltage	Between terminals	C ≤ 0.0068 μF : 1600 V [AC], 2121 V [DC], 60 s 0.0068 μF < C ≤ 1.0 μF : 690 V [AC], 1768 V [DC], 60 s
	Between terminals to enclosure	2100 V [AC], 60 s The capacitor shall be applied the voltage through a resistor of 2 kΩ or more when charge and discharge.
Insulation resistance (IR)	Between terminals	C ≤ 0.33 μF : 15000 MΩ or more at 100 V [DC] C > 0.33 μF : 5000 MΩ·μF or more at 100 V [DC] C ≤ 0.47 μF : 2000 MΩ or more at 500 V [DC]
	Between terminals to enclosure	30000 MΩ or more at 100 V [DC] 500 MΩ 以上 at 500 V [DC]

* Use of this capacitor is limited to AC voltage (50 Hz or 60 Hz sine wave).

* A faint corona discharge may occur inside of the capacitor element at rated voltage, however there is no influence on the reliability of the capacitor.

Dimensions

The diagram shows four types of capacitor leads: Straight, Cut lead (Suffix A), Crimped lead (Suffix VB, VH, VA, VG), and Crimped lead (Suffix V5, V6, V1, V2). Dimensions are given in millimeters. Key dimensions include length (L±0.5), height (H±0.5), lead width (F±0.4), lead thickness (T±0.5), lead diameter (Φd±0.05), and crimp width (S±0.8). A note indicates the use of tin-plated copper-clad steel wire. A marking example table is provided below the drawings.

Style	(A) side	(B) side
1	ECQUB102 K	15 300 V~ c R US X1 / Y2
2	ECQUB103 K	15 300 V~ X1

Note : Only ±10 % as cap. tol. be marked as "K".
Note: □ Date code.

Unit : mm

Rating · Dimensions · Quantity

Part No.	Cap. (μ F)	Dimensions (mm)								STYLE	Min. order Q'ty (PCS)		
		L	T	H	F	S	ϕ d	P	Q		Straight	Cut lead	Crimped lead
					Straight Cut lead	Crimped lead							
ECQUBAF102□() ECQUBAF102V◇	0.001	15.3	5.0	11.5	12.5	15.0	0.6	0±0.8	1.4	1	1000	1000	1000
ECQUBAF122□() ECQUBAF122V◇	0.0012	15.3	5.0	11.5	12.5	15.0	0.6	0±0.8	1.4	1	1000	1000	1000
ECQUBAF152□() ECQUBAF152V◇	0.0015	15.3	5.0	11.5	12.5	15.0	0.6	0±0.8	1.4	1	1000	1000	1000
ECQUBAF182□() ECQUBAF182V◇	0.0018	15.3	5.0	11.5	12.5	15.0	0.6	0±0.8	1.4	1	1000	1000	1000
ECQUBAF222□() ECQUBAF222V◇	0.0022	15.3	5.0	11.5	12.5	15.0	0.6	0±0.8	1.4	1	1000	1000	1000
ECQUBAF272□() ECQUBAF272V◇	0.0027	15.3	5.0	11.5	12.5	15.0	0.6	0±0.8	1.4	1	1000	1000	1000
ECQUBAF332□() ECQUBAF332V◇	0.0033	15.3	5.0	11.5	12.5	15.0	0.6	0±0.8	1.4	1	1000	1000	1000
ECQUBAF392□() ECQUBAF392V◇	0.0039	15.3	5.0	11.5	12.5	15.0	0.6	0±0.8	1.4	1	1000	1000	1000
ECQUBAF472□() ECQUBAF472V◇	0.0047	15.3	5.0	11.5	12.5	15.0	0.6	0±0.8	1.4	1	1000	1000	1000
ECQUBAF562□() ECQUBAF562V◇	0.0056	15.3	5.0	11.5	12.5	15.0	0.6	0±0.8	1.4	1	1000	1000	1000
ECQUBAF682□() ECQUBAF682V◇	0.0068	15.3	5.0	11.5	12.5	15.0	0.6	0±0.8	1.4	1	1000	1000	1000
ECQUBAF103□() ECQUBAF103V◆	0.01	18.5	5.0	9.5	15.0	12.5	0.6	0±0.8	1.8	2	1000	1000	1000
ECQUBAF153□() ECQUBAF153V◆	0.015	18.5	6.0	10.5	15.0	12.5	0.6	0±0.8	1.8	2	1000	1000	1000
ECQUBAF223□() ECQUBAF223V◆	0.022	18.5	6.0	10.5	15.0	12.5	0.6	0±0.8	1.8	2	1000	1000	1000
ECQUBAF333□() ECQUBAF333V◆	0.033	18.5	6.0	10.5	15.0	12.5	0.6	0±0.8	1.8	2	1000	1000	1000
ECQUBAF473□() ECQUBAF473V◆	0.047	18.5	7.0	11.5	15.0	12.5	0.6	0±0.8	1.8	2	1000	1000	1000
ECQUBAF683□() ECQUBAF683V◆	0.068	18.5	8.0	12.5	15.0	12.5	0.6	0±0.8	1.8	2	1000	1000	1000
ECQUBAF104□() ECQUBAF104V◆	0.1	18.5	8.0	16.5	15.0	12.5	0.6	0±0.8	1.8	2	1000	1000	1000
ECQUBAF154□()	0.15	18.5	9.0	18.0	15.0	-	0.8	0±0.8	1.8	2	1000	1000	-
ECQUBAF224□()	0.22	18.5	11.0	20.0	15.0		0.8	0±0.8	1.8	2	500	500	
ECQUBAF334□()	0.33	26.0	12.0	19.0	22.5		0.8	0±0.8	1.8	2	300	300	
ECQUBAF474□()	0.47	26.0	14.0	21.0	22.5		0.8	0±0.8	1.8	2	200	200	
ECQUBAF684□()	0.68	26.0	16.0	23.0	22.5		0.8	0±0.8	1.8	2	200	200	
ECQUBAF105□()	1.0	26.0	19.0	26.0	22.5		0.8	0±0.8	1.8	2	200	200	

- * □ : Capacitance tolerance code
- () : Suffix for lead crimped
- ◇ : Special lead space product B, A, 5, or 1
- ◆ : Special lead space product H, G, 6, or 2



Plastic Film Capacitors

Film Capacitor for AC Motor

DMF series

Features

- High safety (with built-in safety device)
- High reliability, Safety standard approval
- Small size, lightness, and low loss
- RoHS compliant

Recommended applications

- Motor and compressor (for running)

Construction

- Internal electrode : Metallized plastic film
- Exterior material : Metal case (oil sealing up type)
- Terminal : Faston terminal (tin plating)

Explanation of part number

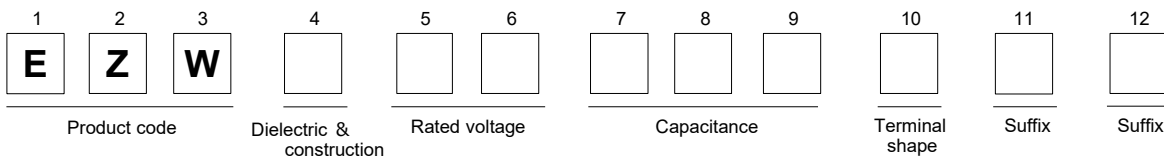
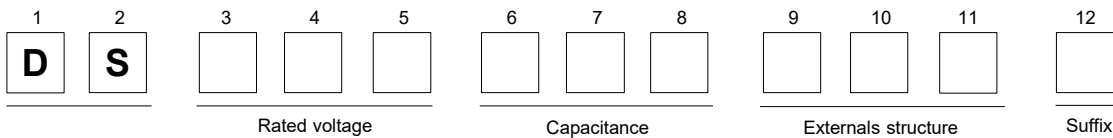

Applicable standard

Japan	JIS C 4908 Capacitors for electrical apparatus CMJ registration parts. Registration No.1475- C9902-026(JET)
UL/cUL	UL810/CSA C22.2 No.190 FILE No.E76560
Europe	EN60252-1 AC motor Capacitors TUV
China	GB/T 3667.1 AC motor Capacitors CQC

Specifications

Applicable standard*1		JIS UL	EN GB
Safety class		With built-in safety device P1 (CMJ approval) 10000 AFC (UL)	S2
Rated voltage (50/60 Hz)*2 [AC]		180 V to 450 V	440 V, 450 V
Rated capacitance*2		10 μF to 60 μF	
Capacitance tolerance		-5 % / +10 %, ±5 % (Refer to the individual drawing)	
Withstand voltage	Between terminals	Rated voltage×1.75 60 s	Rated voltage×2.0 60 s
	Between terminals to enclosure	(min. 2000 V [AC]) Rated voltage × 2.0 + 1000 V [AC] 60 s	
Maximum permissible temperature (Case wall)		70 °C (Including self temperature rising)	

*1 : The range of approval is different depending on each approval.

*2 : These are typical values.

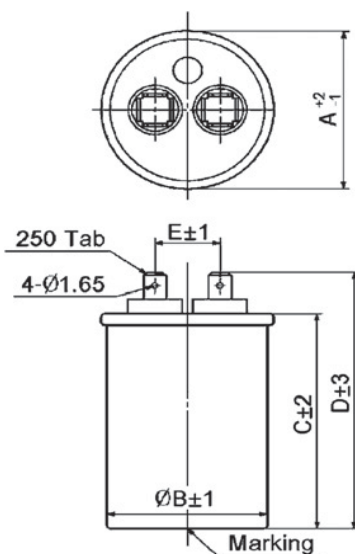
Dimension (Example)^{*3}

Unit : mm

*3 : Other shape and specific requirement can be designed. Please contact, if necessary.

Three tabs and as many as four tabs are also possible though standards of the number of terminal tabs are two tabs.

Rating · Dimensions^{*4}

Rated voltage (V) [AC]	Capacitance (μF)	Dimensions (mm)				
		A	B	C	D	E
370 to 440	5.0 to 10.0	43.0	41.0	70.0	83.0	16.0
	11.0 to 15.0	43.0	41.0	80.0	93.0	16.0
	16.0 to 20.0	43.0	41.0	90.0	103.0	16.0
	21.0 to 25.0	43.0	41.0	100.0	113.0	16.0
	26.0 to 30.0	43.0	41.0	110.0	123.0	16.0
	31.0 to 35.0	43.0	41.0	130.0	143.0	16.0
	36.0 to 40.0	48.0	45.0	110.0	123.0	18.0
	41.0 to 50.0	48.0	45.0	130.0	143.0	18.0
	51.0 to 55.0	53.0	50.5	110.0	123.0	18.0
	56.0 to 60.0	63.0	60.5	90.0	103.0	20.0
450	61.0 to 65.0	63.0	60.5	100.0	113.0	20.0
	5.0 to 10.0	43.0	41.0	70.0	83.0	16.0
	11.0 to 15.0	43.0	41.0	90.0	103.0	16.0
	16.0 to 20.0	43.0	41.0	110.0	123.0	16.0
	21.0 to 25.0	48.0	45.0	100.0	113.0	18.0
	26.0 to 30.0	48.0	45.0	110.0	123.0	18.0
	31.0 to 35.0	53.0	50.5	100.0	113.0	18.0
	36.0 to 40.0	53.0	50.5	110.0	123.0	18.0
	41.0 to 50.0	63.0	60.5	100.0	113.0	20.0
	51.0 to 55.0	63.0	60.5	110.0	123.0	20.0
56.0 to 60.0	63.0	60.5	130.0	143.0	20.0	

*4 : Please contact if necessary other Voltage and Capacitance.

Plastic Film Capacitors

Film Capacitor for AC Motor

PMF series



Features

- High safety (safety function installed)
- High reliability, safety standard approval
- Small size, lightness, and low loss
- RoHS compliant

Recommended applications

- Motor and small compressor (for running)

Construction

- Internal electrode : Metallized plastic film (safety function installed)
- Plastic case : UL94 V-0
- Sealing : UL94 V-0
- Terminal : Faston terminal (tin plating), Lead wire (tin plating), Insulated wire

Explanation of part number

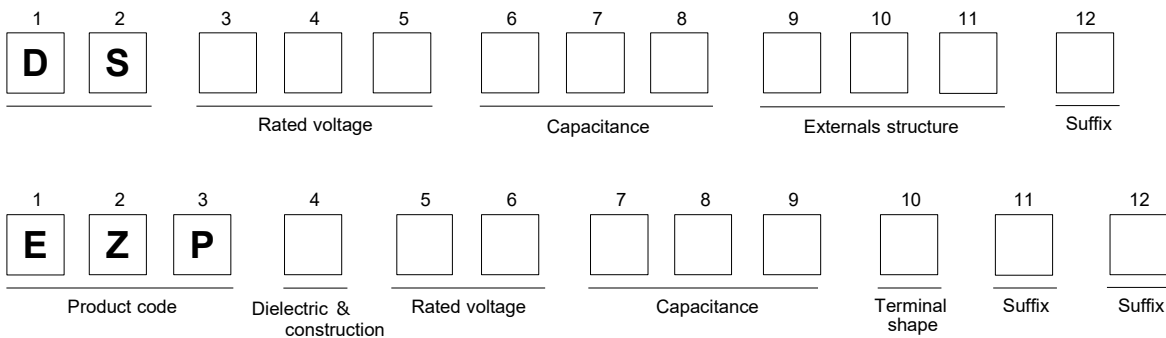

Applicable standard

Japan	JIS C 4908 Capacitors for electrical apparatus CMJ registration parts. Registration No.1475- C9902-026(JET)
UL/cUL	UL810/CSA C22.2 No.190 FILE No.E76560
CSA	CSA C22.2 No.190
Europe	EN60252-1 AC motor Capacitors TUV
China	GB/T 3667.1 AC motor Capacitors CQC

Specifications

Applicable standard ^{*1}		JIS UL	EN GB
Safety class		With built-in safety function P2 (CMJ approval) 10000 AFC (UL)	S3
Rated voltage (50/60 Hz) ^{*2} [AC]		150 V to 500 V (For UL Approved P/N : up to 480 V.AC)	EN / TUV : 450 V GB : 250 V, 450 V
Rated capacitance ^{*2}		0.5 μF to 65 μF	
Capacitance tolerance		-5 % / +10 %, ±5 % (Refer to the individual drawing)	
Withstand voltage	Between terminals	Rated voltage×1.75 60 s	Rated voltage×2.0 60 s
	Between terminals to enclosure	(min. 2000 V [AC]) Rated voltage × 2.0 + 1000 V [AC] 60 s	
Maximum permissible temperature (Case wall)		70 °C (Including self temperature rising)	

*1 : The range of approval is different depending on each approval.

*2 : These are typical values.

Dimension (Example)^{*3}

● Q series (Mounting type)

※ Non mounting type is available. (P series).

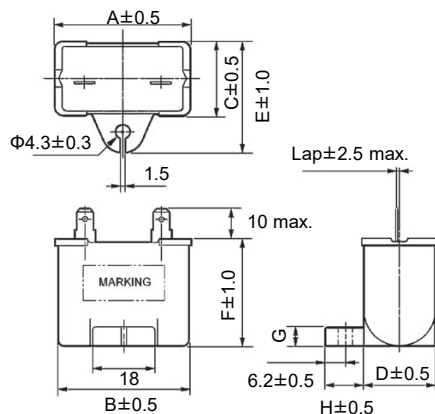

● T series (Printed circuit board (PCB))

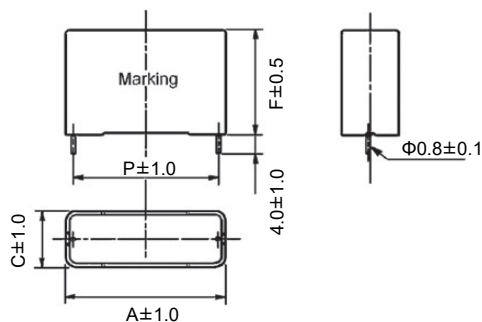

● Terminal shape (Standard)

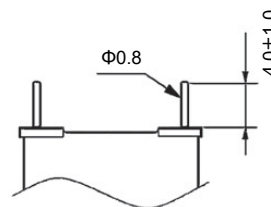
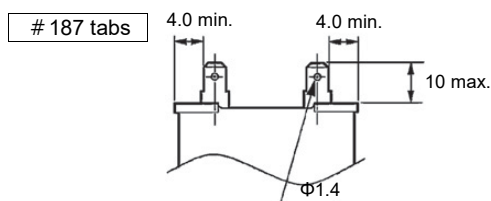

Unit : mm

*3 : Other shape and specific requirement can be designed. Please contact, if necessary.

Rating · Dimensions^{*4}

● Q series (Mounting type)

Rated voltage (V) [AC]	Capacitance (μF)	Dimensions (mm)								Case series
		A	B	C	D	E	F	G	H	
250	3.0 to 4.5	39.5	38.5	16.2	14.8	27.0	27.0	4.0	11.5	Q
	5.0 to 6.0	39.5	38.2	18.3	16.8	29.0	29.0			
	6.5 to 9.5	39.5	38.2	22.0	20.8	32.5	32.5			
	10.0 to 16.0	49.7	48.3	24.0	22.5	34.5	34.5			
	16.5 to 20.0	50.0	48.5	26.7	25.3	37.5	38.0			
	20.5 to 25.0	50.0	48.5	30.5	28.8	41.0	41.5			
25.5 to 34.5	50.0	48.5	34.0	32.6	45.0	45.0	6.0	11.5		
450	1.0 to 1.4	39.5	38.5	16.2	14.8	27.0	27.0		4.0	
	1.5 to 1.8	39.5	38.2	18.3	16.8	29.0	29.0			
	1.9 to 2.5	39.5	38.2	22.0	20.8	32.5	32.5			
	3.0 to 5.0	49.7	48.3	24.0	22.5	34.5	34.5			
	5.5 to 6.5	50.0	48.5	26.7	25.3	37.5	38.0			
	7.0 to 8.0	50.0	48.5	30.5	28.8	41.0	41.5			
8.5 to 10.5	50.0	48.5	34.0	32.6	45.0	45.0	6.0			

● T series (Printed circuit board (PCB))

Rated voltage (V) [AC]	Capacitance (μF)	Dimensions (mm)				Case series
		A	C	F	P	
250	3.0 to 4.0	38.5	14.0	25.5	36.0	T
	4.5 to 6.5	38.5	15.5	29.0	36.0	
	7.0 to 8.0	38.5	20.5	29.0	36.0	
	8.5 to 11.0	38.5	25.0	34.0	36.0	
	11.5 to 18.5	48.5	22.0	36.0	46.0	
450	1.0 to 1.3	38.5	14.0	25.5	36.0	
	1.4 to 2.0	38.5	15.5	29.0	36.0	
	2.1 to 2.5	38.5	20.5	29.0	36.0	
	3.0 to 3.5	38.5	25.0	34.0	36.0	
	4.0 to 5.5	48.5	22.0	36.0	46.0	

*4 : Please contact if necessary other Voltage and Capacitance.



Plastic Film Capacitors

Film Capacitor for AC Motor

SMF series

Features

- High safety (safety function installed)
- High reliability, safety standard approval
- Small size, lightness, and low loss
- RoHS compliant

Recommended applications

- Motor and small compressor (for running)

Construction

- Internal electrode : Metallized plastic film (safety function installed)
- Plastic case : UL94 V-0
- Sealing : UL94 V-0
- Terminal : Faston terminal (tin plating), Lead wire (tin plating), Insulated wire

Explanation of part number

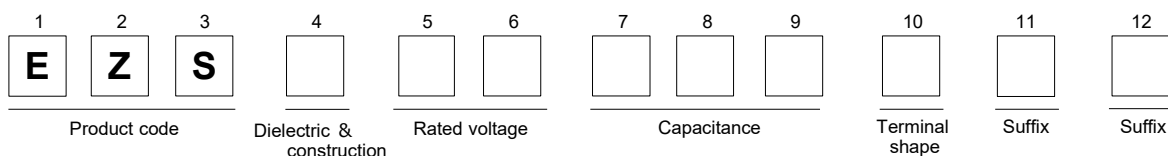
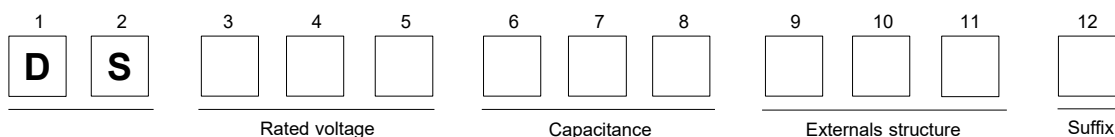

Applicable standard

Japan	JIS C 4908 Capacitors for electrical apparatus CMJ registration parts. Registration No.1475- C9902-026(JET)
UL/cUL	UL810 FILE No.E76560
Europe	EN60252-1 AC motor Capacitors VDE
China	GB/T 3667.1 AC motor Capacitors CQC

Specifications

Applicable standard ^{*1}		JIS UL	EN GB
Safety class		With built-in safety function P2 (CMJ approval) 10000 AFC (UL)	S0
Rated voltage (50/60 Hz) ^{*2} [AC]		370 V to 450 V	400 V, 450 V
Rated capacitance ^{*2}		1.5 μF to 9 μF	
Capacitance tolerance		-5 % / +10 %, ±5 % (Refer to the individual drawing)	
Withstand voltage	Between terminals	Rated voltage×1.75 60 s	Rated voltage×2.0 60 s
	Between terminals to enclosure	(min. 2000 V [AC]) Rated voltage × 2.0 + 1000 V [AC] 60 s	
Maximum permissible temperature (Case wall)		70 °C (Including self temperature rising)	

*1 : The range of approval is different depending on each approval.

*2 : These are typical values.

Dimension (Example)^{*3}

● SQ series (Installation leg type)

※ Non mounting type is available. (SP series).

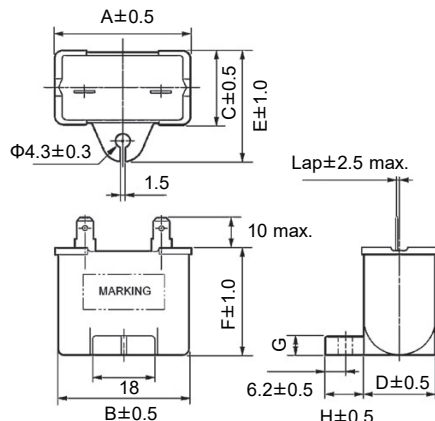

● T series (Printed circuit board (PCB))

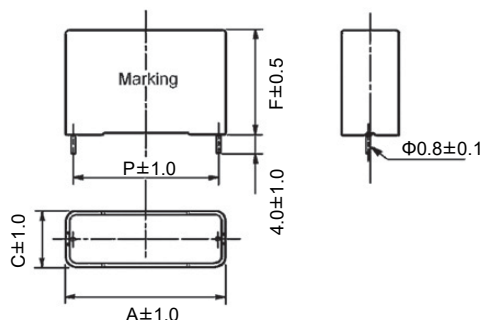

● Terminal shape (Standard)

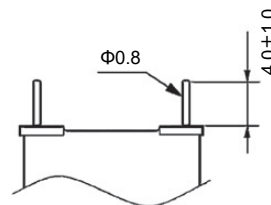
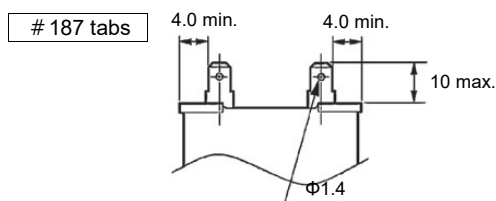

Unit : mm

*3 : Other shape and specific requirement can be designed. Please contact, if necessary.

Rating · Dimensions^{*4}

● SQ series (Installation leg type)

Rated voltage (V) [AC]	Capacitance (μF)	Dimensions (mm)								Case series
		A	B	C	D	E	F	G	H	
400	1.5 to 3.0	39.5	38.0	16.0	14.5	26.5	30.5	4.0	11.0	SQ
	3.5	39.5	38.0	17.5	16.0	28.0	30.5			
	4.0 to 5.0	39.5	38.0	22.0	20.5	32.5	30.5			
	5.5 to 6.5	39.5	38.0	26.7	25.2	37.0	32.0			
	7.0 to 8.0	39.5	38.0	26.7	25.2	37.0	37.0			
450	8.5 to 9.0	39.5	38.0	26.7	25.2	37.0	41.0	4.0	11.0	
	1.5 to 2.5	39.5	38.0	16.0	14.5	26.5	30.5			
	3.0	39.5	38.0	17.5	16.0	28.0	30.5			
	3.5 to 4.0	39.5	38.0	22.0	20.5	32.5	30.5			
	4.5 to 5.5	39.5	38.0	26.7	25.2	37.0	32.0			
450	6.0 to 6.5	39.5	38.0	26.7	25.2	37.0	37.0	4.0	11.0	
	7.0 to 7.5	39.5	38.0	26.7	25.2	37.0	41.0			

● T series (Printed circuit board (PCB))

Rated voltage (V) [AC]	Capacitance (μF)	Dimensions (mm)				Case series
		A	C	F	P	
400	1.5 to 2.5	38.5	14.0	25.5	36.0	T
	3.0 to 3.5	38.5	15.5	29.0	36.0	
	4.0 to 5.0	38.5	20.5	29.0	36.0	
	5.5 to 7.5	38.5	25.0	34.0	36.0	
450	1.5 to 2.0	38.5	14.0	25.5	36.0	
	2.5 to 3.0	38.5	15.5	29.0	36.0	
	3.5 to 4.0	38.5	20.5	29.0	36.0	
	4.5 to 6.5	38.5	25.0	34.0	36.0	

*4 : Please contact if necessary other Voltage and Capacitance.

Plastic Film Capacitors

Metalized Polyester Film Capacitor
for Noise suppression of Automobile

ECQE series

Non-inductive construction using metallized polyester film with flame retardant epoxy resin.

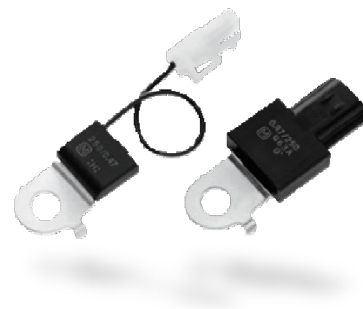

Features

- Excellent water-proof and corrosion-proof construction properties.
- Guaranteed operation temperature of 130 °C max.
- Available with wide variety of terminals, including blacket and lead wire.
- RoHS compliant

Recommended applications

- Noise suppression for automobile

Explanation of part number

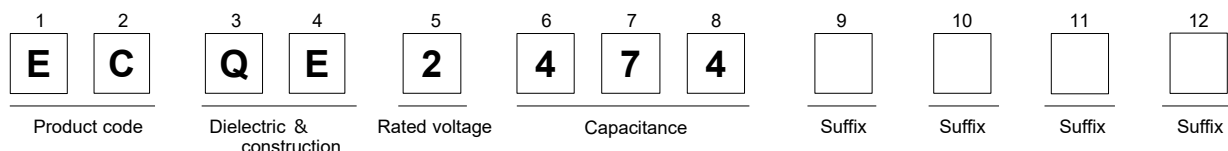

Specifications

Category temperature range (Including temperature-rise on unit surface)	-40 °C to +130 °C (Except cord, connector, tube and tape)
Rated voltage* [DC]	250 V (Derating of rated voltage by 1.11 %/°C at more than 85 °C)
Rated capacitance*	0.47 μF, 2.2 μF, 4.7 μF
Capacitance tolerance	±20 % (M)
Dissipation factor (tan δ)	tan δ ≤ 1.0 % (20 °C, 1 kHz)
Withstand voltage	250 V × 150 %, 60 s
Insulation resistance (IR)	IR ≥ 3000 MΩ · μF (20 °C, 100 V [DC], 60 s)

Dimensions (Example)

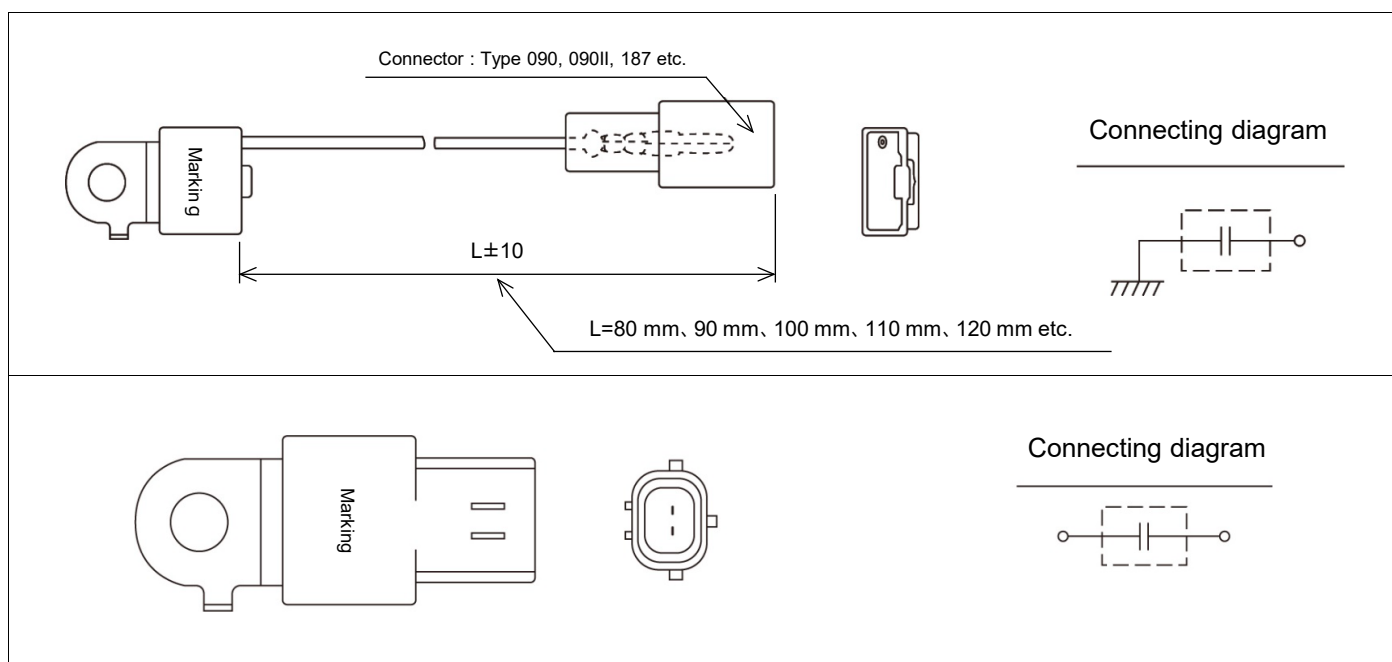

* Other voltage ratings, capacitance values and special dimensions are available upon request.
Please consult engineering section.



Plastic Film Capacitors

Metallized Polypropylene Film Capacitor (For Automotive)

ECWFG series

Non-inductive construction using metallized polypropylene film with flame retardant plastic case.

Features

- High safety (with safety function)
- High moisture resistance (85°C, 85%)
 - 600 V : 420 V, 500 h
 - 630 V : 500 V, 1000 h
 - 700 V : 500 V, 1000 h
 - 800 V : 560 V, 500 h
 - 1100 V : 700 V, 500 h (C < 2.0 μF) / 770 V, 500 h (C ≥ 2.0 μF)
- High thermal shock resistance (600 to 1100 V : -55°C ⇔ 85°C, 1000 cycles)
- High temperature load test (125°C)
 - 600 V : 360 V, 1000 h
 - 630 V : 450 V, 1000 h
 - 700 V : 450 V, 1000 h
 - 800 V : 480 V, 1000 h
 - 1100 V : 660 V, 1000 h
- Flame-retardant plastic case and non-combustible resin
- AEC-Q200 compliant
- RoHS compliant

Recommended applications

- DC/DC, AC/DC converter circuit in xEV
- High frequency and high current circuits

Explanation of part number

■ Lead pitch : 22.5 mm

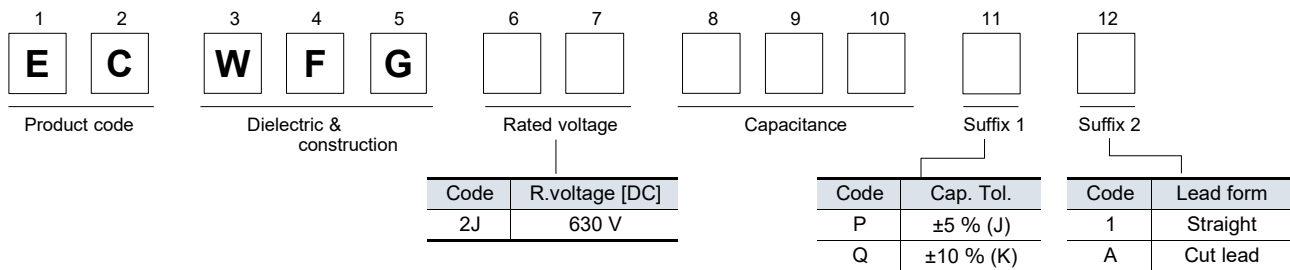

■ Lead pitch : 27.5 mm

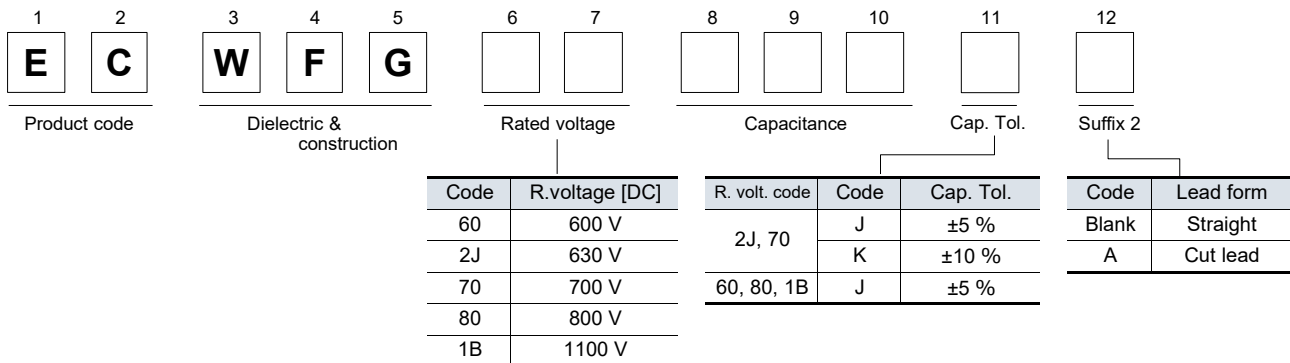

Specifications

Category temp. range (Including temperature-rise on unit surface)	-40 °C to +110 °C		
Rated voltage [DC]	600 V to 1100 V (Derating of rated voltage by 1.0 % / °C at more than 85 °C)		
Capacitance range	600 V	Lead pitch : 27.5 mm	2.0 μF to 12.0 μF
	630 V	Lead pitch : 22.5 mm	1.0 μF to 3.0 μF
		Lead pitch : 27.5 mm	1.0 μF to 4.7 μF
	700 V	Lead pitch : 27.5 mm	1.0 μF to 4.7 μF
	800 V	Lead pitch : 27.5 mm	2.0 μF to 8.0 μF
1100 V	Lead pitch : 27.5 mm	1.0 μF to 5.0 μF	
Capacitance tolerance	±5% (J), ±10 % (K)		
Dissipation factor (tan δ)	tan δ ≤ 0.1 % (20 °C, 1 kHz)		
Withstand voltage	Between terminals : Rated voltage (V) × 150 % 60 s		
Insulation resistance (IR)	IR ≥ 3,000 MΩ·uF (20 °C, 500 V [DC], 60 s)		

* In case of applying voltage in alternating current (50 Hz or 60 Hz sine wave) to a capacitor with DC rated voltage, please refer to the page of "Permissible voltage (R.M.S) in alternating current corresponding to DC rated voltage".

Dimensions

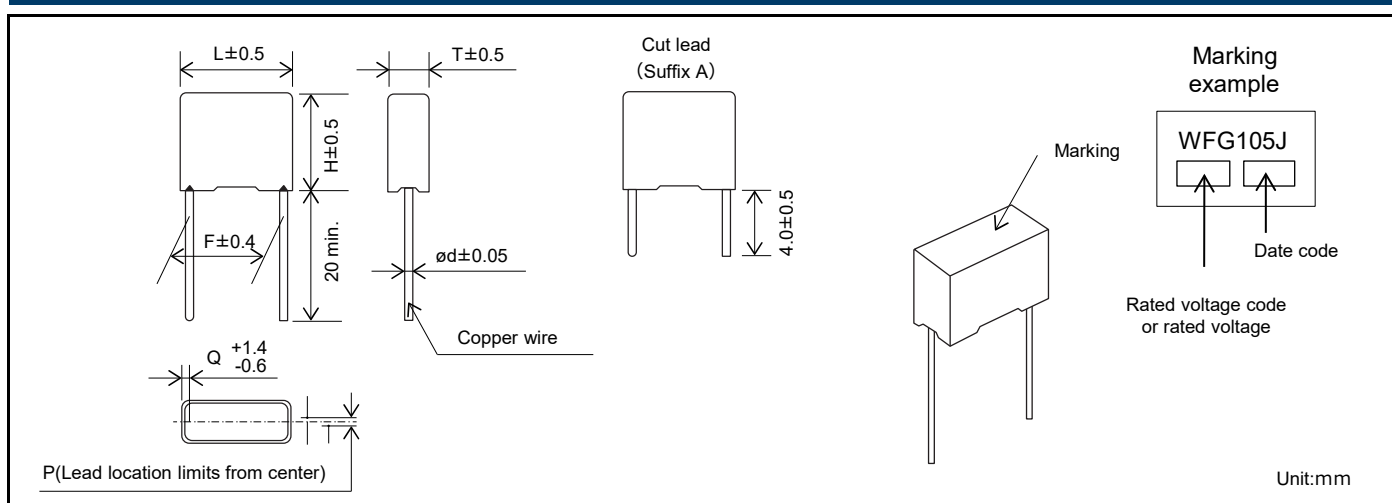

Rating · Dimensions · Quantity

■ Rated voltage [DC] : 600 V, Capacitance tolerance : ±5 % (J)

Part No	Cap. (μF)	Dimensions (mm)							Min. order Q'ty (PCS)	
		L	T	H	F	ød	P	Q	Straight	Cut lead
ECWFG60205J()	2.0	31.5	8.0	17.0	27.5	0.8	0±1.0	2.0	400	400
ECWFG60225J()	2.2	31.5	8.0	17.0	27.5	0.8	0±1.0	2.0	400	400
ECWFG60275J()	2.7	31.5	9.5	18.0	27.5	0.8	0±1.0	2.0	400	350
ECWFG60305J()	3.0	31.5	9.5	18.0	27.5	0.8	0±1.0	2.0	400	350
ECWFG60335J()	3.3	31.5	9.5	18.0	27.5	0.8	0±1.0	2.0	400	350
ECWFG60355J()	3.5	31.5	9.5	18.0	27.5	0.8	0±1.0	2.0	400	350
ECWFG60395J()	3.9	31.5	10.5	21.0	27.5	0.8	0±1.0	2.0	300	300
ECWFG60405J()	4.0	31.5	10.5	21.0	27.5	0.8	0±1.0	2.0	300	300
ECWFG60475J()	4.7	31.5	12.0	24.5	27.5	0.8	0±1.0	2.0	200	250
ECWFG60505J()	5.0	31.5	12.0	24.5	27.5	0.8	0±1.0	2.0	200	250
ECWFG60565J()	5.6	31.5	12.0	24.5	27.5	0.8	0±1.0	2.0	200	250
ECWFG60605J()	6.0	31.5	12.0	24.5	27.5	0.8	0±1.0	2.0	200	250
ECWFG60685J()	6.8	31.5	12.0	24.5	27.5	0.8	0±1.0	2.0	200	250
ECWFG60705J()	7.0	31.5	13.5	28.5	27.5	0.8	0±1.0	2.0	150	150
ECWFG60755J()	7.5	31.5	13.5	28.5	27.5	0.8	0±1.0	2.0	150	150
ECWFG60805J()	8.0	31.5	13.5	28.5	27.5	0.8	0±1.0	2.0	150	150
ECWFG60825J()	8.2	31.5	13.5	28.5	27.5	0.8	0±1.0	2.0	150	150
ECWFG60905J()	9.0	31.5	13.5	28.5	27.5	0.8	0±1.0	2.0	150	150
ECWFG60106J()	10.0	31.5	13.5	28.5	27.5	0.8	0±1.0	2.0	150	150
ECWFG60126J()	12.0	31.5	17.5	32.5	27.5	0.8	0±1.0	2.0	150	100

* () : Suffix for lead crimped

Rating · Dimensions · Quantity

■ Rated voltage [DC] : 630 V, Capacitance tolerance : ±5 %(J), ±10 %(K)
 [Lead pitch : 22.5 mm]

Part No	Cap. (μF)	Dimensions (mm)							Min. order Q'ty (PCS)	
		L	T	H	F	ød	P	Q	Straight	Cut lead
		ECWFG2J105P()	1.0	27.0	10.5	19.0	22.5	1.0		
ECWFG2J105Q()										
ECWFG2J155P()	1.5	27.0	12.0	21.0	22.5	1.0	0±0.8	2.25	300	300
ECWFG2J155Q()										
ECWFG2J225P()	2.2	27.0	15.5	24.0	22.5	1.0	0±0.8	2.25	200	250
ECWFG2J225Q()										
ECWFG2J305P()	3.0	27.0	17.5	26.5	22.5	1.0	0±0.8	2.25	150	150
ECWFG2J305Q()										

* () : Suffix for lead crimped

[Lead pitch : 27.5 mm]

Part No	Cap. (μF)	Dimensions (mm)							Min. order Q'ty (PCS)	
		L	T	H	F	ød	P	Q	Straight	Cut lead
		ECWFG2J105□()	1.0	31.5	9.5	18.0	27.5	1.0		
ECWFG2J155□()										
ECWFG2J225□()	2.2	31.5	12.0	24.5	27.5	1.0	0±0.8	2.0	200	250
ECWFG2J305□()										
ECWFG2J475□()	4.7	31.5	17.5	32.5	27.5	1.0	0±0.8	2.0	100	100

* □ : Capacitance tolerance code

* () : Suffix for lead crimped

■ Rated voltage [DC] : 700 V, Capacitance tolerance : ±5 %(J), ±10 %(K)

Part No	Cap. (μF)	Dimensions (mm)							Min. order Q'ty (PCS)	
		L	T	H	F	ød	P	Q	Straight	Cut lead
		ECWFG70105□()	1.0	31.5	9.5	18.0	27.5	1.0		
ECWFG70155□()										
ECWFG70205□()	2.0	31.5	12.0	24.5	27.5	1.0	0±0.8	2.0	200	250
ECWFG70225□()										
ECWFG70305□()	3.0	31.5	13.5	28.5	27.5	1.0	0±0.8	2.0	150	150
ECWFG70395□()										
ECWFG70475□()	4.7	31.5	17.5	32.5	27.5	1.0	0±0.8	2.0	100	100

* □ : Capacitance tolerance code

* () : Suffix for lead crimped

■ Rated voltage [DC] : 800 V, Capacitance tolerance : ±5 %(J)

Part No	Cap. (μF)	Dimensions (mm)							Min. order Q'ty (PCS)	
		L	T	H	F	ød	P	Q	Straight	Cut lead
		ECWFG80205J()	2.0	31.5	10.5	21.0	27.5	0.8		
ECWFG80225J()										
ECWFG80275J()	2.7	31.5	12.0	24.5	27.5	0.8	0±1.0	2.0	200	250
ECWFG80305J()										
ECWFG80335J()	3.3	31.5	12.0	24.5	27.5	0.8	0±1.0	2.0	200	250
ECWFG80355J()										
ECWFG80395J()	3.9	31.5	13.5	28.5	27.5	0.8	0±1.0	2.0	150	150
ECWFG80405J()										
ECWFG80475J()	4.7	31.5	13.5	28.5	27.5	0.8	0±1.0	2.0	150	150
ECWFG80505J()										
ECWFG80565J()	5.6	31.5	16.0	29.5	27.5	0.8	0±1.0	2.0	150	100
ECWFG80605J()										
ECWFG80685J()	6.8	31.5	16.0	29.5	27.5	0.8	0±1.0	2.0	150	100
ECWFG80705J()										
ECWFG80755J()	7.5	31.5	17.5	32.5	27.5	0.8	0±1.0	2.0	150	100
ECWFG80805J()										

* () : Suffix for lead crimped

Rating · Dimensions · Quantity

■ Rated voltage [DC] : 1100 V, Capacitance tolerance : ±5 %(J)

Part No	Cap. (μ F)	Dimensions (mm)							Min. order Q'ty (PCS)	
		L	T	H	F	ϕ d	P	Q	Straight	Cut lead
ECWFG1B105J()	1.0	31.5	10.5	21.0	27.5	0.8	0±1.0	2.0	300	300
ECWFG1B155J()	1.5	31.5	12.0	24.5	27.5	0.8	0±1.0	2.0	200	250
ECWFG1B205J()	2.0	31.5	12.0	24.5	27.5	0.8	0±1.0	2.0		
ECWFG1B225J()	2.2	31.5	13.5	28.5	27.5	0.8	0±1.0	2.0	150	150
ECWFG1B305J()	3.0	31.5	16.0	29.5	27.5	0.8	0±1.0	2.0		
ECWFG1B335J()	3.3	31.5	16.0	29.5	27.5	0.8	0±1.0	2.0		
ECWFG1B405J()	4.0	31.5	17.5	32.5	27.5	0.8	0±1.0	2.0	100	100
ECWFG1B475J()	4.7	31.5	18.5	35.0	27.5	0.8	0±1.0	2.0		
ECWFG1B505J()	5.0	31.5	18.5	35.0	27.5	0.8	0±1.0	2.0		

* () : Suffix for lead crimped

Characteristics data

■ **Rated voltage [DC] : 600 V**

Electrical characteristics <Typical data >

Temperature characteristics

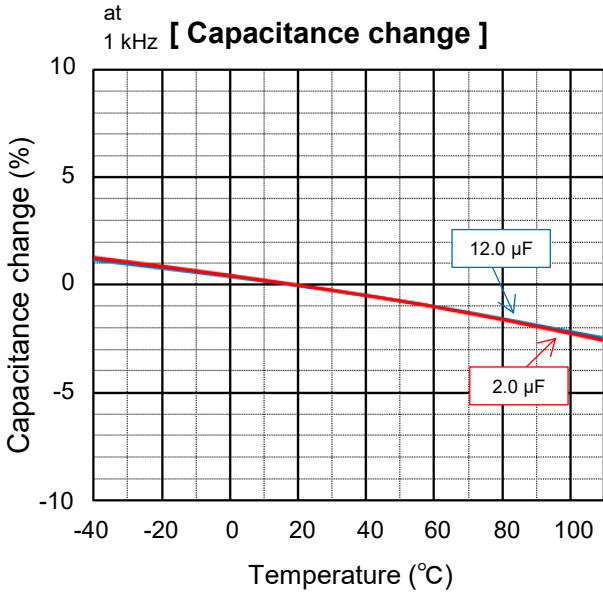

Frequency characteristics

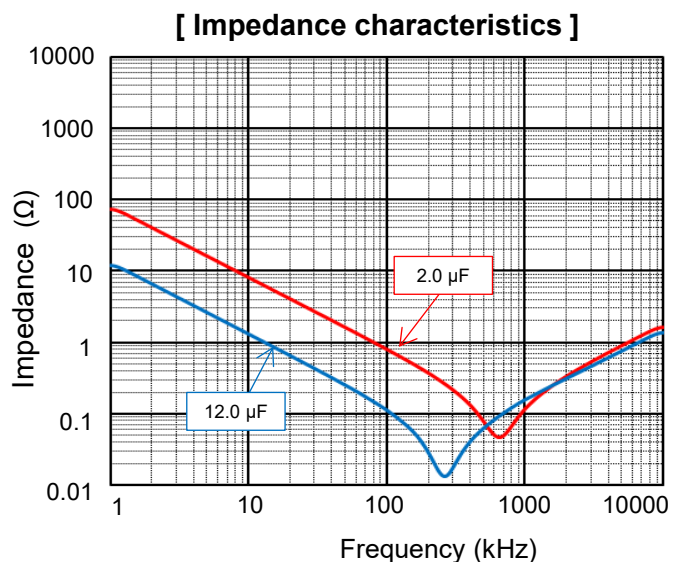
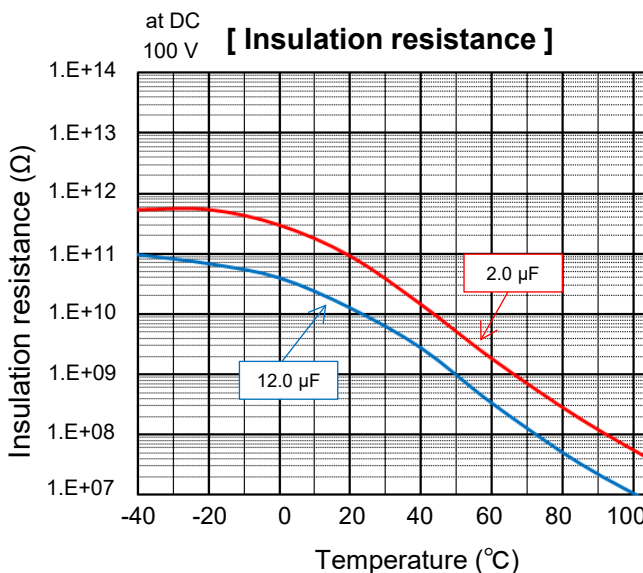
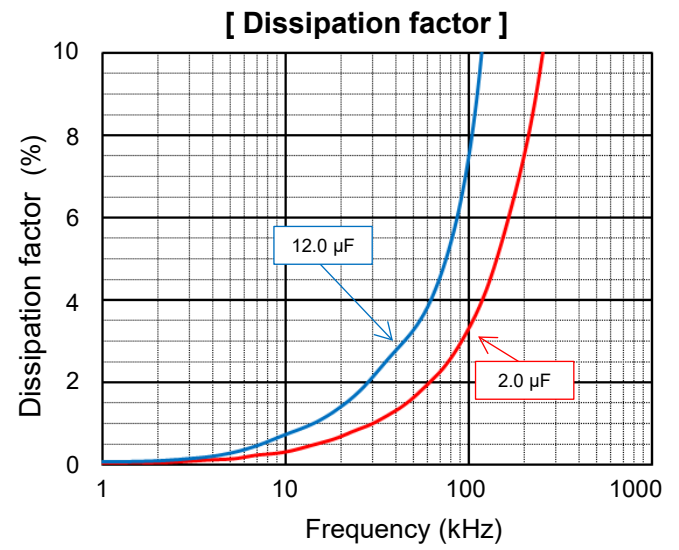
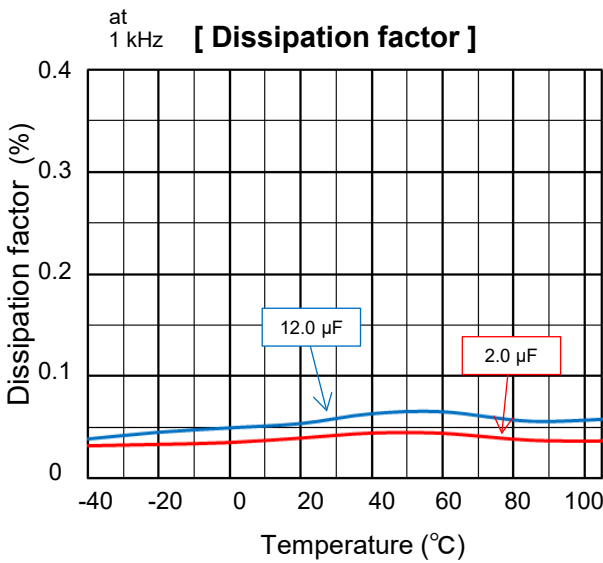
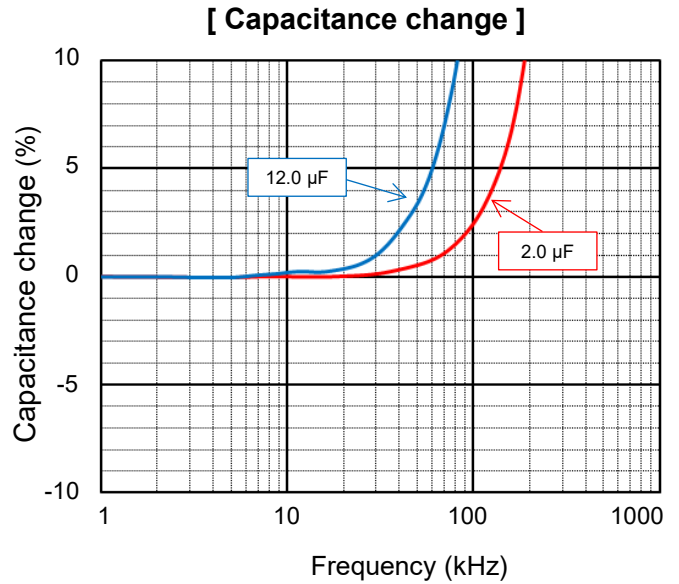

Characteristics data

■ **Rated voltage [DC] : 600 V**

Applicable specifications

[Permissible Current]

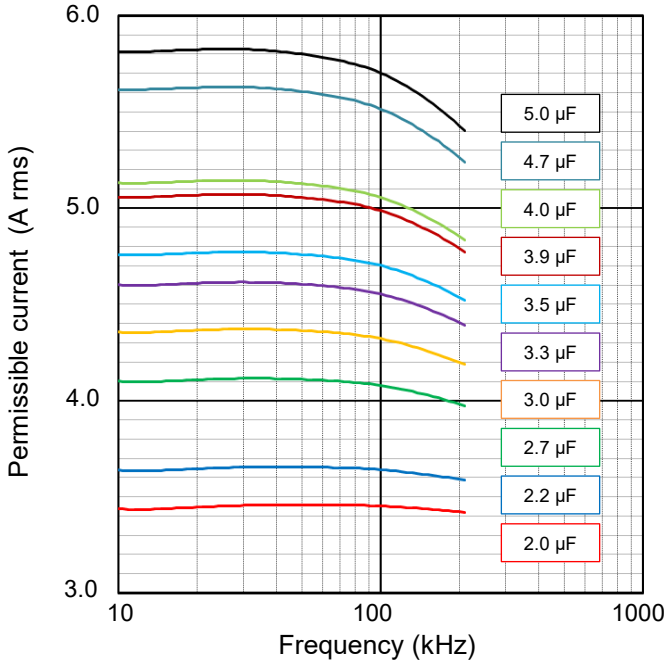

[Permissible Current Derating by Temperature]

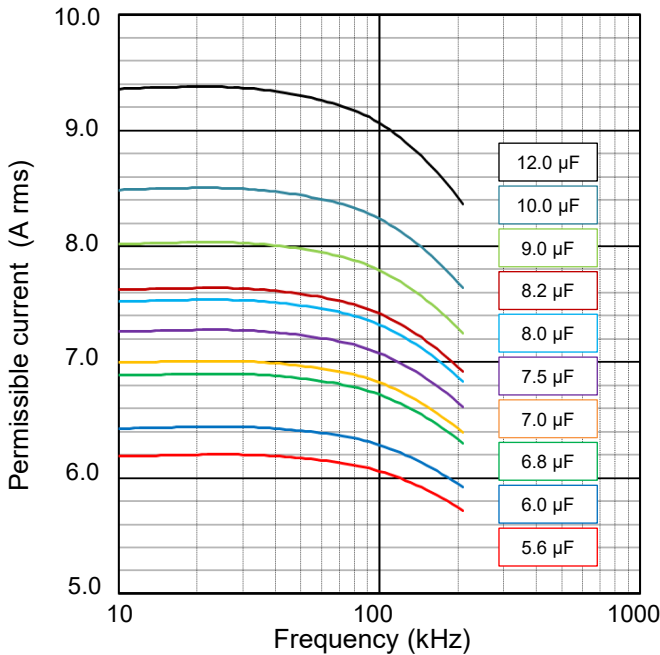
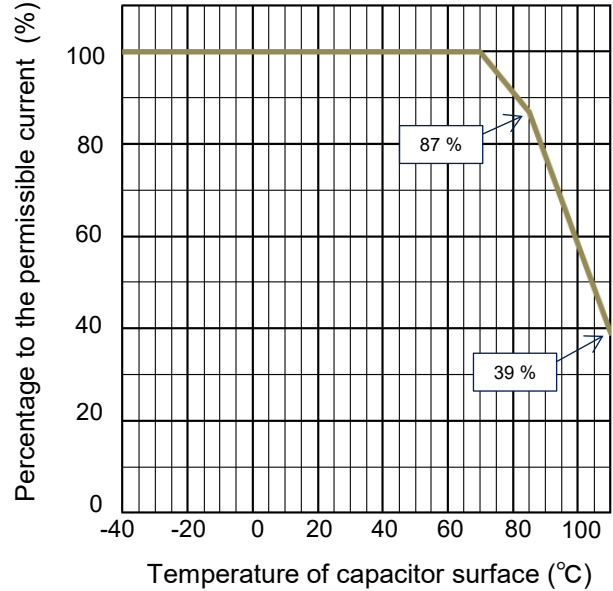

[Voltage Derating by Temperature]

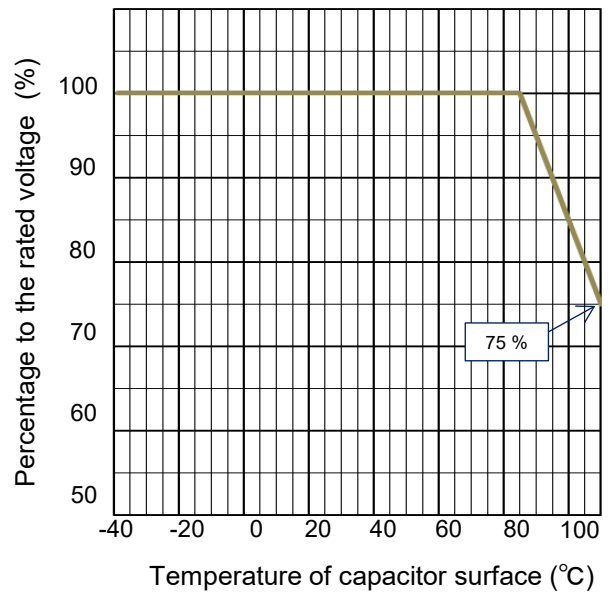

Permissible pulse current (dV/dt) (Max. 10000 cycles)

R. voltage [DC] (V)	Capacitance (μF)	Code	dV/dt (V/μs)	Current (Ao-p)
600	2.0	205	40	80
	2.2	225		88
	2.7	275		108
	3.0	305		120
	3.3	335		132
	3.5	355		140
	3.9	395		156
	4.0	405		160
	4.7	475		188
	5.0	505		200

R. voltage [DC] (V)	Capacitance (μF)	Code	dV/dt (V/μs)	Current (Ao-p)
600	5.6	565	40	224
	6.0	605		240
	6.8	685		272
	7.0	705		280
	7.5	755		300
	8.0	805		320
	8.2	825		328
	9.0	905		360
	10.0	106		400
	12.0	126		480

Design and specifications are each subject to change without notice. Ask factory for the current technical specifications before purchase and/or use. Should a safety concern arise regarding this product, please be sure to contact us immediately.

Characteristics data

■ **Rated voltage [DC] : 630 V**

Electrical characteristics <Typical data >

Temperature characteristics

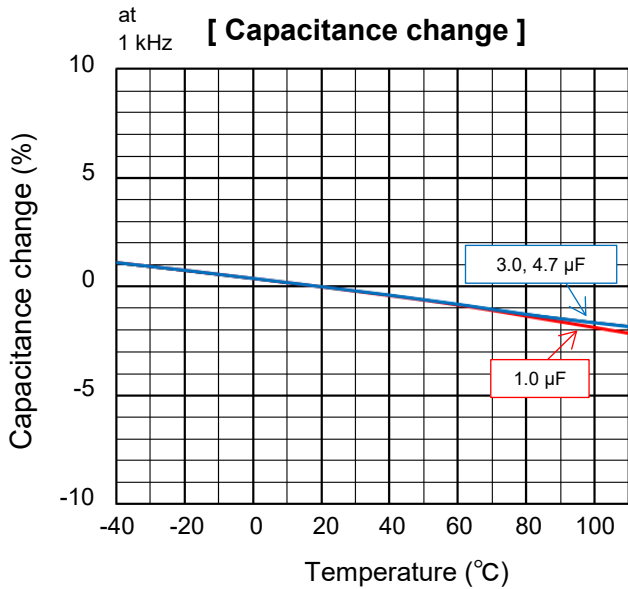

Frequency characteristics

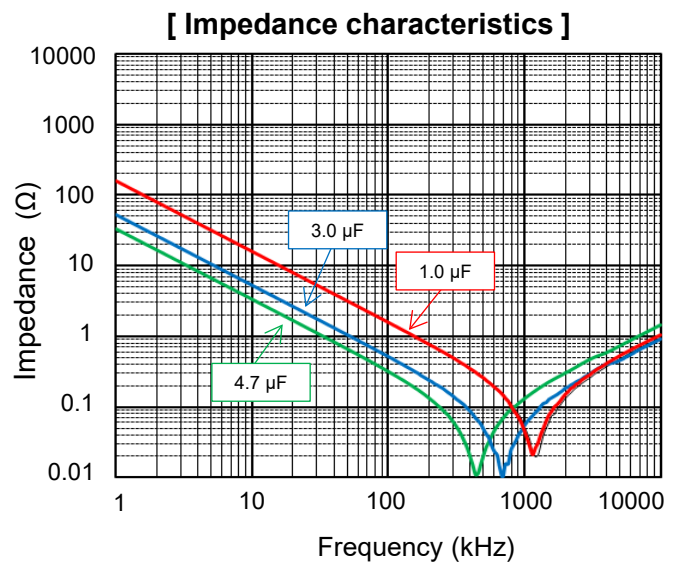
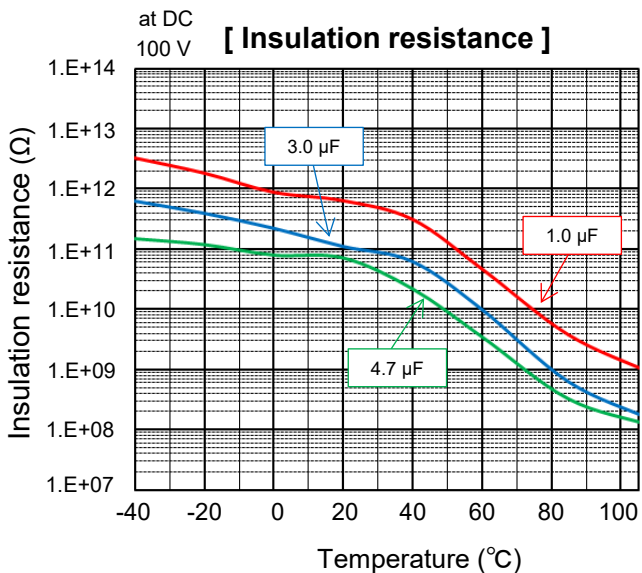
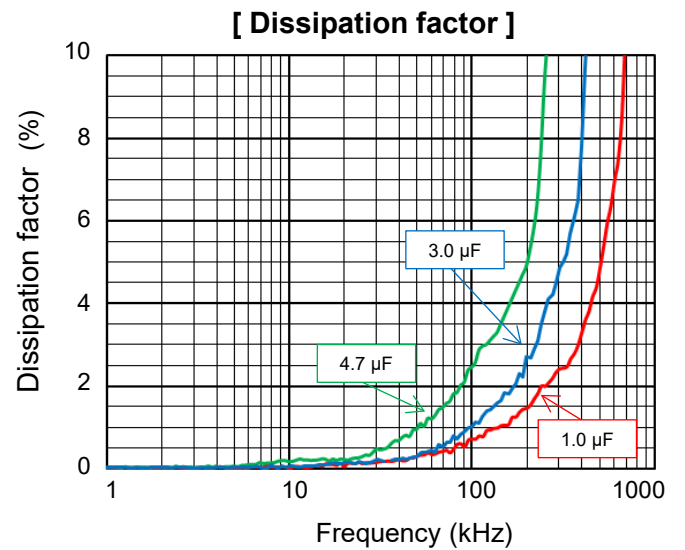
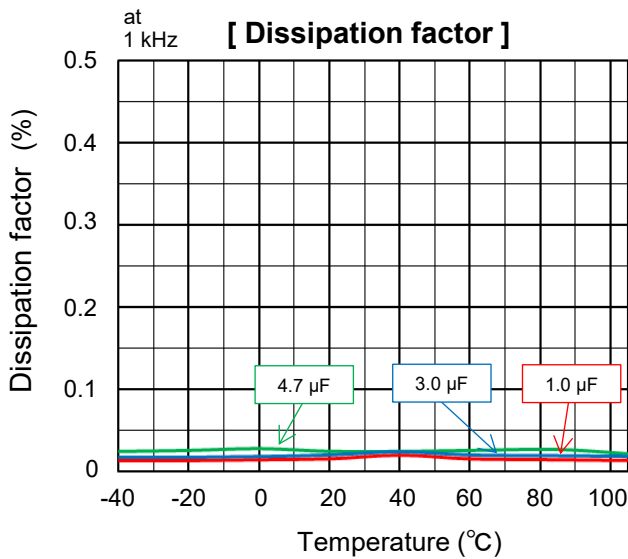
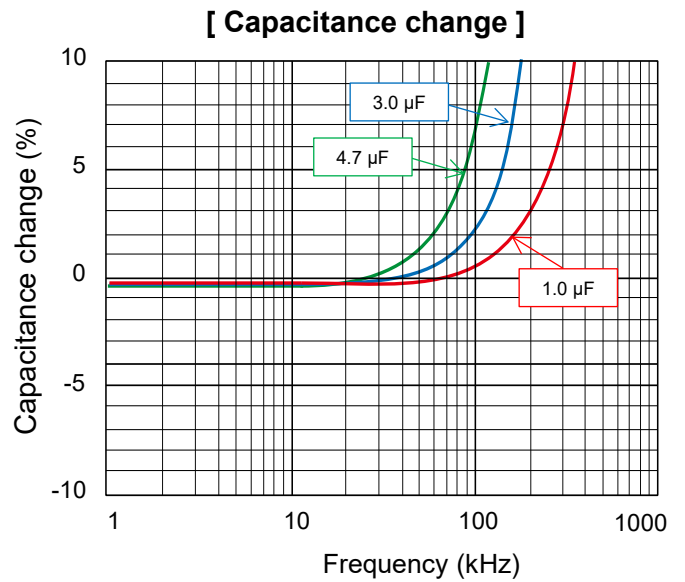

Characteristics data

■ **Rated voltage [DC] : 630 V**

Applicable specifications

[Permissible Current]

Lead pitch 22.5 mm

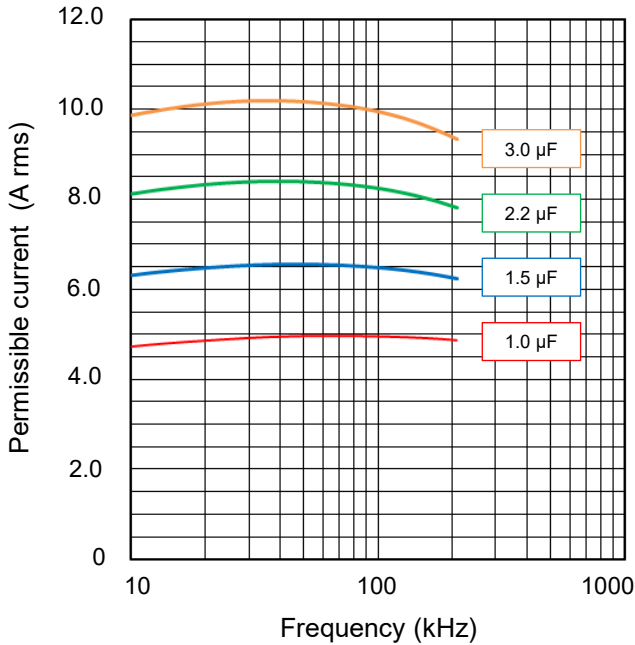

[Permissible Current Derating by Temperature]

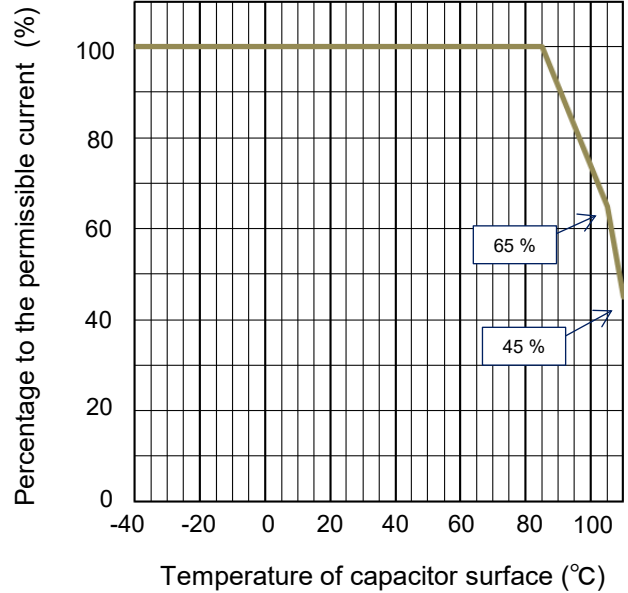

[Permissible Current]

Lead pitch 27.5 mm

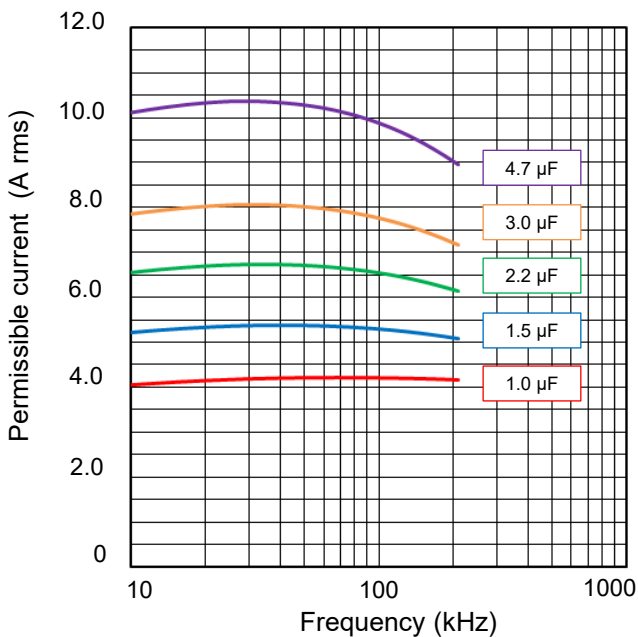

[Voltage Derating by Temperature]

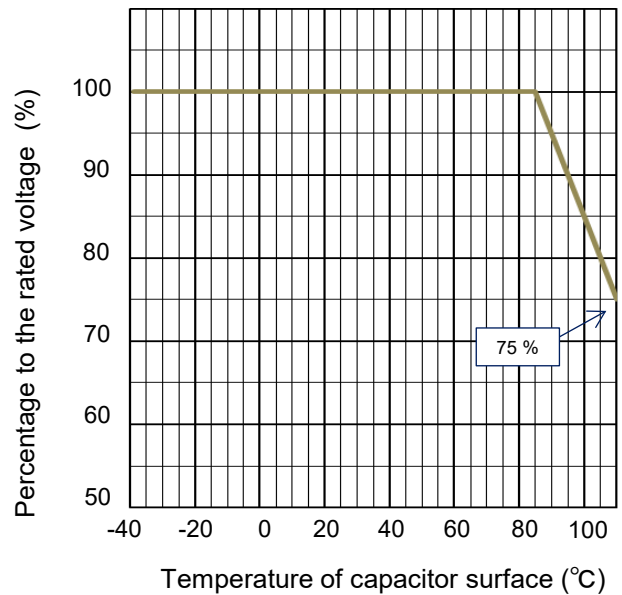

Permissible pulse current (dV/dt)
(Max. 10000 cycles)

R. voltage [DC] (V)	Pitch (mm)	Capacitance (μF)	Code	dV/dt (V/μs)	Current (Ao-p)
630	22.5	1.0	105	65	65.0
		1.5	155		97.5
		2.2	225		143.0
		3.0	305		195.0
	27.5	1.0	105	50	50.0
		1.5	155		75.0
		2.2	225		110.0
		3.0	305		150.0
		4.7	475		235.0

Design and specifications are each subject to change without notice. Ask factory for the current technical specifications before purchase and/or use. Should a safety concern arise regarding this product, please be sure to contact us immediately.

Characteristics data

■ **Rated voltage [DC] : 700 V**

Electrical characteristics <Typical data >

Temperature characteristics

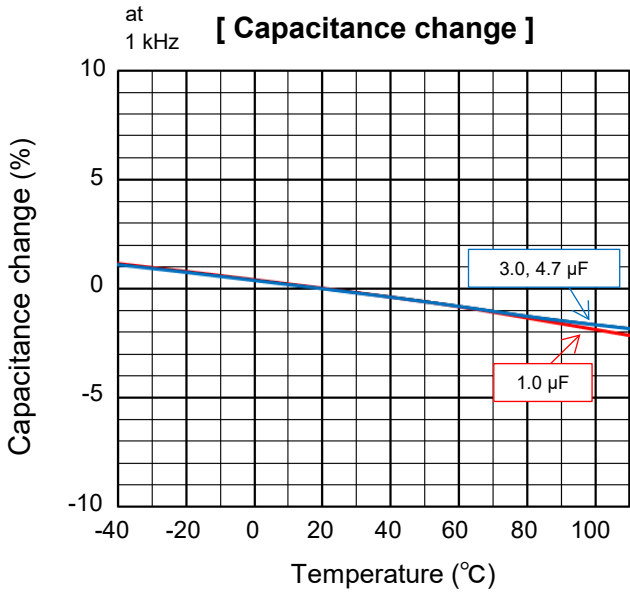

Frequency characteristics

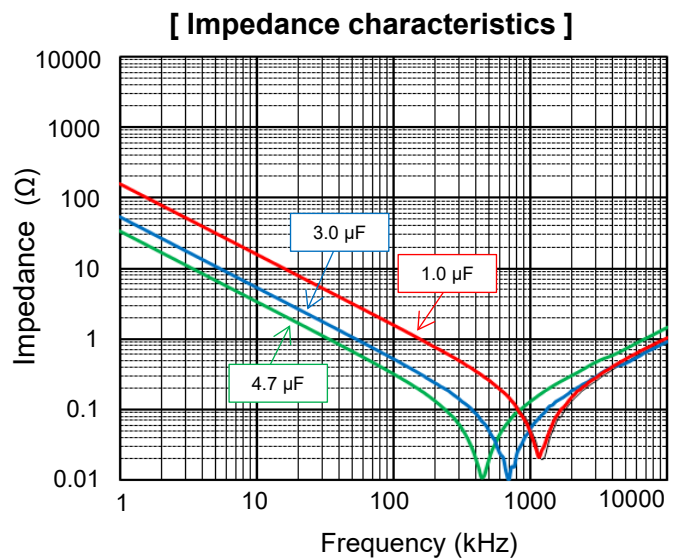
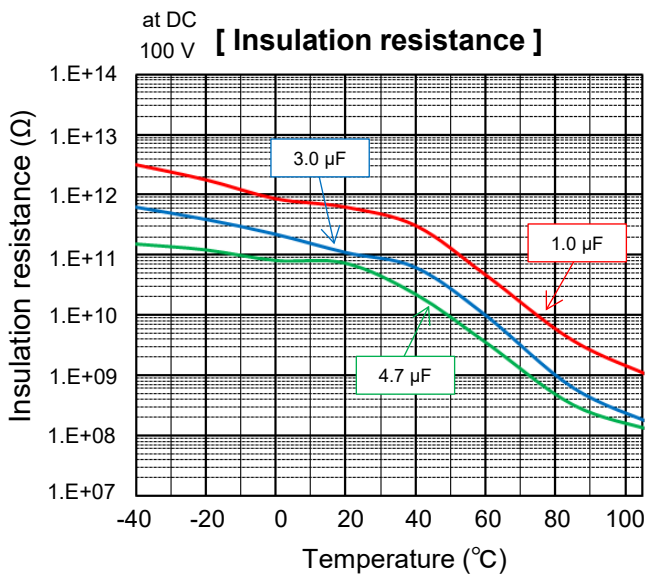
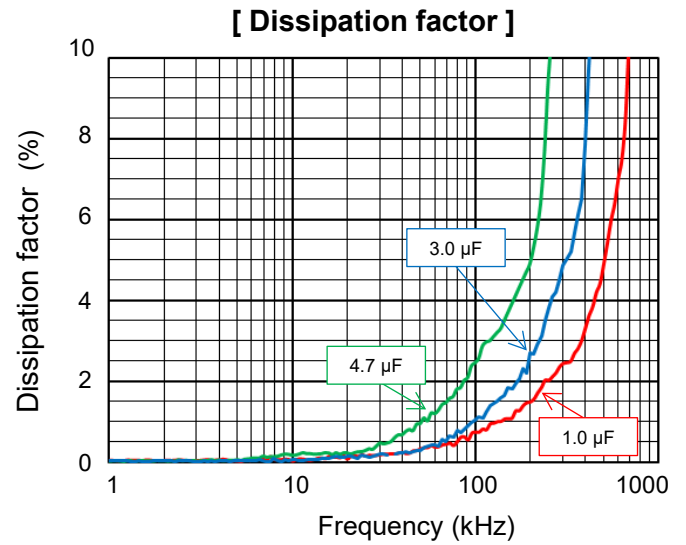
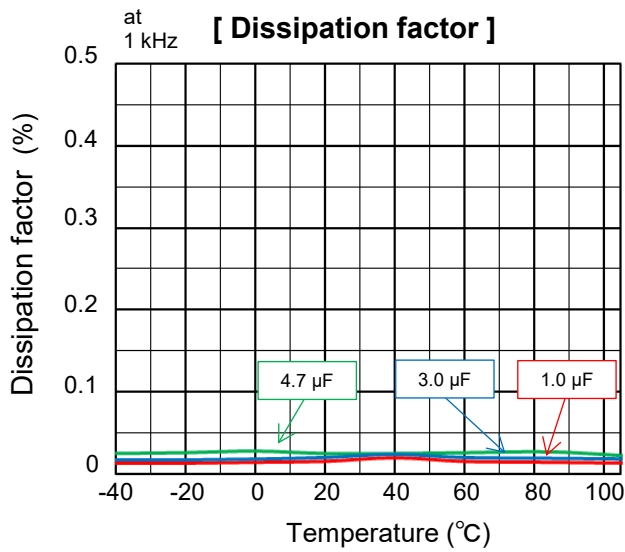
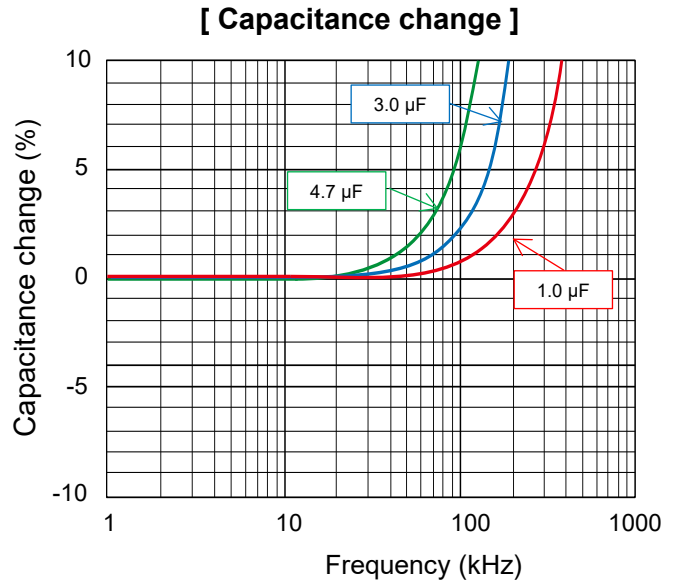

Characteristics data

■ **Rated voltage [DC] : 700 V**

Applicable specifications

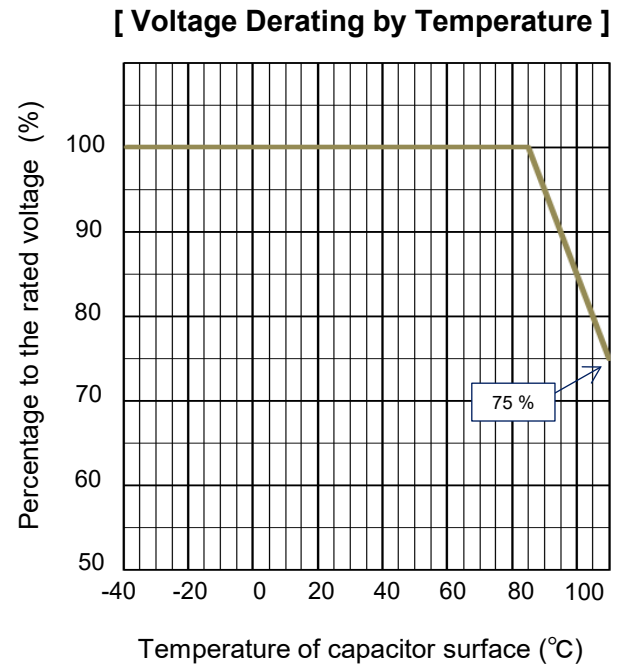
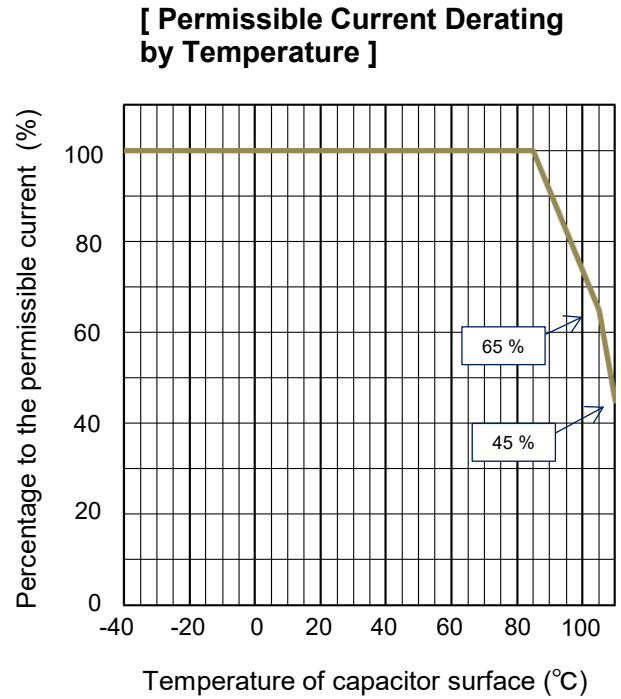
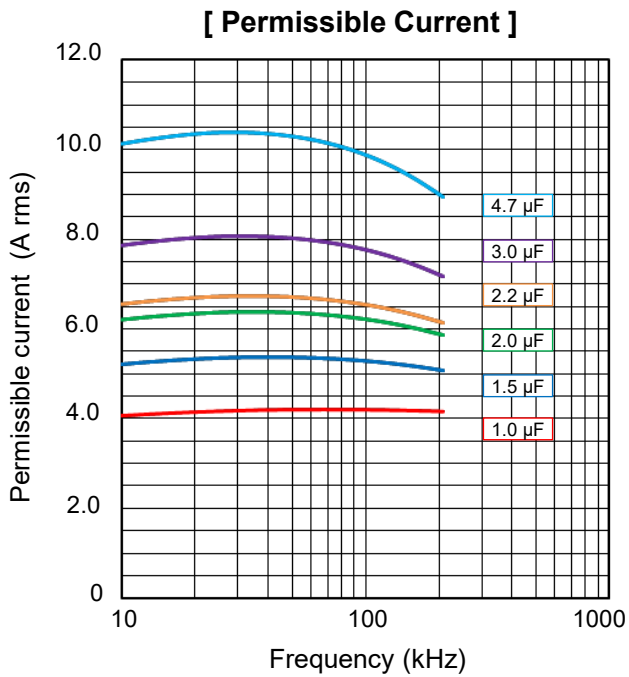

Permissible pulse current (dV/dt)
(Max. 10000 cycles)

R.voltage [DC] (V)	Capacitance (μF)	Code	dV/dt (V/μs)	Current (A _{o-p})
700	1.0	105	50	50.0
	1.5	155		75.0
	2.0	205		100.0
	2.2	225		110.0
	3.0	305		150.0
	3.9	395		195.0
	4.7	475		235.0

Characteristics data

■ **Rated voltage [DC] : 800 V**

Electrical characteristics <Typical data >

Temperature characteristics

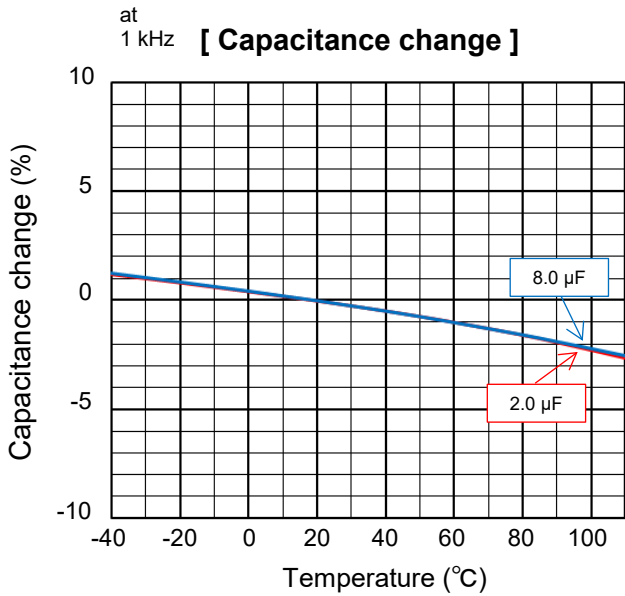

Frequency characteristics

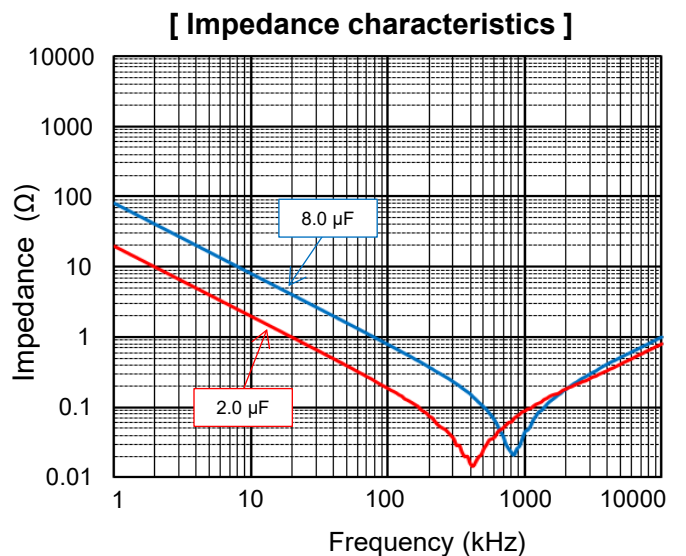
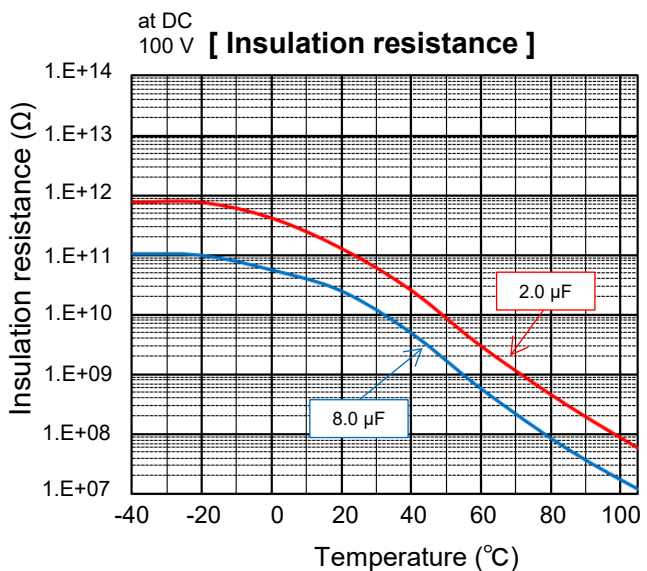
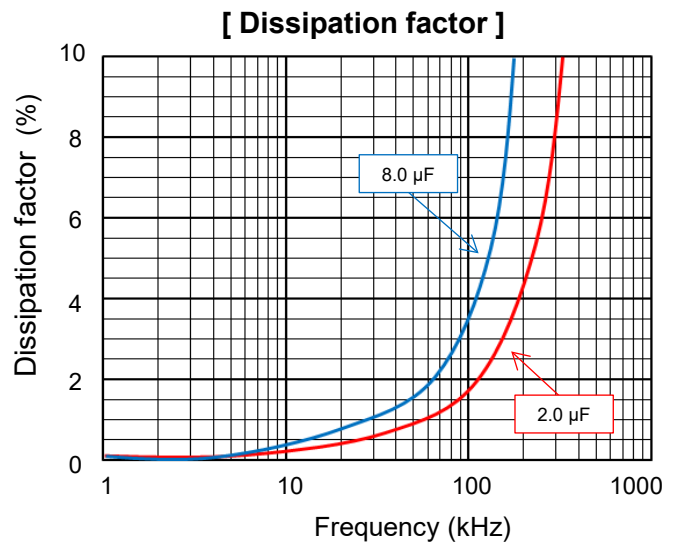
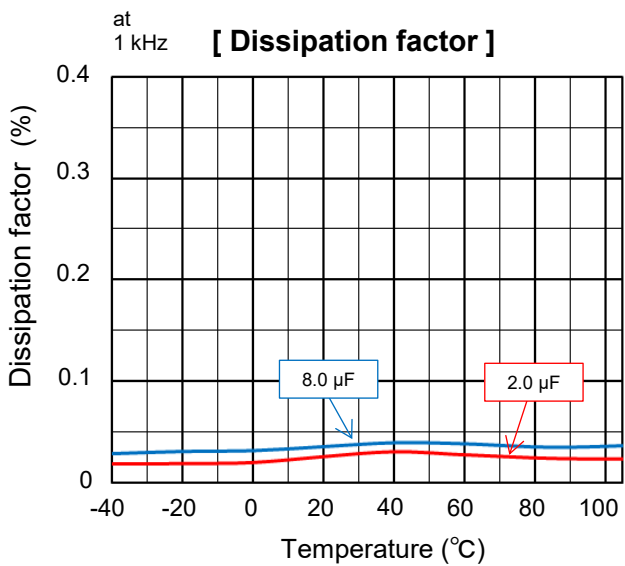
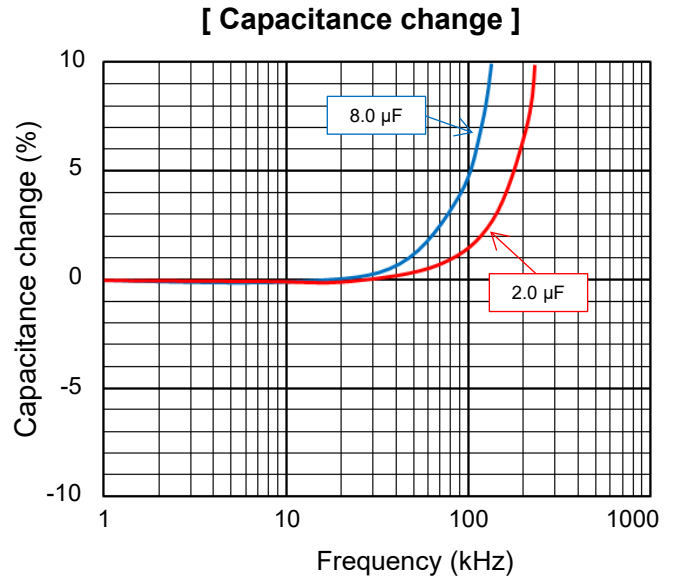

Design and specifications are each subject to change without notice. Ask factory for the current technical specifications before purchase and/or use.
Should a safety concern arise regarding this product, please be sure to contact us immediately.

Characteristics data

■ **Rated voltage [DC] : 800 V**

Applicable specifications

[Permissible Current]

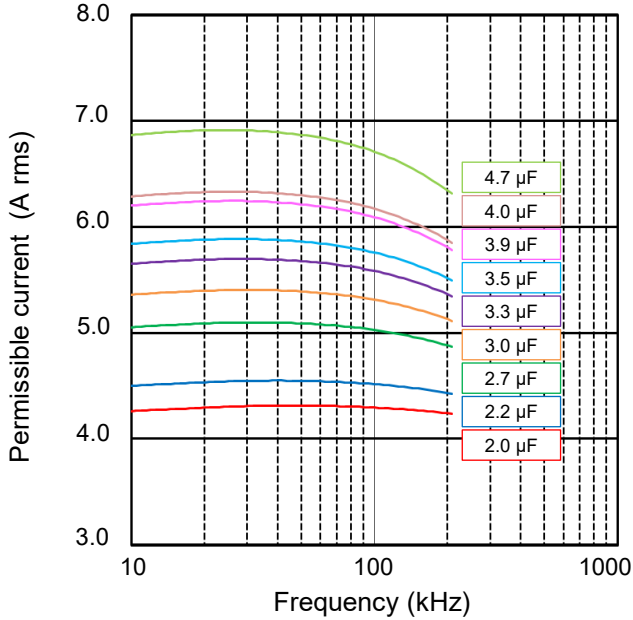

[Permissible Current Derating by Temperature]

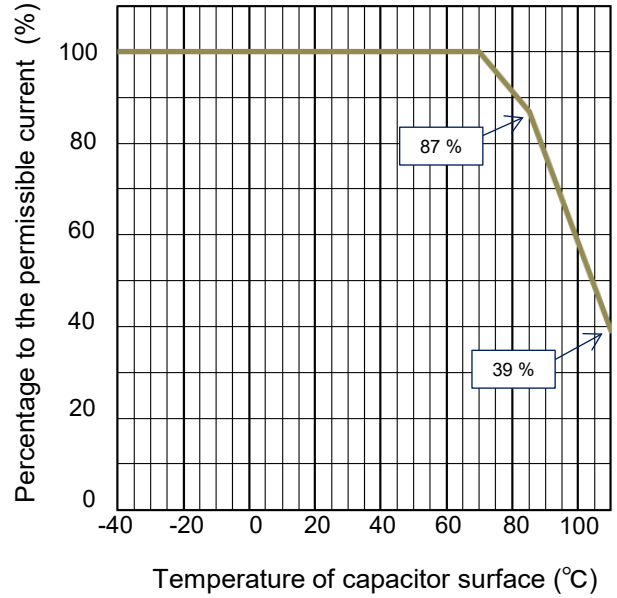

[Permissible Current]

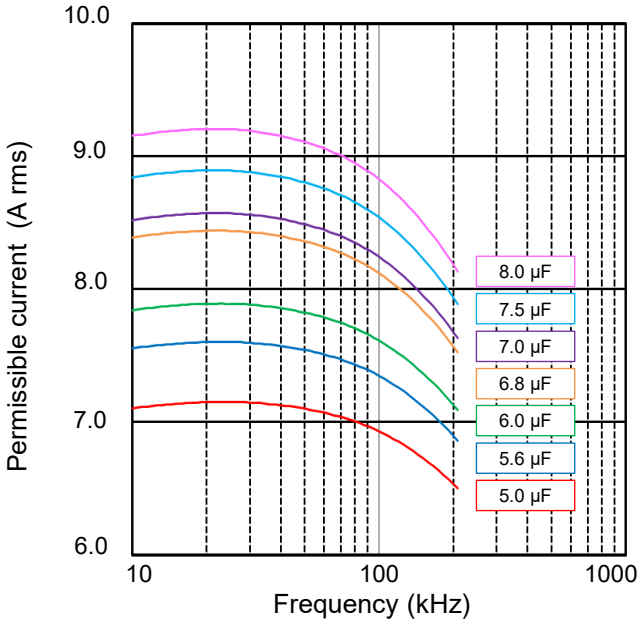

[Voltage Derating by Temperature]

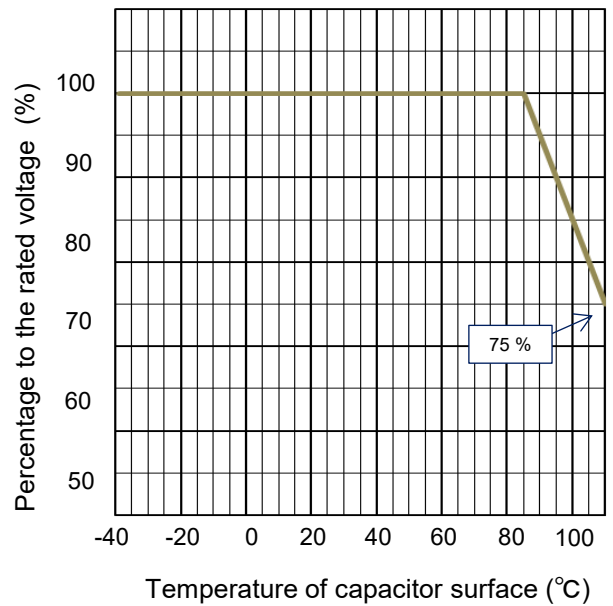

Permissible pulse current (dV/dt) (Max. 10000 cycles)

R.voltage [DC] (V)	Capacitance (μF)	Code	dV/dt (V/μs)	Current (Ao-p)
800	2.0	205	50	100.0
	2.2	225		110.0
	2.7	275		135.0
	3.0	305		150.0
	3.3	335		165.0
	3.5	355		175.0
	3.9	395		195.0
	4.0	405		200.0
	4.7	475		235.0

R.voltage [DC] (V)	Capacitance (μF)	Code	dV/dt (V/μs)	Current (Ao-p)
800	5.0	505	50	250.0
	5.6	565		280.0
	6.0	605		300.0
	6.8	685		340.0
	7.0	705		350.0
	7.5	755		375.0
	8.0	805		400.0

Characteristics data

■ **Rated voltage [DC] : 1100 V**

Electrical characteristics <Typical data >

Temperature characteristics

at 1 kHz [**Capacitance change**]

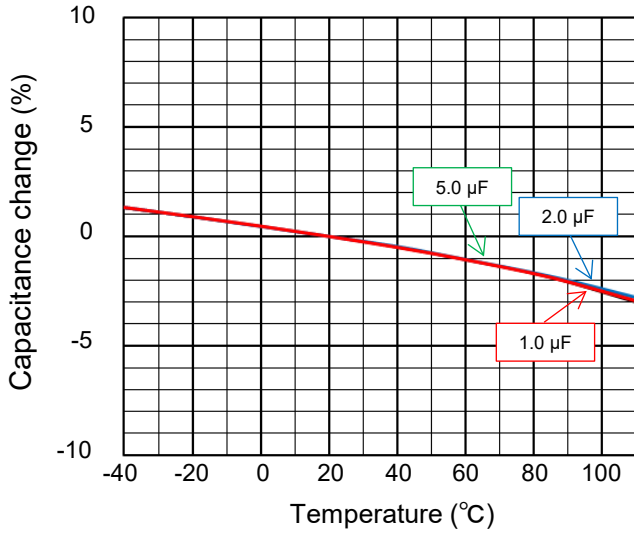

Frequency characteristics

[**Capacitance change**]

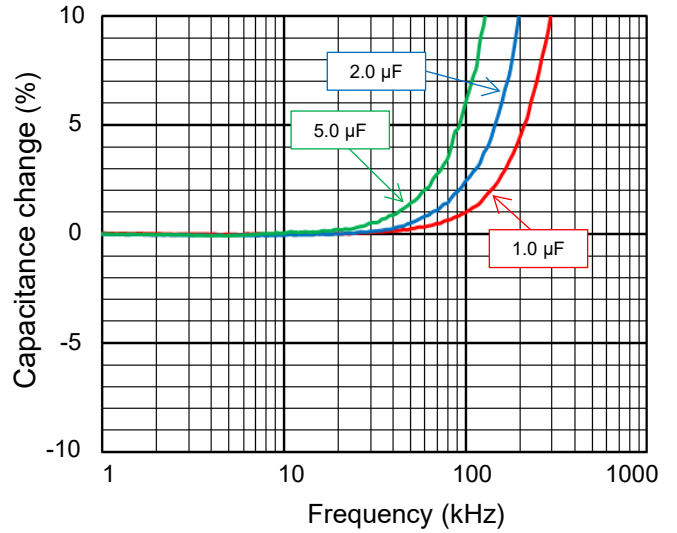

at 1 kHz [**Dissipation factor**]

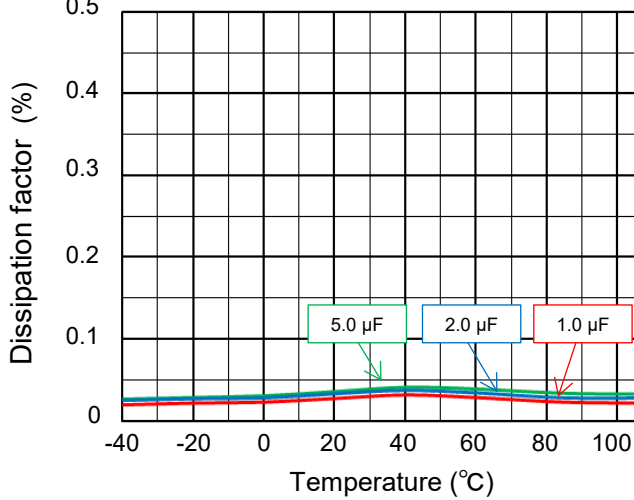

[**Dissipation factor**]

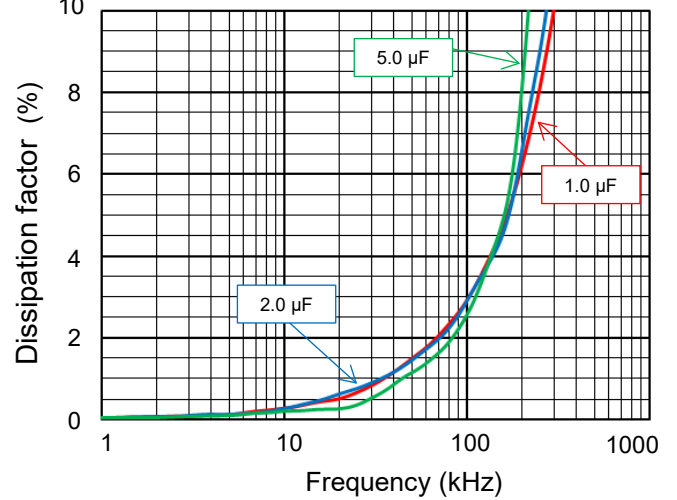

at DC 100 V [**Insulation resistance**]

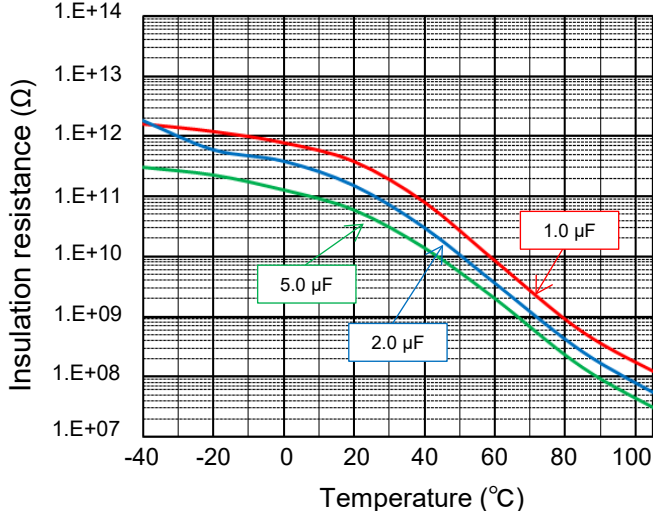

[**Impedance characteristics**]

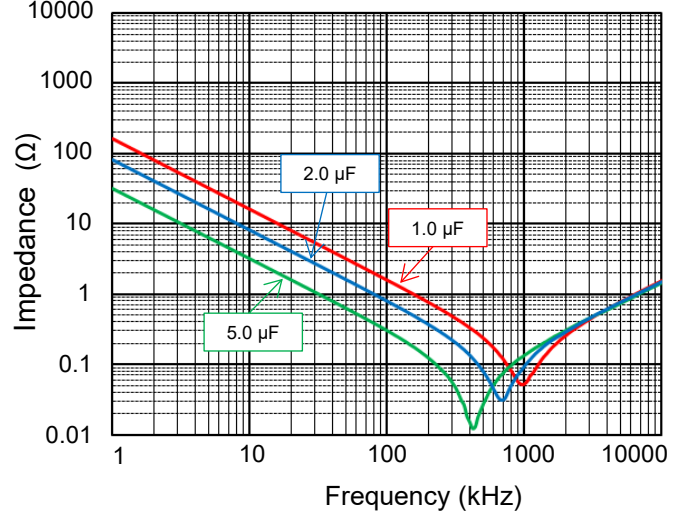

Characteristics data

■ **Rated voltage [DC] : 1100 V**

Applicable specifications

[Permissible Current]

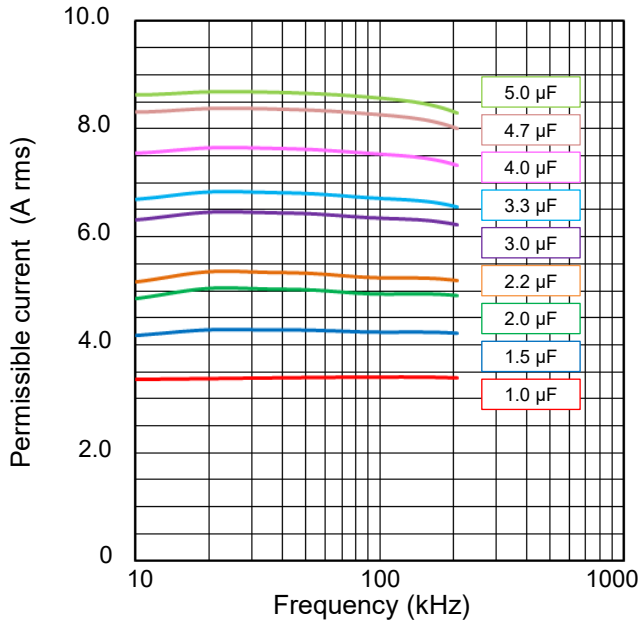

[Permissible Current Derating by Temperature]

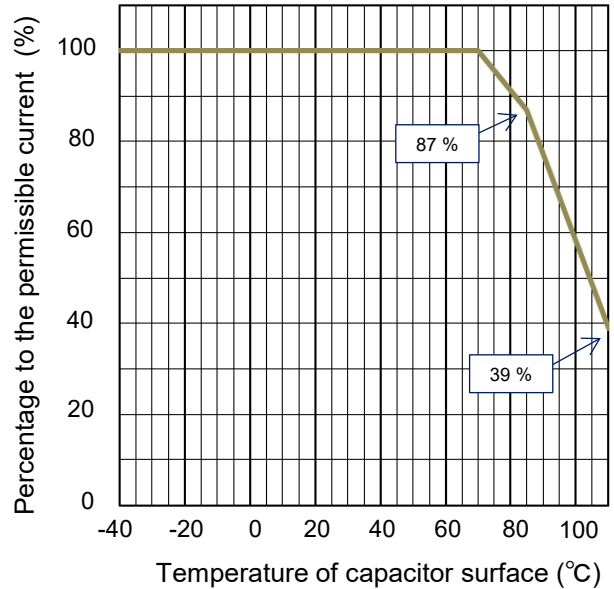

[Voltage Derating by Temperature]

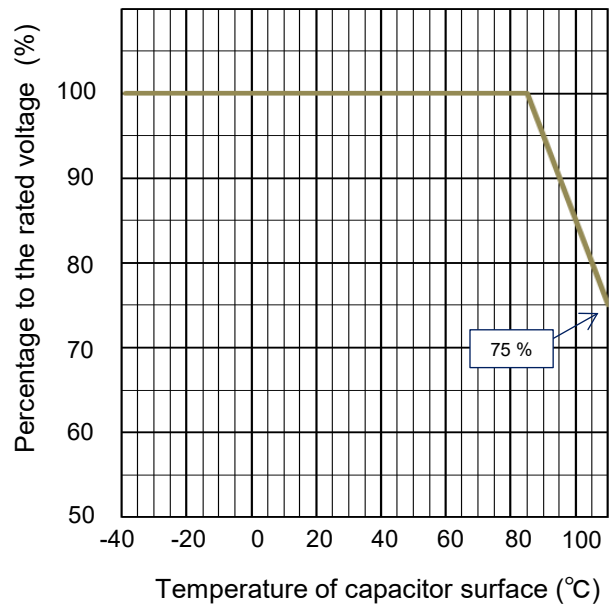

Permissible pulse current (dV/dt)
(Max. 10000 cycles)

R.voltage [DC] (V)	Capacitance (µF)	Code	dV/dt (V/µs)	Current (A _{o-p})
1100	1.0	105	100	100.0
	1.5	155		150.0
	2.0	205		200.0
	2.2	225		220.0
	3.0	305		300.0
	3.3	335		330.0
	4.0	405		400.0
	4.7	475		470.0
	5.0	505	500.0	

 This series is not a recommended product.
Not recommended for new design.

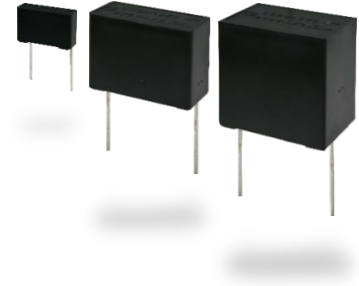

Plastic Film Capacitors

Metallized Polypropylene Film Capacitor (For Automotive)

ECQUA series [Class X2]

In accordance with UL/CSA and European safety regulation class X2 equipped with a safety mechanism.

Features

- High safety (safety function installed)
- High humidity resistance (85 °C, 85 %)
 - 275 V : 240 V, 1000 h / 275 V, 500 h
 - 310 V : 275 V, 1000 h
- High Thermal shock resistance (-40 ↔ 85°C, 1000 cycles)
- Flame-retardant plastic case and non-combustible resin
- AEC-Q200 compliant
- RoHS compliant

Recommended applications

- Interference suppressors for automotive

Explanation of part number

■ Standard

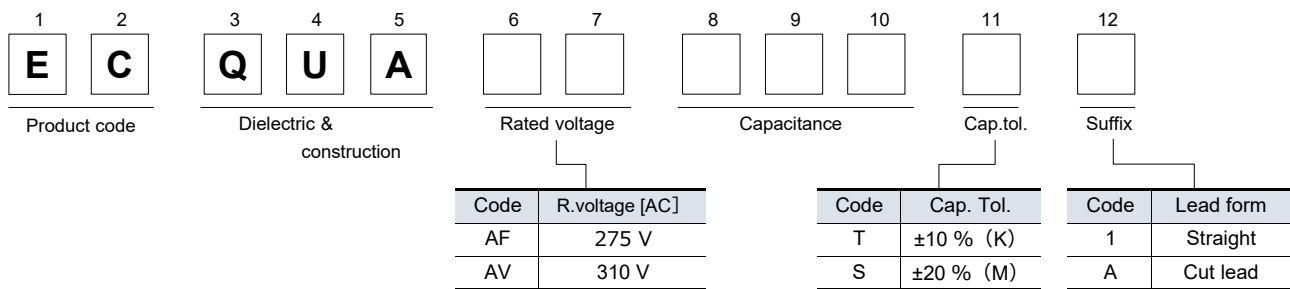

■ Special lead space product

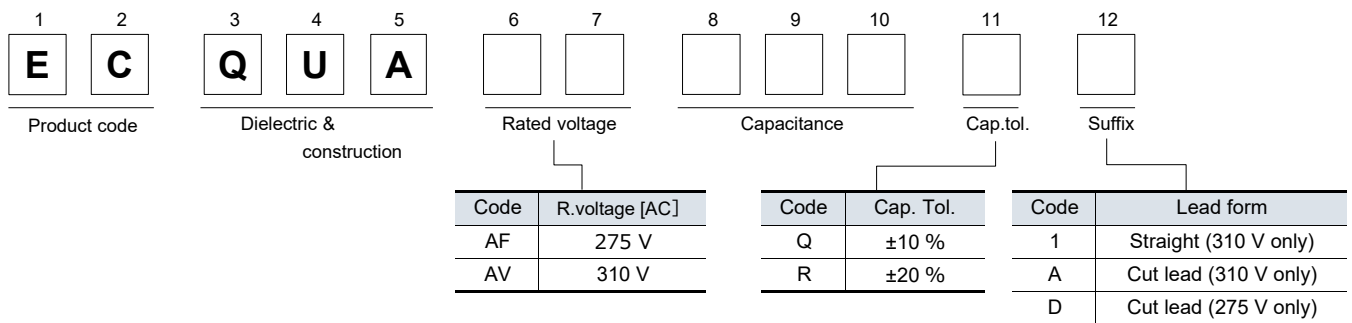

Applicable standard

* It is certified as type ECQUA in the following approval.

Approval		Class	Certification organization
UL	UL60384-14	Class X2	UL
CSA	CAN/CSA E60384-14	Class X2	
Europe	EN60384-14	Class X2	VDE or DEMKO
International	IEC60384-14	Class X2	

* When applying this capacitor to European and American safety standards, please use type designation and rating such as ECQUA, 0.1 μF.

* Approval number (File No.) of safety regulations are subject to revision without notice. Ask factory for a copy of the latest file No.

Specifications		
Category temp. range	-40 °C to +110 °C	
Rated voltage [AC]	275 V, 310 V	
Capacitance range	275 V	0.10 μF to 10.0 μF
	310 V	0.10 μF to 1.0 μF
Capacitance tolerance	±10 % (K), ±20 % (M)	
Dissipation factor (tan δ)	C ≤ 1.0 μF : tan δ ≤ 0.1 % (20 °C, 1 kHz) C > 1.0 μF : tan δ ≤ 0.2 % (20 °C, 1 kHz)	
Withstand voltage	275 V	Between terminals : 633 V [AC], 1183 V [DC], 60 s Between terminals to enclosure : 2050 V [AC], 60 s
	310 V	Between terminals : 713 V [AC], 1768 V [DC], 60 s Between terminals to enclosure : 2120 V [AC], 60 s
Insulation resistance (IR)	C ≤ 0.33 μF : IR ≥ 15,000 MΩ (20 °C, 100 V [DC], 60 s) C > 0.33 μF : IR ≥ 5,000 MΩ · μF (20 °C, 100 V [DC], 60 s) C ≤ 0.47 μF : IR ≥ 2,000 MΩ (20 °C, 500 V [DC], 60 s)	
Maximum AC voltage * *	310 V [AC]	

* Use of this capacitor is limited to AC voltage (50 Hz or 60 Hz sine wave).
 * A faint corona discharge may occur inside of the capacitor element at rated voltage, however there is no influence on the reliability of the capacitor.
 * * Maximum AC voltage including line voltage fluctuation is 310 V [AC].
 310 V [AC] is not nominal continuous applied voltage, but only indicates maximum value including in the voltage of the power supply.
 Basic nominal voltage is considered as 240 V [AC].
 This maximum AC voltage is specified in only ECQUA type, not specified in other types.
 Please refer to individual product specification, and contact us for further questions regarding design life.

Dimensions

Marking example

Style	(A) side	(B) or (C) side
1		
2		
3		

Note : Only ±10 % as cap. tol. be marked as "K".
 Note: Date code.

Unit:mm

ECQUA (For automotive) series

Rating · Dimensions · Quantity

■ Rated.voltage [AC] : 275 V, Capacitance tolerance : ±10 %(K), ±20 %(M)

Part No.	Cap. (μ F)	Dimensions (mm)							Style	Min. order Q'ty (PCS)	
		L	T	H	F	ϕ d	P	Q		Straight	Cut lead
ECQUAAF104T()	0.10	17.5	5.0	12.0	15.0	0.6	0±0.8	1.3	1	1000	1000
ECQUAAF104S()											
ECQUAAF154T()	0.15	17.5	6.0	13.0	15.0	0.6	0±0.8	1.3	1		
ECQUAAF154S()											
ECQUAAF224T()	0.22	17.5	7.5	14.0	15.0	0.6	0±0.8	1.3	1		
ECQUAAF224S()											
ECQUAAF334T()	0.33	17.5	9.0	16.0	15.0	0.6	0±0.8	1.3	1		
ECQUAAF334S()											
ECQUAAF474T()	0.47	26.0	8.5	15.0	22.5	0.8	0±0.8	1.8	1	600	800
ECQUAAF474S()											
ECQUAAF684T()	0.68	26.0	10.0	17.0	22.5	0.8	0±0.8	1.8	1	500	500
ECQUAAF684S()											
ECQUAAF105T()	1.0	26.0	12.0	19.0	22.5	0.8	0±0.8	1.8	1	300	300
ECQUAAF105S()											
ECQUAAF155T()	1.5	31.0	12.0	22.0	27.5	0.8	0±0.8	1.8	1	200	200
ECQUAAF155S()											
ECQUAAF225T()	2.2	31.0	14.5	24.5	27.5	0.8	0±0.8	1.8	1		
ECQUAAF225S()											
ECQUAAF335T()	3.3	31.0	19.0	29.0	27.5	0.8	0±0.8	1.8	1	150	150
ECQUAAF335S()											
ECQUAAF335QD	3.3	41.0	15.0	30.0	37.5	1.0	0±0.8	1.8	2	—	120
ECQUAAF335RD											
ECQUAAF475T()	4.7	31.0	23.0	33.0	27.5	0.8	0±0.8	1.8	1	100	100
ECQUAAF475S()											
ECQUAAF475QD	4.7	41.0	18.0	33.0	37.5	1.0	0±0.8	1.8	2	—	95
ECQUAAF475RD											
ECQUAAF685TA	6.8	41.0	23.0	37.5	37.5	1.0	0±0.8	1.8	2	—	60
ECQUAAF685SA											
ECQUAAF106TA	10.0	41.0	28.0	42.5	37.5	1.0	0±0.8	1.8	2	—	50
ECQUAAF106SA											

* () : Suffix for lead crimped

Note) Part number marked with bold is special lead space product.

Rating · Dimensions · Quantity

■ Rated voltage [AC] : 310 V, Capacitance tolerance : ±10 %(K), ±20 %(M)

Part No.	Cap. (μ F)	Dimensions (mm)							Style	Min. order Q'ty (PCS)	
		L	T	H	F	ϕ d	P	Q		Straight	Cut lead
ECQUAAV104T()	0.1	18.5	8.0	12.5	15.0	0.6	0±0.8	1.8	3	1000	1000
ECQUAAV104S()											
ECQUAAV124T()	0.12	18.5	8.0	12.5	15.0	0.6	0±0.8	1.8	3	1000	1000
ECQUAAV124S()											
ECQUAAV154T()	0.15	18.5	8.0	12.5	15.0	0.6	0±0.8	1.8	3	1000	1000
ECQUAAV154S()											
ECQUAAV184T()	0.18	18.5	8.0	16.5	15.0	0.6	0±0.8	1.8	3	900	1000
ECQUAAV184S()											
ECQUAAV224T()	0.22	18.5	8.0	16.5	15.0	0.6	0±0.8	1.8	3	900	1000
ECQUAAV224S()											
ECQUAAV224Q()	0.22	26.0	7.0	14.0	22.5	0.8	0±0.8	1.8	3	900	900
ECQUAAV224R()											
ECQUAAV274T()	0.27	18.5	9.0	18.0	15.0	0.6	0±0.8	1.8	3	700	800
ECQUAAV274S()											
ECQUAAV274Q()	0.27	26.0	8.0	15.0	22.5	0.8	0±0.8	1.8	3	700	800
ECQUAAV274R()											
ECQUAAV334T()	0.33	18.5	9.0	18.0	15.0	0.6	0±0.8	1.8	3	700	800
ECQUAAV334S()											
ECQUAAV334Q()	0.33	26.0	8.0	15.0	22.5	0.8	0±0.8	1.8	3	700	800
ECQUAAV334R()											
ECQUAAV394T()	0.39	18.5	11.0	20.0	15.0	0.6	0±0.8	1.8	3	500	600
ECQUAAV394S()											
ECQUAAV394Q()	0.39	26.0	9.0	16.0	22.5	0.8	0±0.8	1.8	3	600	700
ECQUAAV394R()											
ECQUAAV474T()	0.47	26.0	9.0	16.0	22.5	0.8	0±0.8	1.8	3	600	700
ECQUAAV474S()											
ECQUAAV564T()	0.56	26.0	12.0	19.0	22.5	0.8	0±0.8	1.8	3	400	500
ECQUAAV564S()											
ECQUAAV684T()	0.68	26.0	12.0	19.0	22.5	0.8	0±0.8	1.8	3	400	500
ECQUAAV684S()											
ECQUAAV824T()	0.82	26.0	14.0	21.0	22.5	0.8	0±0.8	1.8	3	300	300
ECQUAAV824S()											
ECQUAAV105T()	1.0	26.0	14.0	21.0	22.5	0.8	0±0.8	1.8	3	300	300
ECQUAAV105S()											

* () : Suffix for lead crimped

Note) Part number marked with bold is special lead space product.

Characteristics data

■ **Rated voltage [AC] : 275 V**

Electrical characteristics <Typical data >

Temperature characteristics

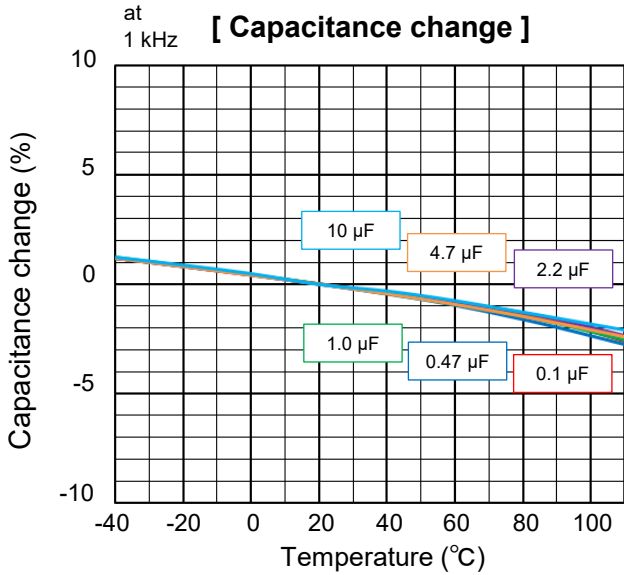

Frequency characteristics

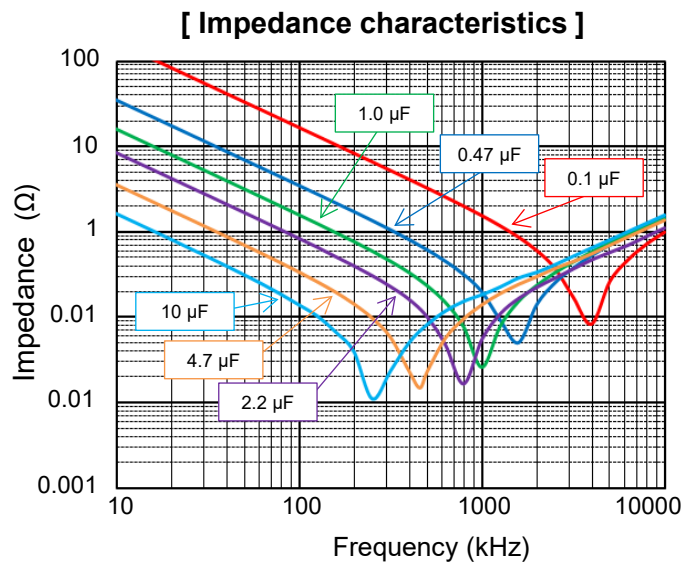
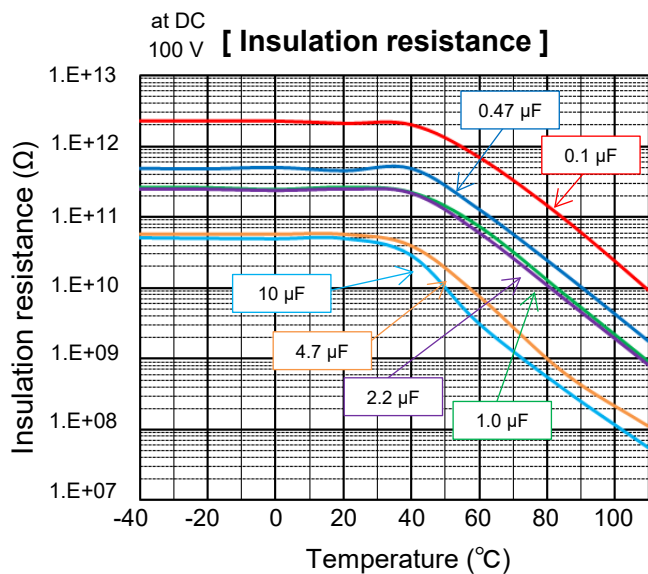
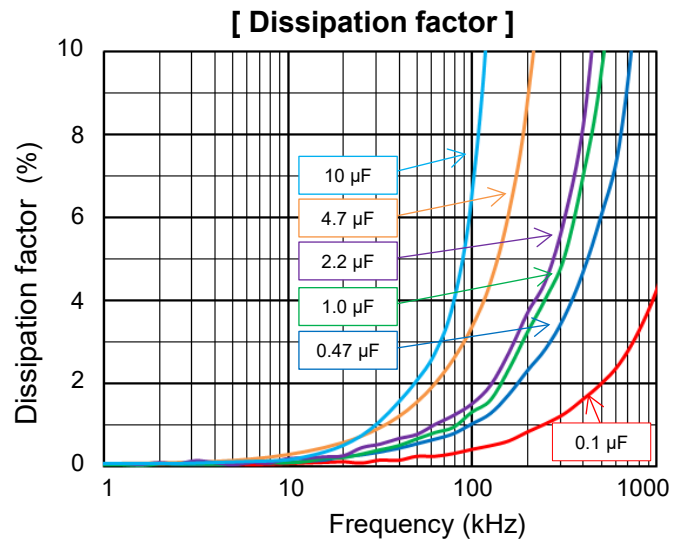
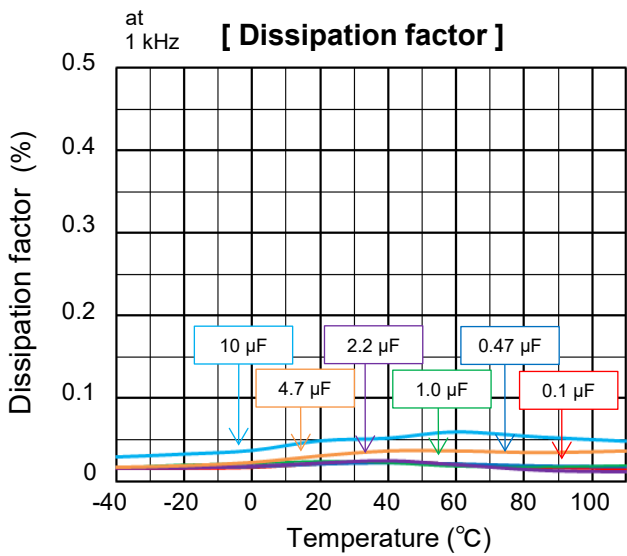
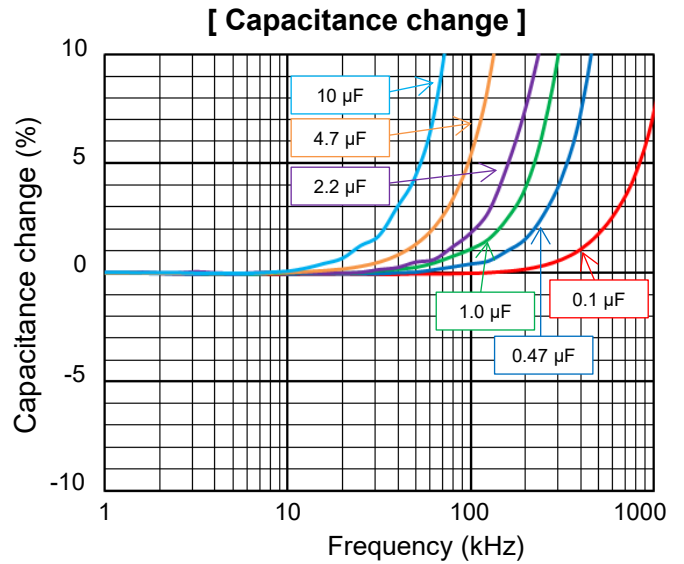

Characteristics data

■ Rated voltage [AC] : 310 V

Electrical characteristics <Typical data >

Temperature characteristics

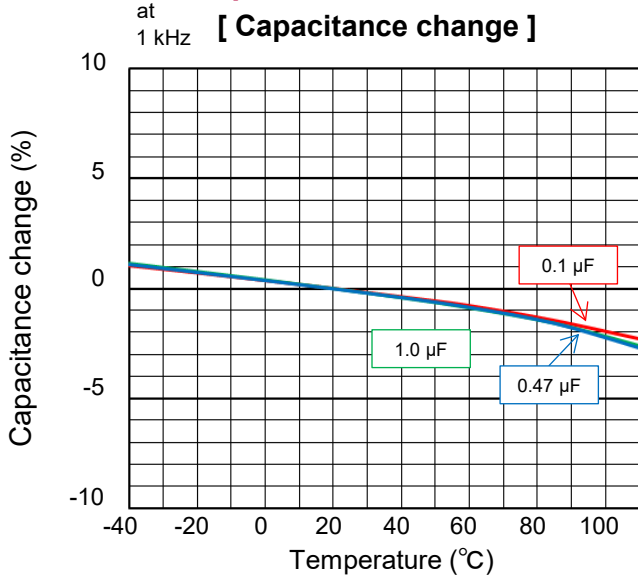

Frequency characteristics

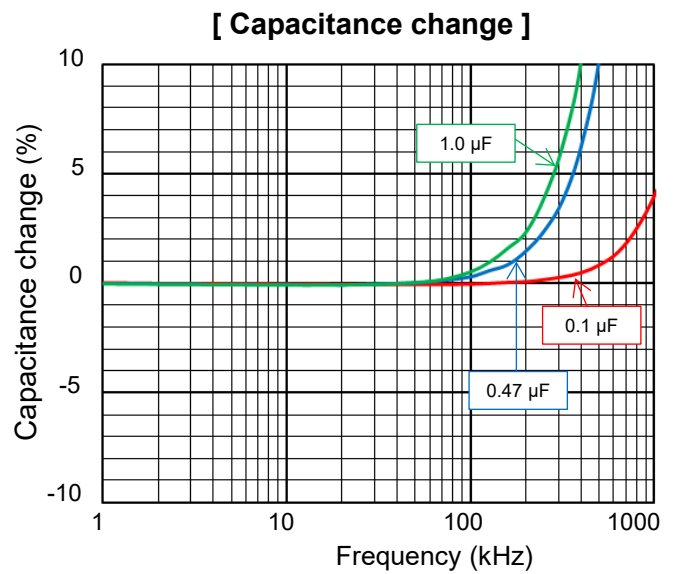

at 1 kHz [Dissipation factor]

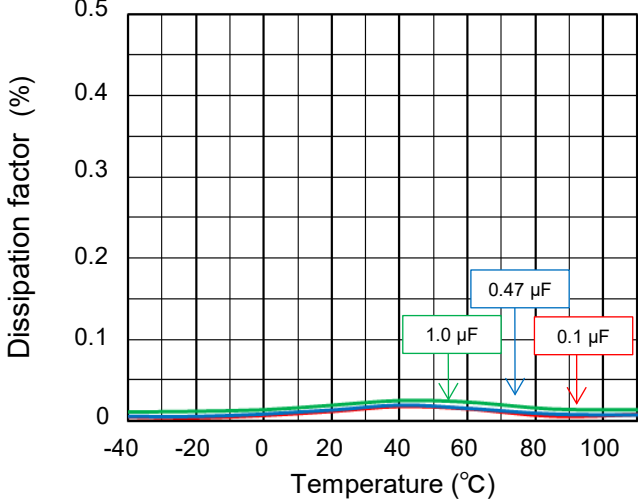

[Dissipation factor]

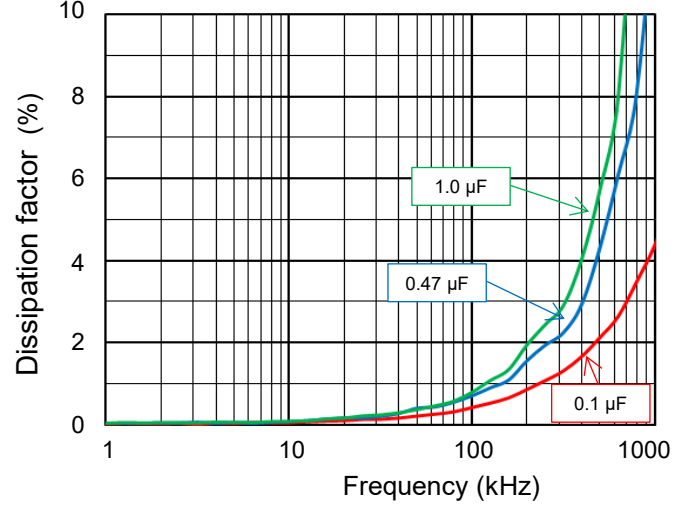

at DC 100 V [Insulation resistance]

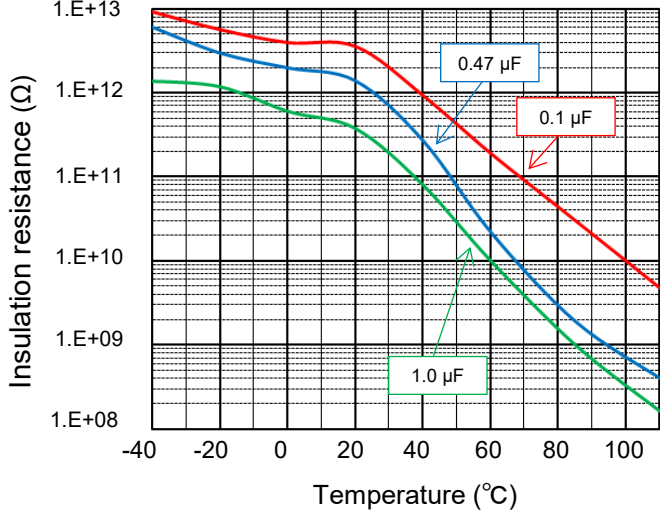

[Impedance characteristics]

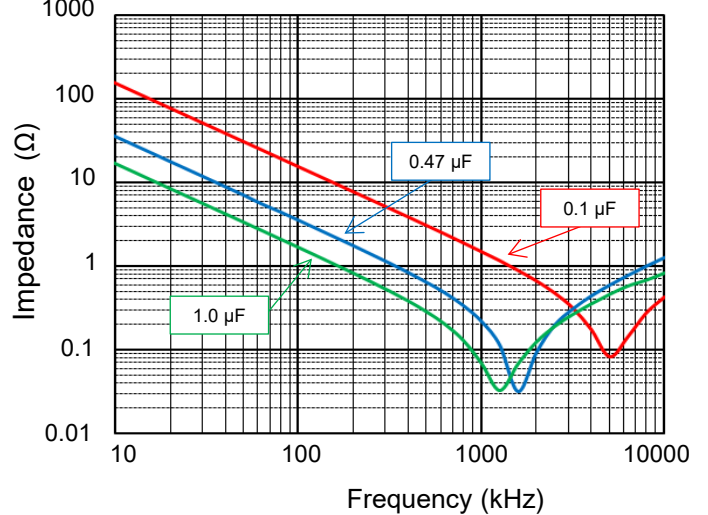

 This series is not a recommended product.
Not recommended for new design.

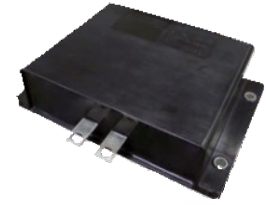

Plastic Film Capacitors

DC-Link Film Capacitor

TYPE 1

Features

- High safety, Self-healing and Self-protecting function built in.
- No catastrophic failure upon natural end of life due to inbuilt fuse function.
- Open circuit failure mode by fuse function patterned electrode.
- Can replace electrolytic capacitor.
- Low ESR, High ripple current capability
- Low ESL
- RoHS compliant

Recommended applications

- Any automotive and/or other application requiring DC Linkage
※Verify the usage and fitting environments, and make sure to observe the rated performance specified in the corresponding specifications.

Construction

- Dielectric : Polypropylene
- Electrode : Metallized dielectric with segment pattern
- Plastic case : PPS. equivalent to UL94 V-0
- Sealing : Epoxy Resin equivalent to UL94 HB
- Terminal : Copper with tin plating

Explanation of part number

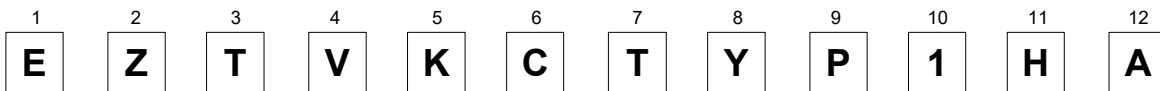

Specifications

Operating temperature on the surface of the case	- 40 °C to +105 °C (including self heat generation)
Capacitance	581 μF (+10 %/- 5 %) at 1 kHz, 25 °C
Rated voltage [DC]	450 V
Maximum voltage [DC]	600 V for 60 sec in life time
Rated ripple current	Continuous 80 A rms at 10 kHz
Current derating	Refer Fig.1
ESR	≤ 0.8 mΩ at 10 kHz
ESL	≤ 20 nH at 1 MHz
Insulation resistance between terminals and case	1 GΩ or more measure after applying 500 V [DC] for 2 seconds.
Dimensions L x W x H (Typical data)	164 × 115 × 43.1 mm : Excluding terminals
Weight (Typical data)	980 g

*1 : Voltage includes ripple voltage

*2 : Derate the current when the maximum surface temperature exceeds 95 degC, as shown in Fig. 1.

Characteristics <Reference>

< Temperature characteristics (Typical curve)>

- Change of capacitance ($\Delta C/C$)

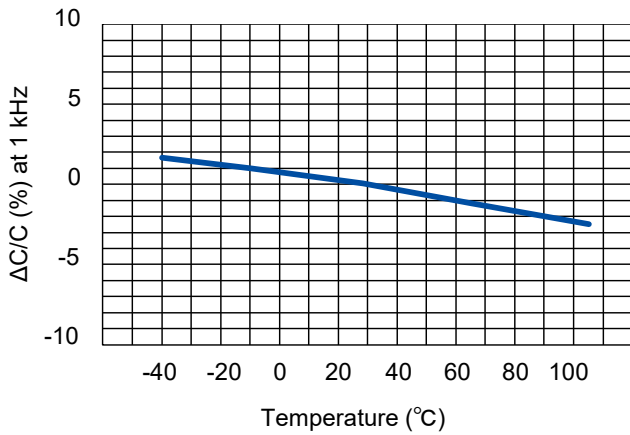

- Equivalent series resistance (ESR)

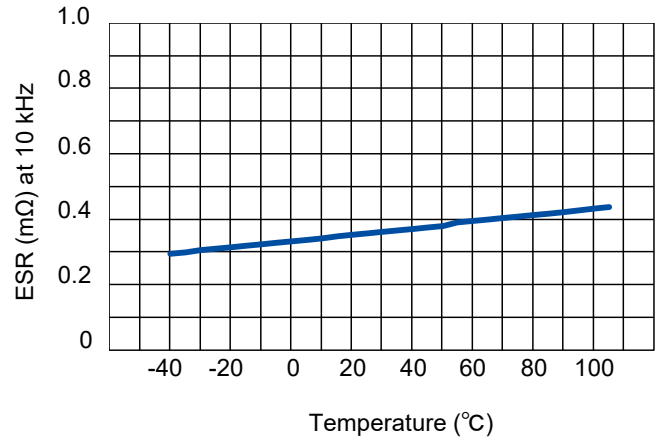

< Frequency characteristics (Typical curve)>

- Equivalent series resistance (ESR)

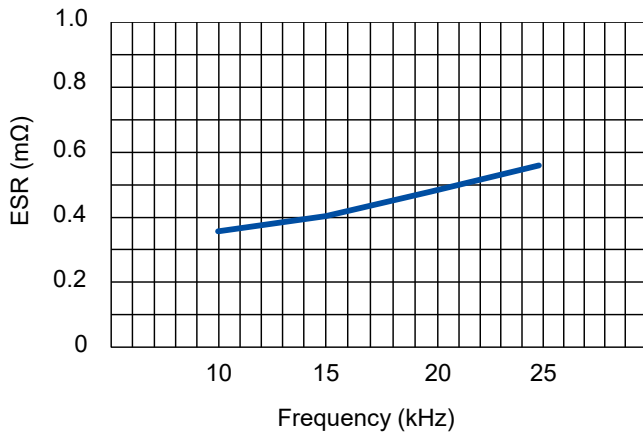

< Lifetime Expectancy (Reference)>

- * Expected life : 15,000 hours
- * Failure in time : 300 Fits

The above values are reference calculated under an pre-assumed average operating condition.

Plastic Film Capacitors

Metallized Polypropylene Film Capacitor

EZPE series

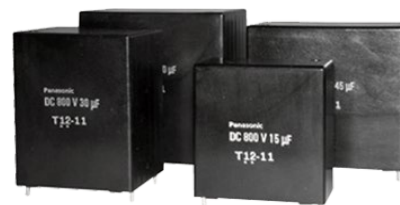

Features

- High safety, Self-healing and Self-protecting function built-in
- Long product life, High reliability
- Low loss, Low ESR
- Flame retardant (Case and sealing resin)
- RoHS compliant

Recommended applications

For DC filtering, DC link circuit

- Solar inverters
- Wind power generation
- Industrial power supplies
- Inverter circuit in appliances (Air Conditioners etc.)

Construction

- Dielectric : Polypropylene film
- Electrodes : Metallized dielectric with segmented pattern
- Plastic case : UL94 V-0
- Sealing : UL94 V-0
- Terminals : Tinned wires, 2-pin and 4-pin versions

Explanation of part number

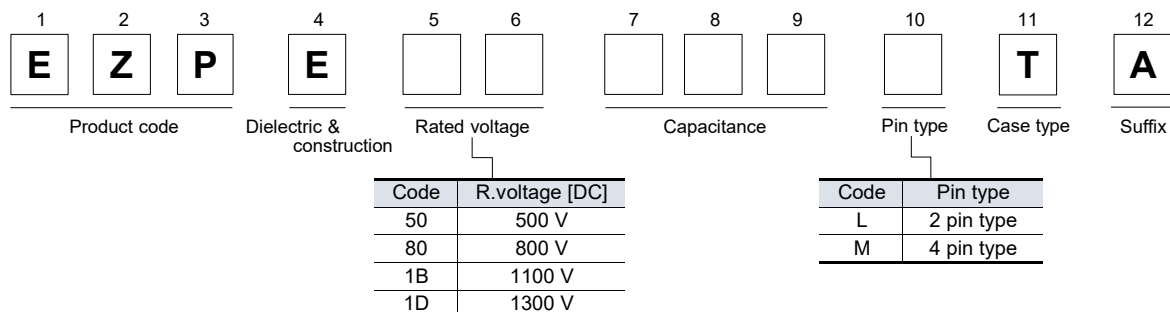

Specifications

Category temperature range ^{*1}	-40 °C to +85 °C	
Rated voltage ^{*2} [DC]	500 V, 800 V, 1100 V, 1300 V (Derating of rated voltage by more than 70 °C ^{*3})	
Rated capacitance	500 V	10 µF to 110 µF
	800 V	10 µF to 60 µF
	1100 V	10 µF to 40 µF
	1300 V	10 µF to 25 µF
Capacitance tolerance	±10 %	
Withstand voltage	Between terminals : Rated voltage (V) × 150 % 10 s	
	Terminal to case : 2110 V [AC] (50 Hz or 60 Hz), 10 s	
Insulation resistanc (IR)	CR ≥ 10,000 Ω·F (20 °C, 500 V [DC], 60 s)	

*1 : The temperature of capacitor surface (case)

*2 : Use for DC voltage only

*3 : Refer to the page of "DC voltage derating"

Dimensions

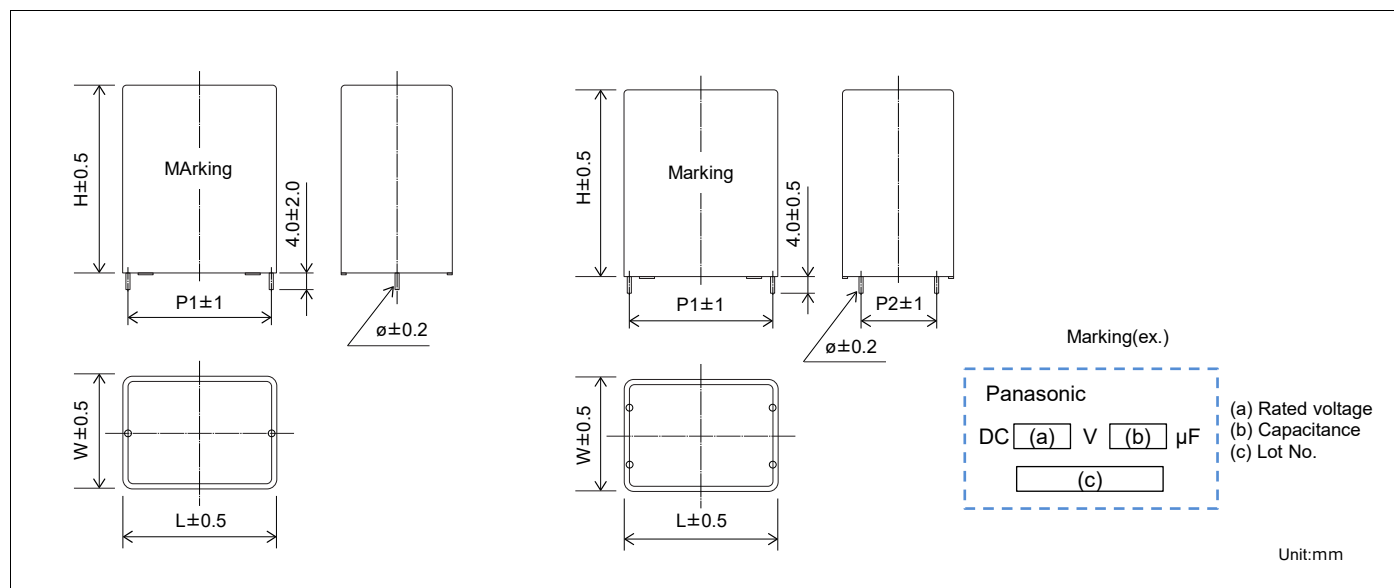

Rating · Dimensions · Quantity

■ Rated voltage [DC] : 500 V at 70 °C (450 V at 85 °C)

Part No.	Capacitance (μ F)	Dimensions (mm)						dv/dt [V/ μ s]	Permissible current		ESR ^{*3} (m Ω)	tan δ ^{*4} (%)	Mass (g)	Min. order Qty ^{*5} (PCS)
		W	H	L	P1	P2	ϕ		Peak current ^{*1} (A _{c-p})	RMS current ^{*2} (A rms)				
EZPE50106LTA	10	20	42	41.5	37.5	—	1.2	21	210	5.0	22.0	0.28	45	600
EZPE50156LTA	15	20	42	41.5	37.5	—	1.2	21	315	7.5	14.8	0.28	45	
EZPE50206LTA	20	20	42	41.5	37.5	—	1.2	21	420	9.5	11.0	0.28	44	
EZPE50256LTA	25	20	42	41.5	37.5	—	1.2	21	525	11.0	8.8	0.28	43	
EZPE50306MTA	30	20	42	41.5	37.5	10.2	1.2	21	630	12.5	7.0	0.28	43	
EZPE50356MTA	35	30	51	41.5	37.5	10.2	1.2	21	735	13.5	6.2	0.28	83	400
EZPE50406MTA	40	30	51	41.5	37.5	10.2	1.2	21	840	14.5	5.4	0.28	82	
EZPE50456MTA	45	30	51	41.5	37.5	10.2	1.2	21	945	15.2	4.9	0.28	81	
EZPE50506MTA	50	30	51	41.5	37.5	20.3	1.2	21	1050	16.0	4.4	0.28	80	
EZPE50556MTA	55	30	51	41.5	37.5	20.3	1.2	21	1155	16.3	4.1	0.28	79	
EZPE50606MTA	60	30	51	41.5	37.5	20.3	1.2	21	1260	16.5	3.9	0.28	77	200
EZPE50656MTA	65	30	51	57.5	52.5	10.2	1.2	14	910	15.0	6.8	0.44	111	
EZPE50706MTA	70	30	51	57.5	52.5	10.2	1.2	14	980	15.5	6.5	0.44	109	
EZPE50756MTA	75	30	51	57.5	52.5	20.3	1.2	14	1050	16.0	6.0	0.44	108	
EZPE50806MTA	80	30	51	57.5	52.5	20.3	1.2	14	1120	16.5	5.7	0.44	106	
EZPE50856MTA	85	35	56	57.5	52.5	20.3	1.2	14	1190	16.7	5.4	0.44	142	200
EZPE50906MTA	90	35	56	57.5	52.5	20.3	1.2	14	1260	17.0	5.1	0.44	141	
EZPE50956MTA	95	35	56	57.5	52.5	20.3	1.2	14	1330	17.5	4.9	0.44	140	
EZPE50107MTA	100	35	56	57.5	52.5	20.3	1.2	14	1400	18.0	4.7	0.44	139	
EZPE50117MTA	110	35	56	57.5	52.5	20.3	1.2	14	1540	18.5	4.4	0.44	138	

*1 : When rising temperature of capacitor surface by continuous peak current (included pulse current), use within limit specified for temperature of capacitor surface and self heating temperature rise.

*2 : Maximum RMS current @70 °C, 10 kHz
Use within limit for self heating temperature rise at capacitor surface.

*3 : Typical values @ 20 °C, 10 kHz ESR : less than 2.5×ESR typ

*4 : Maximum dissipation factor @ 20 °C, 1 kHz

*5 : Minimum order quantity consists of 4 packing units.

Rating · Dimensions · Quantity

■ Rated voltage [DC] : 800 V at 70 °C (700 V at 85 °C)

Part No.	Capacitance (μF)	Dimensions (mm)						dv/dt [V/μs]	Permissible current		ESR ^{*3} (mΩ)	tan δ ^{*4} (%)	Mass (g)	Min. order Q'ty ^{*5} (PCS)
		W	H	L	P1	P2	ø		Peak current ^{*1} (A _{o-p})	RMS current ^{*2} (A rms)				
EZPE80106LTA	10	20	42	41.5	37.5	–	1.2	22	220	7	15.8	0.22	44	600
EZPE80156MTA	15	20	42	41.5	37.5	10.2	1.2	22	330	9	10.5	0.22	43	
EZPE80206MTA	20	30	51	41.5	37.5	10.2	1.2	22	440	11	7.7	0.22	82	400
EZPE80256MTA	25	30	51	41.5	37.5	10.2	1.2	22	550	13	6.8	0.22	80	
EZPE80306MTA	30	30	51	41.5	37.5	20.3	1.2	22	660	15	5.3	0.22	78	200
EZPE80356MTA	35	30	51	57.5	52.5	10.2	1.2	15	525	12	9.7	0.33	110	
EZPE80406MTA	40	30	51	57.5	52.5	20.3	1.2	15	600	13	8.3	0.33	107	
EZPE80456MTA	45	30	51	57.5	52.5	20.3	1.2	15	675	14	7.0	0.33	104	
EZPE80506MTA	50	35	56	57.5	52.5	20.3	1.2	15	750	15	6.3	0.33	140	
EZPE80556MTA	55	35	56	57.5	52.5	20.3	1.2	15	825	16	5.9	0.33	138	
EZPE80606MTA	60	35	56	57.5	52.5	20.3	1.2	15	900	17	5.6	0.33	136	

■ Rated voltage [DC] : 1100 V at 70 °C (920 V at 85 °C)

Part No.	Capacitance (μF)	Dimensions (mm)						dv/dt [V/μs]	Permissible current		ESR ^{*3} (mΩ)	tan δ ^{*4} (%)	Mass (g)	Min. order Q'ty ^{*5} (PCS)
		W	H	L	P1	P2	ø		Peak current ^{*1} (A _{o-p})	RMS current ^{*2} (A rms)				
EZPE1B106MTA	10	20	42	41.5	37.5	10.2	1.2	54	540	7.0	12.3	0.20	43	600
EZPE1B156MTA	15	30	51	41.5	37.5	10.2	1.2	54	810	8.5	8.2	0.20	80	
EZPE1B206MTA	20	30	51	41.5	37.5	20.3	1.2	54	1080	10.0	6.3	0.20	76	400
EZPE1B256MTA	25	30	51	57.5	52.5	10.2	1.2	35	875	8.0	10.7	0.28	107	
EZPE1B306MTA	30	30	51	57.5	52.5	20.3	1.2	35	1050	9.0	8.5	0.28	103	200
EZPE1B356MTA	35	35	56	57.5	52.5	20.3	1.2	35	1225	10.0	7.2	0.28	137	
EZPE1B406MTA	40	35	56	57.5	52.5	20.3	1.2	35	1400	11.0	6.5	0.28	134	

■ Rated voltage [DC] : 1300 V at 70 °C (1100 V at 85 °C)

Part No.	Capacitance (μF)	Dimensions (mm)						dv/dt [V/μs]	Permissible current		ESR ^{*3} (mΩ)	tan δ ^{*4} (%)	Mass (g)	Min. order Q'ty ^{*5} (PCS)
		W	H	L	P1	P2	ø		Peak current ^{*1} (A _{o-p})	RMS current ^{*2} (A rms)				
EZPE1D106MTA	10	30	51	41.5	37.5	10.2	1.2	73	730	12.0	10.0	0.17	80	400
EZPE1D156MTA	15	30	51	57.5	52.5	10.2	1.2	50	750	10.0	14.5	0.22	109	200
EZPE1D206MTA	20	30	51	57.5	52.5	20.3	1.2	50	1000	14.0	11.1	0.22	103	
EZPE1D256MTA	25	35	56	57.5	52.5	20.3	1.2	50	1250	17.0	8.5	0.22	136	

*1 : When rising temperature of capacitor surface by continuous peak current (included pulse current), use within limit specified for temperature of capacitor surface and self heating temperature rise.

*2 : Maximum RMS current @70 °C, 10 kHz
Use within limit for self heating temperature rise at capacitor surface.

*3 : Typical values @ 20 °C, 10 kHz ESR : less than 2.5×ESR typ

*4 : Maximum dissipation factor @ 20 °C, 1 kHz

*5 : Minimum order quantity consists of 4 packing units.

Plastic Film Capacitors

Metallized Polypropylene Film Capacitor

EZPE series (Low profile type)



Features

- High safety, Self-healing and Self-protecting function built-in
- Long product life, High reliability, High moisture resistance
- Low loss, Low ESR
- Flame retardant (Case and sealing resin)
- Low profile design
- RoHS compliant

Recommended applications

For DC filtering, DC link circuit

- Solar inverters, Micro inverters
- Wind power generation
- Industrial power supplies
- Inverter circuit in appliances (Air Conditioners etc.)

Construction

- Dielectric : Polypropylene film
- Electrodes : Metallized dielectric with segmented pattern
- Plastic case : UL94 V-0
- Sealing : UL94 V-0
- Terminals : Tinned wires, 2-pin and 4-pin versions

Explanation of part number

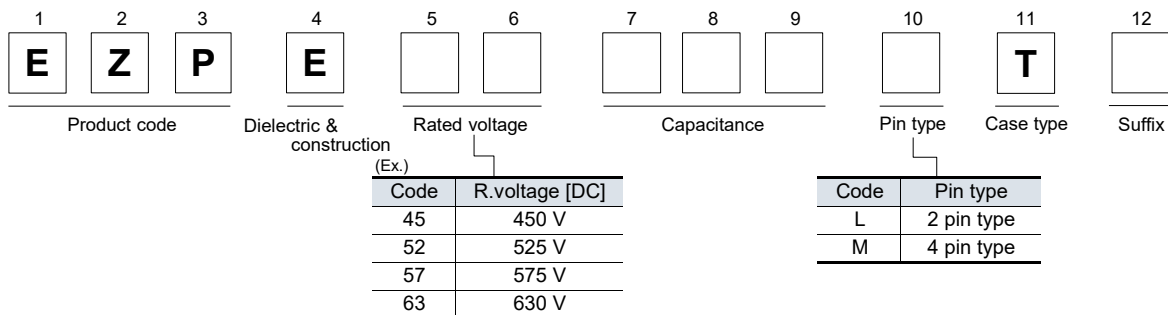

Specifications

Category temperature range ^{*1}	-40 °C to +85 °C	
Rated voltage ^{*2} [DC]	450 V, 525 V, 575 V, 630 V (Derating of rated voltage by more than 70 °C ^{*3})	
Rated capacitance	450 V	66 μF
	525 V	29 μF
	575 V	12 μF
	630 V	10 μF
Capacitance tolerance	±15 %	
Withstand voltage	Between terminals : Rated voltage (V) × 150 % 10 s	
	Terminal to case : 2000 V [AC] (50 Hz or 60 Hz), 10 s	
Insulation resistanc (IR)	CR ≥ 10,000 Ω·F (20 °C, 500 V [DC], 60 s)	

*1 : The temperature of capacitor surface (case)

*2 : Use for DC voltage only

*3 : Refer to the page of "DC voltage derating"

Dimensions

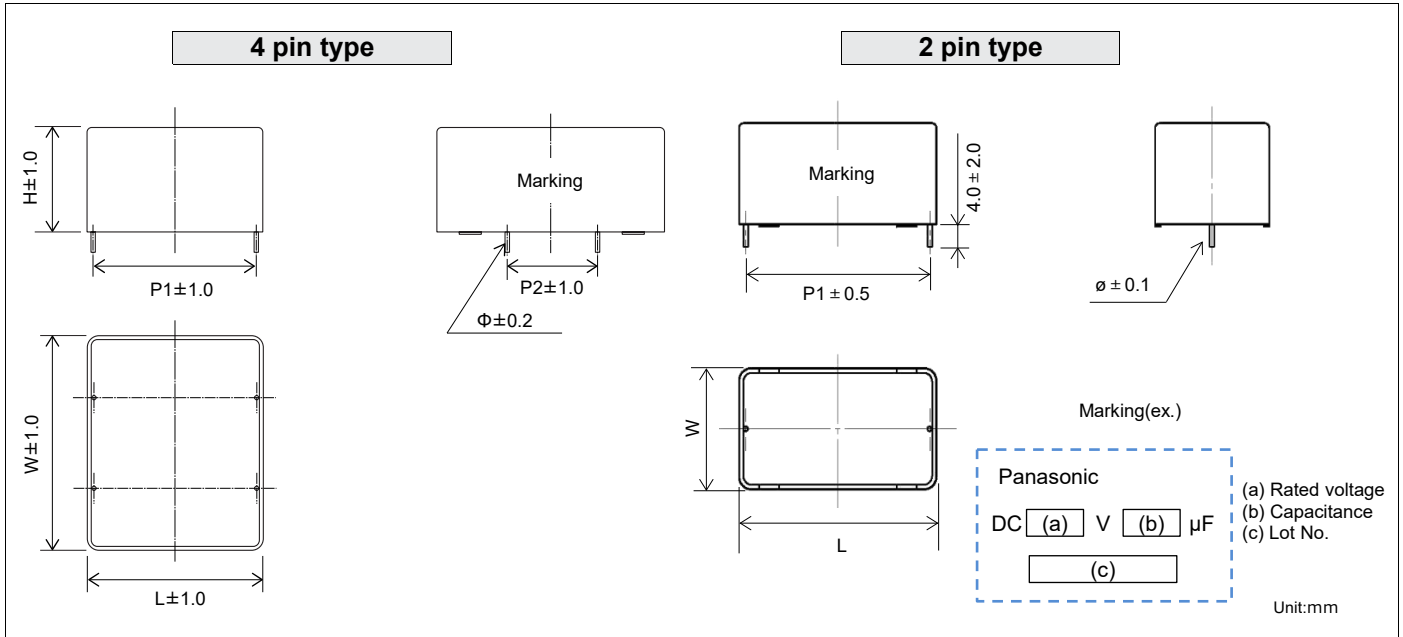

Rating · Dimensions · Quantity

■ Rated voltage [DC] : 450 V at 70 °C

Part No.	Capacitance (µF)	Dimensions (mm)						dv/dt [V/µs]	Permissible current		ESR ^{*3} (mΩ)	tan δ ^{*4} (%)	Mass (g)	Min. order Q'ty ^{*5} (PCS)
		W	H	L	P1	P2	ø		Peak current ^{*1} (A _{o-p})	RMS current ^{*2} (A rms)				
EZPE45666MTB	66	90.0	24.0	32.5	27.5	37.5	0.8	5	300	15.0	5.0	0.3	110	200

■ Rated voltage [DC] : 525 V at 70 °C

Part No.	Capacitance (µF)	Dimensions (mm)						dv/dt [V/µs]	Permissible current		ESR ^{*3} (mΩ)	tan δ ^{*4} (%)	Mass (g)	Min. order Q'ty ^{*5} (PCS)
		W	H	L	P1	P2	ø		Peak current ^{*1} (A _{o-p})	RMS current ^{*2} (A rms)				
EZPE52296MTB	29	48.5	23.5	37.0	34.0	20.3	0.8	14	400	3.0	7.0	0.4	50	400

■ Rated voltage [DC] : 575 V at 70 °C

Part No.	Capacitance (µF)	Dimensions (mm)						dv/dt [V/µs]	Permissible current		ESR ^{*3} (mΩ)	tan δ ^{*4} (%)	Mass (g)	Min. order Q'ty ^{*5} (PCS)
		W	H	L	P1	P2	ø		Peak current ^{*1} (A _{o-p})	RMS current ^{*2} (A rms)				
EZPE57126LTB	12	24.5	19.5	41.5	37.5	—	1.0	22	264	5.0	22.0	0.45	25	800

■ Rated voltage [DC] : 630 V at 70 °C

Part No.	Capacitance (µF)	Dimensions (mm)						dv/dt [V/µs]	Permissible current		ESR ^{*3} (mΩ)	tan δ ^{*4} (%)	Mass (g)	Min. order Q'ty ^{*5} (PCS)
		W	H	L	P1	P2	ø		Peak current ^{*1} (A _{o-p})	RMS current ^{*2} (A rms)				
EZPE63106LTB	10	24.5	19.5	41.5	37.5	—	1.0	21	210	3.0	22.0	0.45	25	800

*1 : When rising temperature of capacitor surface by continuous peak current (included pulse current), use within limit specified for temperature of capacitor surface and self heating temperature rise.

*2 : Maximum RMS current @70 °C, 10 kHz
Use within limit for self heating temperature rise at capacitor surface.

*3 : Typical values @ 20 °C, 10 kHz ESR : less than 2.5×ESR typ

*4 : Maximum dissipation factor @ 20 °C, 1 kHz

*5 : Minimum order quantity consists of 4 packing units.

Plastic Film Capacitors

Metalized Polypropylene Film Capacitor

EZPQ series



Features

- High safety (Self-protecting function built-in)
- Long product life, High reliability
- Low loss, Low ESR
- Flame retardant (Case and sealing resin)
- High moisture resistance (85 °C, 85 %RH)
 - 330 V : 280 V, 1000 h
 - 380 V : 320 V, 1000 h
 - 600 V : 540 V, 1000 h
- RoHS compliant

Recommended applications

For AC filter

- Solar inverters
- UPS
- Industrial power supplies
- Inverter circuit in appliances (Air conditioners etc.)

Construction

- Dielectric : Polypropylene film
- Electrodes : Metallized dielectric with segmented pattern
- Plastic case : UL94 V-0
- Sealing : UL94 V-0
- Terminals : Tinned wires, 2-pin and 4-pin versions

Explanation of part number

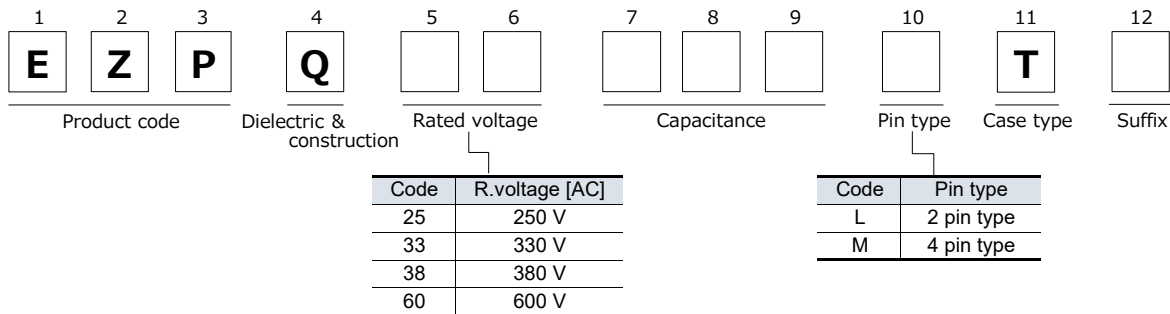

Specifications

Category temperature range ^{*1}	250 V	-40 °C to +85 °C
	330 V, 380 V 600 V	-40 °C to +105 °C
Rated voltage ^{*2} [AC]	250 V	250 V
	330 V, 380 V, 600 V	330 V, 380 V, 600 V (Derating of rated voltage by 1.0 %/°C at more than 85 °C)
Rated capacitance	250 V	12, 22, 36 μF
	330 V	3 μF to 35 μF
	380 V	1 μF to 33 μF
	600 V	1 μF to 12 μF
Capacitance tolerance		±5%, ±10 %
Withstand voltage	250 V	Between terminals : Rated voltage (V) × 175 % 10 s Terminal to case : 2000 V [AC] (50 Hz or 60 Hz), 10 s
	330 V, 380 V 600 V	Between terminals : Rated voltage (V) × 150 % 60 s Terminal to case : 2000 V [AC] (50 Hz or 60 Hz), 10 s
Insulation resistance (IR)		CR ≥ 10,000 Ω·F (20 °C, 100 V [DC], 60 s)

*1 : The temperature of capacitor surface (case).

*2 : Use for AC voltage only.

Note : Some part numbers of 600V products are not recommended for new design.

Dimensions

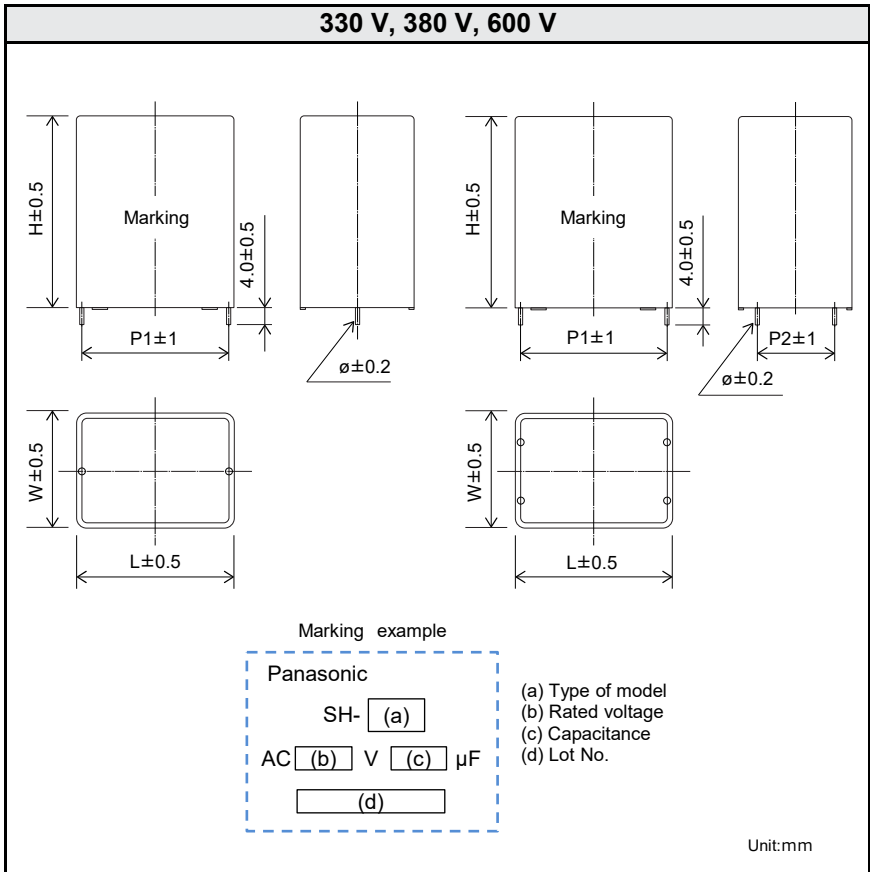
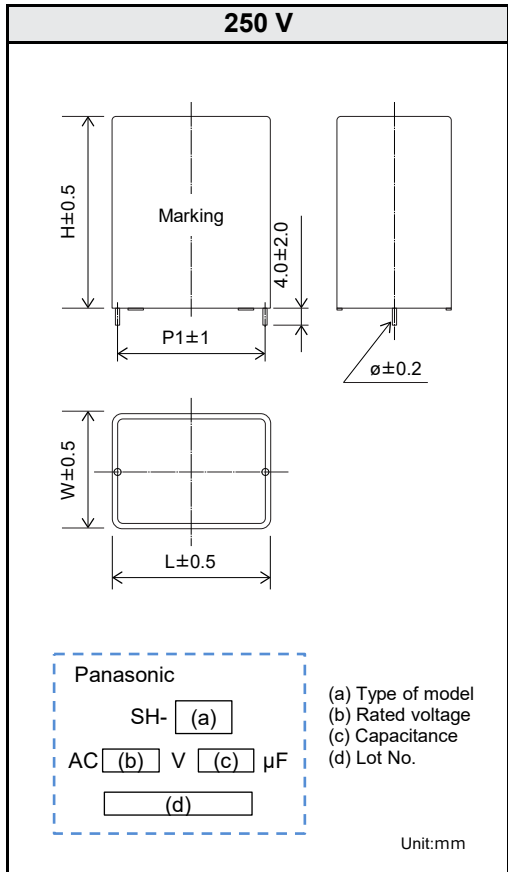

Rating · Dimensions · Quantity

■ Rated voltage [AC] : 250 V

Part No.	Capacitance (μF)	Dimensions (mm)						Mass (g)	Min. order Q'ty*1 (PCS)
		W	H	L	P1	P2	ø		
EZPQ25126LTA	12	22	36	48.5	45.6	—	1.2	80	800
EZPQ25226LTA	22	30	45	57.5	52.5	—	1.2	107	200
EZPQ25366LTA	36	35	56	57.5	52.5	—	1.2	136	200

*1 : Minimum order quantity consists of 4 packing units.

Rating · Dimensions · Quantity

■ Rated voltage [AC] : 330 V

Part No.	Cap. Tol. (%)	Cap. (μF)	Dimensions (mm)						dv/dt (V/μs)	Permissible current		ESR ^{*3} (mΩ)	Mass (g)	Min. order Qty ^{*4} (PCS)
			W	H	L	P1	P2	ø		Peak current ^{*1} (A _{0-P})	RMS current ^{*2} (A rms)			
EZPQ33305LTA	±5	3.0	17.0	34.5	41.5	37.5	-	1.0	23	69	5.0	23.0	29	1200
EZPQ33335LTA	±5	3.3	17.0	34.5	41.5	37.5	-	1.0	23	76	5.3	21.2	29	1200
EZPQ33355LTA	±5	3.5	17.0	34.5	41.5	37.5	-	1.0	23	81	5.6	20.0	29	1200
EZPQ33405LTA	±5	4.0	17.0	34.5	41.5	37.5	-	1.0	23	92	6.2	17.5	29	1200
EZPQ33455LTA	±5	4.5	17.0	34.5	41.5	37.5	-	1.0	23	104	6.8	15.9	29	1200
EZPQ33475LTA	±5	4.7	22.0	36.0	41.5	37.5	-	1.0	23	108	6.8	16.2	39	600
EZPQ33505LTA	±5	5.0	22.0	36.0	41.5	37.5	-	1.0	23	115	7.1	15.2	38	600
EZPQ33605LTA	±5	6.0	22.0	36.0	41.5	37.5	-	1.0	23	138	8.0	13.5	40	600
EZPQ33685LTA	±5	6.8	26.0	40.5	41.5	37.5	-	1.0	23	156	8.6	12.6	53	600
EZPQ33705LTA	±5	7.0	26.0	40.5	41.5	37.5	-	1.0	23	161	8.8	12.2	53	600
EZPQ33805LTA	±5	8.0	26.0	40.5	41.5	37.5	-	1.0	23	184	9.5	11.3	53	600
EZPQ33905LTA	±5	9.0	26.5	41.5	41.5	37.5	-	1.0	23	207	10.3	10.6	54	400
EZPQ33106LTB	±5	10.0	30.0	50.5	41.5	37.5	-	1.0	23	230	10.4	10.9	74	400
EZPQ33106LTC	±5	10.0	35.5	50.5	42.5	37.5	-	1.2	23	230	12.1	8.1	89	400
EZPQ33126LTA	±5	12.0	30.0	50.5	41.5	37.5	-	1.0	23	276	11.5	10.0	73	400
EZPQ33146LTA	±5	14.0	35.5	50.5	42.5	37.5	-	1.2	23	322	14.4	7.1	89	400
EZPQ33156LTA	±5	15.0	35.5	50.5	42.5	37.5	-	1.2	23	345	14.9	7.0	93	400
EZPQ33206LTB	±5	20.0	43.0	58.0	41.5	37.5	-	1.2	23	460	17.9	5.9	126	400
EZPQ33106MTA	±5	10.0	30.0	50.5	41.5	37.5	10.2	1.0	23	230	10.4	10.9	75	400
EZPQ33126MTA	±5	12.0	30.0	50.5	41.5	37.5	10.2	1.0	23	276	11.5	10.0	74	400
EZPQ33146MTA	±5	14.0	35.5	50.5	42.5	37.5	10.2	1.2	23	322	14.4	7.1	90	400
EZPQ33156MTA	±5	15.0	35.5	50.5	42.5	37.5	10.2	1.2	23	345	14.9	7.0	94	400
EZPQ33206MTA	±5	20.0	43.0	58.0	41.5	37.5	10.2	1.2	23	460	17.9	5.9	127	400
EZPQ33156LTB	±5	15.0	30.0	51.0	57.5	52.5	-	1.2	14	210	9.0	9.3	117	200
EZPQ33186MTA	±5	18.0	30.0	51.0	57.5	52.5	10.2	1.2	14	252	10.0	8.4	114	200
EZPQ33206MTB	±5	20.0	30.0	51.0	57.5	52.5	20.3	1.2	14	280	10.8	7.6	116	200
EZPQ33226MTA	±5	22.0	35.0	50.0	57.5	52.5	20.3	1.2	14	308	11.6	7.0	135	200
EZPQ33256MTB	±5	25.0	40.0	51.5	57.5	52.5	20.3	1.2	14	350	12.2	7.0	159	200
EZPQ33286MTA	±5	28.0	35.0	64.5	57.5	52.5	20.3	1.2	14	392	12.6	6.9	165	200
EZPQ33306MTB	±5	30.0	45.0	62.0	57.5	52.5	20.3	1.2	14	420	13.3	6.6	214	200
EZPQ33356MTA	±5	35.0	45.0	62.0	57.5	52.5	20.3	1.2	14	490	14.4	6.2	210	200

*1 : When rising temperature of capacitor surface by continuous peak current(included pulse current), use within limit specified for temperature of capacitor surface and self heating temperature rise.

*2 : Maximum RMS current @ 85°C , 10kHz Use within limit for self heating temperature rise at capacitor surface.

*3 : 20 °C, 10 kHz

*4 : Minimum order quantity consists of 4 packing units.

Rating · Dimensions · Quantity

■ Rated voltage [AC] : 380 V

Part No.	Cap. Tol. (%)	Cap. (μF)	Dimensions (mm)						dv/dt (V/μs)	Permissible current		ESR ^{*3} (mΩ)	Mass (g)	Min. order Qty ^{*4} (PCS)
			W	H	L	P1	P2	ø		Peak current ¹ (A _{0-P})	RMS current ² (A rms)			
EZPQ38105LTA	±5	1.0	15.0	29.0	41.5	37.5	-	1.0	50	50	2.1	71.6	22	1200
EZPQ38155LTA	±5	1.5	15.0	29.0	41.5	37.5	-	1.0	50	75	2.8	48.8	22	1200
EZPQ38205LTA	±5	2.0	15.0	29.0	41.5	37.5	-	1.0	50	100	3.5	36.6	22	1200
EZPQ38225LTB	±5	2.2	15.0	29.0	41.5	37.5	-	1.0	50	110	3.8	33.2	22	1200
EZPQ38255LTB	±5	2.5	15.0	29.0	41.5	37.5	-	1.0	50	125	4.1	29.2	22	1200
EZPQ38305LTA	±5	3.0	17.0	34.5	41.5	37.5	-	1.0	50	150	4.8	24.4	29	1200
EZPQ38335LTA	±5	3.3	17.0	34.5	41.5	37.5	-	1.0	50	165	5.2	22.1	29	1200
EZPQ38355LTA	±5	3.5	17.0	34.5	41.5	37.5	-	1.0	50	175	5.4	20.9	29	1200
EZPQ38405LTA	±5	4.0	22.0	36.0	41.5	37.5	-	1.0	50	200	6.0	18.3	39	600
EZPQ38455LTA	±5	4.5	22.0	36.0	41.5	37.5	-	1.0	50	225	6.5	16.7	39	600
EZPQ38475LTA	±5	4.7	22.0	36.0	41.5	37.5	-	1.0	50	235	6.7	16.0	39	600
EZPQ38505LTA	±5	5.0	22.0	36.0	41.5	37.5	-	1.0	50	250	7.1	15.1	40	600
EZPQ38555LTA	±5	5.5	26.0	40.5	41.5	37.5	-	1.0	50	275	7.4	14.4	53	600
EZPQ38605LTA	±5	6.0	26.0	40.5	41.5	37.5	-	1.0	50	300	7.8	13.7	53	600
EZPQ38705LTA	±5	7.0	26.0	40.5	41.5	37.5	-	1.0	50	350	8.7	12.2	53	600
EZPQ38755LTA	±5	7.5	26.5	41.5	41.5	37.5	-	1.0	50	375	9.1	11.8	54	400
EZPQ38805LTC	±10	8.0	26.5	41.5	41.5	37.5	-	1.0	70	560	10.0	11.9	55	400
EZPQ38805LTD	±5	8.0	27.5	42.0	41.5	37.5	-	1.0	50	400	9.2	11.9	56	600
EZPQ38855LTA	±5	8.5	30.0	50.5	41.5	37.5	-	1.0	50	425	9.5	11.7	74	400
EZPQ38905LTA	±5	9.0	30.0	50.5	41.5	37.5	-	1.0	50	450	9.8	11.4	74	400
EZPQ38955LTA	±5	9.5	30.0	50.5	41.5	37.5	-	1.0	50	475	10.1	11.0	74	400
EZPQ38106LTA	±5	10.0	30.0	50.5	41.5	37.5	-	1.0	50	500	10.4	10.8	73	400
EZPQ38126LTA	±5	12.0	30.0	56.0	41.5	37.5	-	1.2	50	600	12.7	8.0	83	400
EZPQ38156LTA	±5	15.0	38.0	57.5	41.5	37.5	-	1.2	50	750	14.6	7.1	108	400
EZPQ38805MTA	±5	8.0	27.5	42.0	41.5	37.5	10.2	1.0	50	400	9.2	11.9	57	600
EZPQ38855MTA	±5	8.5	30.0	50.5	41.5	37.5	10.2	1.0	50	425	9.5	11.7	75	400
EZPQ38905MTA	±5	9.0	30.0	50.5	41.5	37.5	10.2	1.0	50	450	9.8	11.4	75	400
EZPQ38955MTA	±5	9.5	30.0	50.5	41.5	37.5	10.2	1.0	50	475	10.1	11.0	75	400
EZPQ38106MTA	±5	10.0	30.0	50.5	41.5	37.5	10.2	1.0	50	500	10.4	10.8	74	400
EZPQ38126MTA	±5	12.0	30.0	56.0	41.5	37.5	10.2	1.2	50	600	12.7	8.0	84	400
EZPQ38156MTB	±5	15.0	38.0	57.5	41.5	37.5	10.2	1.2	50	750	14.6	7.1	109	400
EZPQ38106LTB	±5	10.0	25.0	40.0	57.5	52.5	-	1.2	30	300	7.1	13.3	75	600
EZPQ38116LTA	±5	11.0	30.0	51.0	57.5	52.5	-	1.2	30	330	7.6	12.2	120	200
EZPQ38126LTB	±5	12.0	30.0	51.0	57.5	52.5	-	1.2	30	360	8.1	11.4	119	200
EZPQ38156LTB	±5	15.0	30.0	51.0	57.5	52.5	-	1.2	30	450	9.5	9.3	114	200
EZPQ38156MTC	±5	15.0	30.0	51.0	57.5	52.5	10.2	1.2	30	450	9.5	9.3	115	200
EZPQ38166MTA	±5	16.0	30.0	51.0	57.5	52.5	10.2	1.2	30	480	9.9	8.9	115	200
EZPQ38186MTA	±5	18.0	30.0	51.0	57.5	52.5	10.2	1.2	30	540	10.8	8.1	115	200
EZPQ38206MTA	±5	20.0	35.0	50.0	57.5	52.5	20.3	1.2	30	600	11.7	7.5	133	200
EZPQ38226MTA	±5	22.0	35.0	56.0	57.5	52.5	20.3	1.2	30	660	11.9	7.5	147	200
EZPQ38246MTC	±5	24.0	35.0	64.5	57.5	52.5	20.3	1.2	30	720	12.2	7.6	166	200
EZPQ38306MTA	±5	30.0	45.0	62.0	57.5	52.5	20.3	1.2	30	900	14.2	6.6	211	200
EZPQ38336MTA	±5	33.0	45.0	62.0	57.5	52.5	20.3	1.2	30	990	15.0	6.2	206	200

*1 : When rising temperature of capacitor surface by continuous peak current(included pulse current), use within limit specified for temperature of capacitor surface and self heating temperature rise.

*2 : Maximum RMS current @ 85°C , 10kHz Use within limit for self heating temperature rise at capacitor surface.

*3 : 20 °C, 10 kHz

*4 : Minimum order quantity consists of 4 packing units.

Rating · Dimensions · Quantity

■ Rated voltage [AC] : 600 V

NEW

Part No.	Cap. Tol. (%)	Cap. (μF)	Dimensions (mm)						dv/dt (V/μs)	Permissible current		ESR ^{*3} (mΩ)	Mass (g)	Min. order Qty ^{*4} (PCS)
			W	H	L	P1	P2	∅		Peak current ^{*1} (A _{0-P})	RMS current ^{*2} (A rms)			
EZPQ60105LTD	±10	1.0	15.0	29.0	41.5	37.5	-	1.0	110	110	6.5	13.7	25	1200
EZPQ60155LTD	±10	1.5	17.0	34.5	41.5	37.5	-	1.0	110	165	7.9	11.2	34	1200
EZPQ60225LTD	±10	2.2	26.0	40.5	41.5	37.5	-	1.0	110	242	9.6	8.8	61	600
EZPQ60335MTD	±10	3.3	27.5	42.0	41.5	37.5	10.2	1.0	110	363	11.8	5.7	64	600
EZPQ60475MTD	±10	4.7	35.5	50.5	42.5	37.5	10.2	1.2	110	517	14.0	3.8	104	400
EZPQ60475MTE	±10	4.7	30.0	51.0	57.5	52.5	10.2	1.2	70	329	10.6	7.0	124	200
EZPQ60685MTD	±10	6.8	30.0	51.0	57.5	52.5	20.3	1.2	70	476	12.8	5.9	120	200
EZPQ60705MTD	±10	7.0	30.0	51.0	57.5	52.5	20.3	1.2	70	490	13.0	5.6	119	200
EZPQ60106MTD	±10	10.0	35.0	64.5	57.5	52.5	20.3	1.2	70	700	15.5	4.6	166	200
EZPQ60126MTD	±10	12.0	45.0	62.0	57.5	52.5	20.3	1.2	70	840	17.0	3.9	215	200

■ Rated voltage [AC] : 600 V

Not Recommended for New Design

Part No.	Cap. Tol. (%)	Cap. (μF)	Dimensions (mm)						dv/dt (V/μs)	Permissible current		ESR ^{*3} (mΩ)	Mass (g)	Min. order Qty ^{*4} (PCS)
			W	H	L	P1	P2	∅		Peak current ^{*1} (A _{0-P})	RMS current ^{*2} (A rms)			
EZPQ60105LTA	±10	1.0	15.0	29.0	41.5	37.5	-	1.0	110	110	6.5	26.6	25	1200
EZPQ60155LTA	±10	1.5	17.0	34.5	41.5	37.5	-	1.0	110	165	7.9	18.7	34	1200
EZPQ60225LTA	±10	2.2	26.0	40.5	41.5	37.5	-	1.0	110	242	9.6	13.3	61	600
EZPQ60335MTB	±10	3.3	27.5	42.0	41.5	37.5	10.2	1.0	110	363	11.8	9.4	64	600
EZPQ60475MTA	±10	4.7	35.5	50.5	42.5	37.5	10.2	1.2	110	517	14.0	7.0	104	400
EZPQ60475MTB	±10	4.7	30.0	51.0	57.5	52.5	10.2	1.2	70	329	10.6	7.3	124	200
EZPQ60685MTA	±10	6.8	30.0	51.0	57.5	52.5	20.3	1.2	70	476	12.8	5.9	120	200
EZPQ60705MTA	±10	7.0	30.0	51.0	57.5	52.5	20.3	1.2	70	490	13.0	5.6	119	200
EZPQ60106MTA	±10	10.0	35.0	64.5	57.5	52.5	20.3	1.2	70	700	15.5	4.7	166	200
EZPQ60126MTA	±10	12.0	45.0	62.0	57.5	52.5	20.3	1.2	70	840	17.0	4.3	215	200

*1 : When rising temperature of capacitor surface by continuous peak current(included pulse current), use within limit specified for temperature of capacitor surface and self heating temperature rise.

*2 : Maximum RMS current @ 85°C , 10kHz Use within limit for self heating temperature rise at capacitor surface.

*3 : 20 °C, 10 kHz

*4 : Minimum order quantity consists of 4 packing units.

Characteristics data

■ **Rated voltage [AC] : 330 V (Lead pitch 37.5 mm)**

Electrical characteristics <Typical data >

Temperature characteristics

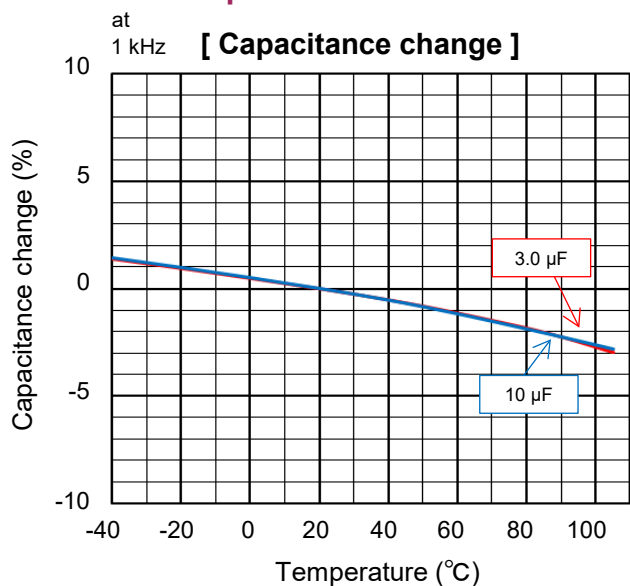

Frequency characteristics

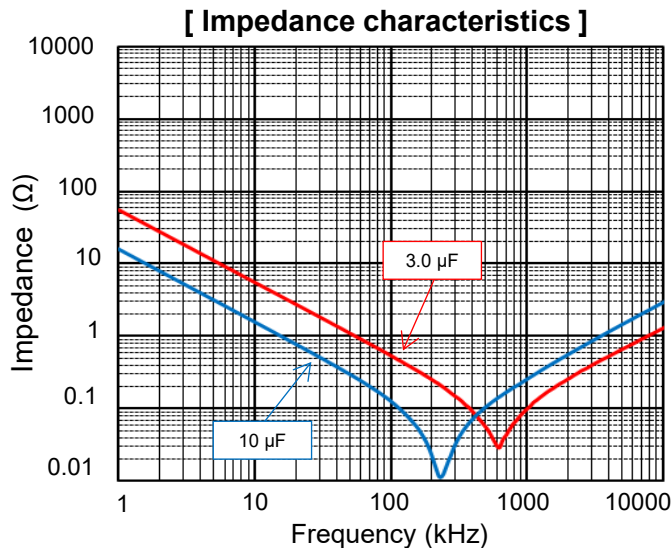

at 1 kHz [Dissipation factor]

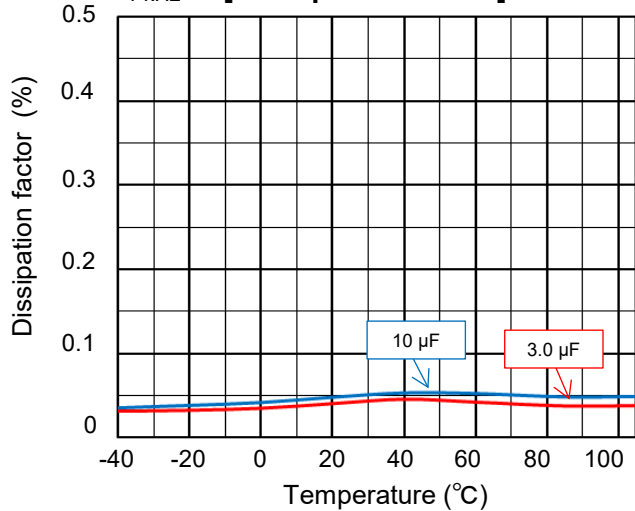

at DC 100 V [Insulation resistance]

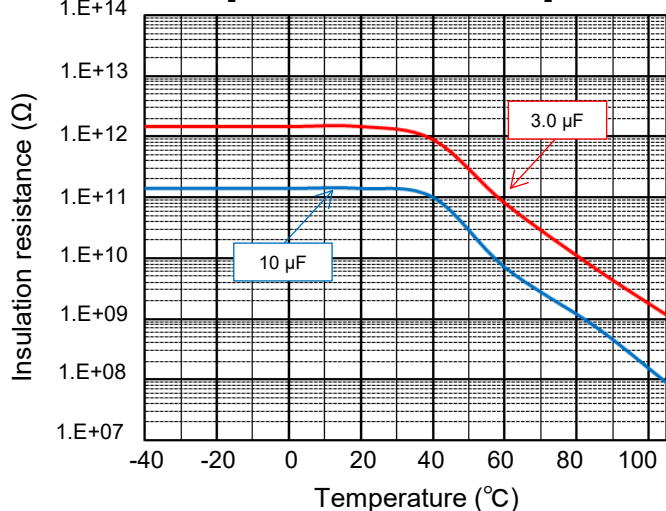

Characteristics data

■ **Rated voltage [AC] : 330 V (Lead pitch 37.5 mm)**

Applicable specifications

[Permissible Current]

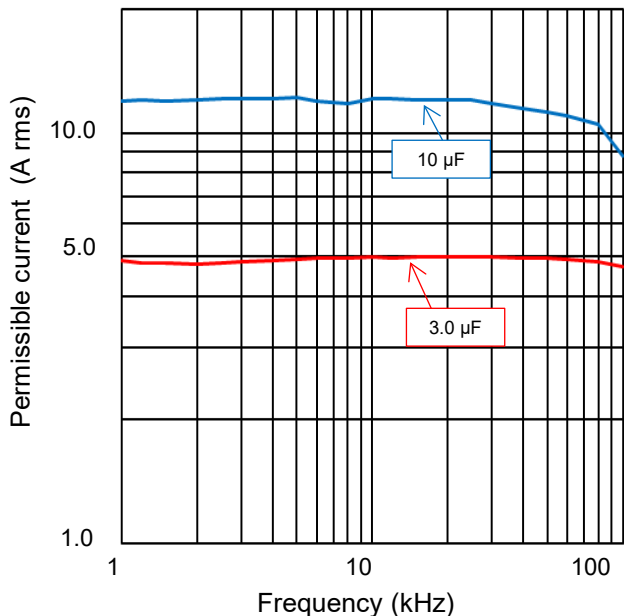

[Permissible Current Derating by Temperature]

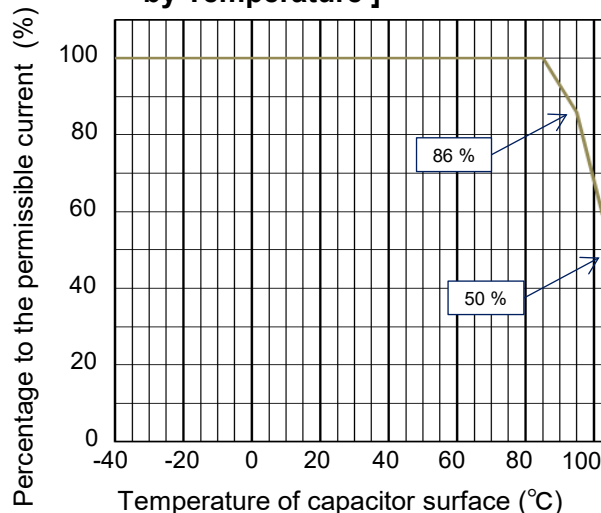

[Voltage Derating by Temperature]

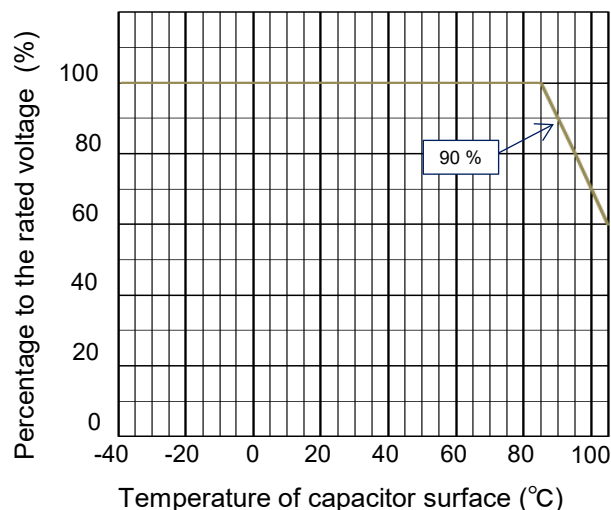

[Lifetime expectancy]

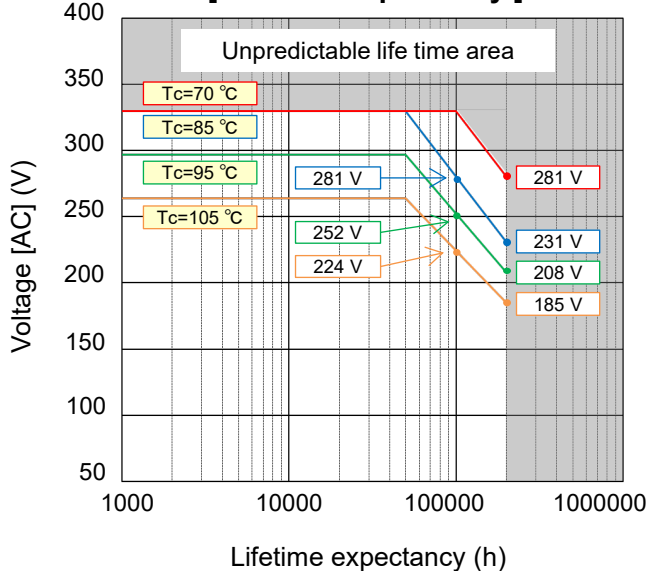

**Permissible pulse current (dV/dt)
(Max. 10000 cycles)**

R. voltage [AC] (V)	Pitch (mm)	Capacitance (µF)	Code	dV/dt (V/µs)	Current (A _{o-p})
330	37.5	3.0	305	23	69.0
		5.0	505		115.0
		6.0	605		138.0
		8.0	805		184.0
		10.0	106		230.0
		15.0	156		345.0
		20.0	206		460.0

[Self Heating Derating by Temperature]

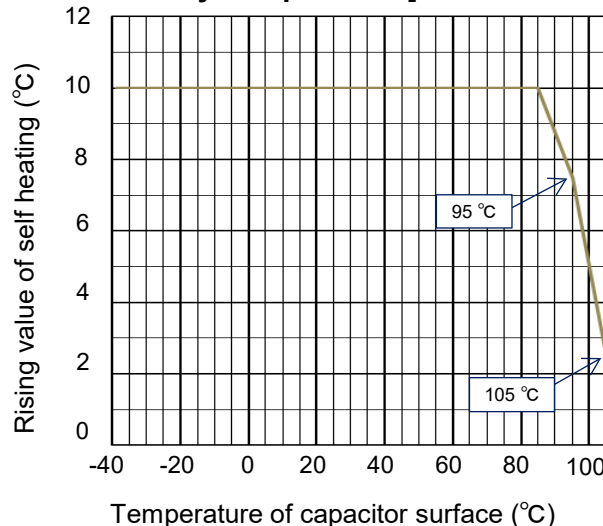

Characteristics data

■ **Rated voltage [AC] : 330 V (Lead pitch 52.5 mm)**

Electrical characteristics <Typical data >

Temperature characteristics

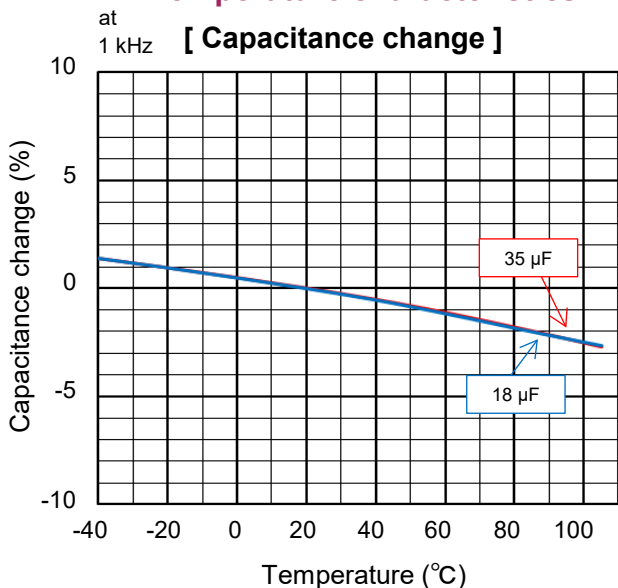

Frequency characteristics

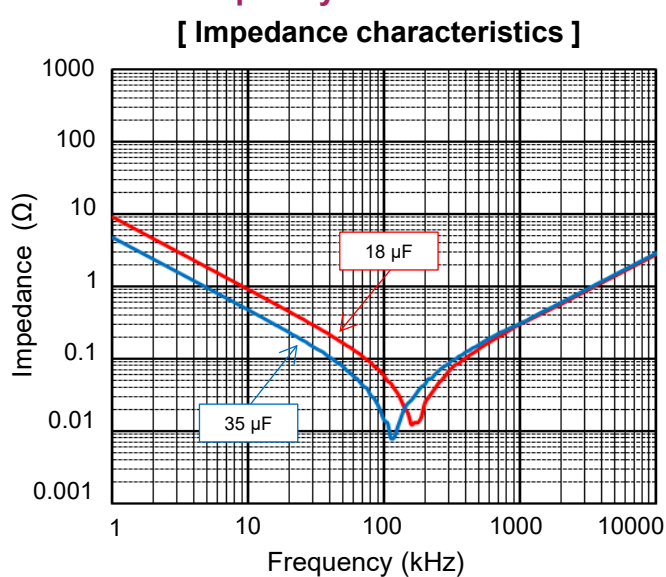

at 1 kHz [**Dissipation factor**]

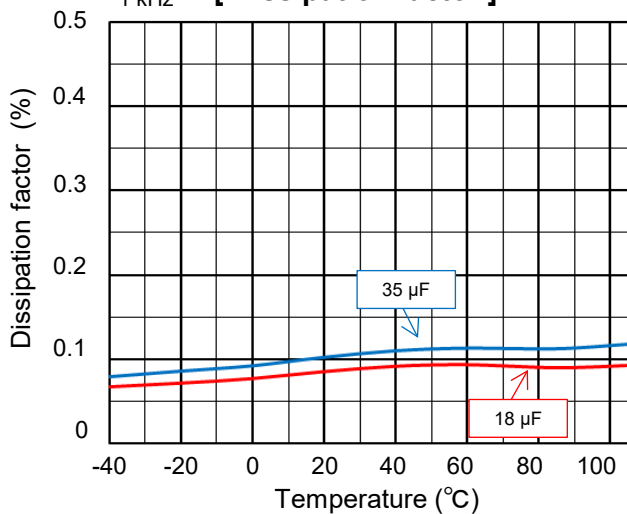

at DC 100 V [**Insulation resistance**]

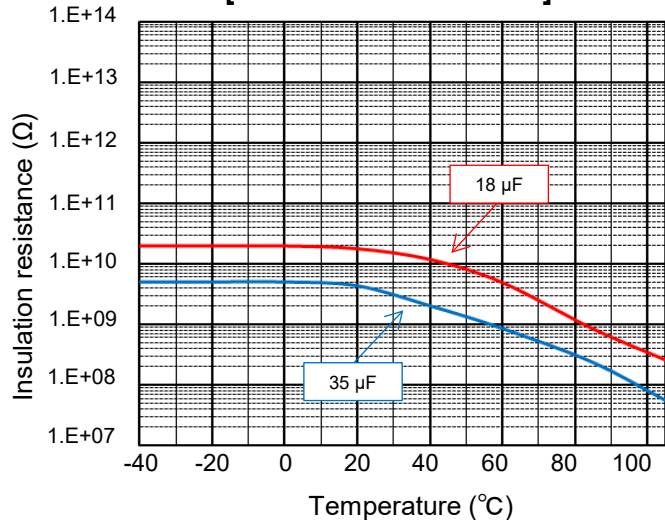

Characteristics data

■ **Rated voltage [AC] : 330 V (Lead pitch 52.5 mm)**

Applicable specifications

[Permissible Current]

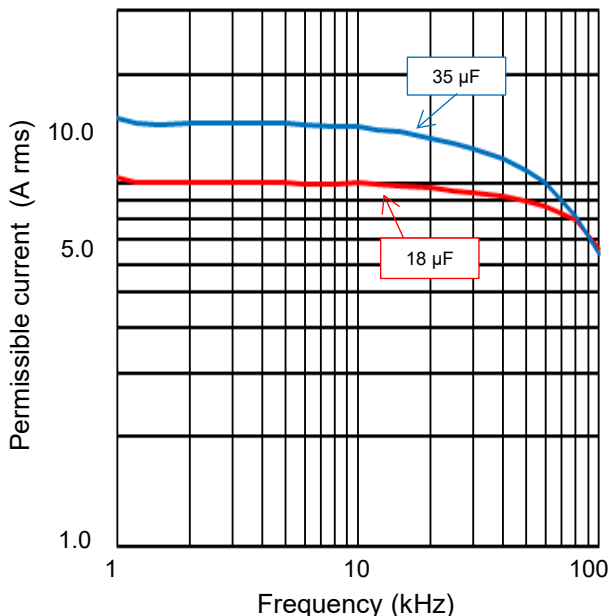

[Permissible Current Derating by Temperature]

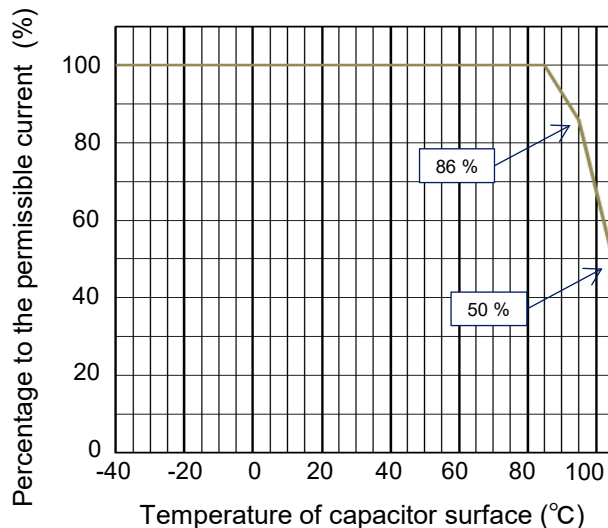

[Lifetime expectancy]

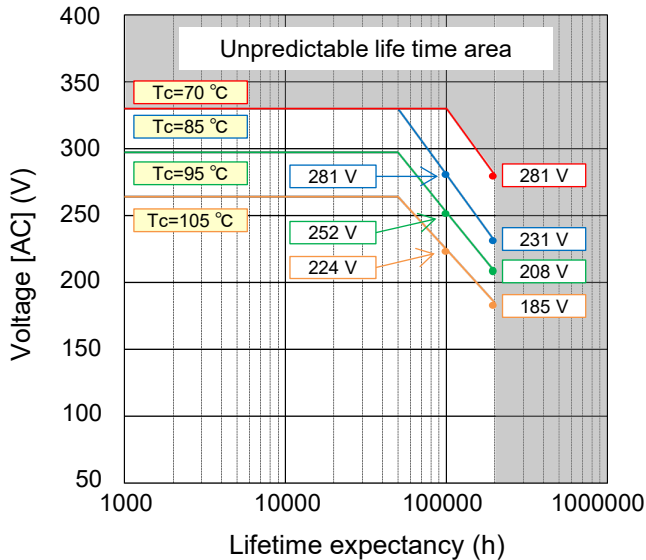

[Voltage Derating by Temperature]

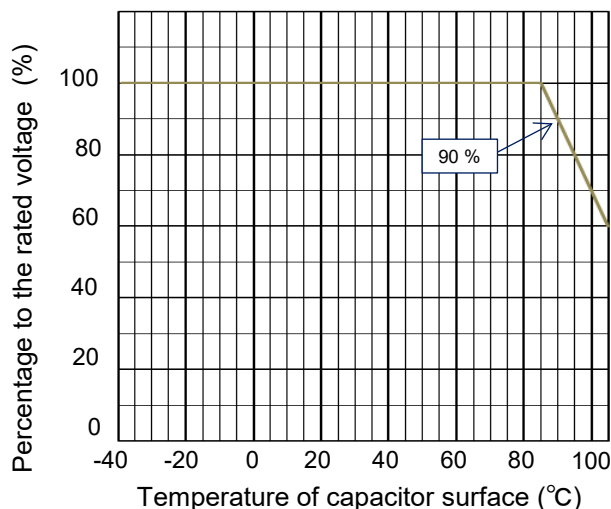

**Permissible pulse current (dV/dt)
(Max. 10000 cycles)**

R. voltage [AC] (V)	Pitch (mm)	Capacitance (µF)	Code	dV/dt (V/µs)	Current (A _{o-p})
330	52.5	15.0	156	14	210.0
		18.0	186		252.0
		20.0	206		280.0
		22.0	226		308.0
		25.0	256		350.0
		30.0	306		420.0
		35.0	356		490.0

[Self Heating Derating by Temperature]

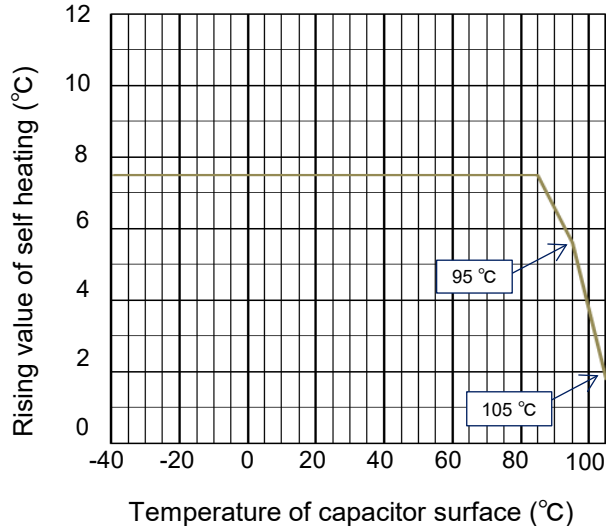

Characteristics data

■ **Rated voltage [AC] : 380 V (Lead pitch 37.5 mm)**

Electrical characteristics <Typical data >

Temperature characteristics

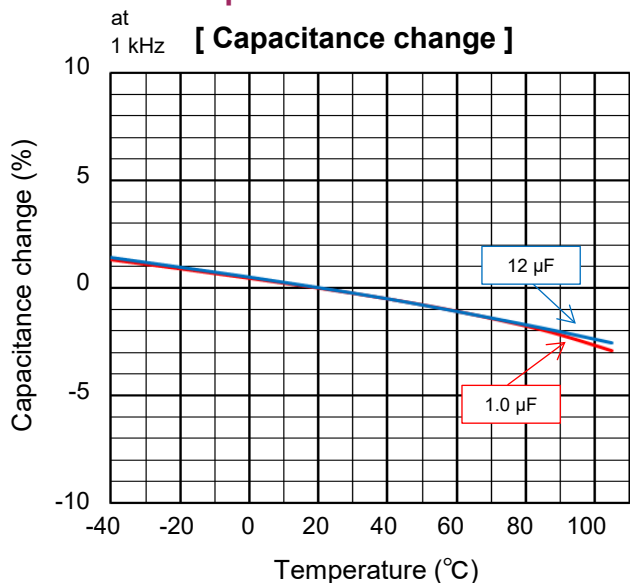

Frequency characteristics

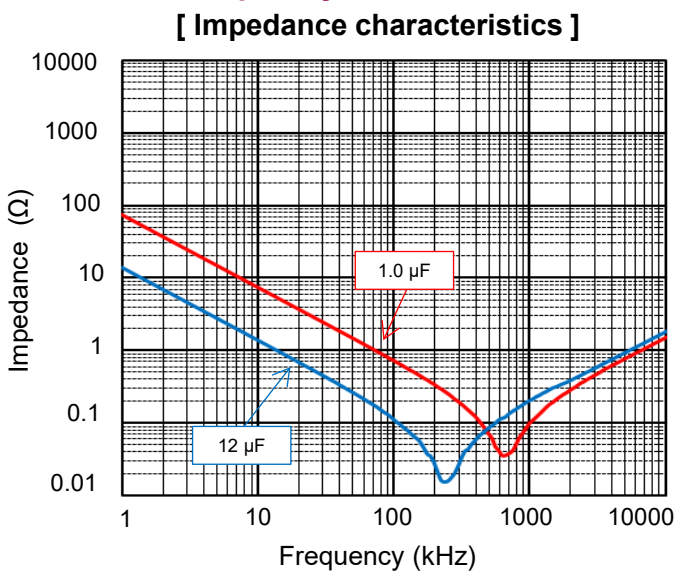

at 1 kHz [**Dissipation factor**]

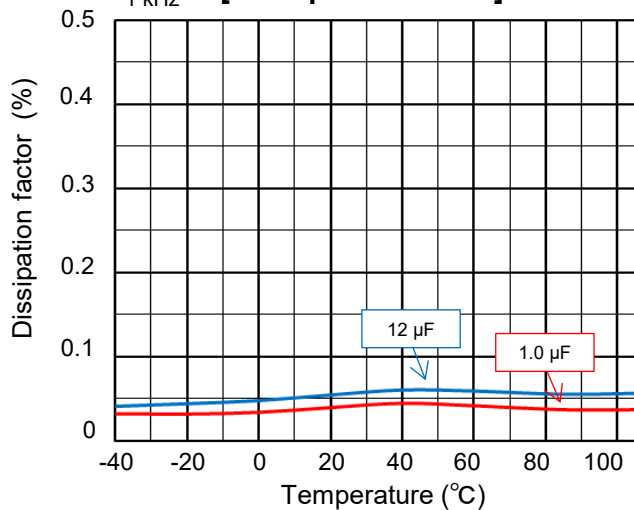

at DC 100 V [**Insulation resistance**]

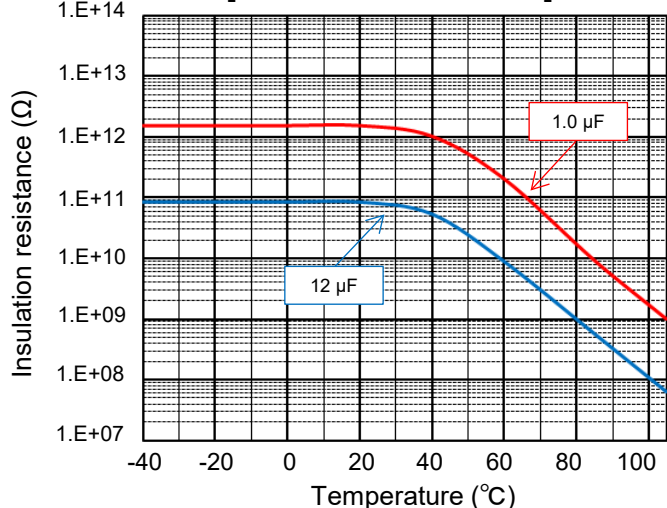

Characteristics data

■ **Rated voltage [AC] : 380 V (Lead pitch 37.5 mm)**

Applicable specifications

[Permissible Current]

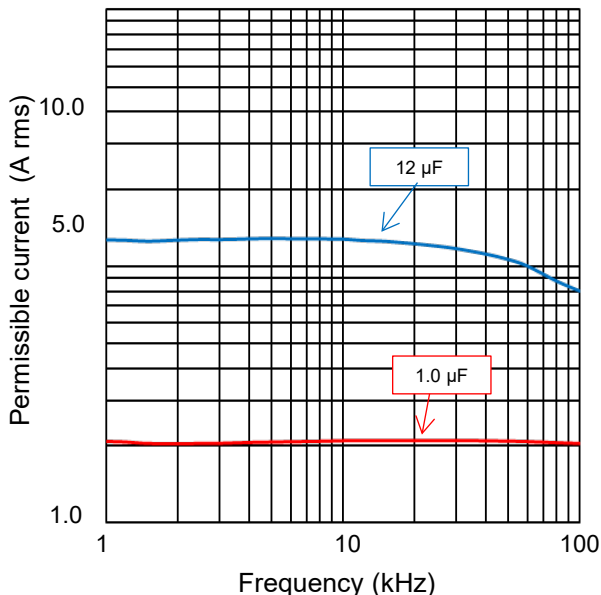

[Permissible Current Derating by Temperature]

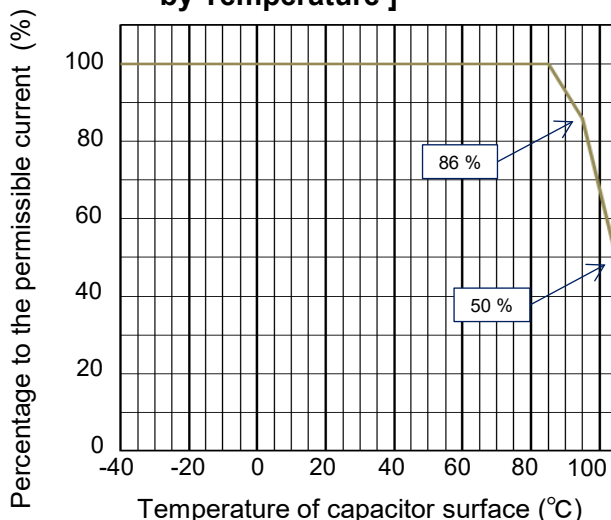

[Voltage Derating by Temperature]

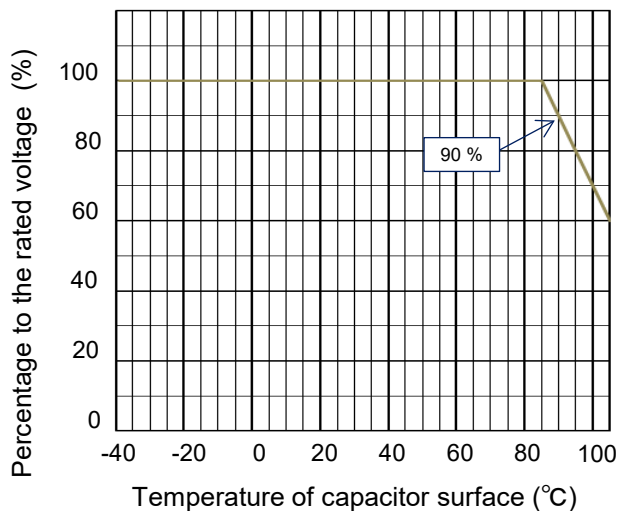

[Lifetime expectancy]

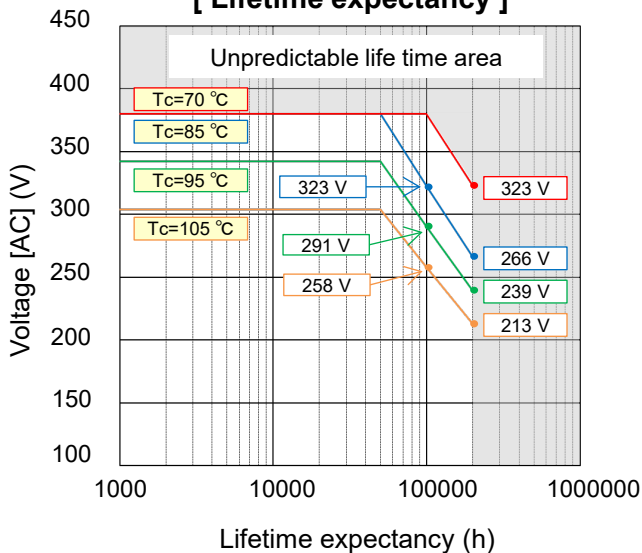

[Self Heating Derating by Temperature]

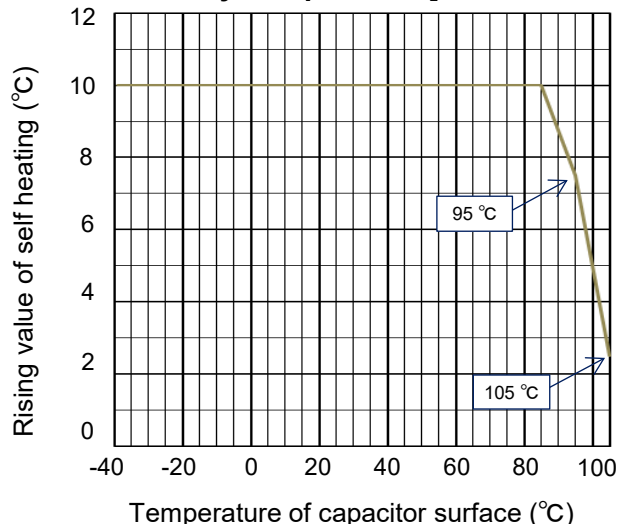

Permissible pulse current (dV/dt)
(Max. 10000 cycles)

R. voltage [AC] (V)	Pitch (mm)	Capacitance (μF)	Code	dV/dt (V/μs)	Current (A _{o-p})
380	37.5	1.0	105	50	50.0
		3.0	305		150.0
		5.0	505		250.0
		6.0	605		300.0
		8.0	805		400.0
		10.0	106		500.0
		15.0	156		750.0

Characteristics data

■ **Rated voltage [AC] : 380 V (Lead pitch 52.5 mm)**

Electrical characteristics <Typical data >

Temperature characteristics

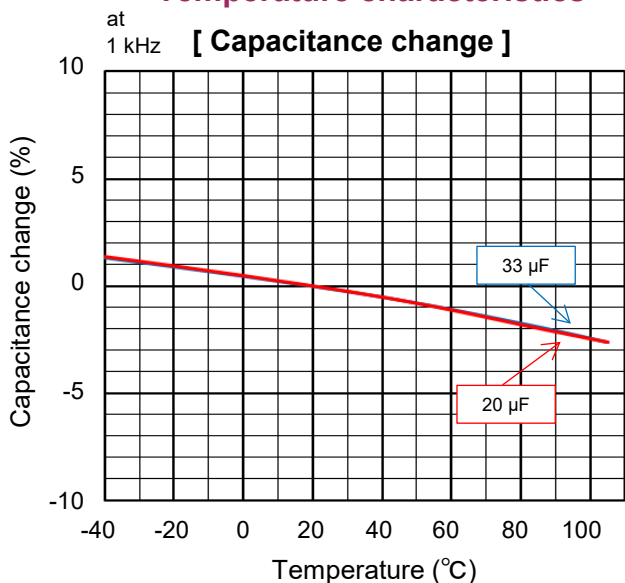

Frequency characteristics

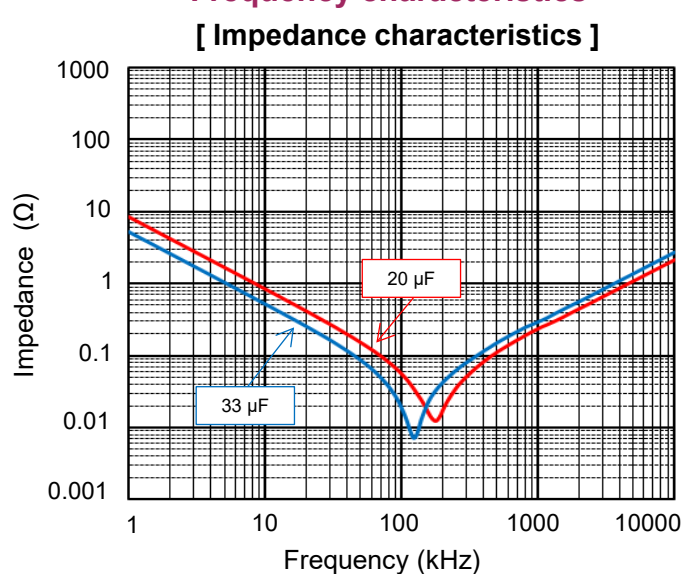

at 1 kHz [**Dissipation factor**]

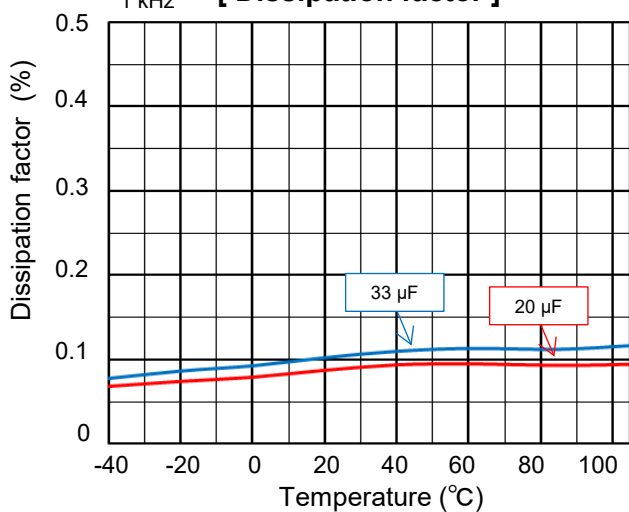

at DC 100 V [**Insulation resistance**]

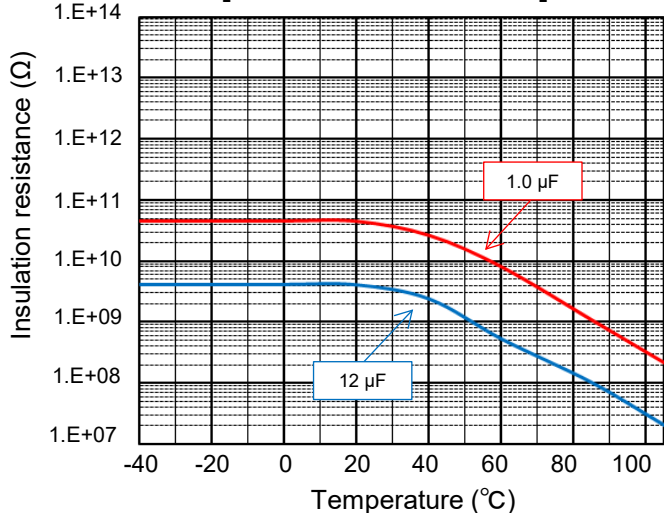

Characteristics data

■ **Rated voltage [AC] : 380 V (Lead pitch 52.5 mm)**

Applicable specifications

[Permissible Current]

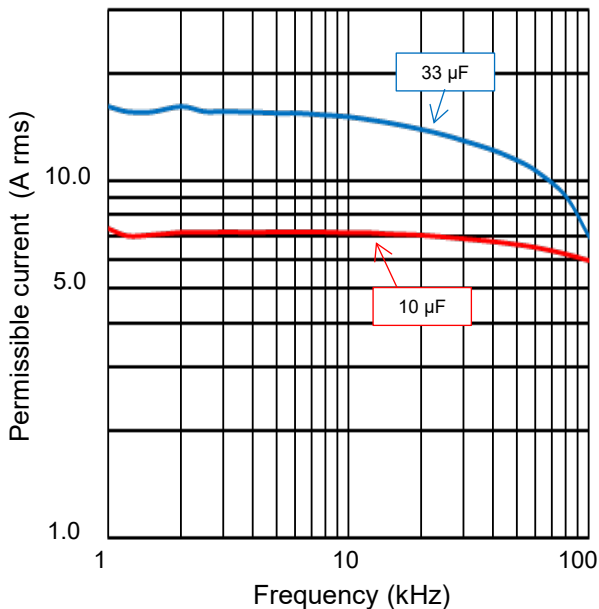

[Permissible Current Derating by Temperature]

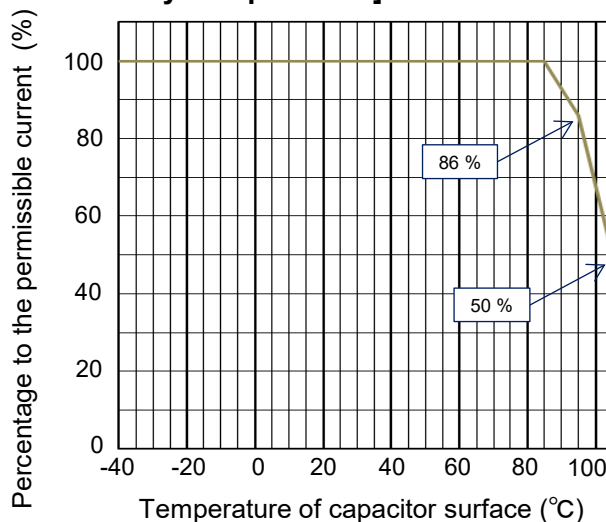

[Lifetime expectancy]

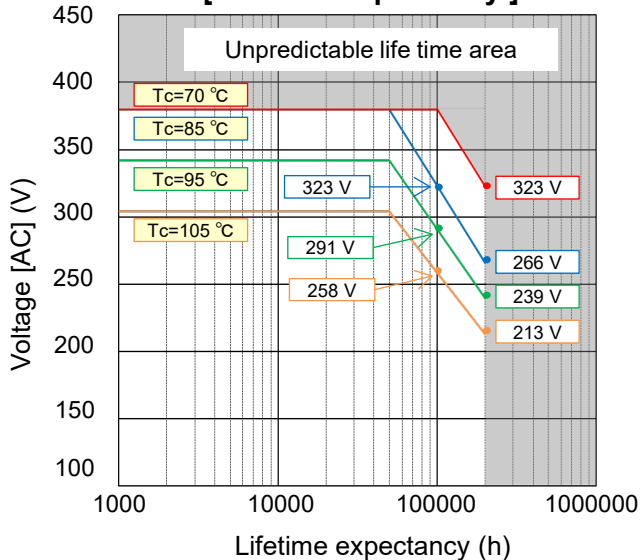

[Voltage Derating by Temperature]

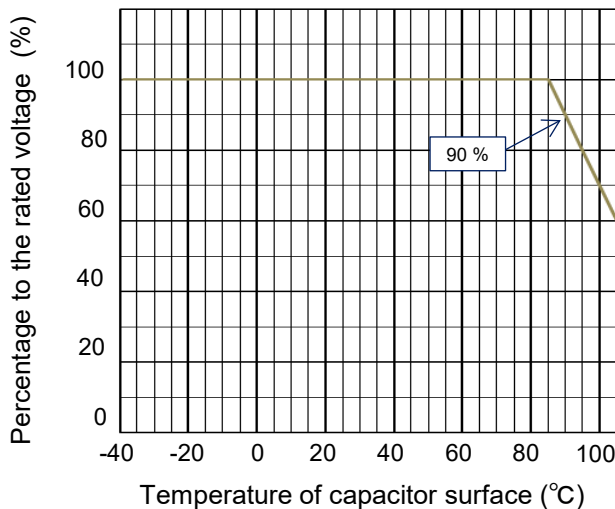

**Permissible pulse current (dV/dt)
(Max. 10000 cycles)**

R. voltage [AC] (V)	Pitch (mm)	Capacitance (μF)	Code	dV/dt (V/μs)	Current (A _{o-p})
380	52.5	10.0	106	30	300.0
		12.0	126		360.0
		15.0	156		450.0
		20.0	206		600.0
		24.0	246		720.0
		30.0	306		900.0
		33.0	336		990.0

[Self Heating Derating by Temperature]

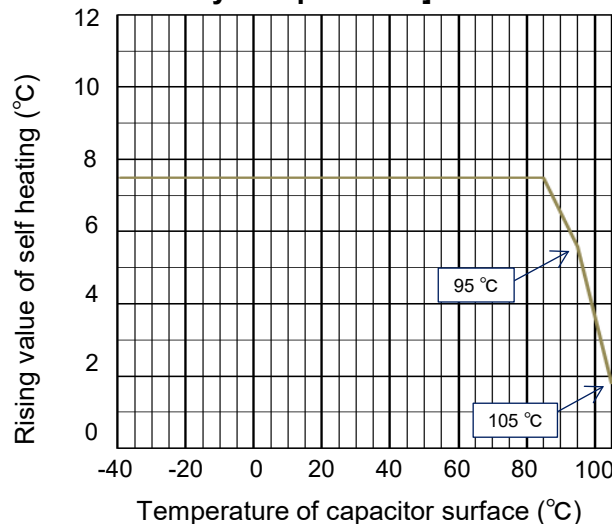

Characteristics data

■ **Rated voltage [AC] : 600 V (Lead pitch 37.5 mm)**

Electrical characteristics <Typical data >

Temperature characteristics

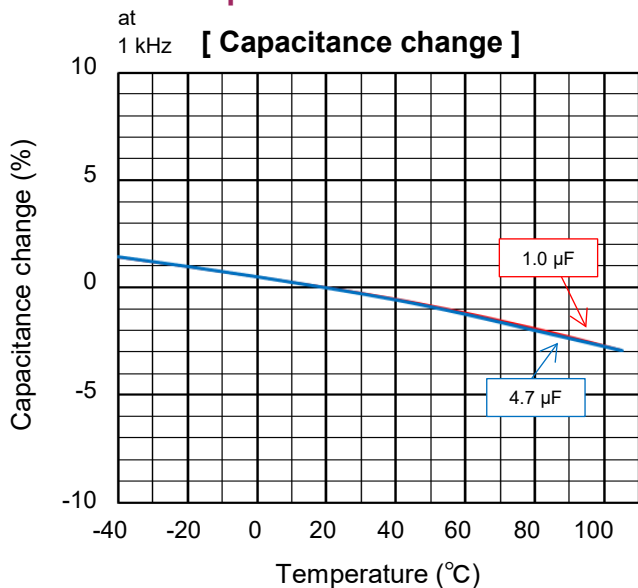

Frequency characteristics

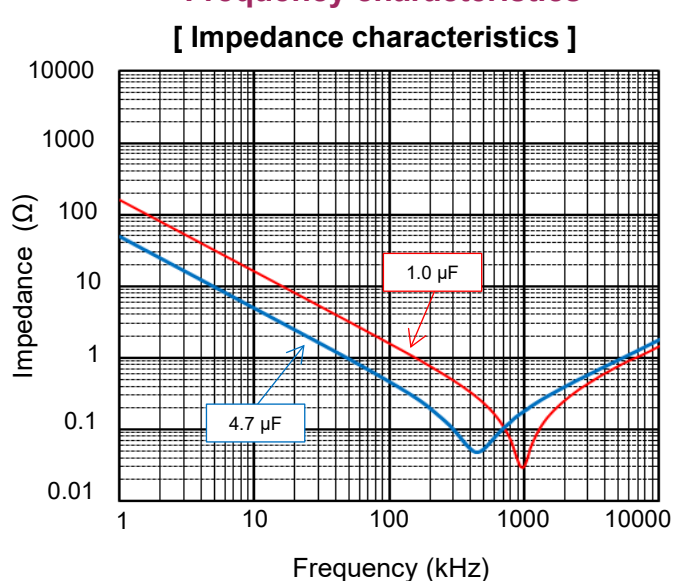

at 1 kHz [**Dissipation factor**]

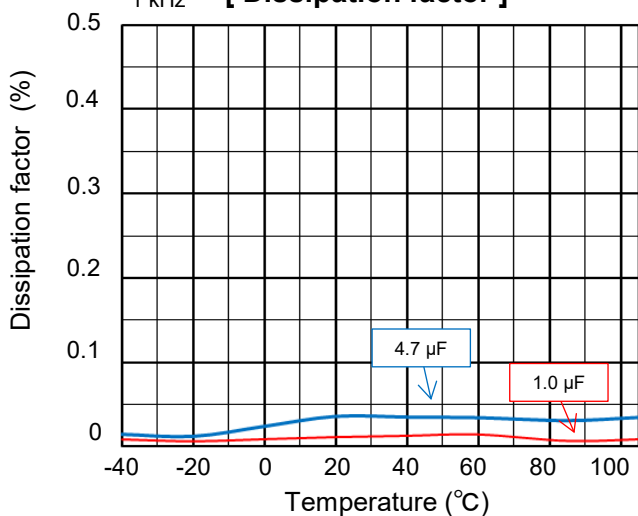

at DC 100 V [**Insulation resistance**]

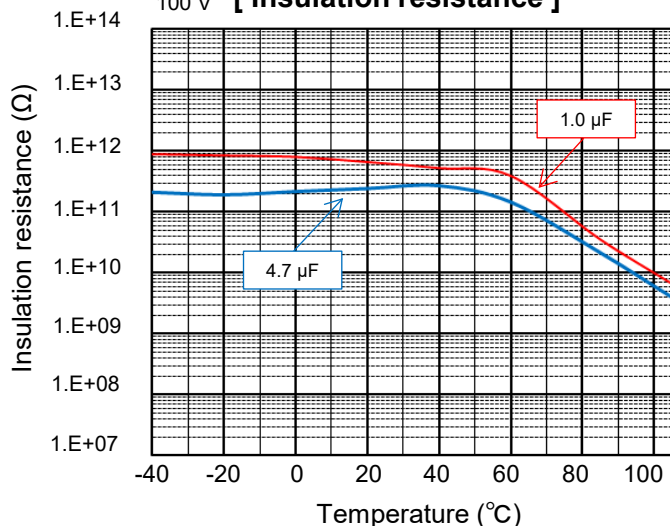

Characteristics data

■ **Rated voltage [AC] : 600 V (Lead pitch 37.5 mm)**

Applicable specifications

[Permissible Current]

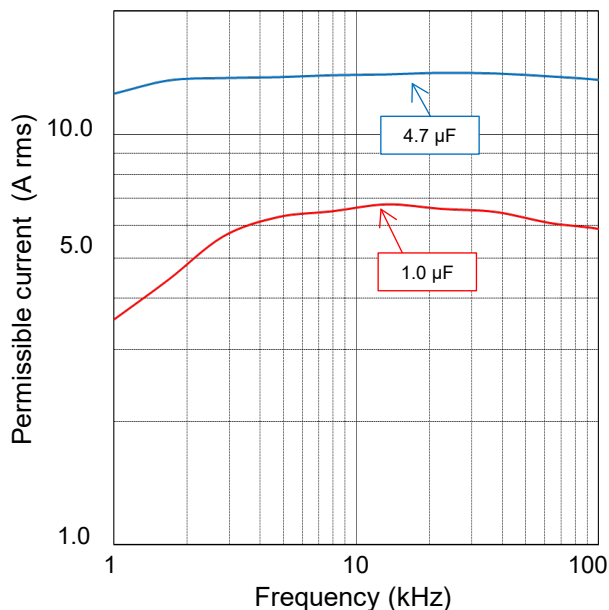

[Permissible Current Derating by Temperature]

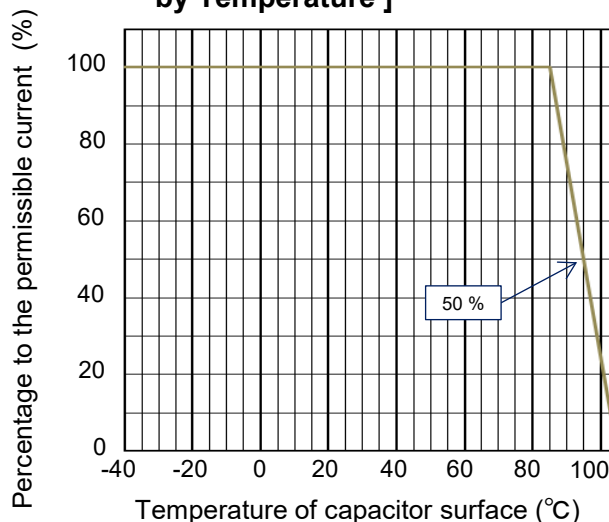

[Voltage Derating by Temperature]

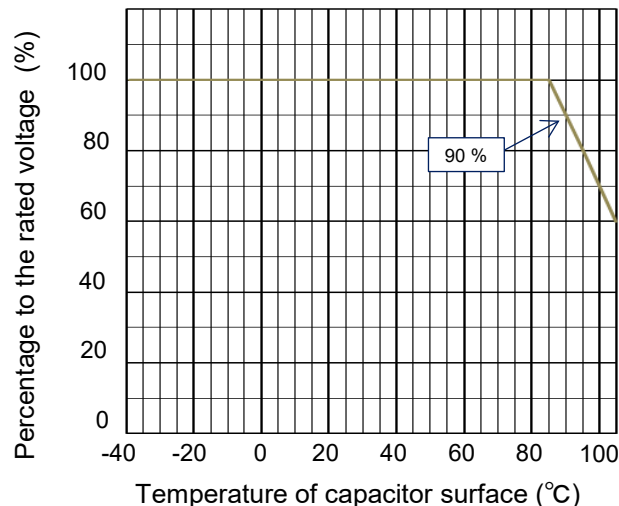

[Lifetime expectancy]

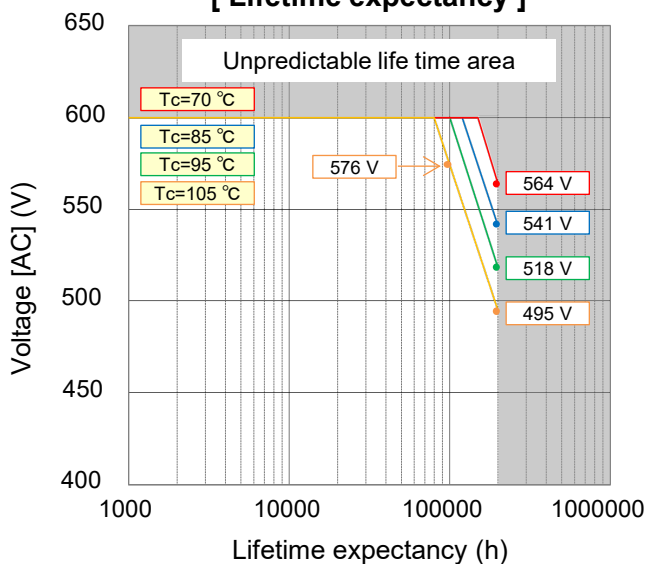

**Permissible pulse current (dV/dt)
(Max. 10000 cycles)**

R. voltage [AC] (V)	Pitch (mm)	Capacitance (μF)	Code	dV/dt (V/μs)	Current (A _{o-p})
600	37.5	1.0	105	110	110.0
		1.5	155		165.0
		2.2	225		242.0
		3.3	335		363.0
		4.7	475		517.0

[Self Heating Derating by Temperature]

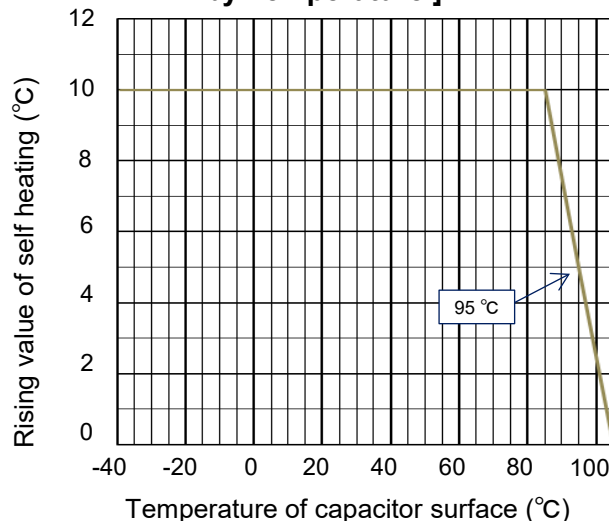

Characteristics data

■ **Rated voltage [AC] : 600 V (Lead pitch 52.5 mm)**

Electrical characteristics <Typical data >

Temperature characteristics

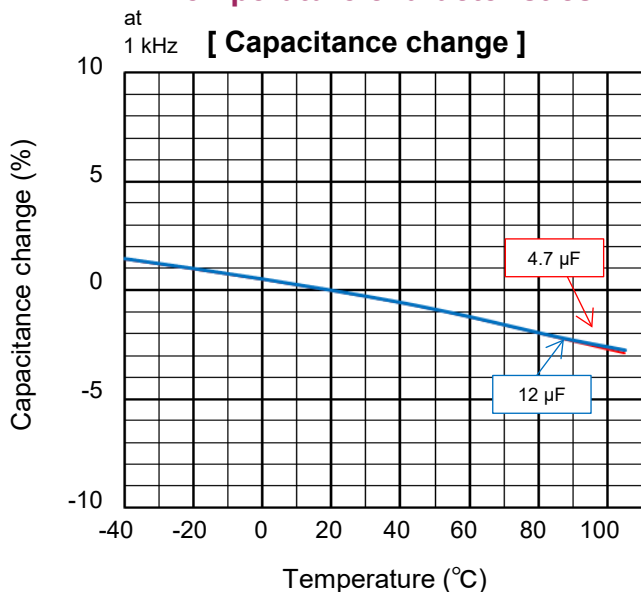

Frequency characteristics

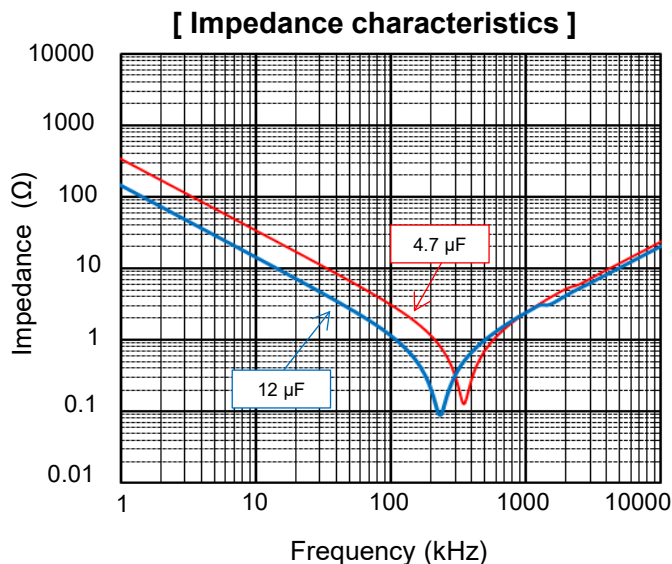

at 1 kHz [**Dissipation factor**]

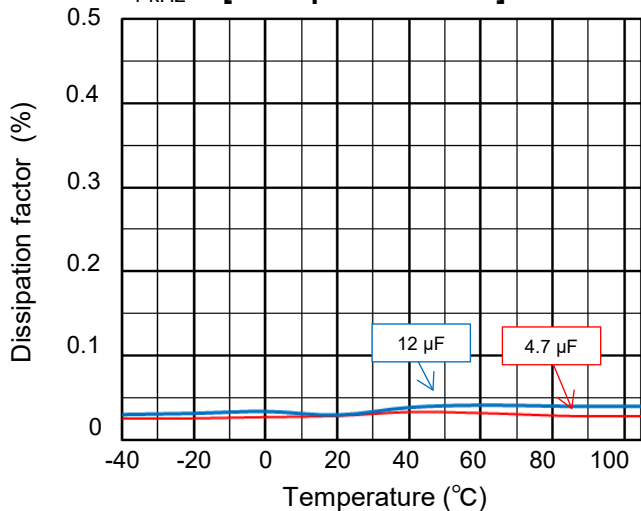

at DC 100 V [**Insulation resistance**]

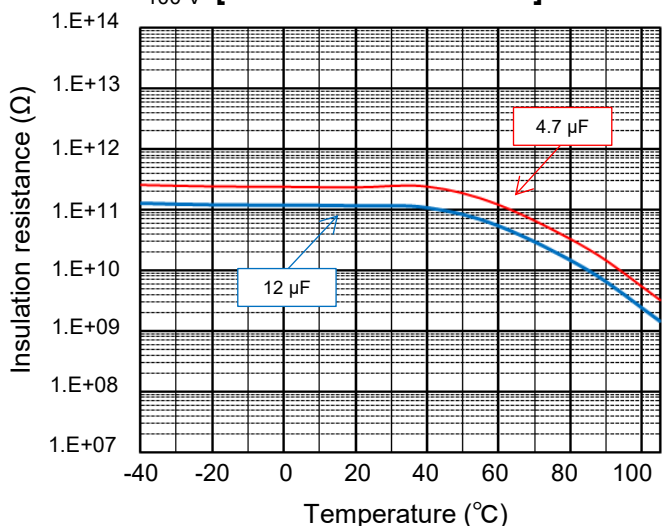

Characteristics data

■ **Rated voltage [AC] : 600 V (Lead pitch 52.5 mm)**

Applicable specifications

[Permissible Current]

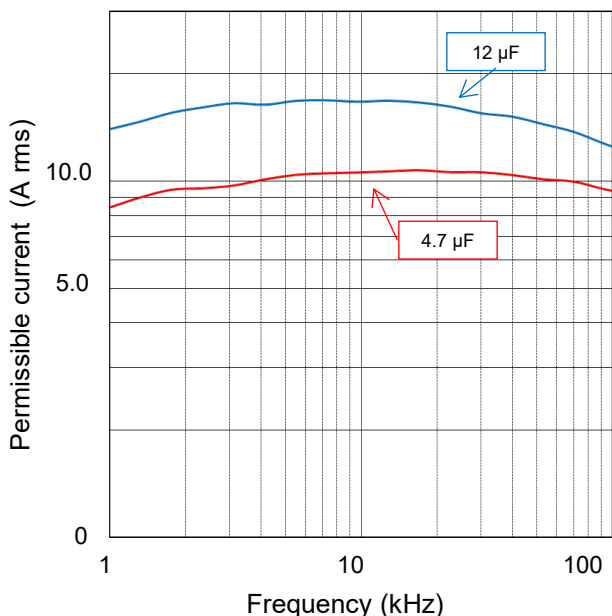

[Permissible Current Derating by Temperature]

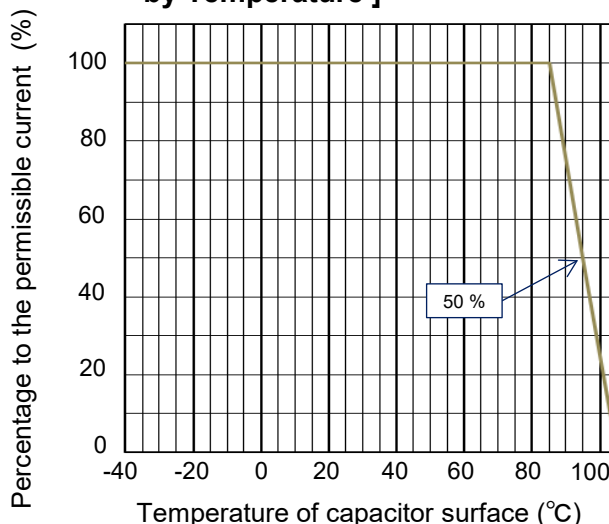

[Voltage Derating by Temperature]

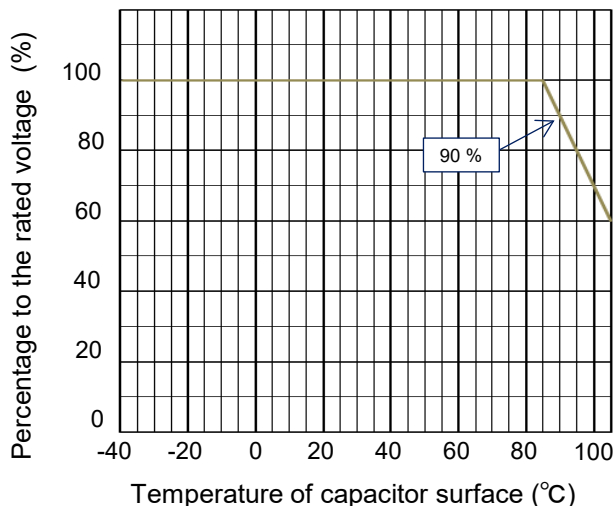

[Lifetime expectancy]

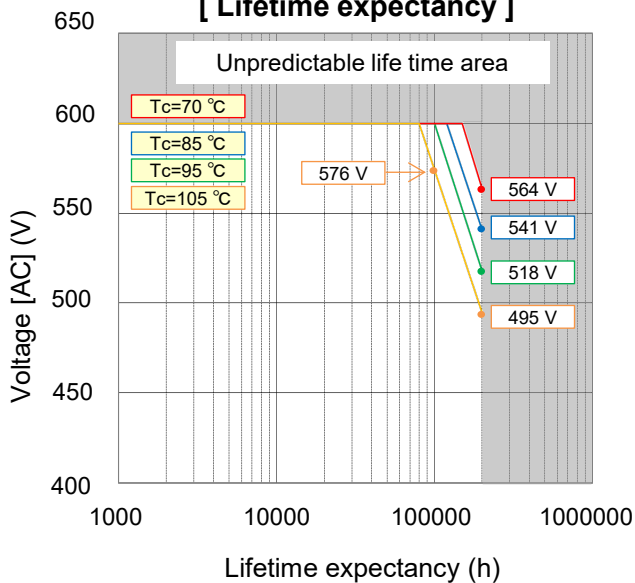

**Permissible pulse current (dV/dt)
(Max. 10000 cycles)**

R. voltage [AC] (V)	Pitch (mm)	Capacitance (μF)	Code	dV/dt (V/μs)	Current (A _{o-p})
600	52.5	4.7	475	70	329.0
		6.8	685		476.0
		7.0	705		490.0
		10.0	106		700.0
		12.0	126		840.0

[Self Heating Derating by Temperature]

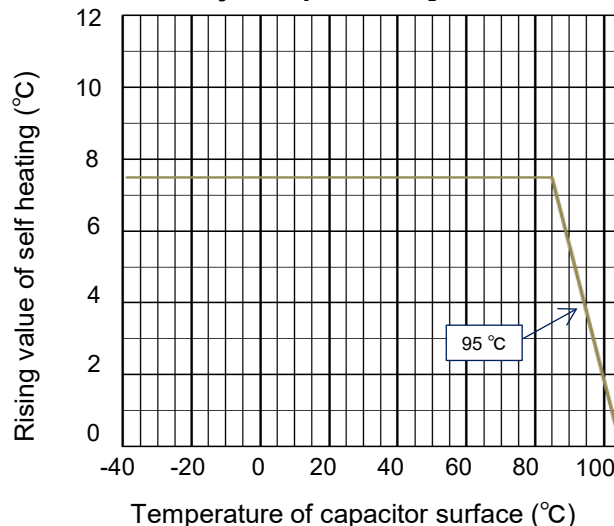



Plastic Film Capacitors

Metallized Polypropylene Film Capacitor

EZPV series

Features

- High Safety (with safety function)
- Long product life, High reliability
- Low loss, Low ESR
- Flame retardant (Case and sealing resin)
- AEC-Q200 compliant (For automotive part No.)
- RoHS compliant

Recommended applications

- For DC filtering, DC link circuit
- Solar inverters
- Wind power generation
- Industrial power supplies
- Inverter circuit in appliances (Air Conditioners etc.)
- On board charger, AC/DC, DC/DC converter for automotive

Construction

- Dielectric : Polypropylene film
- Electrodes : Metallized dielectric with segmented pattern
- Plastic case : UL94 V-0
- Sealing : UL94 V-0
- Terminals : Tinned wires, 2-pin and 4-pin versions

Explanation of part number

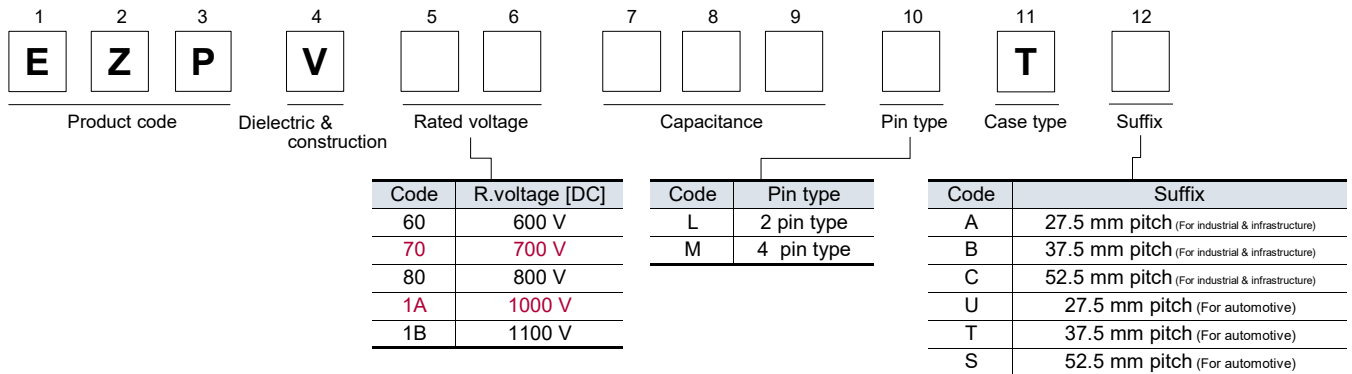

Specifications

Category temperature range*1	-40 °C to +105 °C	
Rated voltage*2 [DC]	600 V, 700 V, 800 V, 1000 V, 1100 V (Derating of rated voltage by 1.0 %/°C at more than 85 °C)	
Rated capacitance	600 V	10 µF to 110 µF
	700 V / 800 V	8 µF to 65 µF
	1000 V / 1100 V	3 µF to 40 µF
Capacitance tolerance	±10 %	
Withstand voltage	Between terminals : Rated voltage (V) × 150 % 10 s	
	Terminal to case : 2000 V [AC] 10 s	
Insulation resistance (IR)	CR ≥ 3,000 Ω·F (20 °C, 500 V, 60 s)	

*1 : The temperature of capacitor surface (case).
*2 : Use for DC voltage only.

Dimensions

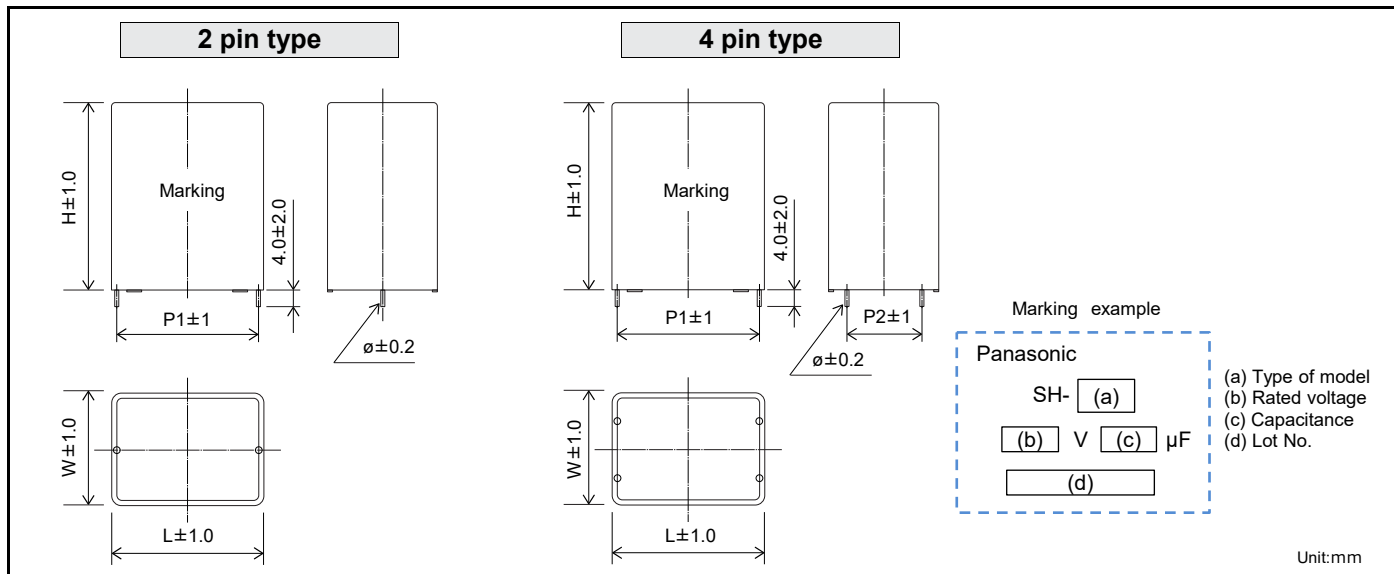

Rating · Dimensions · Quantity

For industrial & infrastructure

■ Rated voltage [DC] : 600 V

Part No.	Cap. Tol. (%)	Cap. (μF)	Dimensions (mm)						dv/dt (V/μs)	Permissible current		ESR ^{*3} (mΩ)	Mass (g)	Min. order Qty ^{*4} (PCS)
			W	H	L	P1	P2	ø		Peak current ^{*1} (A _{0-P})	RMS current ^{*2} (A _{rms})			
EZPV60106LTB	±10	10	15.0	29.0	41.0	37.5	-	1.0	25	250	8.6	16.9	22	1200
EZPV60126LTB	±10	12	15.0	29.0	41.0	37.5	-	1.0	25	300	9.2	14.3	23	1200
EZPV60156LTB	±10	15	17.0	34.5	41.0	37.5	-	1.0	25	375	10.0	12.8	28	1200
EZPV60206MTB	±10	20	22.0	36.0	41.0	37.5	10.2	1.0	25	500	11.9	10.4	39	600
EZPV60226MTB	±10	22	22.0	36.0	41.0	37.5	10.2	1.0	25	550	12.7	9.6	41	600
EZPV60256MTB	±10	25	22.0	36.0	41.0	37.5	10.2	1.0	25	625	13.8	8.6	42	600
EZPV60306MTB	±10	30	26.0	40.5	41.0	37.5	10.2	1.0	25	750	15.6	8.2	54	600
EZPV60356MTB	±10	35	26.0	40.5	41.0	37.5	10.2	1.0	25	875	17.2	7.1	55	600
EZPV60406MTB	±10	40	27.5	42.0	41.5	37.5	10.2	1.0	25	1000	18.7	6.5	59	600
EZPV60456MTB	±10	45	30.0	50.5	41.0	37.5	20.3	1.0	25	1125	20.1	6.2	71	400
EZPV60506MTB	±10	50	30.0	50.5	41.0	37.5	20.3	1.0	25	1250	21.5	5.3	74	400
EZPV60556MTB	±10	55	30.0	50.5	41.0	37.5	20.3	1.0	25	1375	22.0	4.5	81	400
EZPV60606MTB	±10	60	30.0	56.0	41.5	37.5	20.3	1.2	25	1500	22.5	4.1	85	400
EZPV60656MTB	±10	65	30.0	56.0	41.5	37.5	20.3	1.2	25	1625	23.0	3.6	88	400
EZPV60706MTB	±10	70	38.0	52.5	42.0	37.5	20.3	1.2	25	1750	23.4	3.6	108	400
EZPV60756MTB	±10	75	38.0	57.0	42.0	37.5	20.3	1.2	25	1875	23.8	4.1	109	400
EZPV60806MTB	±10	80	43.0	58.0	41.0	37.5	20.3	1.2	25	2000	24.3	3.9	129	400
EZPV60856MTB	±10	85	43.0	58.0	41.0	37.5	20.3	1.2	25	2125	24.7	3.7	132	400
EZPV60406MTC	±10	40	25.0	40.0	57.0	52.5	10.2	1.2	15	600	16.9	8.4	67	600
EZPV60456MTC	±10	45	25.0	40.0	57.0	52.5	10.2	1.2	15	675	18.0	7.6	68	600
EZPV60506MTC	±10	50	25.0	40.0	57.0	52.5	10.2	1.2	15	750	19.1	6.8	70	600
EZPV60556MTC	±10	55	30.0	51.0	57.5	52.5	10.2	1.2	15	825	20.1	8.0	92	200
EZPV60606MTC	±10	60	30.0	51.0	57.5	52.5	10.2	1.2	15	900	21.0	7.5	94	200
EZPV60656MTC	±10	65	30.0	51.0	57.5	52.5	20.3	1.2	15	975	21.9	7.0	95	200
EZPV60706MTC	±10	70	30.0	51.0	57.5	52.5	20.3	1.2	15	1050	22.8	6.6	97	200
EZPV60756MTC	±10	75	30.0	51.0	57.5	52.5	20.3	1.2	15	1125	23.6	5.5	101	200
EZPV60806MTC	±10	80	30.0	51.0	57.5	52.5	20.3	1.2	15	1200	24.5	4.9	108	200
EZPV60856MTC	±10	85	30.0	51.0	57.5	52.5	20.3	1.2	15	1275	25.3	4.6	110	200
EZPV60906MTC	±10	90	35.0	50.0	57.5	52.5	20.3	1.2	15	1350	26.0	4.7	121	200
EZPV60956MTC	±10	95	35.0	50.0	57.5	52.5	20.3	1.2	15	1425	26.8	5.2	122	200
EZPV60107MTC	±10	100	40.0	51.5	57.0	52.5	20.3	1.2	15	1500	27.5	5.1	145	200
EZPV60117MTC	±10	110	35.0	56.0	57.5	52.5	20.3	1.2	15	1650	28.9	4.8	138	200

*1 : When rising temperature of capacitor surface by continuous peak current(included pulse current), use within limit specified for temperature of capacitor surface and self heating temperature rise.

*2 : Maximum RMS current @ 70°C , 10kHz Use within limit for self heating temperature rise at capacitor surface.

*3 : 20 °C、10 kHz

*4 : Minimum order quantity consists of 4 packing units.

Rating · Dimensions · Quantity

For industrial & infrastructure

■ Rated voltage [DC] : 700 V

NEW

Part No.	Cap. Tol. (%)	Cap. (μF)	Dimensions (mm)						dv/dt (V/μs)	Permissible current		ESR ^{*3} (mΩ)	Mass (g)	Min. order Qty ^{*4} (PCS)
			W	H	L	P1	P2	∅		Peak current ^{*1} (A _{0-P})	RMS current ^{*2} (A rms)			
EZPV70905LTA	±10	9	20.5	41.5	31.0	27.5	-	0.8	35	315	12.3	12.6	30	800
EZPV70905MTA	±10	9	20.5	41.5	31.0	27.5	10.2	0.8	35	315	12.3	12.6	30	800
EZPV70106LTA	±10	10	20.5	41.5	31.0	27.5	-	0.8	35	350	12.9	11.5	31	800
EZPV70106MTA	±10	10	20.5	41.5	31.0	27.5	10.2	0.8	35	350	12.9	11.5	31	800
EZPV70116LTA	±10	11	20.5	41.5	31.0	27.5	-	0.8	35	385	13.6	10.6	32	800
EZPV70116MTA	±10	11	20.5	41.5	31.0	27.5	10.2	0.8	35	385	13.6	10.6	32	800
EZPV70126LTA	±10	12	20.5	41.5	31.0	27.5	-	0.8	35	420	14.2	9.9	33	800
EZPV70126MTA	±10	12	20.5	41.5	31.0	27.5	10.2	0.8	35	420	14.2	9.9	33	800
EZPV70136LTA	±10	13	26.0	41.0	31.0	27.5	-	1.0	35	455	14.7	9.2	42	600
EZPV70136MTA	±10	13	26.0	41.0	31.0	27.5	10.2	1.0	35	455	14.7	9.2	42	600
EZPV70146LTA	±10	14	26.0	41.0	31.0	27.5	-	1.0	35	490	15.3	8.7	42	600
EZPV70146MTA	±10	14	26.0	41.0	31.0	27.5	10.2	1.0	35	490	15.3	8.7	42	600
EZPV70186LTA	±10	18	22.0	53.5	31.0	27.5	-	1.2	35	630	17.3	7.8	54	600
EZPV70186MTA	±10	18	22.0	53.5	31.0	27.5	10.2	1.2	35	630	17.3	7.8	54	600
EZPV70805LTB	±10	8	17.0	34.5	41.0	37.5	-	1.0	35	280	8.2	17.1	28	1200
EZPV70905LTB	±10	9	17.0	34.5	41.0	37.5	-	1.0	35	315	8.9	15.6	28	1200
EZPV70106LTB	±10	10	17.0	34.5	41.0	37.5	-	1.0	35	350	9.5	13.9	30	1200
EZPV70126LTB	±10	12	22.0	36.0	41.0	37.5	-	1.0	35	420	10.7	12.5	39	600
EZPV70156MTB	±10	15	22.0	36.0	41.0	37.5	10.2	1.0	35	525	13.0	10.2	42	600
EZPV70206MTB	±10	20	26.0	40.5	41.0	37.5	10.2	1.0	35	700	15.8	8.7	55	600
EZPV70256MTB	±10	25	30.0	50.5	41.0	37.5	10.2	1.0	35	875	18.3	8.7	70	400
EZPV70306MTB	±10	30	30.0	50.5	41.0	37.5	20.3	1.0	35	1050	20.6	7.1	74	400
EZPV70356MTB	±10	35	30.0	56.0	41.5	37.5	20.3	1.2	35	1225	22.7	5.5	86	400
EZPV70406MTB	±10	40	38.0	52.5	42.0	37.5	20.3	1.2	35	1400	24.6	5.1	108	400
EZPV70456MTB	±10	45	38.0	57.0	42.0	37.5	20.3	1.2	35	1575	26.4	4.5	117	400
EZPV70506MTB	±10	50	43.0	58.0	41.0	37.5	20.3	1.2	35	1750	28.2	4.8	132	400
EZPV70256MTC	±10	25	25.0	40.0	57.0	52.5	10.2	1.2	22	550	14.4	11.6	68	600
EZPV70306MTC	±10	30	30.0	51.0	57.5	52.5	10.2	1.2	22	660	16.8	11.6	91	200
EZPV70356MTC	±10	35	30.0	51.0	57.5	52.5	10.2	1.2	22	770	18.9	10.2	94	200
EZPV70406MTC	±10	40	30.0	51.0	57.5	52.5	20.3	1.2	22	880	20.9	9.1	97	200
EZPV70456MTC	±10	45	30.0	51.0	57.5	52.5	20.3	1.2	22	990	22.8	7.9	101	200
EZPV70506MTC	±10	50	30.0	51.0	57.5	52.5	20.3	1.2	22	1100	24.5	6.8	110	200
EZPV70556MTC	±10	55	35.0	50.0	57.5	52.5	20.3	1.2	22	1210	26.2	6.3	122	200
EZPV70606MTC	±10	60	35.0	56.0	57.5	52.5	20.3	1.2	22	1320	27.8	6.2	137	200
EZPV70656MTC	±10	65	35.0	64.5	57.5	52.5	20.3	1.2	22	1430	29.3	6.2	140	200

*1 : When rising temperature of capacitor surface by continuous peak current(included pulse current), use within limit specified for temperature of capacitor surface and self heating temperature rise.

*2 : Maximum RMS current @ 70°C , 10kHz Use within limit for self heating temperature rise at capacitor surface.

*3 : 20 °C、10 kHz

*4 : Minimum order quantity consists of 4 packing units.

Rating · Dimensions · Quantity

For industrial & infrastructure

■ Rated voltage [DC] : 800 V

Part No.	Cap. Tol. (%)	Cap. (μF)	Dimensions (mm)						dv/dt (V/μs)	Permissible current		ESR ^{*3} (mΩ)	Mass (g)	Min. order Qty ^{*4} (PCS)
			W	H	L	P1	P2	∅		Peak current ^{*1} (A _{0-p})	RMS current ^{*2} (A rms)			
EZPV80905LTA	±10	9	20.5	41.5	31.0	27.5	-	0.8	35	315	12.3	12.6	30	800
NEW EZPV80905MTA	±10	9	20.5	41.5	31.0	27.5	10.2	0.8	35	315	12.3	12.6	30	800
EZPV80106LTA	±10	10	20.5	41.5	31.0	27.5	-	0.8	35	350	12.9	11.5	31	800
NEW EZPV80106MTA	±10	10	20.5	41.5	31.0	27.5	10.2	0.8	35	350	12.9	11.5	31	800
EZPV80116LTA	±10	11	20.5	41.5	31.0	27.5	-	0.8	35	385	13.6	10.6	32	800
NEW EZPV80116MTA	±10	11	20.5	41.5	31.0	27.5	10.2	0.8	35	385	13.6	10.6	32	800
EZPV80126LTA	±10	12	20.5	41.5	31.0	27.5	-	0.8	35	420	14.2	9.9	33	800
NEW EZPV80126MTA	±10	12	20.5	41.5	31.0	27.5	10.2	0.8	35	420	14.2	9.9	33	800
EZPV80136LTA	±10	13	26.0	41.0	31.0	27.5	-	1.0	35	455	14.7	9.2	42	600
NEW EZPV80136MTA	±10	13	26.0	41.0	31.0	27.5	10.2	1.0	35	455	14.7	9.2	42	600
EZPV80146LTA	±10	14	26.0	41.0	31.0	27.5	-	1.0	35	490	15.3	8.7	42	600
NEW EZPV80146MTA	±10	14	26.0	41.0	31.0	27.5	10.2	1.0	35	490	15.3	8.7	42	600
EZPV80186LTA	±10	18	22.0	53.5	31.0	27.5	-	1.2	35	630	17.3	7.8	54	600
NEW EZPV80186MTA	±10	18	22.0	53.5	31.0	27.5	10.2	1.2	35	630	17.3	7.8	54	600
EZPV80805LTB	±10	8	17.0	34.5	41.0	37.5	-	1.0	35	280	8.2	17.1	28	1200
EZPV80905LTB	±10	9	17.0	34.5	41.0	37.5	-	1.0	35	315	8.9	15.6	28	1200
EZPV80106LTB	±10	10	17.0	34.5	41.0	37.5	-	1.0	35	350	9.5	13.9	30	1200
EZPV80126LTB	±10	12	22.0	36.0	41.0	37.5	-	1.0	35	420	10.7	12.5	39	600
EZPV80156MTB	±10	15	22.0	36.0	41.0	37.5	10.2	1.0	35	525	13.0	10.2	42	600
EZPV80206MTB	±10	20	26.0	40.5	41.0	37.5	10.2	1.0	35	700	15.8	8.7	55	600
EZPV80256MTB	±10	25	30.0	50.5	41.0	37.5	10.2	1.0	35	875	18.3	8.7	70	400
EZPV80306MTB	±10	30	30.0	50.5	41.0	37.5	20.3	1.0	35	1050	20.6	7.1	74	400
EZPV80356MTB	±10	35	30.0	56.0	41.5	37.5	20.3	1.2	35	1225	22.7	5.5	86	400
EZPV80406MTB	±10	40	38.0	52.5	42.0	37.5	20.3	1.2	35	1400	24.6	5.1	108	400
EZPV80456MTB	±10	45	38.0	57.0	42.0	37.5	20.3	1.2	35	1575	26.4	4.5	117	400
EZPV80506MTB	±10	50	43.0	58.0	41.0	37.5	20.3	1.2	35	1750	28.2	4.8	132	400
EZPV80256MTC	±10	25	25.0	40.0	57.0	52.5	10.2	1.2	22	550	14.4	11.6	68	600
EZPV80306MTC	±10	30	30.0	51.0	57.5	52.5	10.2	1.2	22	660	16.8	11.6	91	200
EZPV80356MTC	±10	35	30.0	51.0	57.5	52.5	10.2	1.2	22	770	18.9	10.2	94	200
EZPV80406MTC	±10	40	30.0	51.0	57.5	52.5	20.3	1.2	22	880	20.9	9.1	97	200
EZPV80456MTC	±10	45	30.0	51.0	57.5	52.5	20.3	1.2	22	990	22.8	7.9	101	200
EZPV80506MTC	±10	50	30.0	51.0	57.5	52.5	20.3	1.2	22	1100	24.5	6.8	110	200
EZPV80556MTC	±10	55	35.0	50.0	57.5	52.5	20.3	1.2	22	1210	26.2	6.3	122	200
EZPV80606MTC	±10	60	35.0	56.0	57.5	52.5	20.3	1.2	22	1320	27.8	6.2	137	200
EZPV80656MTC	±10	65	35.0	64.5	57.5	52.5	20.3	1.2	22	1430	29.3	6.2	140	200

*1 : When rising temperature of capacitor surface by continuous peak current(included pulse current), use within limit specified for temperature of capacitor surface and self heating temperature rise.

*2 : Maximum RMS current @ 70°C , 10kHz Use within limit for self heating temperature rise at capacitor surface.

*3 : 20 °C、10 kHz

*4 : Minimum order quantity consists of 4 packing units.

Rating · Dimensions · Quantity

For industrial & infrastructure

■ Rated voltage [DC] : 1000 V

NEW

Part No.	Cap. Tol. (%)	Cap. (μF)	Dimensions (mm)						dv/dt (V/μs)	Permissible current		ESR ^{*3} (mΩ)	Mass (g)	Min. order Qty ^{*4} (PCS)
			W	H	L	P1	P2	∅		Peak current ^{*1} (A _{0-P})	RMS current ^{*2} (A rms)			
EZPV1A305LTB	±10	3	15.0	29.0	41.0	37.5	-	1.0	50	150	4.4	30.8	22	1200
EZPV1A405LTB	±10	4	15.0	29.0	41.0	37.5	-	1.0	50	200	5.5	23.5	23	1200
EZPV1A475LTB	±10	4.7	17.0	34.5	41.0	37.5	-	1.0	50	235	6.2	21.7	28	1200
EZPV1A505LTB	±10	5	17.0	34.5	41.0	37.5	-	1.0	50	250	6.5	20.4	28	1200
EZPV1A605LTB	±10	6	17.0	34.5	41.0	37.5	-	1.0	50	300	7.3	17.5	29	1200
EZPV1A705MTB	±10	7	22.0	36.0	41.0	37.5	10.2	1.0	50	350	8.5	15.5	39	600
EZPV1A805MTB	±10	8	22.0	36.0	41.0	37.5	10.2	1.0	50	400	9.5	13.7	41	600
EZPV1A905MTB	±10	9	22.0	36.0	41.0	37.5	10.2	1.0	50	450	10.4	12.4	42	600
EZPV1A106MTB	±10	10	23.5	43.5	41.5	37.5	10.2	1.0	50	500	11.2	12.7	48	400
EZPV1A126MTB	±10	12	26.0	40.5	41.0	37.5	10.2	1.0	50	600	12.8	10.4	55	600
EZPV1A156MTB	±10	15	30.0	50.5	41.0	37.5	10.2	1.0	50	750	15.0	10.4	70	400
EZPV1A186MTB	±10	18	30.0	50.5	41.0	37.5	20.3	1.0	50	900	16.9	8.5	74	400
EZPV1A206MTB	±10	20	30.0	56.0	41.5	37.5	20.3	1.2	50	1000	18.1	7.2	82	400
EZPV1A256MTB	±10	25	38.0	52.5	42.0	37.5	20.3	1.2	50	1250	20.9	5.9	108	400
EZPV1A306MTB	±10	30	43.0	58.0	41.0	37.5	20.3	1.2	50	1500	23.4	5.7	132	400
EZPV1A156MTC	±10	15	25.0	40.0	57.0	52.5	10.2	1.2	30	450	10.6	13.7	67	600
EZPV1A206MTC	±10	20	35.5	45.5	57.5	52.5	10.2	1.2	30	600	12.2	11.2	106	200
EZPV1A256MTC	±10	25	35.5	45.5	57.5	52.5	20.3	1.2	30	750	13.6	9.1	111	200
EZPV1A306MTC	±10	30	35.0	50.0	57.5	52.5	20.3	1.2	30	900	14.9	9.9	116	200
EZPV1A356MTC	±10	35	35.0	56.0	57.5	52.5	20.3	1.2	30	1050	16.1	9.2	132	200
EZPV1A406MTC	±10	40	35.0	56.0	57.5	52.5	20.3	1.2	30	1200	17.2	7.8	138	200

*1 : When rising temperature of capacitor surface by continuous peak current(included pulse current), use within limit specified for temperature of capacitor surface and self heating temperature rise.

*2 : Maximum RMS current @ 70°C , 10kHz Use within limit for self heating temperature rise at capacitor surface.

*3 : 20 °C、10 kHz

*4 : Minimum order quantity consists of 4 packing units.

Rating · Dimensions · Quantity

For industrial & infrastructure

■ Rated voltage [DC] : 1100 V

Part No.	Cap. Tol. (%)	Cap. (μF)	Dimensions (mm)						dv/dt (V/μs)	Permissible current		ESR ^{*3} (mΩ)	Mass (g)	Min. order Qty ^{*4} (PCS)
			W	H	L	P1	P2	ø		Peak current ^{*1} (A _{0-P})	RMS current ^{*2} (A rms)			
EZPV1B305LTB	±10	3	15.0	29.0	41.0	37.5	-	1.0	50	150	4.4	30.8	22	1200
EZPV1B405LTB	±10	4	15.0	29.0	41.0	37.5	-	1.0	50	200	5.5	23.5	23	1200
EZPV1B475LTB	±10	4.7	17.0	34.5	41.0	37.5	-	1.0	50	235	6.2	21.7	28	1200
EZPV1B505LTB	±10	5	17.0	34.5	41.0	37.5	-	1.0	50	250	6.5	20.4	28	1200
EZPV1B605LTB	±10	6	17.0	34.5	41.0	37.5	-	1.0	50	300	7.3	17.5	29	1200
EZPV1B705MTB	±10	7	22.0	36.0	41.0	37.5	10.2	1.0	50	350	8.5	15.5	39	600
EZPV1B805MTB	±10	8	22.0	36.0	41.0	37.5	10.2	1.0	50	400	9.5	13.7	41	600
EZPV1B905MTB	±10	9	22.0	36.0	41.0	37.5	10.2	1.0	50	450	10.4	12.4	42	600
EZPV1B106MTB	±10	10	23.5	43.5	41.5	37.5	10.2	1.0	50	500	11.2	12.7	48	400
EZPV1B126MTB	±10	12	26.0	40.5	41.0	37.5	10.2	1.0	50	600	12.8	10.4	55	600
EZPV1B156MTB	±10	15	30.0	50.5	41.0	37.5	10.2	1.0	50	750	15.0	10.4	70	400
EZPV1B186MTB	±10	18	30.0	50.5	41.0	37.5	20.3	1.0	50	900	16.9	8.5	74	400
EZPV1B206MTB	±10	20	30.0	56.0	41.5	37.5	20.3	1.2	50	1000	18.1	7.2	82	400
EZPV1B256MTB	±10	25	38.0	52.5	42.0	37.5	20.3	1.2	50	1250	20.9	5.9	108	400
EZPV1B306MTB	±10	30	43.0	58.0	41.0	37.5	20.3	1.2	50	1500	23.4	5.7	132	400
EZPV1B156MTC	±10	15	25.0	40.0	57.0	52.5	10.2	1.2	30	450	10.6	13.7	67	600
EZPV1B206MTC	±10	20	35.5	45.5	57.5	52.5	10.2	1.2	30	600	12.2	11.2	106	200
EZPV1B256MTC	±10	25	35.5	45.5	57.5	52.5	20.3	1.2	30	750	13.6	9.1	111	200
EZPV1B306MTC	±10	30	35.0	50.0	57.5	52.5	20.3	1.2	30	900	14.9	9.9	116	200
EZPV1B356MTC	±10	35	35.0	56.0	57.5	52.5	20.3	1.2	30	1050	16.1	9.2	132	200
EZPV1B406MTC	±10	40	35.0	56.0	57.5	52.5	20.3	1.2	30	1200	17.2	7.8	138	200

*1 : When rising temperature of capacitor surface by continuous peak current(included pulse current), use within limit specified for temperature of capacitor surface and self heating temperature rise.

*2 : Maximum RMS current @ 70°C , 10kHz Use within limit for self heating temperature rise at capacitor surface.

*3 : 20 °C、10 kHz

*4 : Minimum order quantity consists of 4 packing units.

Rating · Dimensions · Quantity

For automotive

■ Rated voltage [DC] : 600 V

Part No.	Cap. Tol. (%)	Cap. (μF)	Dimensions (mm)						dv/dt (V/μs)	Permissible current		ESR ^{*3} (mΩ)	Mass (g)	Min. order Qty ^{*4} (PCS)
			W	H	L	P1	P2	∅		Peak current ^{*1} (A _{0-P})	RMS current ^{*2} (A rms)			
EZPV60106LTT	±10	10	15.0	29.0	41.0	37.5	-	1.0	25	250	8.6	16.9	22	1200
EZPV60126LTT	±10	12	15.0	29.0	41.0	37.5	-	1.0	25	300	9.2	14.3	23	1200
EZPV60156LTT	±10	15	17.0	34.5	41.0	37.5	-	1.0	25	375	10.0	12.8	28	1200
EZPV60206MTT	±10	20	22.0	36.0	41.0	37.5	10.2	1.0	25	500	11.9	10.4	39	600
EZPV60226MTT	±10	22	22.0	36.0	41.0	37.5	10.2	1.0	25	550	12.7	9.6	41	600
EZPV60256MTT	±10	25	22.0	36.0	41.0	37.5	10.2	1.0	25	625	13.8	8.6	42	600
EZPV60306MTT	±10	30	26.0	40.5	41.0	37.5	10.2	1.0	25	750	15.6	8.2	54	600
EZPV60356MTT	±10	35	26.0	40.5	41.0	37.5	10.2	1.0	25	875	17.2	7.1	55	600
EZPV60406MTT	±10	40	27.5	42.0	41.5	37.5	10.2	1.0	25	1000	18.7	6.5	59	600
EZPV60456MTT	±10	45	30.0	50.5	41.0	37.5	20.3	1.0	25	1125	20.1	6.2	71	400
EZPV60506MTT	±10	50	30.0	50.5	41.0	37.5	20.3	1.0	25	1250	21.5	5.3	74	400
EZPV60556MTT	±10	55	30.0	50.5	41.0	37.5	20.3	1.0	25	1375	22.0	4.5	81	400
EZPV60606MTT	±10	60	30.0	56.0	41.5	37.5	20.3	1.2	25	1500	22.5	4.1	85	400
EZPV60656MTT	±10	65	30.0	56.0	41.5	37.5	20.3	1.2	25	1625	23.0	3.6	88	400
EZPV60706MTT	±10	70	38.0	52.5	42.0	37.5	20.3	1.2	25	1750	23.4	3.6	108	400
EZPV60756MTT	±10	75	38.0	57.0	42.0	37.5	20.3	1.2	25	1875	23.8	4.1	109	400
EZPV60806MTT	±10	80	43.0	58.0	41.0	37.5	20.3	1.2	25	2000	24.3	3.9	129	400
EZPV60856MTT	±10	85	43.0	58.0	41.0	37.5	20.3	1.2	25	2125	24.7	3.7	132	400
EZPV60406MTS	±10	40	25.0	40.0	57.0	52.5	10.2	1.2	15	600	16.9	8.4	67	600
EZPV60456MTS	±10	45	25.0	40.0	57.0	52.5	10.2	1.2	15	675	18.0	7.6	68	600
EZPV60506MTS	±10	50	25.0	40.0	57.0	52.5	10.2	1.2	15	750	19.1	6.8	70	600
EZPV60556MTS	±10	55	30.0	51.0	57.5	52.5	10.2	1.2	15	825	20.1	8.0	92	200
EZPV60606MTS	±10	60	30.0	51.0	57.5	52.5	10.2	1.2	15	900	21.0	7.5	94	200
EZPV60656MTS	±10	65	30.0	51.0	57.5	52.5	20.3	1.2	15	975	21.9	7.0	95	200
EZPV60706MTS	±10	70	30.0	51.0	57.5	52.5	20.3	1.2	15	1050	22.8	6.6	97	200
EZPV60756MTS	±10	75	30.0	51.0	57.5	52.5	20.3	1.2	15	1125	23.6	5.5	101	200
EZPV60806MTS	±10	80	30.0	51.0	57.5	52.5	20.3	1.2	15	1200	24.5	4.9	108	200
EZPV60856MTS	±10	85	30.0	51.0	57.5	52.5	20.3	1.2	15	1275	25.3	4.6	110	200
EZPV60906MTS	±10	90	35.0	50.0	57.5	52.5	20.3	1.2	15	1350	26.0	4.7	121	200
EZPV60956MTS	±10	95	35.0	50.0	57.5	52.5	20.3	1.2	15	1425	26.8	5.2	122	200
EZPV60107MTS	±10	100	40.0	51.5	57.0	52.5	20.3	1.2	15	1500	27.5	5.1	145	200
EZPV60117MTS	±10	110	35.0	56.0	57.5	52.5	20.3	1.2	15	1650	28.9	4.8	138	200

*1 : When rising temperature of capacitor surface by continuous peak current(included pulse current), use within limit specified for temperature of capacitor surface and self heating temperature rise.

*2 : Maximum RMS current @ 70°C , 10kHz Use within limit for self heating temperature rise at capacitor surface.

*3 : 20 °C、10 kHz

*4 : Minimum order quantity consists of 4 packing units.

Rating · Dimensions · Quantity

For automotive

■ Rated voltage [DC] : 700 V

NEW

Part No.	Cap. Tol. (%)	Cap. (μF)	Dimensions (mm)						dv/dt (V/μs)	Permissible current		ESR ^{*3} (mΩ)	Mass (g)	Min. order Qty ^{*4} (PCS)
			W	H	L	P1	P2	ø		Peak current ^{*1} (A _{0-p})	RMS current ^{*2} (A rms)			
EZPV70905LTU	±10	9	20.5	41.5	31.0	27.5	-	0.8	35	315	12.3	12.6	30	800
EZPV70905MTU	±10	9	20.5	41.5	31.0	27.5	10.2	0.8	35	315	12.3	12.6	30	800
EZPV70106LTU	±10	10	20.5	41.5	31.0	27.5	-	0.8	35	350	12.9	11.5	31	800
EZPV70106MTU	±10	10	20.5	41.5	31.0	27.5	10.2	0.8	35	350	12.9	11.5	31	800
EZPV70116LTU	±10	11	20.5	41.5	31.0	27.5	-	0.8	35	385	13.6	10.6	32	800
EZPV70116MTU	±10	11	20.5	41.5	31.0	27.5	10.2	0.8	35	385	13.6	10.6	32	800
EZPV70126LTU	±10	12	20.5	41.5	31.0	27.5	-	0.8	35	420	14.2	9.9	33	800
EZPV70126MTU	±10	12	20.5	41.5	31.0	27.5	10.2	0.8	35	420	14.2	9.9	33	800
EZPV70136LTU	±10	13	26.0	41.0	31.0	27.5	-	1.0	35	455	14.7	9.2	42	600
EZPV70136MTU	±10	13	26.0	41.0	31.0	27.5	10.2	1.0	35	455	14.7	9.2	42	600
EZPV70146LTU	±10	14	26.0	41.0	31.0	27.5	-	1.0	35	490	15.3	8.7	42	600
EZPV70146MTU	±10	14	26.0	41.0	31.0	27.5	10.2	1.0	35	490	15.3	8.7	42	600
EZPV70186LTU	±10	18	22.0	53.5	31.0	27.5	-	1.2	35	630	17.3	7.8	54	600
EZPV70186MTU	±10	18	22.0	53.5	31.0	27.5	10.2	1.2	35	630	17.3	7.8	54	600
EZPV70805LTT	±10	8	17.0	34.5	41.0	37.5	-	1.0	35	280	8.2	17.1	28	1200
EZPV70905LTT	±10	9	17.0	34.5	41.0	37.5	-	1.0	35	315	8.9	15.6	28	1200
EZPV70106LTT	±10	10	17.0	34.5	41.0	37.5	-	1.0	35	350	9.5	13.9	30	1200
EZPV70126LTT	±10	12	22.0	36.0	41.0	37.5	-	1.0	35	420	10.7	12.5	39	600
EZPV70156MTT	±10	15	22.0	36.0	41.0	37.5	10.2	1.0	35	525	13.0	10.2	42	600
EZPV70206MTT	±10	20	26.0	40.5	41.0	37.5	10.2	1.0	35	700	15.8	8.7	55	600
EZPV70256MTT	±10	25	30.0	50.5	41.0	37.5	10.2	1.0	35	875	18.3	8.7	70	400
EZPV70306MTT	±10	30	30.0	50.5	41.0	37.5	20.3	1.0	35	1050	20.6	7.1	74	400
EZPV70356MTT	±10	35	30.0	56.0	41.5	37.5	20.3	1.2	35	1225	22.7	5.5	86	400
EZPV70406MTT	±10	40	38.0	52.5	42.0	37.5	20.3	1.2	35	1400	24.6	5.1	108	400
EZPV70456MTT	±10	45	38.0	57.0	42.0	37.5	20.3	1.2	35	1575	26.4	4.5	117	400
EZPV70506MTT	±10	50	43.0	58.0	41.0	37.5	20.3	1.2	35	1750	28.2	4.8	132	400
EZPV70256MTS	±10	25	25.0	40.0	57.0	52.5	10.2	1.2	22	550	14.4	11.6	68	600
EZPV70306MTS	±10	30	30.0	51.0	57.5	52.5	10.2	1.2	22	660	16.8	11.6	91	200
EZPV70356MTS	±10	35	30.0	51.0	57.5	52.5	10.2	1.2	22	770	18.9	10.2	94	200
EZPV70406MTS	±10	40	30.0	51.0	57.5	52.5	20.3	1.2	22	880	20.9	9.1	97	200
EZPV70456MTS	±10	45	30.0	51.0	57.5	52.5	20.3	1.2	22	990	22.8	7.9	101	200
EZPV70506MTS	±10	50	30.0	51.0	57.5	52.5	20.3	1.2	22	1100	24.5	6.8	110	200
EZPV70556MTS	±10	55	35.0	50.0	57.5	52.5	20.3	1.2	22	1210	26.2	6.3	122	200
EZPV70606MTS	±10	60	35.0	56.0	57.5	52.5	20.3	1.2	22	1320	27.8	6.2	137	200
EZPV70656MTS	±10	65	35.0	64.5	57.5	52.5	20.3	1.2	22	1430	29.3	6.2	140	200

*1 : When rising temperature of capacitor surface by continuous peak current(included pulse current), use within limit specified for temperature of capacitor surface and self heating temperature rise.

*2 : Maximum RMS current @ 70°C , 10kHz Use within limit for self heating temperature rise at capacitor surface.

*3 : 20 °C、10 kHz

*4 : Minimum order quantity consists of 4 packing units.

Rating · Dimensions · Quantity

For automotive

■ Rated voltage [DC] : 800 V

Part No.	Cap. Tol. (%)	Cap. (μF)	Dimensions (mm)						dv/dt (V/μs)	Permissible current		ESR ^{*3} (mΩ)	Mass (g)	Min. order Q'ty ^{*4} (PCS)
			W	H	L	P1	P2	∅		Peak current ^{*1} (A _{0-P})	RMS current ^{*2} (A rms)			
EZPV80905LTU	±10	9	20.5	41.5	31.0	27.5	-	0.8	35	315	12.3	12.6	30	800
NEW EZPV80905MTU	±10	9	20.5	41.5	31.0	27.5	10.2	0.8	35	315	12.3	12.6	30	800
EZPV80106LTU	±10	10	20.5	41.5	31.0	27.5	-	0.8	35	350	12.9	11.5	31	800
NEW EZPV80106MTU	±10	10	20.5	41.5	31.0	27.5	10.2	0.8	35	350	12.9	11.5	31	800
EZPV80116LTU	±10	11	20.5	41.5	31.0	27.5	-	0.8	35	385	13.6	10.6	32	800
NEW EZPV80116MTU	±10	11	20.5	41.5	31.0	27.5	10.2	0.8	35	385	13.6	10.6	32	800
EZPV80126LTU	±10	12	20.5	41.5	31.0	27.5	-	0.8	35	420	14.2	9.9	33	800
NEW EZPV80126MTU	±10	12	20.5	41.5	31.0	27.5	10.2	0.8	35	420	14.2	9.9	33	800
EZPV80136LTU	±10	13	26.0	41.0	31.0	27.5	-	1.0	35	455	14.7	9.2	42	600
NEW EZPV80136MTU	±10	13	26.0	41.0	31.0	27.5	10.2	1.0	35	455	14.7	9.2	42	600
EZPV80146LTU	±10	14	26.0	41.0	31.0	27.5	-	1.0	35	490	15.3	8.7	42	600
NEW EZPV80146MTU	±10	14	26.0	41.0	31.0	27.5	10.2	1.0	35	490	15.3	8.7	42	600
EZPV80186LTU	±10	18	22.0	53.5	31.0	27.5	-	1.2	35	630	17.3	7.8	54	600
NEW EZPV80186MTU	±10	18	22.0	53.5	31.0	27.5	10.2	1.2	35	630	17.3	7.8	54	600
EZPV80805LTT	±10	8	17.0	34.5	41.0	37.5	-	1.0	35	280	8.2	17.1	28	1200
EZPV80905LTT	±10	9	17.0	34.5	41.0	37.5	-	1.0	35	315	8.9	15.6	28	1200
EZPV80106LTT	±10	10	17.0	34.5	41.0	37.5	-	1.0	35	350	9.5	13.9	30	1200
EZPV80126LTT	±10	12	22.0	36.0	41.0	37.5	-	1.0	35	420	10.7	12.5	39	600
EZPV80156MTT	±10	15	22.0	36.0	41.0	37.5	10.2	1.0	35	525	13.0	10.2	42	600
EZPV80206MTT	±10	20	26.0	40.5	41.0	37.5	10.2	1.0	35	700	15.8	8.7	55	600
EZPV80256MTT	±10	25	30.0	50.5	41.0	37.5	10.2	1.0	35	875	18.3	8.7	70	400
EZPV80306MTT	±10	30	30.0	50.5	41.0	37.5	20.3	1.0	35	1050	20.6	7.1	74	400
EZPV80356MTT	±10	35	30.0	56.0	41.5	37.5	20.3	1.2	35	1225	22.7	5.5	86	400
EZPV80406MTT	±10	40	38.0	52.5	42.0	37.5	20.3	1.2	35	1400	24.6	5.1	108	400
EZPV80456MTT	±10	45	38.0	57.0	42.0	37.5	20.3	1.2	35	1575	26.4	4.5	117	400
EZPV80506MTT	±10	50	43.0	58.0	41.0	37.5	20.3	1.2	35	1750	28.2	4.8	132	400
EZPV80256MTS	±10	25	25.0	40.0	57.0	52.5	10.2	1.2	22	550	14.4	11.6	68	600
EZPV80306MTS	±10	30	30.0	51.0	57.5	52.5	10.2	1.2	22	660	16.8	11.6	91	200
EZPV80356MTS	±10	35	30.0	51.0	57.5	52.5	10.2	1.2	22	770	18.9	10.2	94	200
EZPV80406MTS	±10	40	30.0	51.0	57.5	52.5	20.3	1.2	22	880	20.9	9.1	97	200
EZPV80456MTS	±10	45	30.0	51.0	57.5	52.5	20.3	1.2	22	990	22.8	7.9	101	200
EZPV80506MTS	±10	50	30.0	51.0	57.5	52.5	20.3	1.2	22	1100	24.5	6.8	110	200
EZPV80556MTS	±10	55	35.0	50.0	57.5	52.5	20.3	1.2	22	1210	26.2	6.3	122	200
EZPV80606MTS	±10	60	35.0	56.0	57.5	52.5	20.3	1.2	22	1320	27.8	6.2	137	200
EZPV80656MTS	±10	65	35.0	64.5	57.5	52.5	20.3	1.2	22	1430	29.3	6.2	140	200

*1 : When rising temperature of capacitor surface by continuous peak current(included pulse current), use within limit specified for temperature of capacitor surface and self heating temperature rise.

*2 : Maximum RMS current @ 70°C , 10kHz Use within limit for self heating temperature rise at capacitor surface.

*3 : 20 °C、10 kHz

*4 : Minimum order quantity consists of 4 packing units.

Rating · Dimensions · Quantity

For automotive

■ Rated voltage [DC] : 1000 V

NEW

Part No.	Cap. Tol. (%)	Cap. (μF)	Dimensions (mm)						dv/dt (V/μs)	Permissible current		ESR ^{*3} (mΩ)	Mass (g)	Min. order Qty ^{*4} (PCS)
			W	H	L	P1	P2	∅		Peak current ^{*1} (A _{0-P})	RMS current ^{*2} (A rms)			
EZPV1A305LTT	±10	3	15.0	29.0	41.0	37.5	-	1.0	50	150	4.4	30.8	22	1200
EZPV1A405LTT	±10	4	15.0	29.0	41.0	37.5	-	1.0	50	200	5.5	23.5	23	1200
EZPV1A475LTT	±10	4.7	17.0	34.5	41.0	37.5	-	1.0	50	235	6.2	21.7	28	1200
EZPV1A505LTT	±10	5	17.0	34.5	41.0	37.5	-	1.0	50	250	6.5	20.4	28	1200
EZPV1A605LTT	±10	6	17.0	34.5	41.0	37.5	-	1.0	50	300	7.3	17.5	29	1200
EZPV1A705MTT	±10	7	22.0	36.0	41.0	37.5	10.2	1.0	50	350	8.5	15.5	39	600
EZPV1A805MTT	±10	8	22.0	36.0	41.0	37.5	10.2	1.0	50	400	9.5	13.7	41	600
EZPV1A905MTT	±10	9	22.0	36.0	41.0	37.5	10.2	1.0	50	450	10.4	12.4	42	600
EZPV1A106MTT	±10	10	23.5	43.5	41.5	37.5	10.2	1.0	50	500	11.2	12.7	48	400
EZPV1A126MTT	±10	12	26.0	40.5	41.0	37.5	10.2	1.0	50	600	12.8	10.4	55	600
EZPV1A156MTT	±10	15	30.0	50.5	41.0	37.5	10.2	1.0	50	750	15.0	10.4	70	400
EZPV1A186MTT	±10	18	30.0	50.5	41.0	37.5	20.3	1.0	50	900	16.9	8.5	74	400
EZPV1A206MTT	±10	20	30.0	56.0	41.5	37.5	20.3	1.2	50	1000	18.1	7.2	82	400
EZPV1A256MTT	±10	25	38.0	52.5	42.0	37.5	20.3	1.2	50	1250	20.9	5.9	108	400
EZPV1A306MTT	±10	30	43.0	58.0	41.0	37.5	20.3	1.2	50	1500	23.4	5.7	132	400
EZPV1A156MTS	±10	15	25.0	40.0	57.0	52.5	10.2	1.2	30	450	10.6	13.7	67	600
EZPV1A206MTS	±10	20	35.5	45.5	57.5	52.5	10.2	1.2	30	600	12.2	11.2	106	200
EZPV1A256MTS	±10	25	35.5	45.5	57.5	52.5	20.3	1.2	30	750	13.6	9.1	111	200
EZPV1A306MTS	±10	30	35.0	50.0	57.5	52.5	20.3	1.2	30	900	14.9	9.9	116	200
EZPV1A356MTS	±10	35	35.0	56.0	57.5	52.5	20.3	1.2	30	1050	16.1	9.2	132	200
EZPV1A406MTS	±10	40	35.0	56.0	57.5	52.5	20.3	1.2	30	1200	17.2	7.8	138	200

*1 : When rising temperature of capacitor surface by continuous peak current(included pulse current), use within limit specified for temperature of capacitor surface and self heating temperature rise.

*2 : Maximum RMS current @ 70°C , 10kHz Use within limit for self heating temperature rise at capacitor surface.

*3 : 20 °C、10 kHz

*4 : Minimum order quantity consists of 4 packing units.

Rating · Dimensions · Quantity

For automotive

■ Rated voltage [DC] : 1100 V

Part No.	Cap. Tol. (%)	Cap. (μF)	Dimensions (mm)						dv/dt (V/μs)	Permissible current		ESR ^{*3} (mΩ)	Mass (g)	Min. order Qty ^{*4} (PCS)
			W	H	L	P1	P2	∅		Peak current ^{*1} (A _{0-P})	RMS current ^{*2} (A rms)			
EZPV1B305LTT	±10	3	15.0	29.0	41.0	37.5	-	1.0	50	150	4.4	30.8	22	1200
EZPV1B405LTT	±10	4	15.0	29.0	41.0	37.5	-	1.0	50	200	5.5	23.5	23	1200
EZPV1B475LTT	±10	4.7	17.0	34.5	41.0	37.5	-	1.0	50	235	6.2	21.7	28	1200
EZPV1B505LTT	±10	5	17.0	34.5	41.0	37.5	-	1.0	50	250	6.5	20.4	28	1200
EZPV1B605LTT	±10	6	17.0	34.5	41.0	37.5	-	1.0	50	300	7.3	17.5	29	1200
EZPV1B705MTT	±10	7	22.0	36.0	41.0	37.5	10.2	1.0	50	350	8.5	15.5	39	600
EZPV1B805MTT	±10	8	22.0	36.0	41.0	37.5	10.2	1.0	50	400	9.5	13.7	41	600
EZPV1B905MTT	±10	9	22.0	36.0	41.0	37.5	10.2	1.0	50	450	10.4	12.4	42	600
EZPV1B106MTT	±10	10	23.5	43.5	41.5	37.5	10.2	1.0	50	500	11.2	12.7	48	400
EZPV1B126MTT	±10	12	26.0	40.5	41.0	37.5	10.2	1.0	50	600	12.8	10.4	55	600
EZPV1B156MTT	±10	15	30.0	50.5	41.0	37.5	10.2	1.0	50	750	15.0	10.4	70	400
EZPV1B186MTT	±10	18	30.0	50.5	41.0	37.5	20.3	1.0	50	900	16.9	8.5	74	400
EZPV1B206MTT	±10	20	30.0	56.0	41.5	37.5	20.3	1.2	50	1000	18.1	7.2	82	400
EZPV1B256MTT	±10	25	38.0	52.5	42.0	37.5	20.3	1.2	50	1250	20.9	5.9	108	400
EZPV1B306MTT	±10	30	43.0	58.0	41.0	37.5	20.3	1.2	50	1500	23.4	5.7	132	400
EZPV1B156MTS	±10	15	25.0	40.0	57.0	52.5	10.2	1.2	30	450	10.6	13.7	67	600
EZPV1B206MTS	±10	20	35.5	45.5	57.5	52.5	10.2	1.2	30	600	12.2	11.2	106	200
EZPV1B256MTS	±10	25	35.5	45.5	57.5	52.5	20.3	1.2	30	750	13.6	9.1	111	200
EZPV1B306MTS	±10	30	35.0	50.0	57.5	52.5	20.3	1.2	30	900	14.9	9.9	116	200
EZPV1B356MTS	±10	35	35.0	56.0	57.5	52.5	20.3	1.2	30	1050	16.1	9.2	132	200
EZPV1B406MTS	±10	40	35.0	56.0	57.5	52.5	20.3	1.2	30	1200	17.2	7.8	138	200

*1 : When rising temperature of capacitor surface by continuous peak current(included pulse current), use within limit specified for temperature of capacitor surface and self heating temperature rise.

*2 : Maximum RMS current @ 70°C , 10kHz Use within limit for self heating temperature rise at capacitor surface.

*3 : 20 °C、10 kHz

*4 : Minimum order quantity consists of 4 packing units.

Characteristics data

■ **Rated voltage [DC] : 600 V**

Electrical characteristics <Typical data >

Temperature characteristics

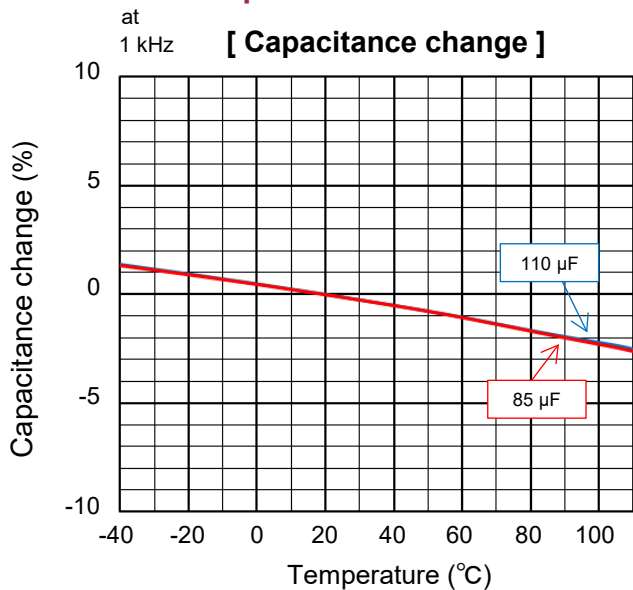

Frequency characteristics

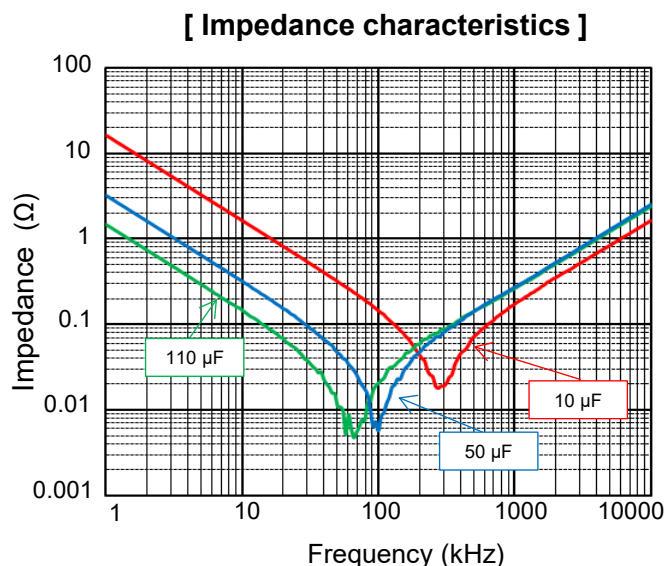
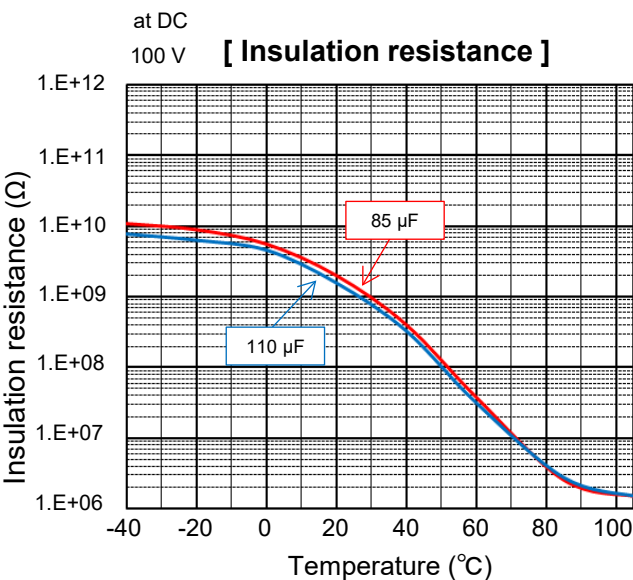
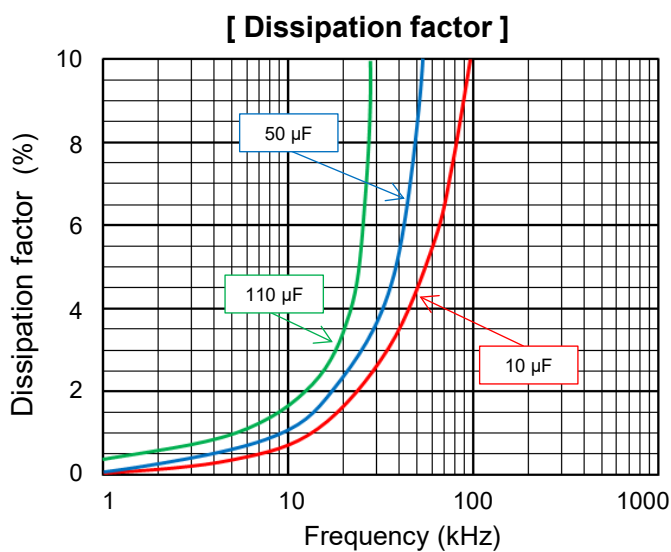
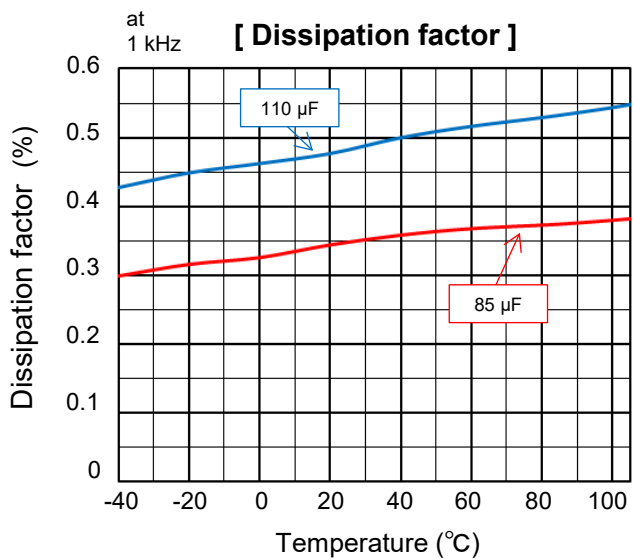
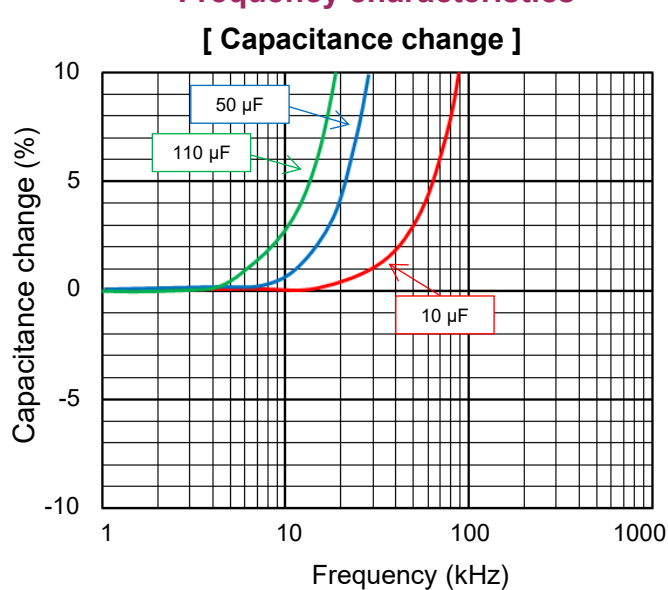

Characteristics data

■ Rated voltage [DC] : 600 V

Applicable specifications

[Permissible Current]

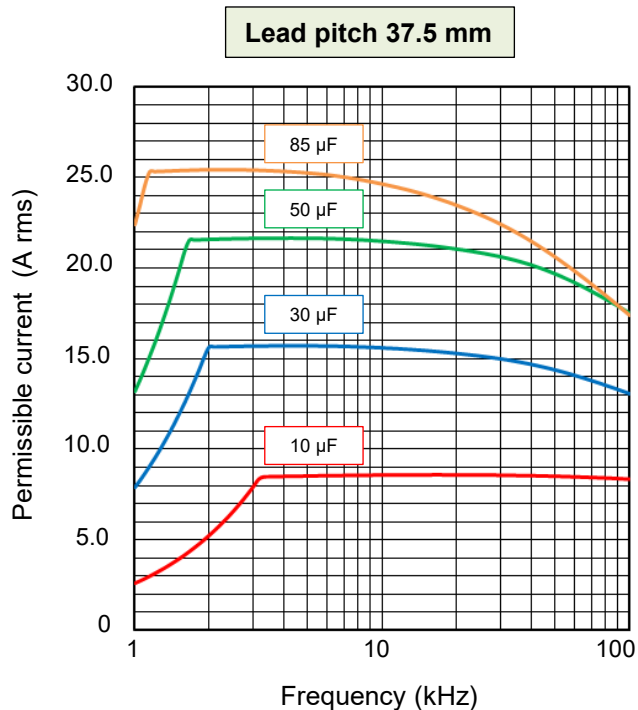

[Permissible Current Derating by Temperature]

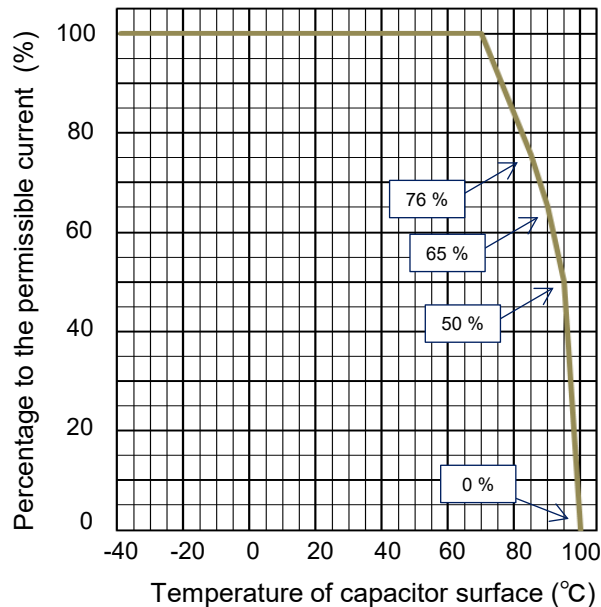

[Permissible Current]

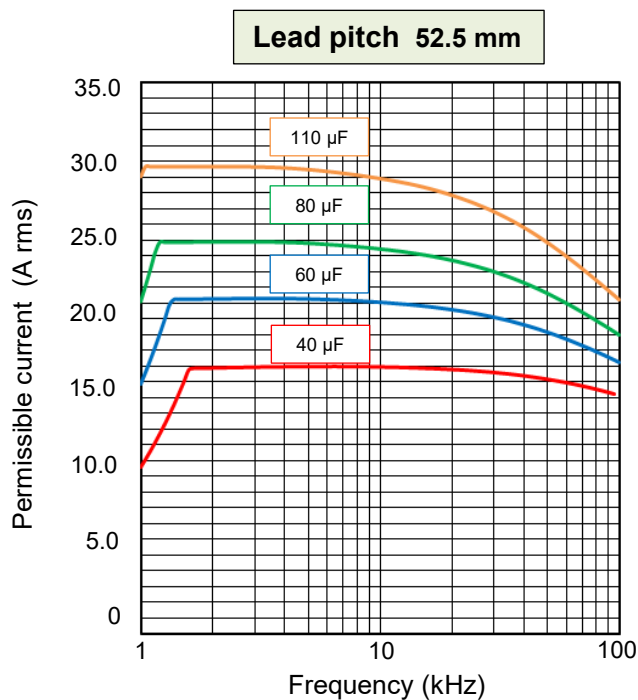

[Voltage Derating by Temperature]

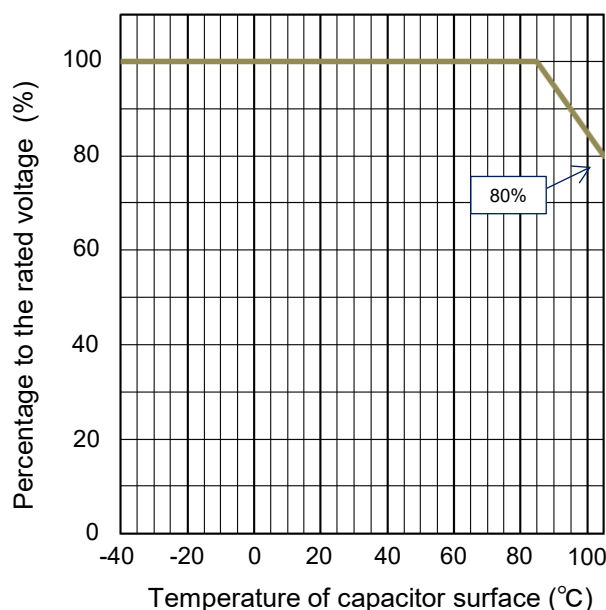

Permissible pulse current (dV/dt)
(Max. 10000 cycles)

R. voltage [DC] (V)	Pitch (mm)	Capacitance (µF)	Code	dV/dt (V/µs)	Current (Ao-p)
600	37.5	10.0	106	25	250.0
		30.0	306		750.0
		50.0	506		1250.0
		70.0	706		1750.0
		85.0	856		2125.0
	52.5	40.0	406	15	600.0
		60.0	606		900.0
		80.0	806		1200.0
		110.0	117		1650.0

Characteristics data

■ **Rated voltage [DC] : 700 V / 800 V (Lead pitch 27.5 mm)**

Electrical characteristics <Typical data >

Temperature characteristics

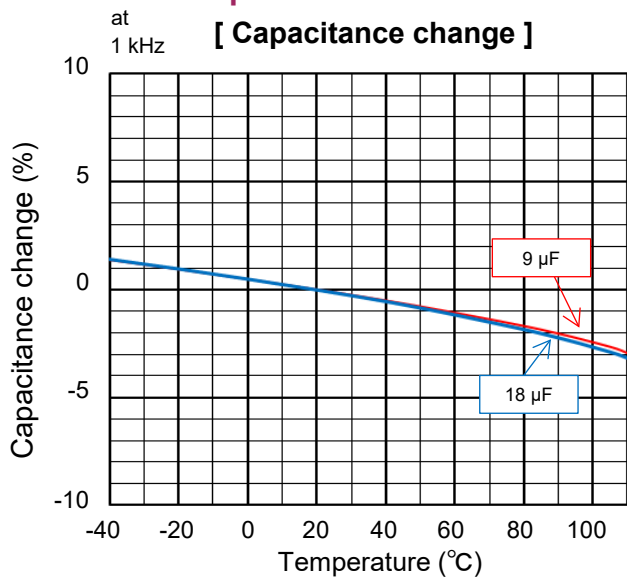

Frequency characteristics

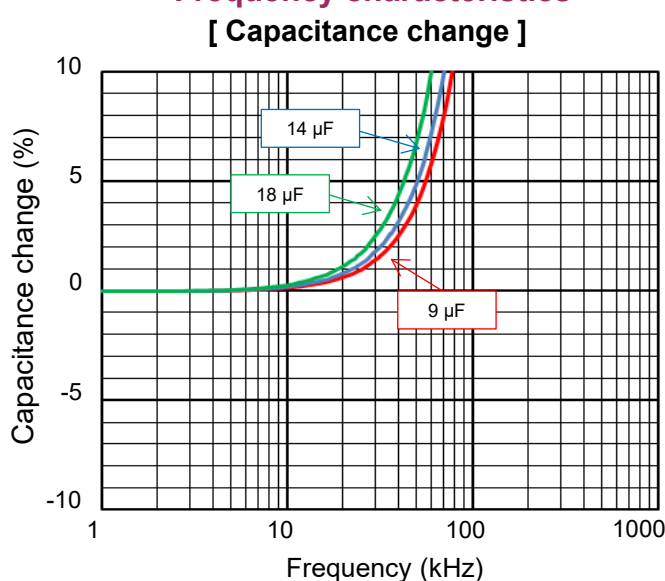

at 1 kHz [Dissipation factor]

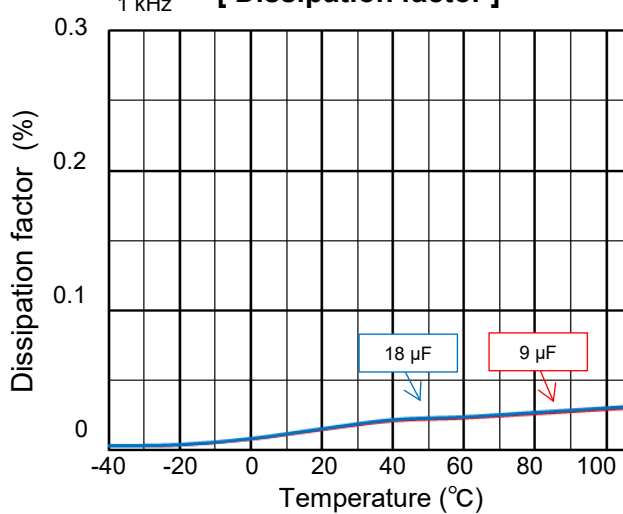

[Dissipation factor]

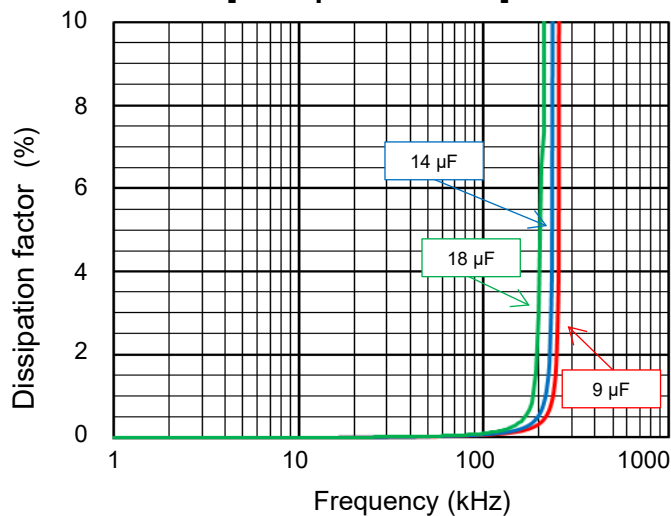

at DC 100 V [Insulation resistance]

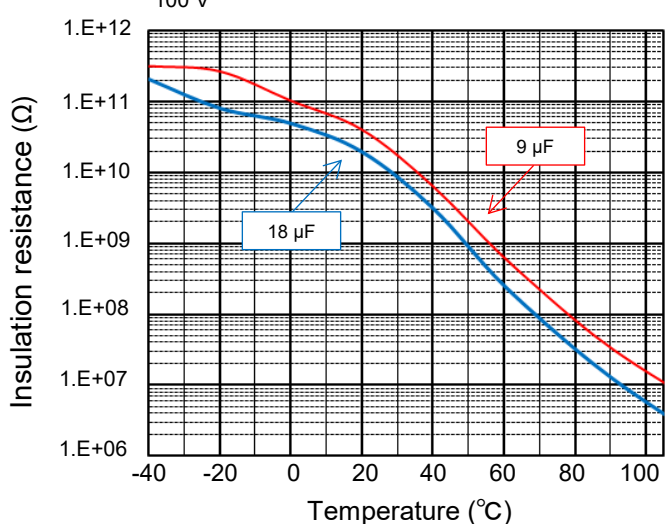

[Impedance characteristics]

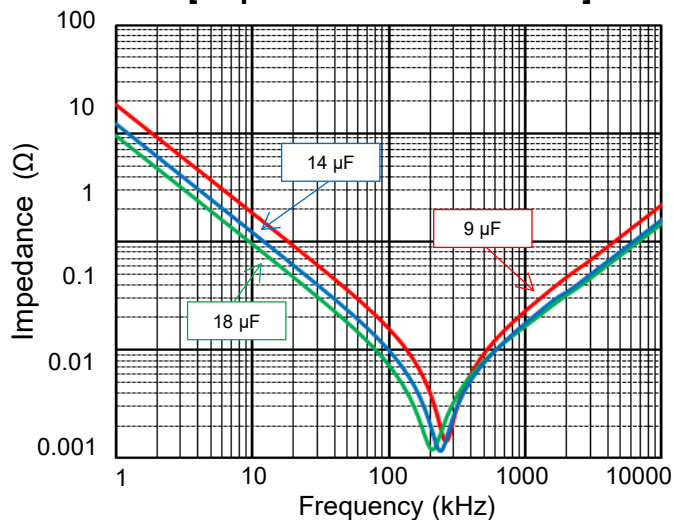

Characteristics data

■ **Rated voltage [DC] : 700 V / 800 V (Lead pitch 27.5 mm)**

Applicable specifications

[Permissible Current]

Lead pitch 27.5 mm

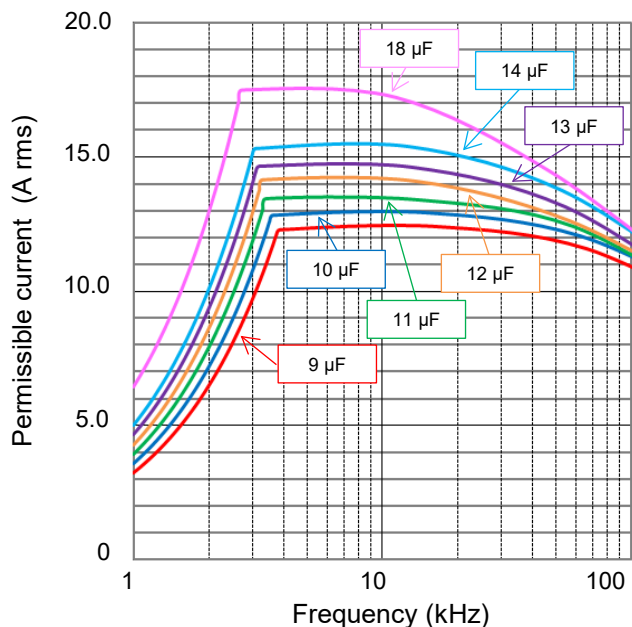

[Permissible Current Derating by Temperature]

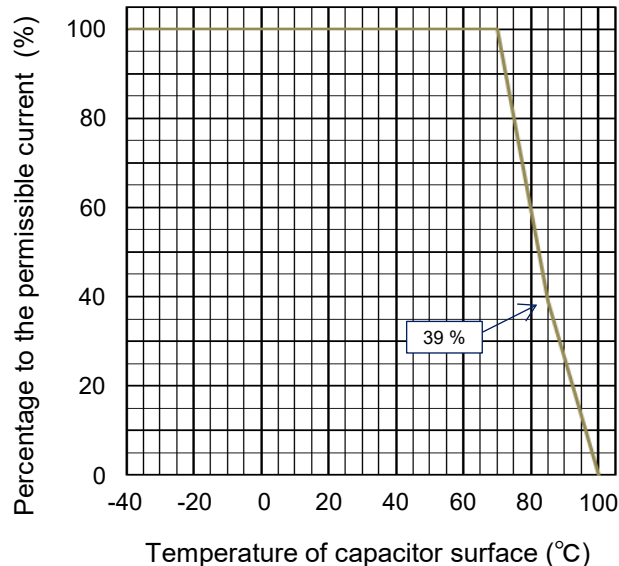

[Voltage Derating by Temperature]

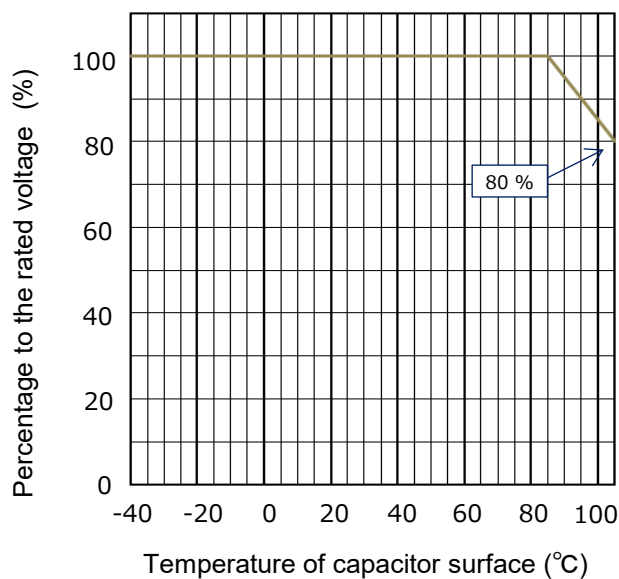

Permissible pulse current (dV/dt)
(Max. 10000 cycles)

R. voltage [DC] (V)	Pitch (mm)	Capacitance (µF)	Code	dV/dt (V/µs)	Current (A _{o-p})
700 / 800	27.5	9.0	905	35	315.0
		10.0	106		350.0
		11.0	116		385.0
		12.0	126		420.0
		13.0	136		455.0
		14.0	146		490.0
		18.0	186		630.0

Characteristics data

■ **Rated voltage [DC] : 700 V / 800 V (Lead pitch 37.5 / 52.5 mm)**

Electrical characteristics <Typical data >

Temperature characteristics

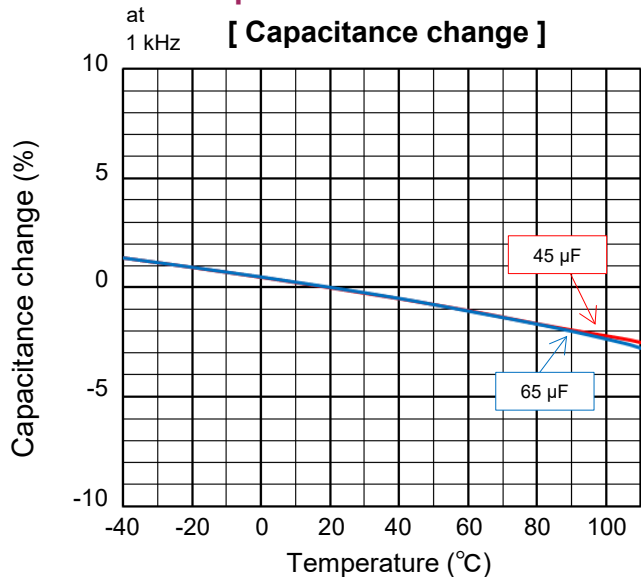

Frequency characteristics

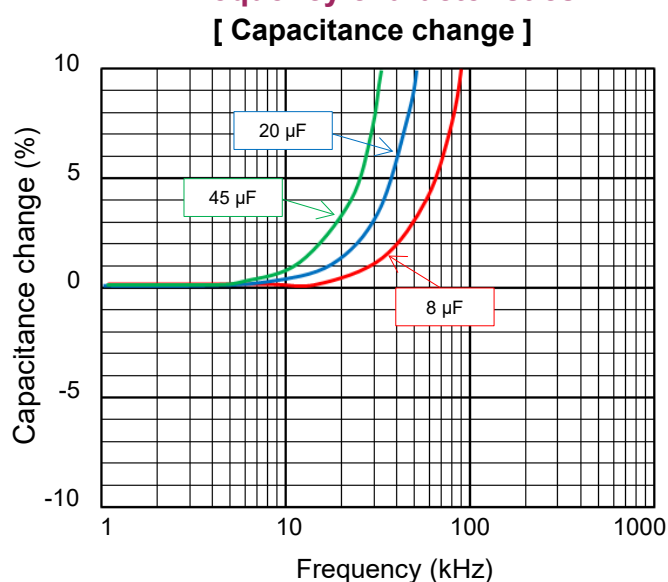

at 1 kHz [Dissipation factor]

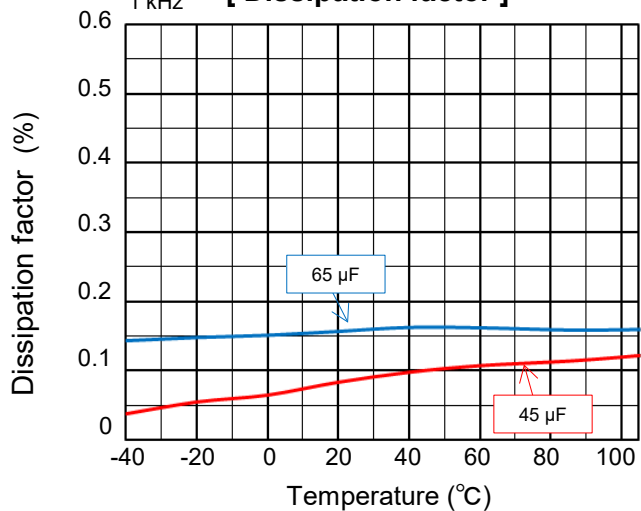

[Dissipation factor]

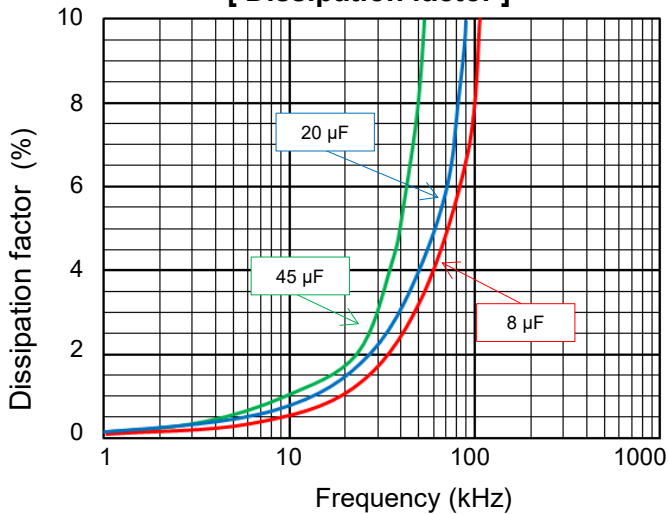

at DC 100 V [Insulation resistance]

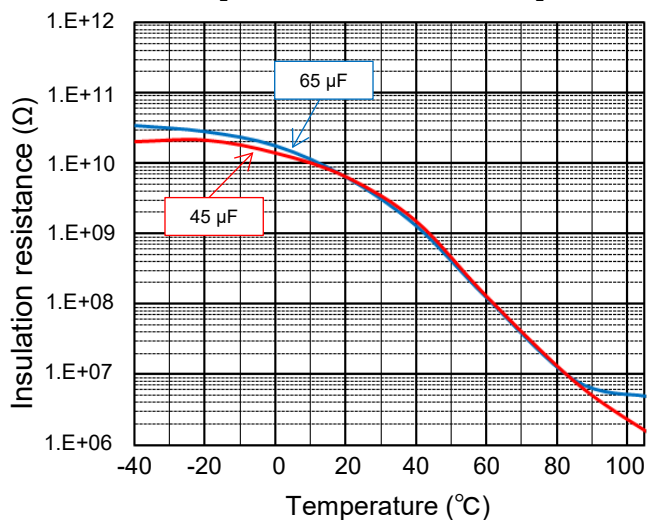

[Impedance characteristics]

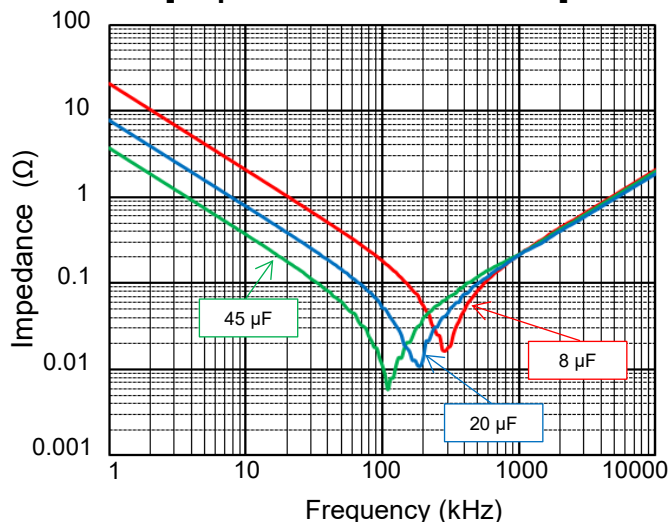

Characteristics data

■ **Rated voltage [DC] : 700 V / 800 V (Lead pitch 37.5 / 52.5 mm)**

Applicable specifications

[Permissible Current]

Lead pitch 37.5 mm

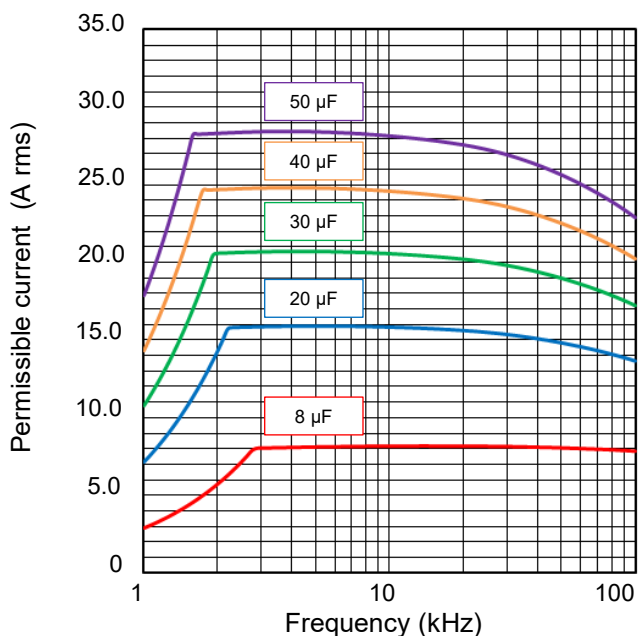

[Permissible Current Derating by Temperature]

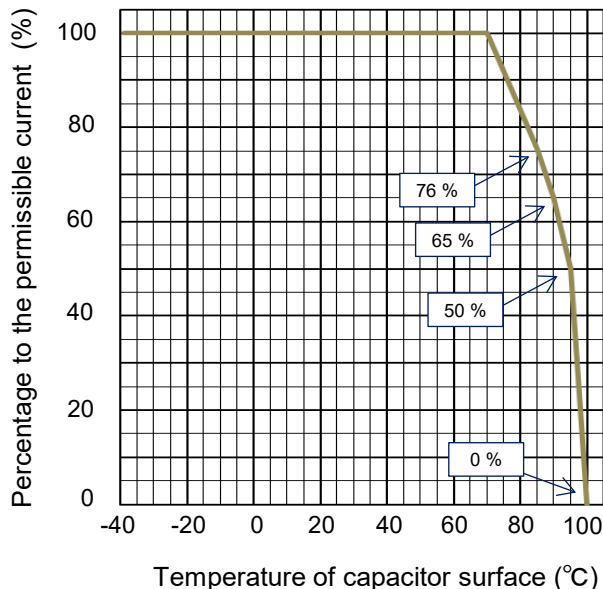

[Permissible Current]

Lead pitch 52.5 mm

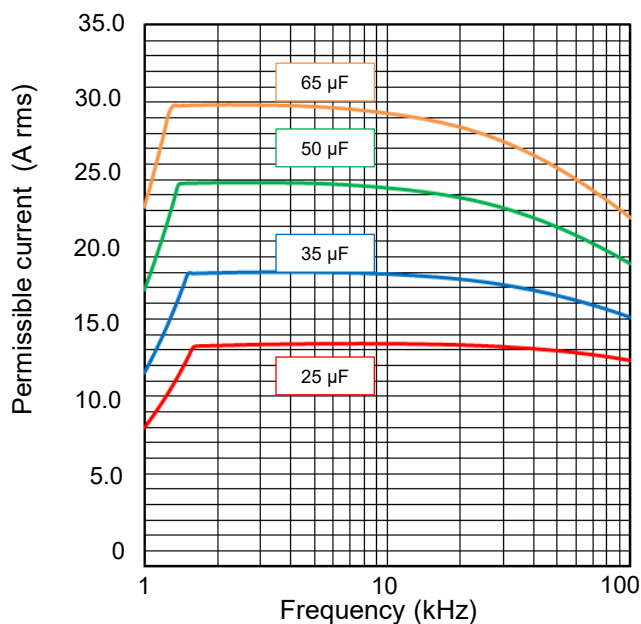

[Voltage Derating by Temperature]

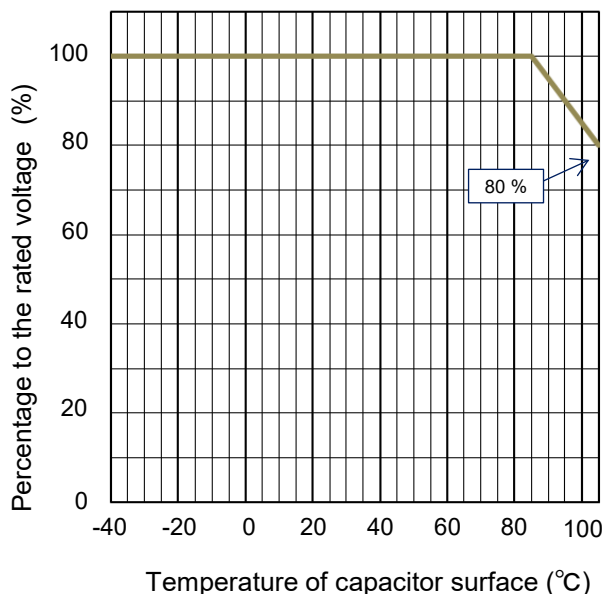

**Permissible pulse current (dV/dt)
(Max. 10000 cycles)**

R. voltage [DC] (V)	Pitch (mm)	Capacitance (μF)	Code	dV/dt (V/μs)	Current (A _{o-p})
700 / 800	37.5	8.0	805	35	280.0
		20.0	206		700.0
		30.0	306		1050.0
		40.0	406		1400.0
		50.0	506		1750.0
	52.5	25.0	256	22	550.0
		35.0	356		770.0
		50.0	506		1100.0
		65.0	656		1430.0

Characteristics data

■ **Rated voltage [DC] : 1000 V / 1100 V**

Electrical characteristics <Typical data >

Temperature characteristics

at 1 kHz [Capacitance change]

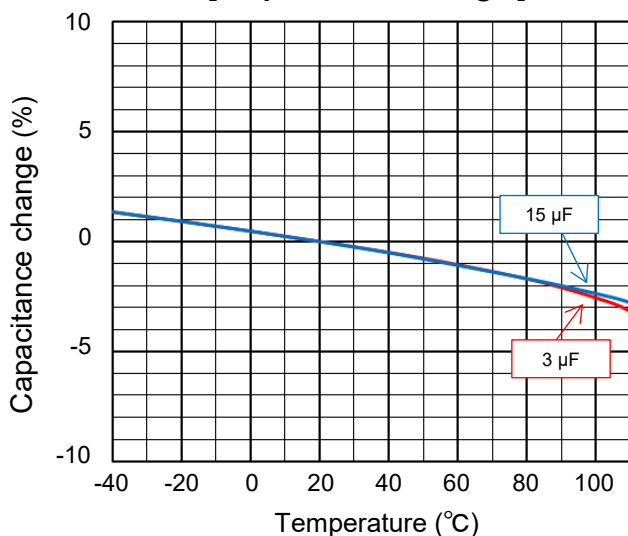

Frequency characteristics

[Capacitance change]

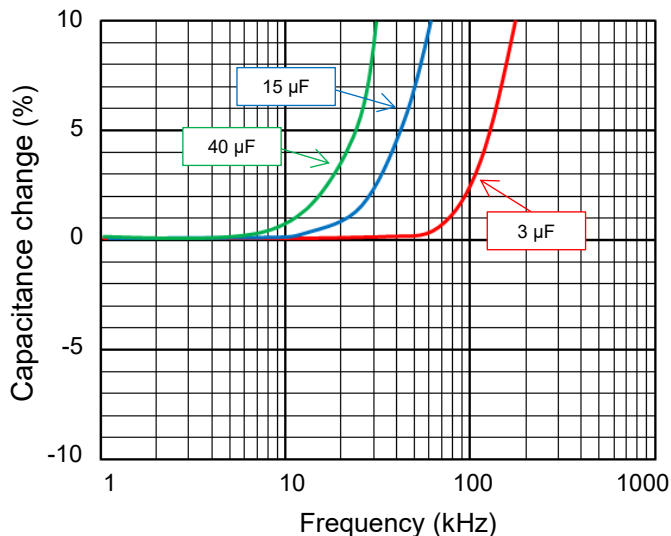

at 1 kHz [Dissipation factor]

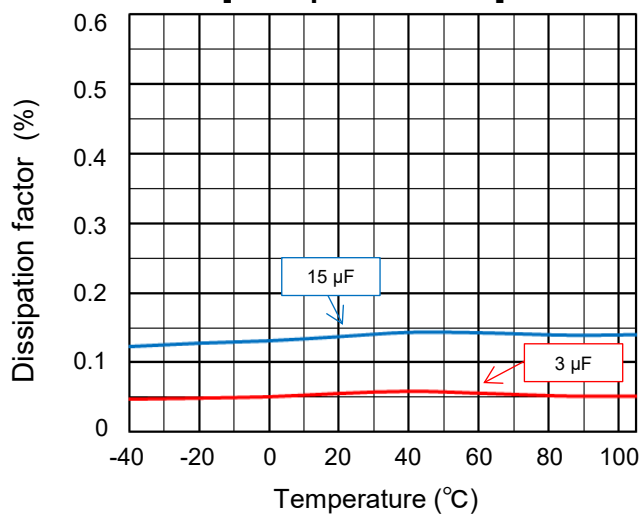

[Dissipation factor]

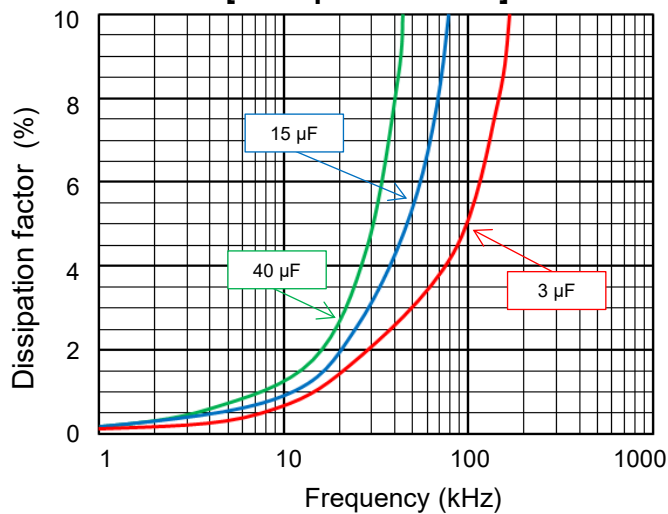

at DC 100 V [Insulation resistance]

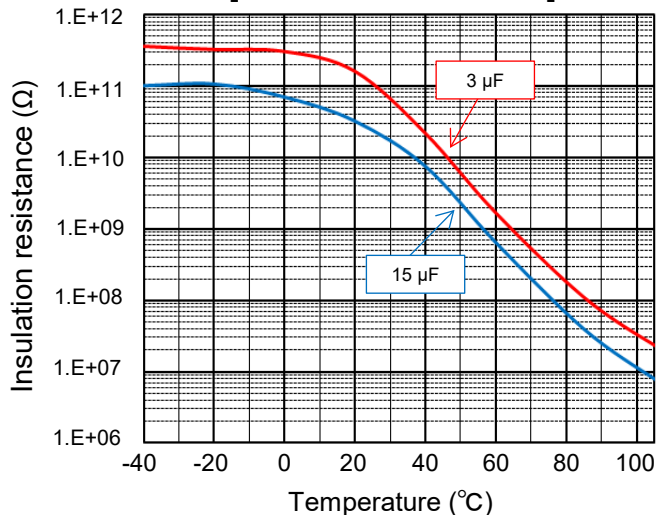

[Impedance characteristics]

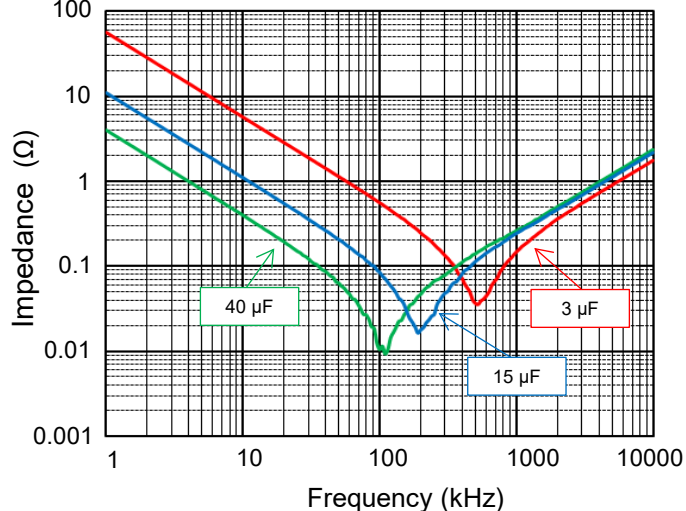

Characteristics data

■ **Rated voltage [DC] : 1000 V / 1100 V**

Applicable specifications

[Permissible Current]

Lead pitch 37.5 mm

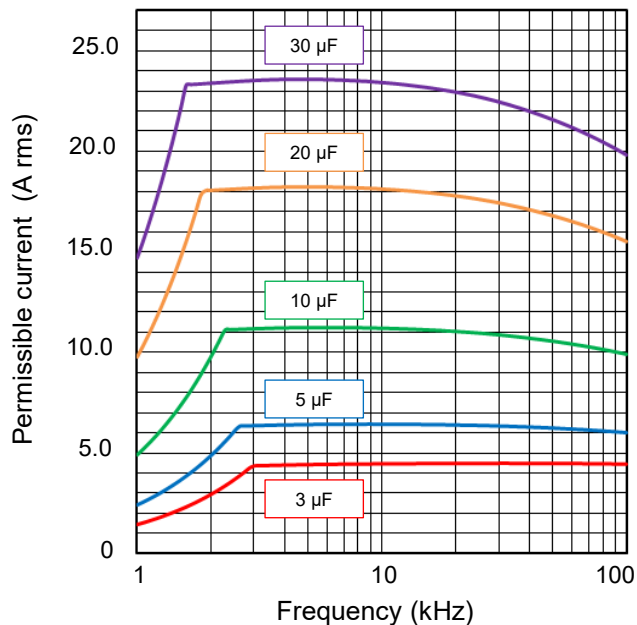

[Permissible Current Derating by Temperature]

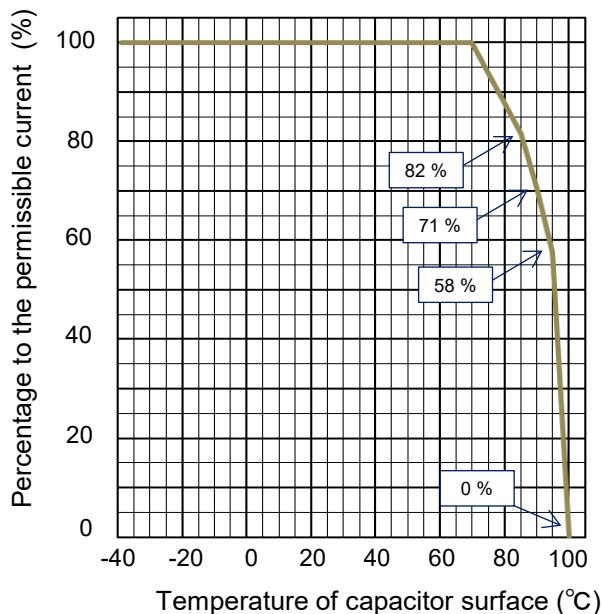

[Permissible Current]

Lead pitch 52.5 mm

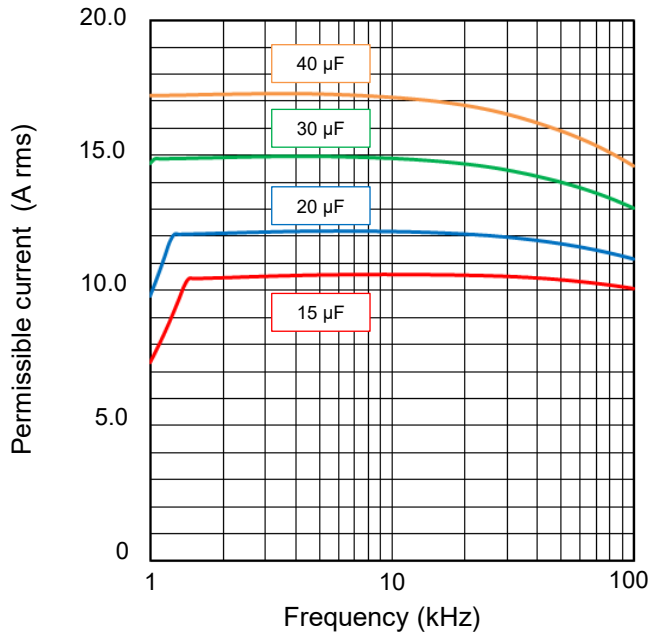

[Voltage Derating by Temperature]

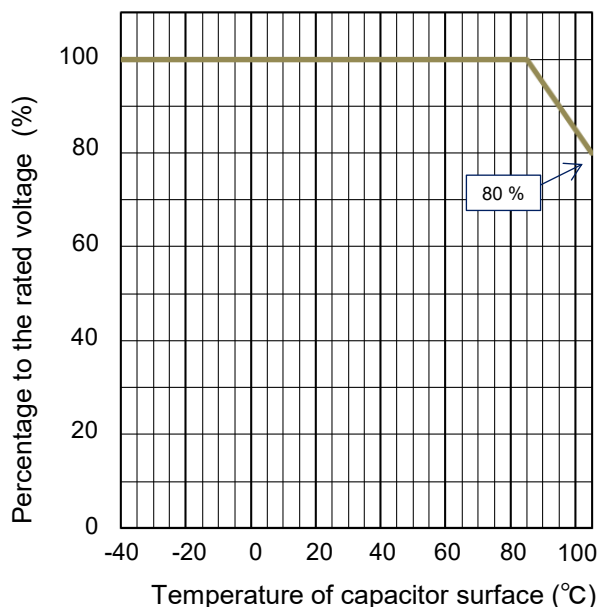

Permissible pulse current (dV/dt)
(Max. 10000 cycles)

R. voltage [DC] (V)	Pitch (mm)	Capacitance (μF)	Code	dV/dt (V/μs)	Current (A _{o-p})
1000 / 1100	37.5	3.0	305	50	150.0
		5.0	505		250.0
		10.0	106		500.0
		20.0	206		1000.0
		30.0	306		1500.0
	52.5	15.0	156	30	450.0
		20.0	206		600.0
		30.0	306		900.0
		40.0	406		1200.0

Safety Precautions

When using our products, no matter what sort of equipment they might be used for, be sure to confirm the applications and environmental conditions with our specifications in advance.

Panasonic
INDUSTRY

Panasonic Industry Co., Ltd.
Device Solutions Business Division

1006 Kadoma, Kadoma City, Osaka
571-8506 Japan