



Expertise Applied | Answers Delivered

AEC-Q200 Specification for Automotive Applications



Automotive

Users must independently evaluate the suitability of and test each product selected for their own specific applications. It is the User's sole responsibility to determine fitness for a particular system or use based on their own performance criteria, conditions, specific application, compatibility with other parts, and environmental conditions. Users must independently provide appropriate design and operating safeguards to minimize any risks associated with their applications and products. Littelfuse products are not designed for, and may not be used in, all applications. Read complete Disclaimer Notice at littelfuse.com/disclaimer-electronics.

Littelfuse has a long history of defining safety needs and developing components for automobiles

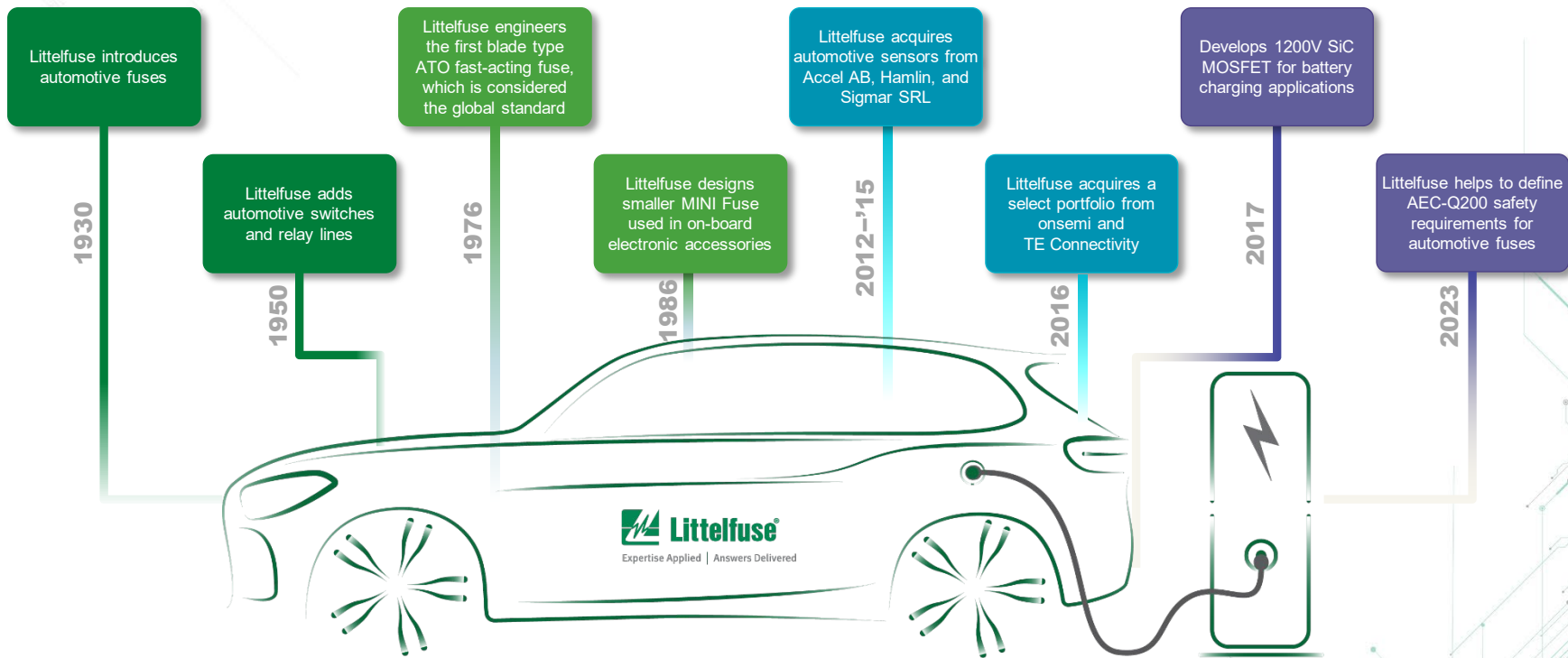

Littelfuse has contributed to the development of the **AEC-Q200 Rev E Standard** released in March 2023

Advanced electronics are driving innovation in multiple automotive applications

Infotainment & communication

- Smart infotainment
- Navigation
- Multipurpose camera
- Telematics box



Network systems & body electronics

- CAN, LIN
- USB, Wireless
- Keyless entry
- Lighting control



Advanced Driver Assistance System

- V2X Communication
- Radar
- eCall
- Sensor fusion



Power train

- Battery management system
- On-board charger
- Traction motor inverter
- DC-DC converter

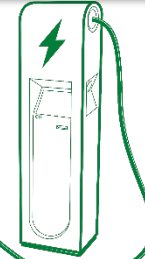

Chassis and safety system

- Seatbelt safety
- Tire pressure monitoring
- Battery disconnect
- Fuel level detection

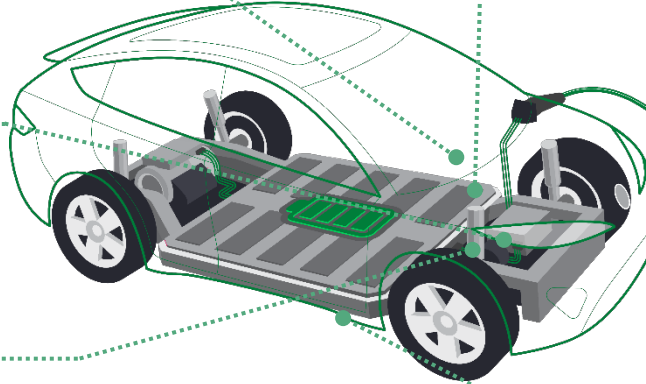

We satisfy the need for reliable, high-quality circuit protection products for safety and reliability



Introduction to Automotive Electronics Council (AEC)

Body for establishing standards for reliable, high quality electronic components

Key highlights

The Automotive Electronics Council (AEC) was originally established in the 1990s by Chrysler, Ford, and GM to establish common part-qualification and quality-system standards.

From its inception, the AEC has consisted of two committees: the Quality Systems Committee and the Component Technical Committee.

Components meeting the specifications listed by the Component Technical Committee are suitable for harsh automotive environments.

Different AEC-Q Standards:

- **AEC-Q100**–Failure Mechanism-Based Stress Test Qualification for Integrated Circuits
- **AEC-Q101**–Failure Mechanism-Based Stress Test Qualification for Discrete Semiconductors
- **AEC - Q102**–Failure Mechanism-Based Stress Test Qualification for Discrete Optoelectronic Semiconductors in Automotive Applications
- **AEC - Q103**–Failure Mechanism-Based Stress Test Qualification for Sensors in Automotive Applications
- **AEC - Q104**–Failure Mechanism-Based Stress Test Qualification for Multichip Modules (MCM) In Automotive Applications
- **AEC-Q200**–Stress Test Qualification for Passive Components

Proliferation of electronics in today's vehicles

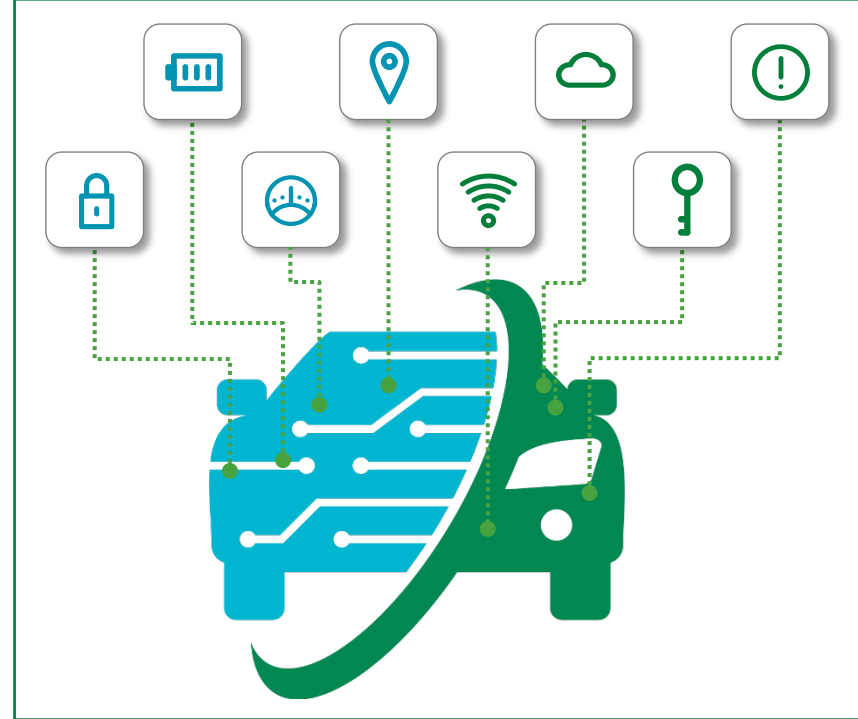

AEC-Q200 Rev D: Stress test qualification for passives

Resistor, capacitor, inductor, transformer, resonator, crystal, PTC, NTC, thermistor, and varistor

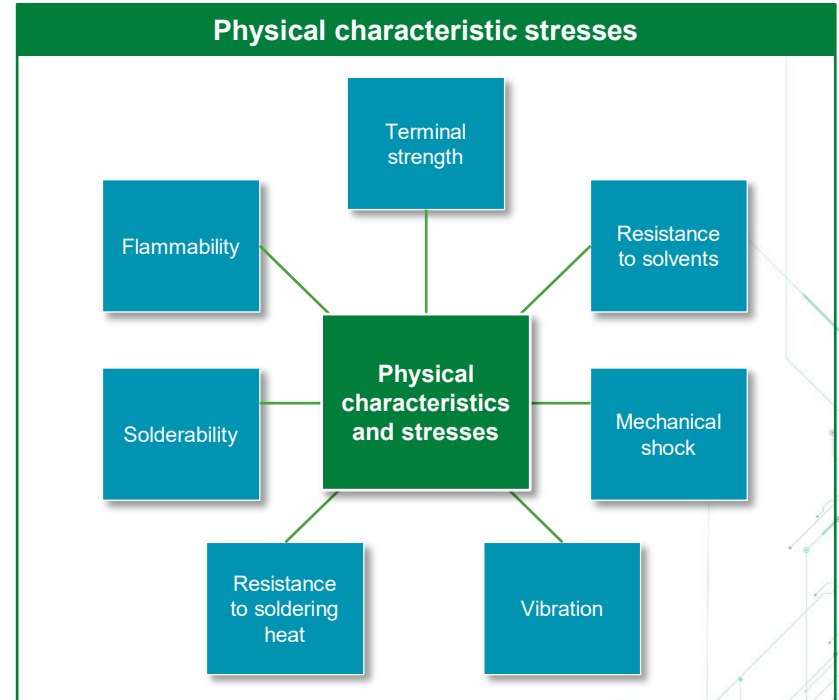
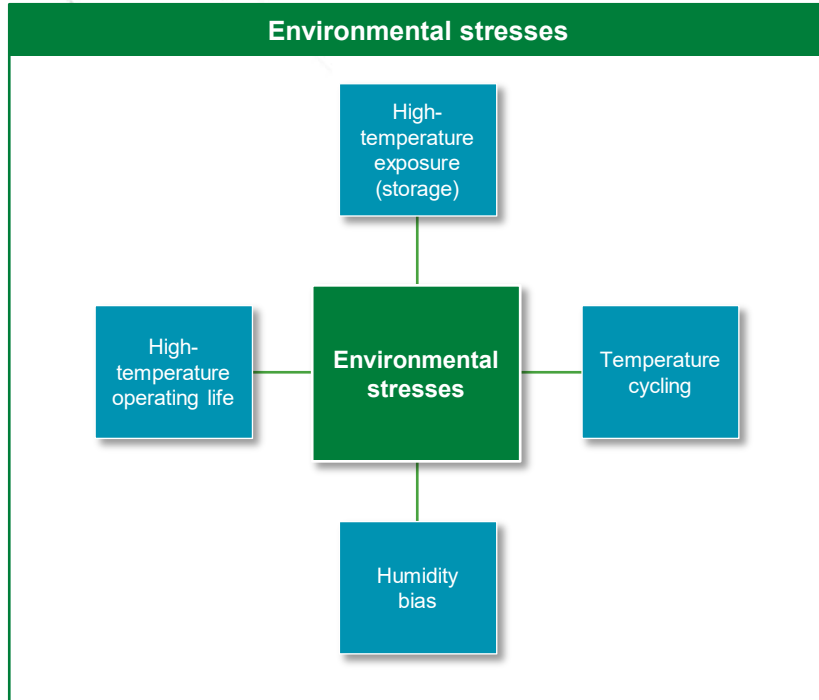

Two main tests: Environment stresses and physical characteristics stresses

New AEC-Q200 Rev E (released on March 20, 2023) adds reliability qualifications for fuses

Key highlights

The AEC-Q200 Rev E expands its scope to provide a single standard that manufacturers can use to design and test fuses for the automotive market.

Fuses provide necessary overcurrent protection for all the circuits in a vehicle, and fuses should meet the rigorous standards for use in automotive equipment that other passive components must meet.

Littelfuse has contributed to the development of Revision E and the framework for defining the test requirements for fuses.

Design engineers developing systems for automotive vehicles will be able to select AEC-Q200 Qualified fuses that have been subjected to an extensive set of tests to ensure a rugged and reliable product.

AEC-Q200 E qualification fuse stress tests

Stress	No.	Reference
Pre- and post-stress electrical test	1	UL 248, IEC 60127, or User Specification
High-temperature exposure (storage)	3	MIL-STD-202, Method 108
Temperature cycling	4	JESD22-A104
Humidity bias	7	MIL-STD-202, Method 103
High-temperature operating life	8	MIL-STD-202, Method 108
External visual	9	MIL-STD-883, Method 2009
Physical dimensions	10	JESD22-B100
Terminal strength (for axial and radial THT components)	11	MIL-STD-202, Method 211
Resistance to solvents	12	MIL-STD-202, Method 215
Mechanical shock	13	MIL-STD-202, Method 213
Vibration	14	MIL-STD-202, Method 204
Resistance to soldering heat	15	MIL-STD-202, Method 210
Solderability	18	J-STD-002
Electrical characterization	19	UL 248, IEC 60127, or User Specification
Flammability	20	UL 94 or IEC 60695-11-5
Board Flex (SMD)	21	AEC-Q200-005
Terminal strength (SMD)	22	AEC-Q200-006

AEC-Q200 test plan vs. typical validation test plan

AEC-Q200

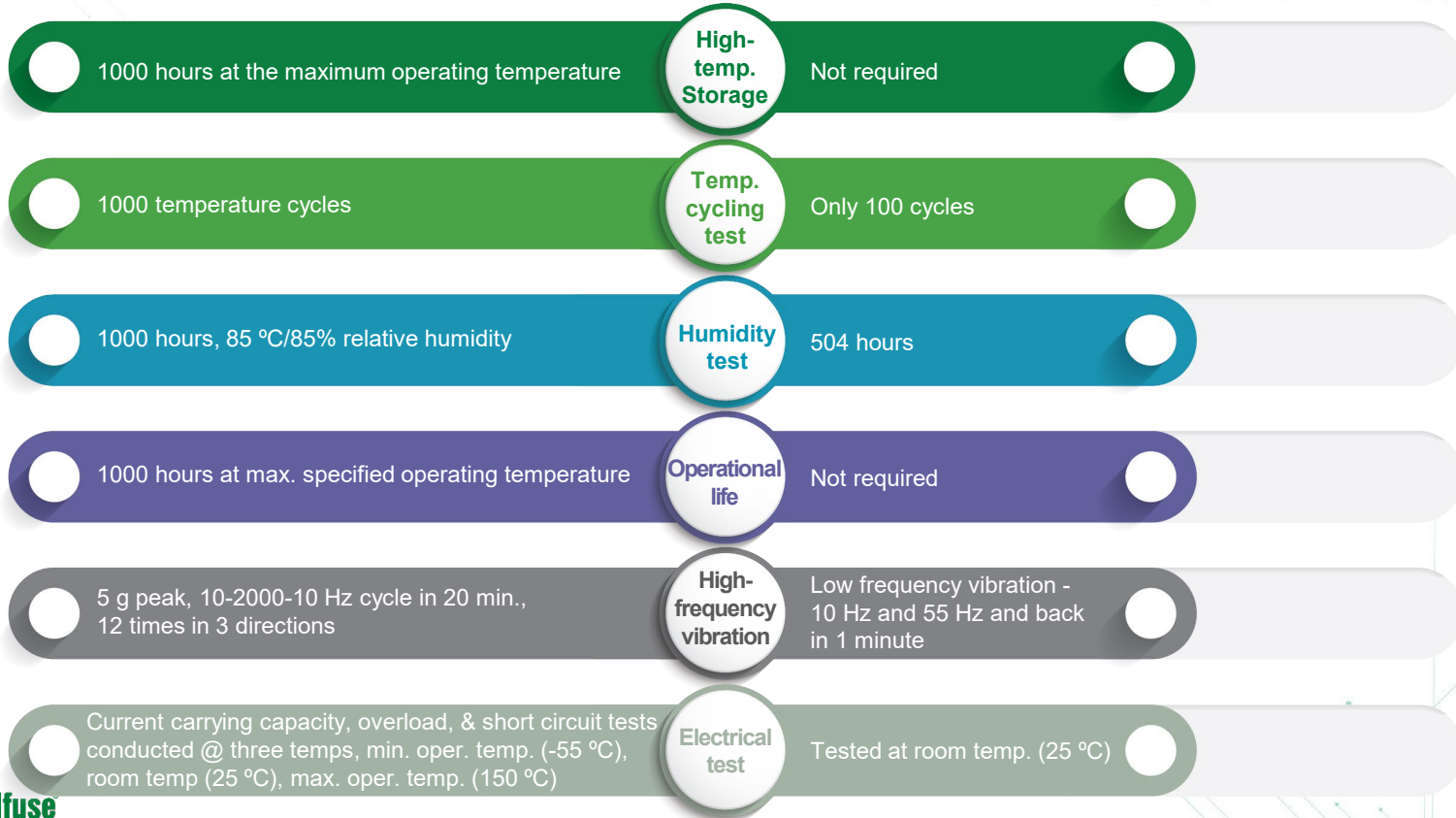

Typical

Littelfuse internal qualification tests were already aligned with the AEC-Q200 Rev. E

Internal test results in the datasheet

Materials	Body: Epoxy Resin Terminations: Cu/Ni/Sn (100% Pb-free)
Product Marking	Body: Current Rating
Operating Temperature	-55 °C to +125 °C
Solderability	MIL-STD-202
Thermal Shock	MIL-STD-202, Method 107, Test Condition B, 5 cycles, -65 °C to 125 °C, 15 minutes @ each extreme
Mechanical Shock	MIL-STD-202, Method 213B, Test Condition I: De-energized. 100 Gs peak amplitude, sawtooth wave 6 ms duration, 3 cycles XYZ+xyz = 18 shocks
Vibration	MIL-STD-202, Method 201: 0.03" amplitude, 10–55 Hz in 1 min. 2 hrs. each XYZ = 6 hrs (10–55 Hz)
Moisture Resistance	MIL-STD-202, Method 106, 10 cycles Condition A
Salt Spray	MIL-STD-202, Method 101, Test Condition B (48 hrs)
Resistance to Soldering Heat	Method 210, Test Condition B (10 sec at 260 °C)

483A Series Datasheet

Product Characteristics

Materials	Body: Epoxy Resin Terminations: Cu/Ni/Sn (100% Pb-free)
Product Marking	Body: Current Rating
Operating Temperature	-55 °C to +125 °C
Solderability	MIL-STD-202
Thermal Shock	MIL-STD-202, Method 107, Test Condition B, 5 cycles, -65 °C to 125 °C, 15 minutes @ each extreme
Mechanical Shock	MIL-STD-202, Method 213B, Test Condition I: De-energized. 100G's peak amplitude, sawtooth wave 6 ms duration, 3 cycles XYZ+xyz = 18 shocks
Vibration	MIL-STD-202, Method 201: 0.03" amplitude, 10–55 Hz in 1 min. 2 hrs. each XYZ = 6 hrs (10- 55 Hz)
Moisture Resistance	MIL-STD-202, Method 106, 10 cycles Condition A
Salt Spray	MIL-STD-202, Method 101, Test Condition B (48 hrs)
Resistance to Soldering Heat	Method 210, Test Condition B (10 sec at 260 °C)



Littelfuse is one of the first suppliers of AEC-Q200 Qualified fuses

Littelfuse invents the FIRST automotive fuse in 1930



Member of the AEC Technical Committee



First to market with AEC-Q200 Qualified fuses



Global manufacturing facilities certified ISO 9001, ISO 14001, and IATF 16949



Contributed to the development of Revision E



Internal qualification aligned with the new AEC-Q200 requirement



Wide array of AEC-Q100, AEC-Q101, and AEC-Q200 components to choose from



Application expertise



Littelfuse AEC-Q200 Qualified fuse portfolio

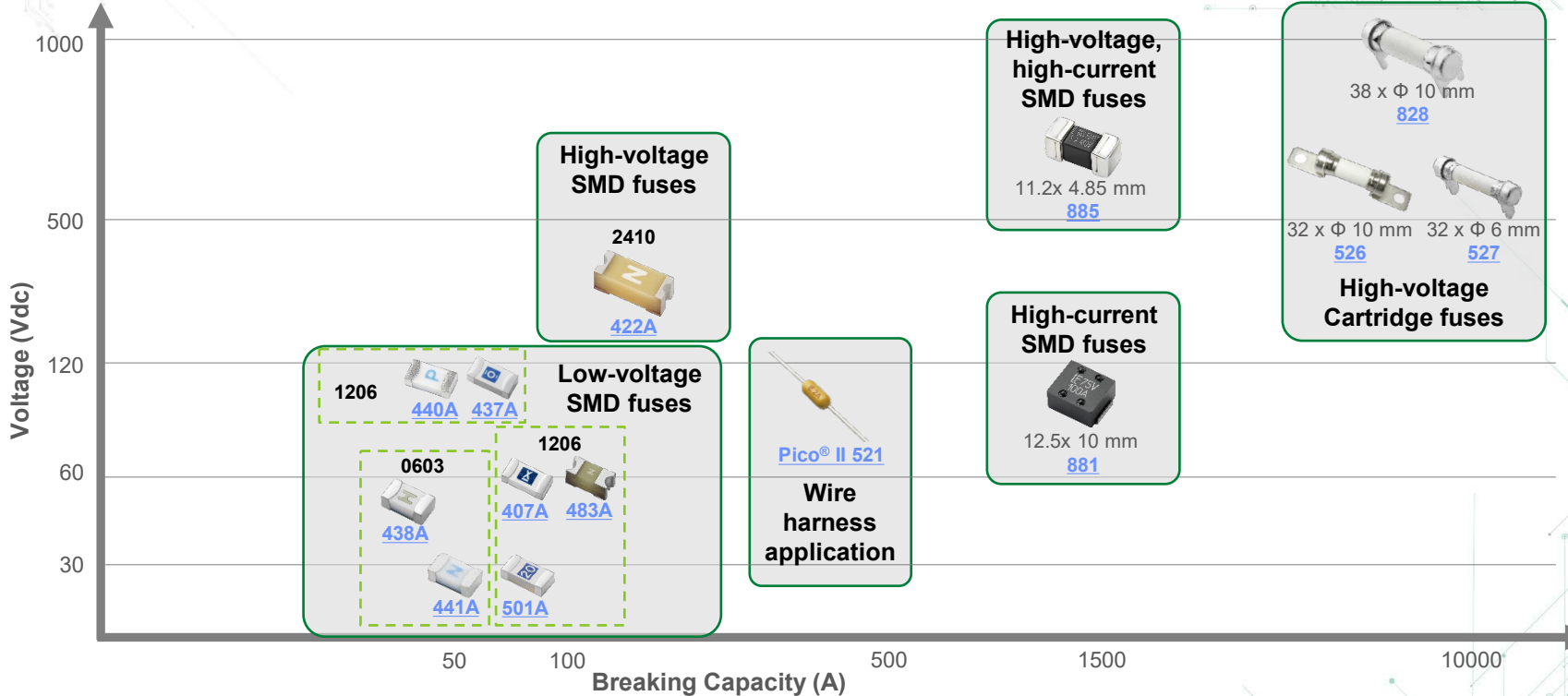

To learn more about Littelfuse's AEC-Q200 Qualified fuses portfolio, click [here](#)

AEC-Q200 Qualified fuses in automotive applications

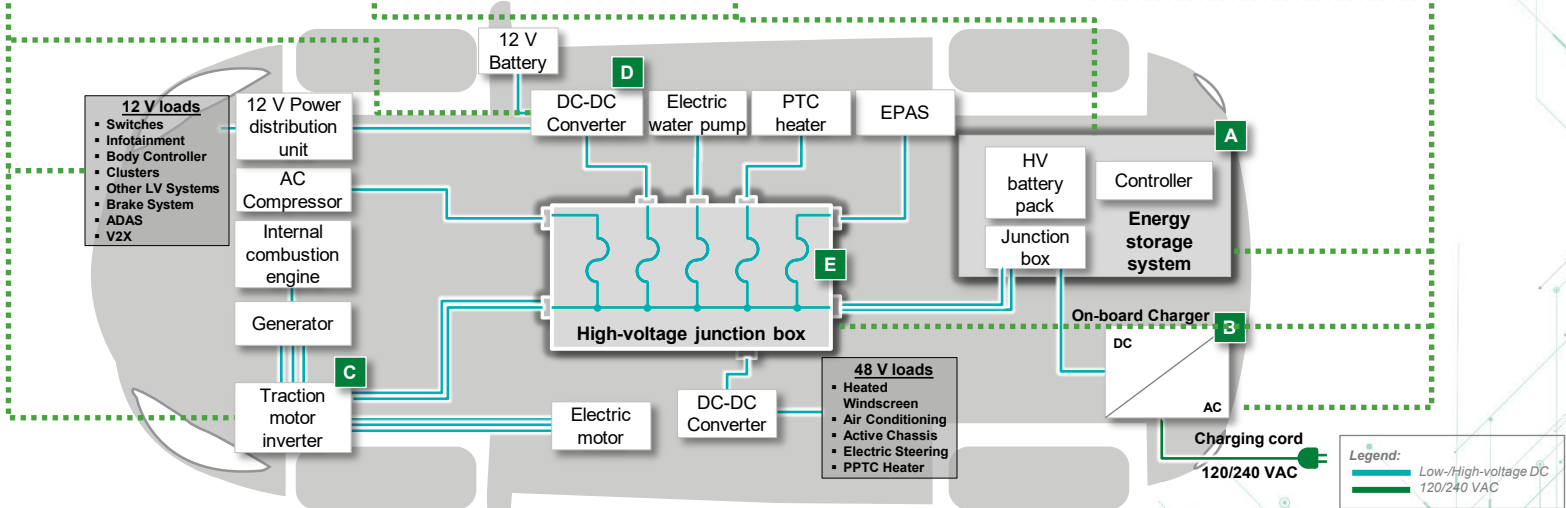
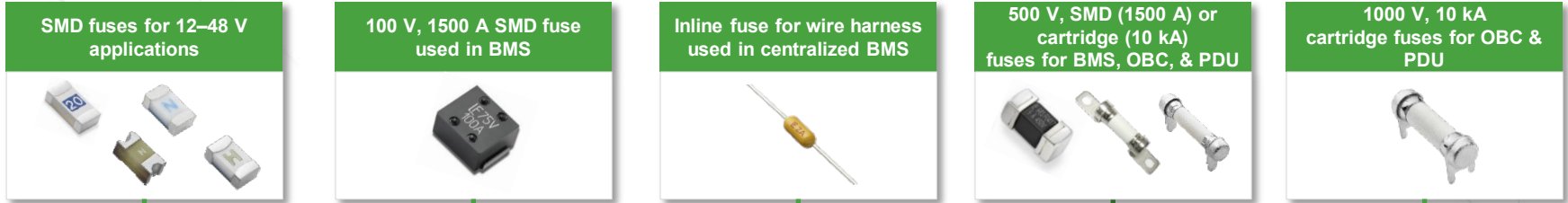

Additional information can be found on [Littelfuse.com](https://www.littelfuse.com)

Explore the world of Littelfuse with the electronics eCatalogs (ecatalogs.littelfuse.com)

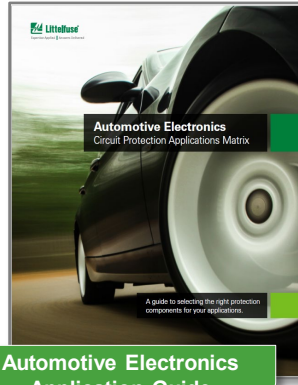
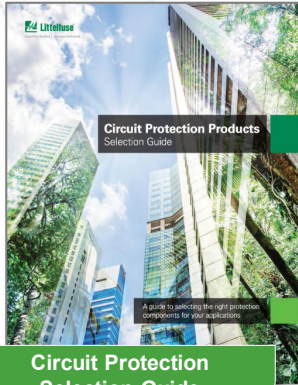

Click on images for more information

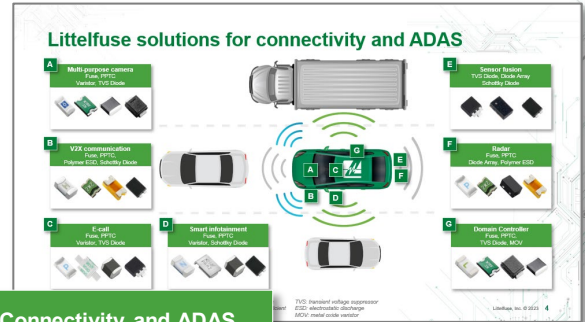
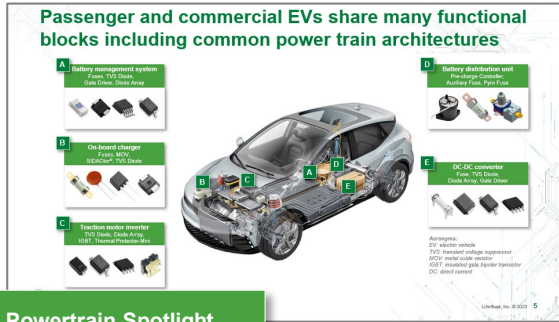

Local resources supporting our global customers



Legend

- Sales
- R&D
- Manufacturing

Your partner for tomorrow's electronic systems

Broad product portfolio

We are an industrial technology manufacturing company empowering a sustainable, connected, and safer world

Application expertise

Our engineers partner directly with customers to help speed up product design and meet unique needs

Global customer service

Our global customer service team will work with you to anticipate your needs and ensure a seamless experience

Compliance & regulatory expertise

We help customers in the design process to account for requirements set by global regulatory authorities

Testing capabilities

We help customers get products to market faster and offer certification testing to global regulatory standards

Global manufacturing

We offer high-quality manufacturing that is committed to the highest quality standards





Expertise Applied | Answers Delivered



[Littelfuse.com](https://www.littelfuse.com)



Expertise Applied | Answers Delivered

Supplementary slides



AEC-Q200 Qualified cartridge fuse portfolio

Parameter	828	526	527
Product Photo			
Footprint/Height	38 x ϕ 10 mm	32 x ϕ 10 mm	32 x ϕ 6 mm
Voltage Rating	1000 VDC	500 VAC/VDC	500 VAC
Interrupting Rating	10 kA @ 1000 VDC	10 kA @ 500 VAC/VDC	10 kA @ 500 VAC
Amperage Rating	15 A ~ 30 A	30–60 A	30–50 A
Operating Temperature	-55 °C to +125 °C	-55 °C to +125 °C	-55 °C to 125 °C

Key highlights

- AEC-Q200 Qualified
- Rated from 500 VDC/VAC–1000 VDC with an interrupting rating of 10 kA and 15–60 A nominal current rating in a small package
- Compact body size (6 x 32 mm, 10 x 32 mm, 10 x 38 mm)

AEC-Q200 Qualified high-current surface mount fuses

Parameter	885	881
Product Photo		
Footprint/Height	10.86 mm x 4.78 mm	12.5 mm x 10 mm
Voltage Rating	500 VDC	100 VDC
Interrupting Rating	1500 A @ 350 VDC	1500A @ 75VDC
Amperage Rating	1 A–5 A	60A ~ 100A
Operating Temperature	-55 °C to 105 °C	-55 °C to 100 °C

Key highlights

- AEC-Q200 Qualified
- High DC voltage up to 500 VDC and interrupting current rating up to 1500 A
- Compact body size (10.86 x 4.78mm)

AEC-Q200 Qualified surface mount thin film chip fuses

Parameter	441A	501A	407A	438A	440A	483A	437A	422A
Product photo								
Footprint/ height	0603	1206	1206	0603	1206	1206	1206	2410
Voltage rating	32 VDC	32 VDC	24–63 VDC	24–63 VDC	50–125 VDC	75 VAC/VDC	32–125 VDC	125–250 VAC/VDC
Interrupting rating at rated voltage	50 A	150 A	50 A	50 A	50 A	50 A	50 A	50–100 A
Amperage rating	2–6 A	10–20 A	1–8 A	0.25–6 A	0.250–8 A	0.75–2 A	0.25–8 A	0.75–5 A
Operating temperature	-55 °C to 150 °C	-55 °C to 150 °C	-55 °C to 150 °C	-55 °C to 150 °C	-55 °C to 150 °C	-55 °C to 125 °C	-55 °C to 150 °C	-55 °C to 125 °C

Key highlights

- AEC-Q200 Qualified
- Wide range of fuse selections (24–250 VAC/VDC) and amperage ratings (0.25–20 A)
- Compact body size (0603, 1206, and 2410)

This document is provided by Littelfuse, Inc. ("Littelfuse") for informational and guideline purposes only. Littelfuse assumes no liability for errors or omissions in this document or for any of the information contained herein. Information is provided on an "as is" and "with all faults" basis for evaluation purposes only. Applications described are for illustrative purposes only, and Littelfuse makes no representation that such applications will be suitable for the customer's specific use without further testing or modification. Littelfuse expressly disclaims all warranties, whether express, implied, or statutory, including but not limited to the implied warranties of merchantability and fitness for a particular purpose and non-infringement. It is the customer's sole responsibility to determine suitability for a particular system or use based on their own performance criteria, conditions, specific application, compatibility with other components, and environmental conditions. Customers must independently provide an appropriate design and operating safeguards to minimize any risks associated with their applications and products. Read complete Disclaimer Notice at: www.littelfuse.com/disclaimer-electronics.



Expertise Applied | Answers Delivered

Littelfuse.com