

526 Series

Lead-free > 10x32mm Fuse



Description

The 526 series fuses are specifically designed and tested to the circuit protection needs of compact auto-electronics applications, which is 500 Vdc/Vac rated with remarkable interrupting rating.

Features & Benefits

- RoHS compliant and Lead-free
- High Interrupt Rating
- Recognized to UL/CSA/NMX 248-1 and UL/CSA/NMX 248-14
- Small size
- High current
- High voltage
- High breaking capacity
- Available in through-hole or bolt down

Additional Information



Resources



Accessories



Samples

Applications

- On-Board Charger (OBC)
- Power Distribution Unit (PDU)

Agency Approvals

Agency	Agency File Number	Ampere Range
	E10480	30 A - 60 A

Electrical Characteristics

% of Ampere Rating	Ampere Rating	Opening Time at 25°C
100%	30 A to 60 A	4 hours, Min.
135%	30 A to 40 A	60 minutes, Max.
200%	30 A to 60 A	120 seconds, Max.

Electrical Specifications

Ampere Rating (A)	Amp Code	Max Voltage Rating (V)	Interrupting Rating (AC/DC)	Nominal Cold Resistance (Ohm) ¹	Nominal Melting I ² t (A ² sec) ²	Agency Approvals
30	030.	500VDC 500VAC	10KA@500VDC 10KA@500VAC	0.0028	1070	x
40	040.			0.0018	2340	x
50	050.			0.0014	3850	x
60	060.	500VDC 300VAC	10KA@500VDC 10KA@300VAC	0.0011	6290	x

Notes:

1. Resistance is measured at 10% of rated current, 25 °C.
2. Nominal Melting I²t is measured at 10 the Ampere Rating (I_a)

526 Series

Lead-free > 10x32mm Fuse

Temperature Re-rating Curve

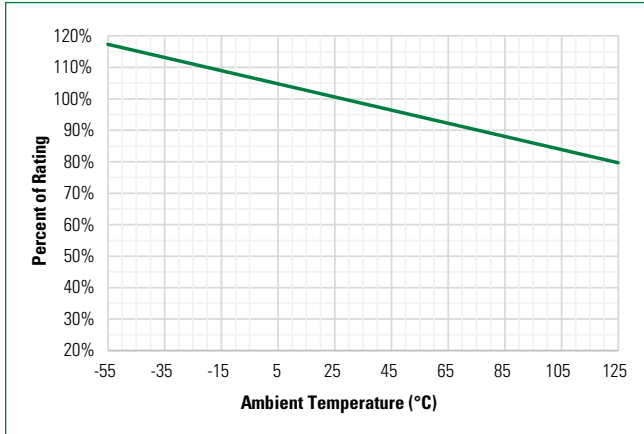

Note:
Rerating depicted in this curve is in addition to the standard derating of 25% for continuous operation.

Average Time Current Curves

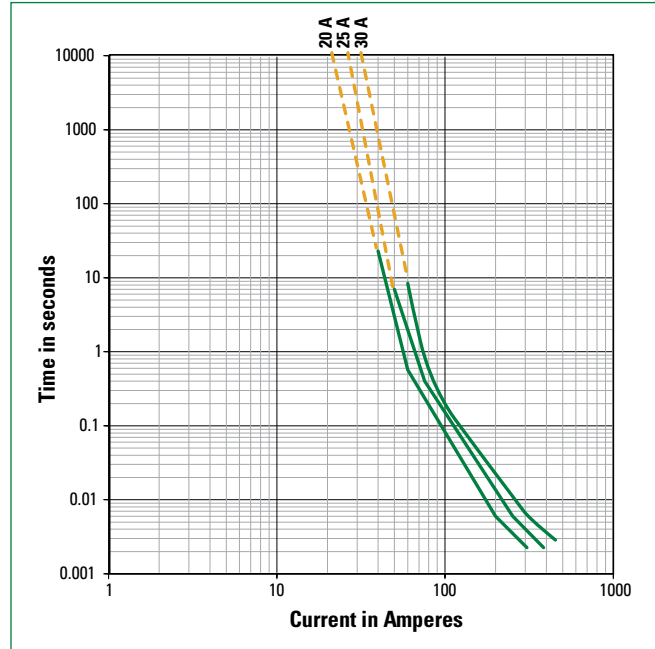

Note:
The 50 A and 60 A ratings, it may not break current consistently when overload current is less than 200%In (represented by dotted portion of this time-current curve), as maybe arc current continuously pass-through fuse under this condition. It is not recommended to use in conditions requiring overloads below 200%In

Product Characteristics

Materials	Body: Glass fiber Cap: Ni plated copper alloy Terminal: Ni/Sn plated copper alloy
Mechanical Shock	MIL-STD-202, Method 213, Test Condition I (100 G's peak for 6 milliseconds)
Solderability	Reference MIL-STD-202 method 208
Product Marking	Cap 1: Brand logo, current and voltage ratings Cap 2: Agency approval marks
Resistance to Solder Heat	MIL-Std 202 Method 210 Test Condition B (10 sec at 260 °C)
Operating Temperature	-55 °C to +125 °C
Thermal Shock	MIL-STD-202G, Method 107G, Test condition B
Vibration	MIL-STD-202G, Method 201A
Moisture Resistance	MIL-STD-202G, Method 103B, Test condition A
Salt Spray	MIL-STD-202G, Method 101E, Test condition B

Soldering Parameters–Wave Soldering

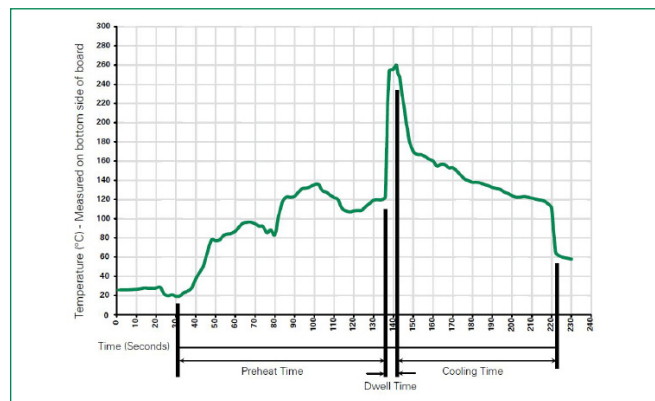

Wave Parameter	Lead-Free Recommendation
Preheat: (Depends on Flex Activation Temperature)	(Typical Industry Recommendation)
Temperature Minimum	100 °C
Temperature Maximum	150 °C
Preheat Time	60–180 seconds
Solder Pot Temperature	260 °C Maximum
Solder Dwell Time	2–5 seconds

Recommended Hand-Solder Parameters:

Solder Iron Temperature: 350 °C +/- 5 °C
Heating Time: 5 seconds max.

Note: These devices are not recommended for IR or Convection Reflow process.

526 Series

Lead-free > 10x32mm Fuse

Dimensions (mm)

- Through-hole terminal

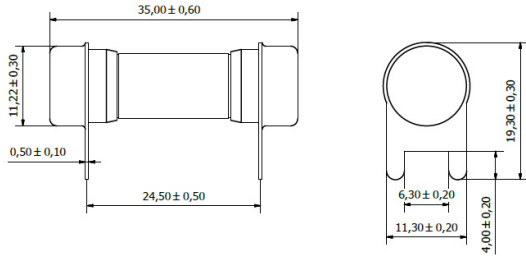

- Bolt down terminal

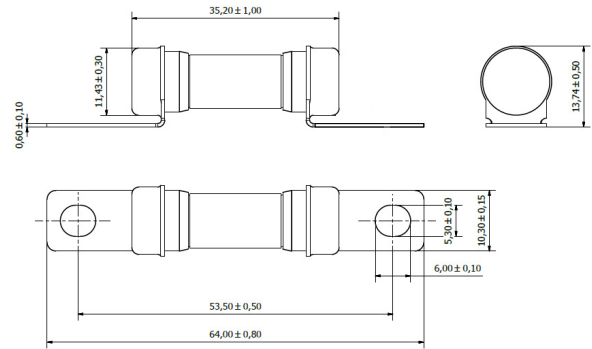

Recommended PCB layout

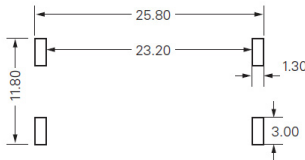

Part Numbering System

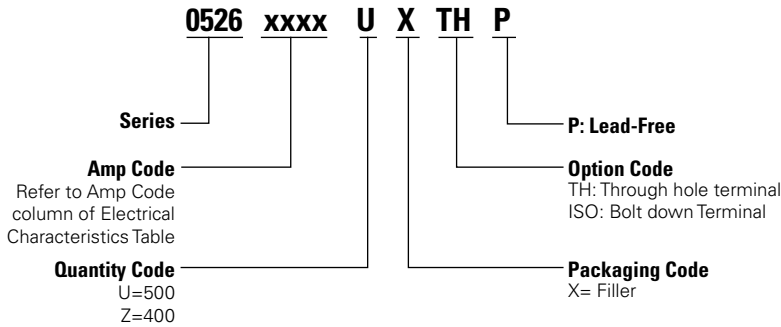

Packaging

Packaging Option	Packaging Specification	Quantity	Quantity & Packaging Code	Reel Size
526 Through hole terminal				
Tray	NA	500	NA	NA
526 Bolt down terminal				
Tray	NA	400	NA	NA

Disclaimer Notice - Information furnished is believed to be accurate and reliable. However, users should independently evaluate the suitability of and test each product selected for their own applications. Littelfuse products are not designed for, and may not be used in, all applications. Read complete Disclaimer Notice at <http://www.littelfuse.com/disclaimer-electronics>.