

# Metal Composite Power Inductors MPXV

## Automotive Grade



### Overview

The KEMET MPXV metal composite inductors are ideal for use in DC to DC switching power supplies for automotive applications. The metal composite core has high saturation capabilities maintaining functionality with high current transients and is characterized by temperature stable inductance.

### Applications

Automotive ECU applications such as:

- LED headlights
- Meter cluster panels
- Head-up displays (HUD)
- Electric water pumps (EWP)
- Electric oil pumps (EOP)
- Electric power steering (EPS)

### Benefits

- Metal composite powder
- Shielded construction, SMD configuration
- Inductance range from 0.10 to 100.00  $\mu\text{H}$
- Operating temperature up to +155°C
- Low acoustic noise
- Low magnetic flux leakage
- AEC-Q200 qualified



### Part Number System

MPX	1	D0520		L	1R5
Series	Version	Size Code		Inductor	Inductance Code $\mu\text{H}$
MPXV	1	D0520 = 5x5x2.0 mm D0530 = 5x5x3.0 mm D0618 = 6x6x1.8 mm D0624 = 6x6x2.4 mm D0630 = 6x6x3.0 mm D0650 = 6x6x5.0 mm D0830 = 8x8x3.0 mm D0840 = 8x8x4.0 mm	D1040 = 10x10x4.0 mm D1054 = 10x10x5.4 mm D1235 = 12x12x3.5 mm D1250 = 12x12x5.0 mm D1264 = 12x12x6.4 mm D1740 = 17x17x4.0 mm D1770 = 17x17x7.0 mm D2213 = 22x22x13.0 mm		<p>The first two digits represent the inductance value. The third digit indicates the number of zeros to be added. R = decimal point</p> <p>Examples:            100 = 10.00 <math>\mu\text{H}</math>            R68 = 0.68 <math>\mu\text{H}</math>            1R5 = 1.50 <math>\mu\text{H}</math>            101 = 100.00 <math>\mu\text{H}</math></p>

## Performance Characteristics

Item	Performance Characteristics
Operating Temperature	-55°C to +155°C (including self-temperature rise)
Rated Inductance Range	0.10 – 100.00 µH at 100 kHz, 1 mA
Inductance Tolerance	±20%
Rated DC Resistance Range	0.48 – 341.2 mΩ maximum
Rated Current Range	2 – 90 A

### Table 1 – Ratings & Part Number Reference

Part Number	Inductance (µH) at 100 kHz, 1 mA	Inductance Tolerance	DC Resistance (mΩ) Typical	DC Resistance (mΩ) Maximum	Rated Current (A)			Self-Resonance Frequency (MHz)
					I <sub>rms</sub> <sup>1</sup> (Reference)	I <sub>sat</sub> <sup>2</sup> (Reference)	I <sub>sat</sub> <sup>3</sup> (Reference)	
MPXV1D0520LR15	0.15	±20%	3.40	3.90	16.9	15.5	22.0	190.0
MPXV1D0520LR22	0.22	±20%	4.30	5.00	15.0	14.5	19.0	150.0
MPXV1D0520LR33	0.33	±20%	5.30	6.20	13.4	11.0	16.0	110.0
MPXV1D0520LR47	0.47	±20%	6.70	7.80	12.0	9.0	14.0	87.0
MPXV1D0520LR68	0.68	±20%	10.60	12.20	9.5	7.5	11.0	74.0
MPXV1D0520LR1R0	1.00	±20%	16.40	18.90	7.6	7.0	9.0	62.0
MPXV1D0520LR1R5	1.50	±20%	30.90	35.60	5.6	4.5	7.0	44.0
MPXV1D0520LR2R2	2.20	±20%	35.10	40.40	5.2	4.5	6.5	39.0
MPXV1D0520LR3R3	3.30	±20%	55.80	64.20	4.1	3.5	5.5	34.0
MPXV1D0520LR4R7	4.70	±20%	84.00	96.60	3.4	3.5	4.5	26.0
MPXV1D0520LR6R8	6.80	±20%	113.40	130.50	2.9	2.5	4.0	22.0
MPXV1D0520LR100	10.00	±20%	193.70	222.80	2.2	2.5	3.5	20.0
MPXV1D0530LR15	0.15	±20%	2.40	2.80	22.0	15.0	21.0	180.0
MPXV1D0530LR22	0.22	±20%	3.40	3.90	18.4	11.0	16.0	140.0
MPXV1D0530LR33	0.33	±20%	4.50	5.20	16.0	10.5	15.0	110.0
MPXV1D0530LR47	0.47	±20%	6.00	6.90	13.8	9.0	13.0	91.0
MPXV1D0530LR68	0.68	±20%	7.10	8.20	12.6	8.0	12.0	70.0
MPXV1D0530LR1R0	1.00	±20%	10.00	11.50	10.7	7.5	10.5	52.0
MPXV1D0530LR1R5	1.50	±20%	15.30	17.70	8.6	5.5	8.0	45.0
MPXV1D0530LR2R2	2.20	±20%	21.40	24.60	7.3	4.5	6.5	35.0
MPXV1D0530LR3R3	3.30	±20%	37.20	42.80	5.5	4.0	5.5	29.0
MPXV1D0530LR4R7	4.70	±20%	54.10	62.20	4.6	3.0	4.5	26.0
MPXV1D0530LR6R8	6.80	±20%	93.70	107.80	3.5	2.5	4.0	23.0
MPXV1D0530LR100	10.00	±20%	121.80	140.10	3.1	2.5	3.5	18.0
MPXV1D0530LR150	15.00	±20%	186.50	214.60	2.5	2.0	3.0	15.0
MPXV1D0530LR220	22.00	±20%	296.60	341.20	2.0	1.8	2.5	12.0
MPXV1D0618LR10	0.10	±20%	2.40	2.80	18.9	22.5	40.0	230.0
MPXV1D0618LR15	0.15	±20%	3.20	3.80	16.2	20.0	30.0	170.0
MPXV1D0618LR22	0.22	±20%	4.60	5.30	13.7	16.0	26.0	140.0
Part Number	Inductance (µH) at 100 kHz, 1 mA	Inductance Tolerance	DC Resistance (mΩ) Typical	DC Resistance (mΩ) Maximum	I <sub>rms</sub> <sup>1</sup>	I <sub>sat</sub> <sup>2</sup>	I <sub>sat</sub> <sup>3</sup>	Self-Resonance Frequency (MHz)
					Rated Current (A)			

<sup>1</sup> T = 40 K rise at rated current

<sup>2</sup> Inductance drop 20% at rated current

<sup>3</sup> Inductance drop 30% at rated current

All electrical characteristics data is referenced to 25°C.

Table 1 – Ratings &amp; Part Number Reference cont.

Part Number	Inductance (µH) at 100 kHz, 1 mA	Inductance Tolerance	DC Resistance (mΩ) Typical	DC Resistance (mΩ) Maximum	Rated Current (A)			Self-Resonance Frequency (MHz)
					I <sub>rms</sub> <sup>1</sup> (Reference)	I <sub>sat</sub> <sup>2</sup> (Reference)	I <sub>sat</sub> <sup>3</sup> (Reference)	
MPXV1D0618LR33	0.33	±20%	5.30	6.10	12.7	15.0	20.0	96.0
MPXV1D0618LR47	0.47	±20%	7.40	8.50	10.7	11.0	17.0	95.0
MPXV1D0618LR68	0.68	±20%	11.00	12.70	8.8	9.0	13.0	95.0
MPXV1D0618LR1R0	1.00	±20%	16.70	19.30	7.1	8.0	11.0	55.0
MPXV1D0618LR5	1.50	±20%	22.40	25.80	6.2	6.5	10.5	40.0
MPXV1D0618LR2R2	2.20	±20%	29.40	33.80	5.4	6.0	9.0	39.0
MPXV1D0618LR3R3	3.30	±20%	53.40	61.50	4.0	4.5	6.5	30.0
MPXV1D0618LR4R7	4.70	±20%	72.50	83.40	3.4	4.0	6.0	26.0
MPXV1D0624LR10	0.10	±20%	1.50	1.80	26.6	25.0	42.0	210.0
MPXV1D0624LR15	0.15	±20%	2.00	2.30	23.2	20.5	37.0	130.0
MPXV1D0624LR22	0.22	±20%	2.80	3.30	19.4	19.5	29.0	120.0
MPXV1D0624LR33	0.33	±20%	3.60	4.20	17.2	17.5	22.5	91.0
MPXV1D0624LR47	0.47	±20%	4.50	5.20	15.4	14.5	20.0	71.0
MPXV1D0624LR68	0.68	±20%	6.70	7.80	12.6	11.5	16.0	57.0
MPXV1D0624LR1R0	1.00	±20%	9.10	10.50	10.8	9.0	13.0	46.0
MPXV1D0624LR5	1.50	±20%	16.10	18.50	8.1	7.0	10.0	43.0
MPXV1D0624LR2R2	2.20	±20%	26.60	30.70	6.3	6.0	9.0	34.0
MPXV1D0624LR3R3	3.30	±20%	29.40	33.80	6.0	5.0	8.0	27.0
MPXV1D0624LR4R7	4.70	±20%	44.00	50.60	4.9	5.5	6.5	22.0
MPXV1D0624LR6R8	6.80	±20%	58.60	67.40	4.3	4.5	5.5	18.0
MPXV1D0624LR100	10.00	±20%	98.40	113.20	3.3	3.5	4.5	16.0
MPXV1D0630LR10	0.10	±20%	1.30	1.50	31.1	35.0	50.0	200.0
MPXV1D0630LR15	0.15	±20%	1.60	1.90	27.6	24.0	40.0	130.0
MPXV1D0630LR22	0.22	±20%	2.20	2.60	23.3	22.0	33.0	110.0
MPXV1D0630LR33	0.33	±20%	2.70	3.20	21.1	17.0	25.0	84.0
MPXV1D0630LR47	0.47	±20%	3.50	4.00	18.7	15.0	21.0	70.0
MPXV1D0630LR68	0.68	±20%	5.30	6.20	15.1	11.5	17.0	55.0
MPXV1D0630LR1R0	1.00	±20%	7.10	8.20	13.1	9.0	13.0	43.0
MPXV1D0630LR5	1.50	±20%	11.00	12.70	10.5	7.0	11.0	38.0
MPXV1D0630LR2R2	2.20	±20%	15.90	18.30	8.7	6.5	9.0	30.0
MPXV1D0630LR3R3	3.30	±20%	26.30	30.30	6.8	5.0	7.0	26.0
MPXV1D0630LR4R7	4.70	±20%	31.80	36.70	6.2	4.5	6.5	21.0
MPXV1D0630LR6R8	6.80	±20%	44.20	50.90	5.2	4.0	5.5	16.0
MPXV1D0630LR100	10.00	±20%	67.80	78.00	4.2	3.5	4.5	15.0
MPXV1D0630LR150	15.00	±20%	113.20	130.20	3.3	3.0	4.0	13.0
MPXV1D0630LR220	22.00	±20%	162.00	186.30	2.7	2.5	3.5	9.6
MPXV1D0650LR68	0.68	±20%	3.60	4.10	18.8	12.0	17.0	54.0
Part Number	Inductance (µH) at 100 kHz, 1 mA	Inductance Tolerance	DC Resistance (mΩ) Typical	DC Resistance (mΩ) Maximum	I <sub>rms</sub> <sup>1</sup>	I <sub>sat</sub> <sup>2</sup>	I <sub>sat</sub> <sup>3</sup>	Self-Resonance Frequency (MHz)
					Rated Current (A)			

<sup>1</sup> T = 40 K rise at rated current<sup>2</sup> Inductance drop 20% at rated current<sup>3</sup> Inductance drop 30% at rated current

All electrical characteristics data is referenced to 25°C.

Table 1 – Ratings &amp; Part Number Reference cont.

Part Number	Inductance (µH) at 100 kHz, 1 mA	Inductance Tolerance	DC Resistance (mΩ) Typical	DC Resistance (mΩ) Maximum	Rated Current (A)			Self-Resonance Frequency (MHz)
					I <sub>rms</sub> <sup>1</sup> (Reference)	I <sub>sat</sub> <sup>2</sup> (Reference)	I <sub>sat</sub> <sup>3</sup> (Reference)	
MPXV1D0650L1R0	1.00	±20%	5.10	6.00	15.6	9.0	13.0	42.0
MPXV1D0650L1R5	1.50	±20%	7.20	8.30	13.2	7.5	12.0	35.0
MPXV1D0650L2R2	2.20	±20%	10.00	11.60	11.2	7.0	10.0	30.0
MPXV1D0650L3R3	3.30	±20%	16.40	18.90	8.7	5.0	8.0	26.0
MPXV1D0650L4R7	4.70	±20%	27.80	32.00	6.7	4.5	6.5	19.0
MPXV1D0650L6R8	6.80	±20%	38.40	44.20	5.7	4.0	5.5	17.0
MPXV1D0650L100	10.00	±20%	53.40	61.40	4.8	3.5	4.5	13.0
MPXV1D0830LR22	0.22	±20%	1.60	1.90	30.7	27.0	43.0	140.0
MPXV1D0830LR33	0.33	±20%	2.30	2.70	25.8	22.5	35.0	83.0
MPXV1D0830LR47	0.47	±20%	2.70	3.10	24.0	20.5	30.0	80.0
MPXV1D0830LR68	0.68	±20%	3.80	4.40	20.1	20.0	28.0	55.0
MPXV1D0830L1R0	1.00	±20%	5.00	5.70	17.6	16.0	23.0	46.0
MPXV1D0830L1R5	1.50	±20%	7.90	9.10	14.0	13.0	18.0	37.0
MPXV1D0830L2R2	2.20	±20%	11.80	13.60	11.4	11.0	14.0	30.0
MPXV1D0830L3R3	3.30	±20%	19.40	22.30	8.9	9.0	12.5	24.0
MPXV1D0830L4R7	4.70	±20%	25.80	29.70	7.7	7.5	10.5	18.0
MPXV1D0830L6R8	6.80	±20%	32.90	37.90	6.8	7.5	10.0	16.0
MPXV1D0830L100	10.00	±20%	53.60	61.70	5.4	5.5	8.0	12.0
MPXV1D0830L150	15.00	±20%	82.30	94.60	4.3	4.5	6.5	11.0
MPXV1D0830L220	22.00	±20%	116.90	134.50	3.6	3.5	5.0	8.1
MPXV1D0830L330	33.00	±20%	199.60	229.50	2.8	3.0	4.0	6.9
MPXV1D0840LR22	0.22	±20%	1.20	1.50	35.4	35.0	53.0	100.0
MPXV1D0840LR33	0.33	±20%	2.00	2.40	27.7	30.0	45.0	77.0
MPXV1D0840LR47	0.47	±20%	2.30	2.70	25.8	26.0	38.0	59.0
MPXV1D0840LR68	0.68	±20%	3.10	3.60	22.4	20.5	30.0	46.0
MPXV1D0840L1R0	1.00	±20%	3.60	4.20	20.8	19.5	28.0	40.0
MPXV1D0840L1R5	1.50	±20%	5.80	6.80	16.2	14.0	19.0	29.0
MPXV1D0840L2R2	2.20	±20%	7.50	8.70	14.3	13.0	17.0	27.0
MPXV1D0840L3R3	3.30	±20%	12.10	14.00	11.3	11.0	15.0	22.0
MPXV1D0840L4R7	4.70	±20%	20.40	23.50	8.7	7.5	11.0	17.0
MPXV1D0840L6R8	6.80	±20%	29.00	33.40	7.3	6.5	9.0	13.0
MPXV1D0840L100	10.00	±20%	43.10	49.60	6.0	5.5	7.5	12.0
MPXV1D0840L150	15.00	±20%	56.50	65.00	5.2	4.5	6.5	9.0
MPXV1D0840L220	22.00	±20%	85.40	98.30	4.2	4.0	5.5	7.7
MPXV1D0840L330	33.00	±20%	134.10	154.20	3.4	3.5	4.5	6.2
MPXV1D0840L470	47.00	±20%	197.10	226.70	2.8	2.5	3.5	5.7
MPXV1D1040LR22	0.22	±20%	1.40	1.60	32.7	40.0	60.0	108.0
Part Number	Inductance (µH) at 100 kHz, 1 mA	Inductance Tolerance	DC Resistance (mΩ) Typical	DC Resistance (mΩ) Maximum	I <sub>rms</sub> <sup>1</sup>	I <sub>sat</sub> <sup>2</sup>	I <sub>sat</sub> <sup>3</sup>	Self-Resonance Frequency (MHz)
					Rated Current (A)			

<sup>1</sup> T = 40 K rise at rated current<sup>2</sup> Inductance drop 20% at rated current<sup>3</sup> Inductance drop 30% at rated current

All electrical characteristics data is referenced to 25°C.

Table 1 – Ratings &amp; Part Number Reference cont.

Part Number	Inductance (µH) at 100 kHz, 1 mA	Inductance Tolerance	DC Resistance (mΩ) Typical	DC Resistance (mΩ) Maximum	Rated Current (A)			Self-Resonance Frequency (MHz)
					I <sub>rms</sub> <sup>1</sup> (Reference)	I <sub>sat</sub> <sup>2</sup> (Reference)	I <sub>sat</sub> <sup>3</sup> (Reference)	
MPXV1D1040LR33	0.33	±20%	1.60	1.90	29.7	31.0	47.0	75.0
MPXV1D1040LR47	0.47	±20%	2.10	2.40	26.4	29.0	42.0	65.0
MPXV1D1040LR68	0.68	±20%	2.70	3.20	23.1	23.0	34.5	47.0
MPXV1D1040LR1R0	1.00	±20%	3.30	3.80	21.1	19.5	29.0	35.0
MPXV1D1040LR1R5	1.50	±20%	4.60	5.40	17.7	18.0	26.0	30.0
MPXV1D1040LR2R2	2.20	±20%	6.80	7.90	14.6	13.0	18.5	23.0
MPXV1D1040LR3R3	3.30	±20%	11.10	12.80	11.4	11.0	15.0	18.0
MPXV1D1040LR4R7	4.70	±20%	13.80	15.90	10.3	10.0	14.0	17.0
MPXV1D1040LR6R8	6.80	±20%	20.90	24.10	8.3	8.0	11.5	14.0
MPXV1D1040LR100	10.00	±20%	29.60	34.10	7.0	7.5	10.5	11.0
MPXV1D1040LR150	15.00	±20%	44.50	51.20	5.7	5.5	8.5	8.0
MPXV1D1040LR220	22.00	±20%	66.20	76.10	4.7	5.0	7.0	7.0
MPXV1D1040LR330	33.00	±20%	104.10	119.70	3.7	3.5	5.0	5.0
MPXV1D1040LR470	47.00	±20%	158.80	182.60	3.0	3.0	4.0	4.5
MPXV1D1054LR33	0.33	±20%	1.10	1.27	37.3	45.0	60.0	56.0
MPXV1D1054LR47	0.47	±20%	1.60	1.84	30.9	39.0	51.0	46.0
MPXV1D1054LR68	0.68	±20%	2.00	2.30	27.6	27.0	37.5	38.0
MPXV1D1054LR1R0	1.00	±20%	2.90	3.34	22.9	20.0	27.0	31.0
MPXV1D1054LR2R2	2.20	±20%	4.70	5.41	18.0	12.0	16.5	21.0
MPXV1D1054LR3R3	3.30	±20%	7.30	8.40	14.4	11.0	15.0	17.0
MPXV1D1054LR4R7	4.70	±20%	11.90	13.69	11.3	10.0	14.0	14.0
MPXV1D1054LR100	10.00	±20%	24.00	27.60	7.9	8.5	12.0	9.5
MPXV1D1054LR150	15.00	±20%	34.00	39.10	6.7	8.0	11.0	7.5
MPXV1D1054LR220	22.00	±20%	47.00	54.05	5.7	5.0	7.0	6.5
MPXV1D1054LR330	33.00	±20%	70.00	80.50	4.6	4.4	6.0	5.0
MPXV1D1054LR470	47.00	±20%	112.00	128.80	3.7	3.4	4.6	4.0
MPXV1D1235LR15	0.15	±20%	1.10	1.30	39.9	54.0	85.0	128.0
MPXV1D1235LR22	0.22	±20%	1.30	1.60	35.2	50.0	75.0	100.0
MPXV1D1235LR33	0.33	±20%	1.50	1.80	33.4	40.0	55.0	63.0
MPXV1D1235LR47	0.47	±20%	2.00	2.30	28.9	31.0	45.0	58.0
MPXV1D1235LR68	0.68	±20%	2.50	2.90	25.9	28.0	40.0	46.0
MPXV1D1235LR1R0	1.00	±20%	3.60	4.20	21.5	22.0	32.5	33.0
MPXV1D1235LR1R5	1.50	±20%	5.20	6.00	17.9	19.0	28.0	29.0
MPXV1D1235LR2R2	2.20	±20%	7.30	8.40	15.2	15.5	23.0	21.0
MPXV1D1235LR3R3	3.30	±20%	10.60	12.20	12.5	12.0	18.0	18.0
MPXV1D1235LR4R7	4.70	±20%	14.20	16.40	10.9	11.5	17.5	14.0
MPXV1D1235LR6R8	6.80	±20%	18.80	21.70	9.4	9.5	14.0	12.0
Part Number	Inductance (µH) at 100 kHz, 1 mA	Inductance Tolerance	DC Resistance (mΩ) Typical	DC Resistance (mΩ) Maximum	Rated Current (A)			Self-Resonance Frequency (MHz)
					I <sub>rms</sub> <sup>1</sup>	I <sub>sat</sub> <sup>2</sup>	I <sub>sat</sub> <sup>3</sup>	

<sup>1</sup> T = 40 K rise at rated current<sup>2</sup> Inductance drop 20% at rated current<sup>3</sup> Inductance drop 30% at rated current

All electrical characteristics data is referenced to 25°C.

Table 1 – Ratings &amp; Part Number Reference cont.

Part Number	Inductance (µH) at 100 kHz, 1 mA	Inductance Tolerance	DC Resistance (mΩ) Typical	DC Resistance (mΩ) Maximum	Rated Current (A)			Self-Resonance Frequency (MHz)
					I <sub>rms</sub> <sup>1</sup> (Reference)	I <sub>sat</sub> <sup>2</sup> (Reference)	I <sub>sat</sub> <sup>3</sup> (Reference)	
MPXV1D1235L100	10.00	±20%	30.40	35.00	7.4	8.5	12.0	9.5
MPXV1D1250LR22	0.22	±20%	1.00	1.20	42.7	55.0	85.0	95.0
MPXV1D1250LR33	0.33	±20%	1.10	1.30	41.6	45.0	65.0	68.0
MPXV1D1250LR47	0.47	±20%	1.50	1.80	34.8	37.0	55.0	54.0
MPXV1D1250LR68	0.68	±20%	1.70	2.00	32.7	30.0	45.0	45.0
MPXV1D1250L1R0	1.00	±20%	2.20	2.60	28.8	30.5	43.0	34.0
MPXV1D1250L1R5	1.50	±20%	3.10	3.60	24.2	22.0	32.0	25.0
MPXV1D1250L2R2	2.20	±20%	4.10	4.80	21.0	20.0	28.5	21.0
MPXV1D1250L3R3	3.30	±20%	6.40	7.40	16.8	15.0	22.0	17.0
MPXV1D1250L4R7	4.70	±20%	8.80	10.10	14.4	12.0	17.5	13.0
MPXV1D1250L6R8	6.80	±20%	13.40	15.50	11.6	10.0	14.0	10.0
MPXV1D1250L100	10.00	±20%	17.90	20.60	10.1	9.0	13.5	8.5
MPXV1D1250L150	15.00	±20%	26.80	30.80	8.2	7.5	11.0	7.0
MPXV1D1250L220	22.00	±20%	40.10	46.20	6.7	6.5	9.0	6.5
MPXV1D1250L330	33.00	±20%	62.60	72.00	5.4	5.0	7.5	5.0
MPXV1D1250L470	47.00	±20%	91.60	105.40	4.5	4.0	5.5	4.0
MPXV1D1250L680	68.00	±20%	141.70	163.00	3.6	3.0	4.5	3.0
MPXV1D1264LR22	0.22	±20%	0.90	1.10	53.0	68.0	100.0	90.0
MPXV1D1264LR33	0.33	±20%	1.00	1.20	45.6	48.0	70.0	61.0
MPXV1D1264LR47	0.47	±20%	1.40	1.70	38.2	40.0	58.0	53.0
MPXV1D1264LR68	0.68	±20%	1.70	1.90	35.4	34.0	50.0	45.0
MPXV1D1264L1R0	1.00	±20%	2.00	2.30	32.2	30.0	45.0	30.0
MPXV1D1264L1R5	1.50	±20%	2.50	2.90	28.8	25.0	35.5	24.0
MPXV1D1264L2R2	2.20	±20%	3.20	3.70	25.4	23.0	32.0	20.0
MPXV1D1264L3R3	3.30	±20%	5.30	6.20	19.7	16.5	22.5	16.0
MPXV1D1264L4R7	4.70	±20%	7.10	8.20	17.1	14.0	19.5	13.0
MPXV1D1264L6R8	6.80	±20%	10.60	12.30	14.0	11.5	16.0	10.0
MPXV1D1264L100	10.00	±20%	14.00	16.10	12.2	10.0	14.0	8.5
MPXV1D1264L150	15.00	±20%	21.60	24.90	9.8	8.0	11.5	6.5
MPXV1D1264L220	22.00	±20%	30.50	35.10	8.2	7.0	9.5	5.5
MPXV1D1740LR47	0.47	±20%	1.50	1.80	34.0	52.0	75.0	46.0
MPXV1D1740LR68	0.68	±20%	1.70	2.00	32.0	37.0	55.0	38.0
MPXV1D1740L1R0	1.00	±20%	2.00	2.30	30.0	28.0	43.0	30.0
MPXV1D1740L1R5	1.50	±20%	3.30	3.80	23.5	19.5	28.0	24.0
MPXV1D1740L2R2	2.20	±20%	4.30	5.00	20.5	19.5	28.0	17.0
MPXV1D1740L3R3	3.30	±20%	7.00	8.10	16.5	18.0	27.5	14.0
MPXV1D1740L4R7	4.70	±20%	9.00	10.40	14.5	13.0	18.5	12.0
Part Number	Inductance (µH) at 100 kHz, 1 mA	Inductance Tolerance	DC Resistance (mΩ) Typical	DC Resistance (mΩ) Maximum	I <sub>rms</sub> <sup>1</sup>	I <sub>sat</sub> <sup>2</sup>	I <sub>sat</sub> <sup>3</sup>	Self-Resonance Frequency (MHz)
					Rated Current (A)			

<sup>1</sup> T = 40 K rise at rated current<sup>2</sup> Inductance drop 20% at rated current<sup>3</sup> Inductance drop 30% at rated current

All electrical characteristics data is referenced to 25°C.

Table 1 – Ratings &amp; Part Number Reference cont.

Part Number	Inductance (µH) at 100 kHz, 1 mA	Inductance Tolerance	DC Resistance (mΩ) Typical	DC Resistance (mΩ) Maximum	Rated Current (A)			Self-Resonance Frequency (MHz)
					I <sub>rms</sub> <sup>1</sup> (Reference)	I <sub>sat</sub> <sup>2</sup> (Reference)	I <sub>sat</sub> <sup>3</sup> (Reference)	
MPXV1D1740L6R8	6.80	±20%	13.80	15.90	11.5	12.0	17.0	9.0
MPXV1D1740L100	10.00	±20%	18.80	21.70	9.5	10.0	14.5	6.8
MPXV1D1740L150	15.00	±20%	30.60	35.20	7.5	9.0	13.0	6.0
MPXV1D1740L220	22.00	±20%	40.30	46.40	6.5	7.0	10.0	5.0
MPXV1D1740L330	33.00	±20%	71.50	82.30	5.0	5.5	8.0	4.0
MPXV1D1740L470	47.00	±20%	109.30	125.70	4.0	4.4	6.5	2.5
MPXV1D1770LR47	0.47	±20%	0.87	1.00	52.5	72.0	108.0	45.0
MPXV1D1770LR68	0.68	±20%	0.91	1.05	50.0	46.0	68.0	37.0
MPXV1D1770L1R0	1.00	±20%	1.50	1.80	38.0	42.0	62.0	27.0
MPXV1D1770L1R5	1.50	±20%	1.50	1.80	38.0	31.0	45.0	18.0
MPXV1D1770L2R2	2.20	±20%	2.20	2.60	31.0	25.0	34.0	15.0
MPXV1D1770L3R3	3.30	±20%	2.90	3.40	28.0	24.0	30.5	13.0
MPXV1D1770L4R7	4.70	±20%	4.10	4.80	23.5	24.0	33.5	10.0
MPXV1D1770L6R8	6.80	±20%	5.90	6.80	19.5	18.0	26.0	8.0
MPXV1D1770L100	10.00	±20%	10.60	12.20	14.5	11.5	16.5	7.0
MPXV1D1770L150	15.00	±20%	15.40	17.80	12.0	10.5	14.0	5.5
MPXV1D1770L220	22.00	±20%	19.90	22.90	10.5	8.5	12.0	4.5
MPXV1D1770L330	33.00	±20%	41.10	47.30	7.5	8.5	12.0	3.5
MPXV1D1770L470	47.00	±20%	54.60	62.80	6.5	7.5	10.5	2.8
MPXV1D1770L680	68.00	±20%	69.10	79.50	5.5	6.0	8.5	2.3
MPXV1D1770L101	100.00	±20%	95.90	110.30	4.5	5.6	7.5	1.8
MPXV1D2213LR47	0.47	±20%	0.42	0.48	90.0	96.0	140.0	45.0
MPXV1D2213LR68	0.68	±20%	0.72	0.83	78.0	80.0	115.0	34.0
MPXV1D2213L1R0	1.00	±20%	0.80	1.00	74.0	58.0	84.0	22.0
MPXV1D2213L1R5	1.50	±20%	0.96	1.20	68.0	42.0	60.0	17.0
MPXV1D2213L2R2	2.20	±20%	1.20	1.40	59.0	38.0	56.0	14.0
MPXV1D2213L3R3	3.30	±20%	1.50	1.80	54.0	34.0	48.0	11.0
MPXV1D2213L4R7	4.70	±20%	1.90	2.20	48.0	28.0	40.0	9.0
MPXV1D2213L6R8	6.80	±20%	2.80	3.30	39.0	30.0	42.0	6.5
MPXV1D2213L100	10.00	±20%	3.80	4.40	34.0	26.0	36.0	5.2
MPXV1D2213L150	15.00	±20%	5.90	6.80	27.5	22.0	30.0	4.0
MPXV1D2213L220	22.00	±20%	11.40	13.20	19.5	15.0	20.5	3.7
MPXV1D2213L330	33.00	±20%	13.90	16.00	17.5	15.0	20.5	2.9
MPXV1D2213L470	47.00	±20%	17.80	20.50	15.5	13.5	19.0	2.5
MPXV1D2213L680	68.00	±20%	26.70	30.80	12.5	10.0	14.0	2.1
MPXV1D2213L101	100.00	±20%	41.20	47.40	10.0	8.0	10.5	1.6
Part Number	Inductance (µH) at 100 kHz, 1 mA	Inductance Tolerance	DC Resistance (mΩ) Typical	DC Resistance (mΩ) Maximum	Rated Current (A)			Self-Resonance Frequency (MHz)
					I <sub>rms</sub> <sup>1</sup>	I <sub>sat</sub> <sup>2</sup>	I <sub>sat</sub> <sup>3</sup>	

<sup>1</sup> T = 40 K rise at rated current<sup>2</sup> Inductance drop 20% at rated current<sup>3</sup> Inductance drop 30% at rated current

All electrical characteristics data is referenced to 25°C.

## DC-Superposed Characteristics

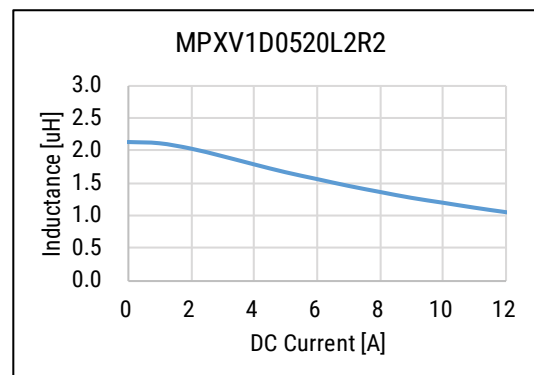
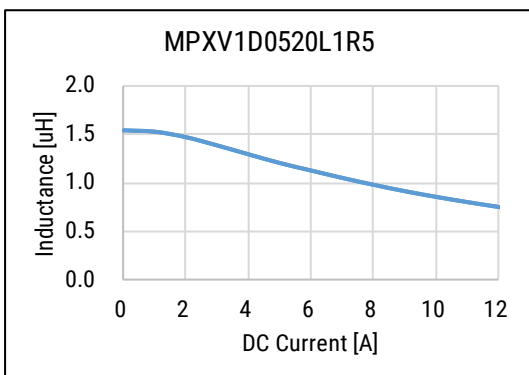
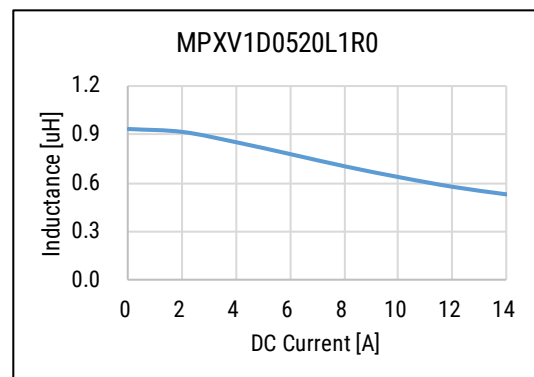
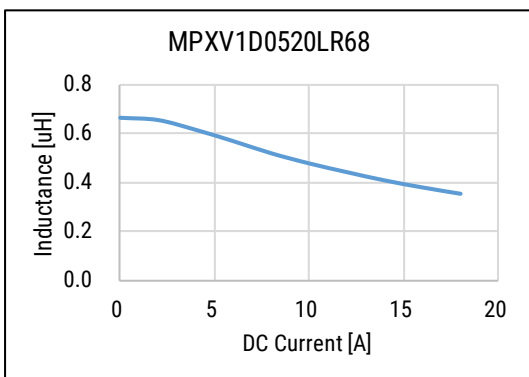
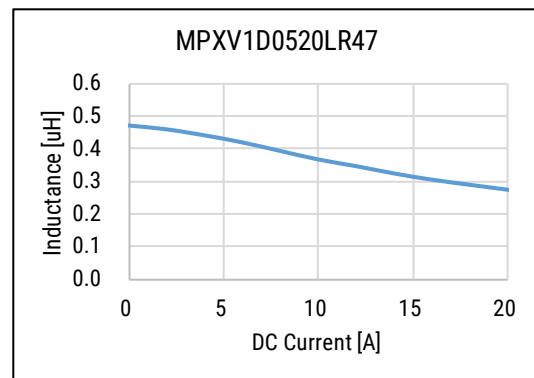
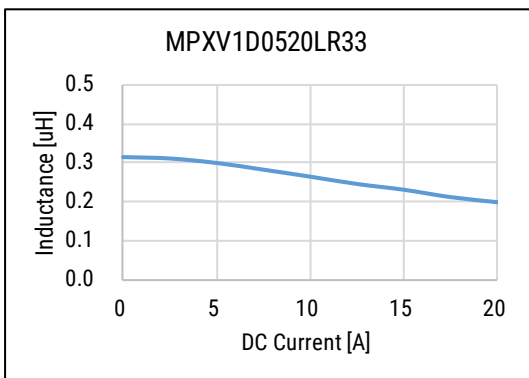
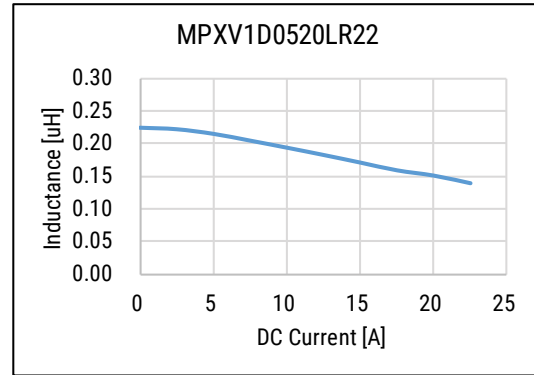
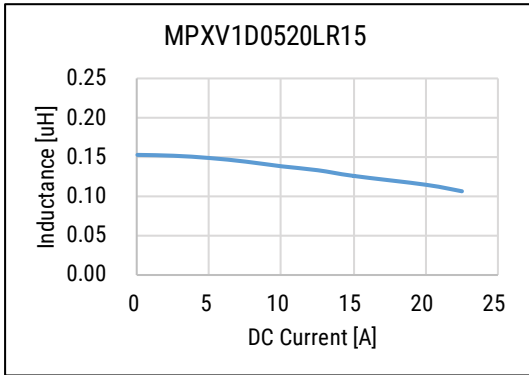



## DC-Superposed Characteristics cont.

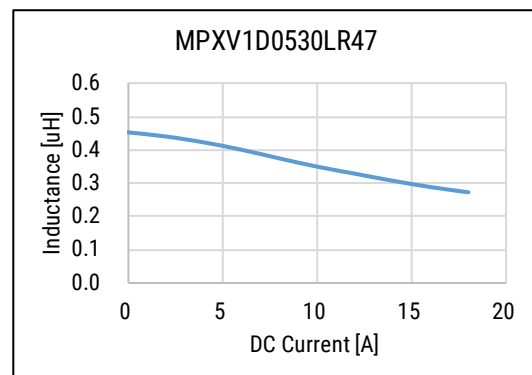
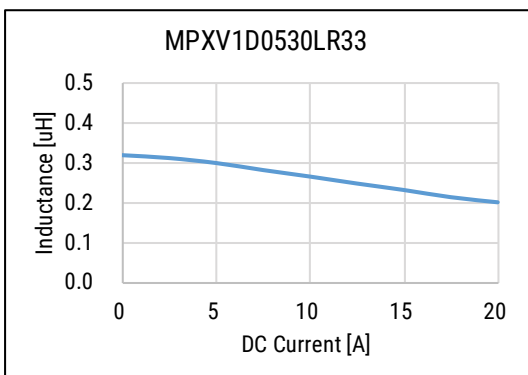
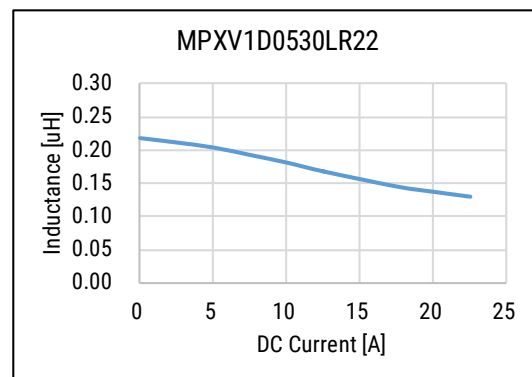
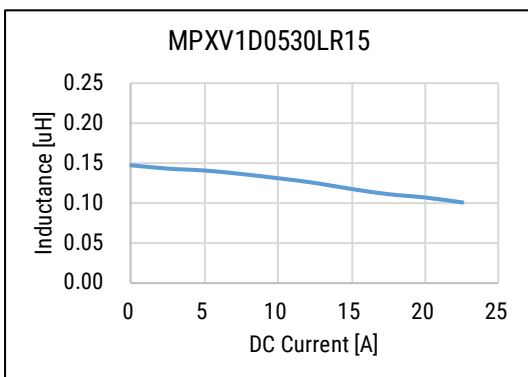
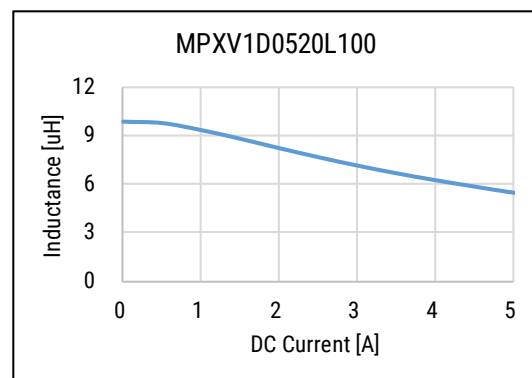
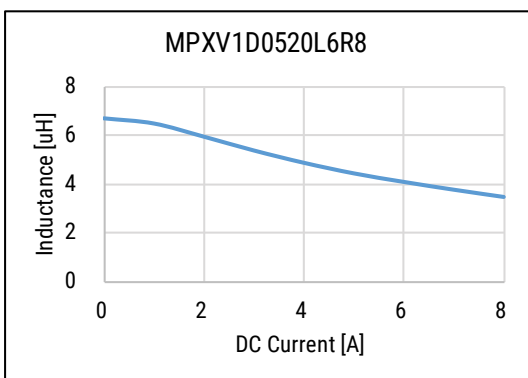
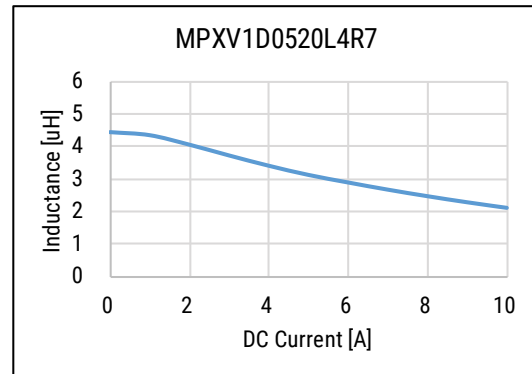
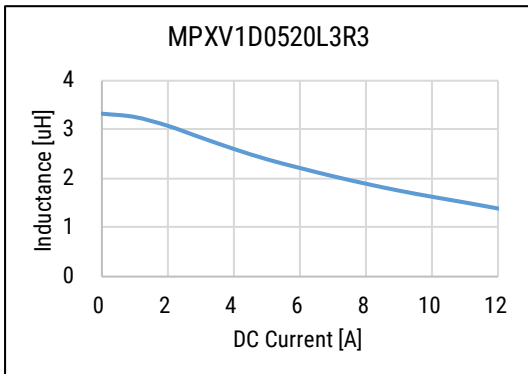

## DC-Superposed Characteristics cont.

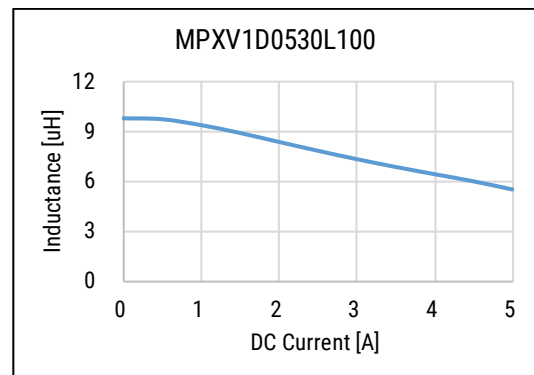
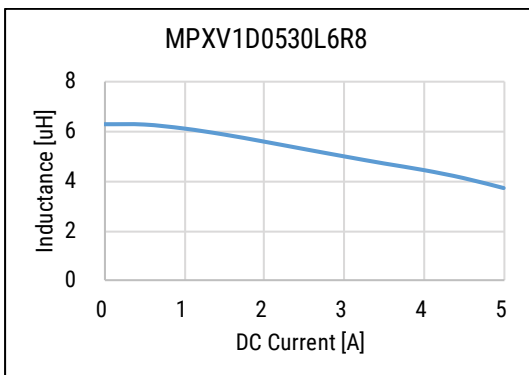
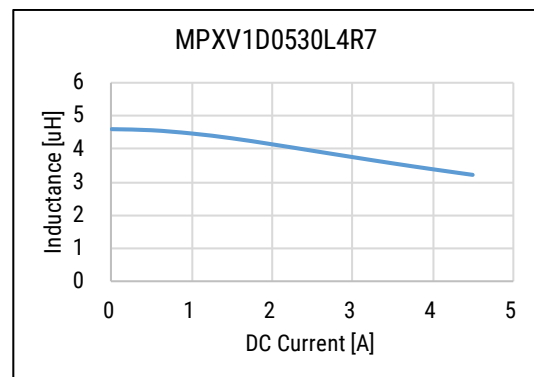
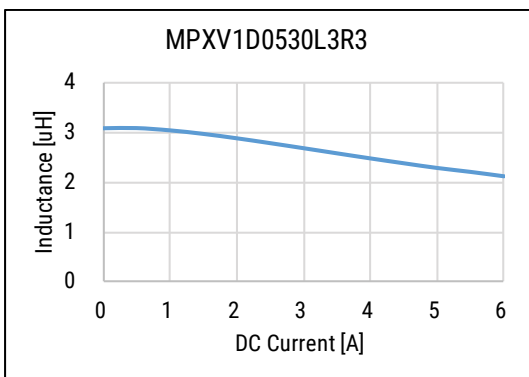
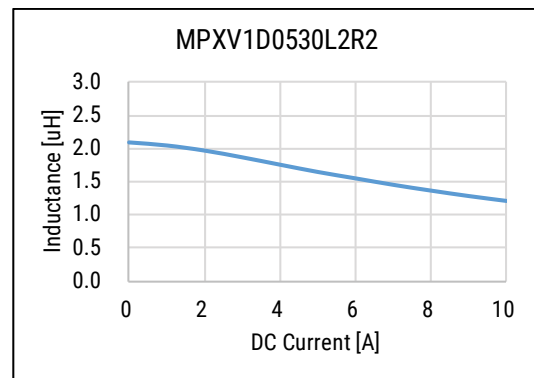
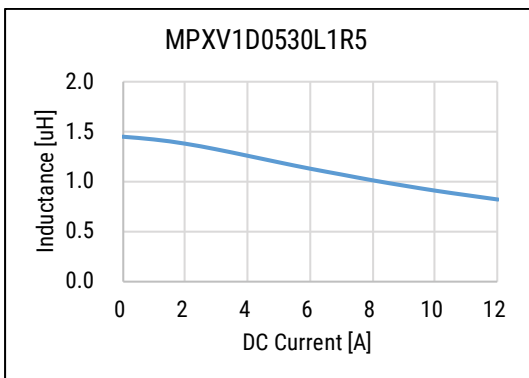
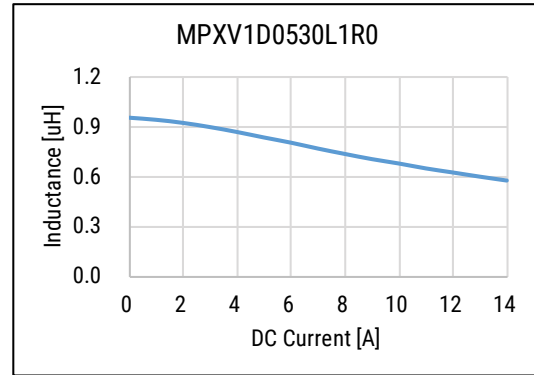
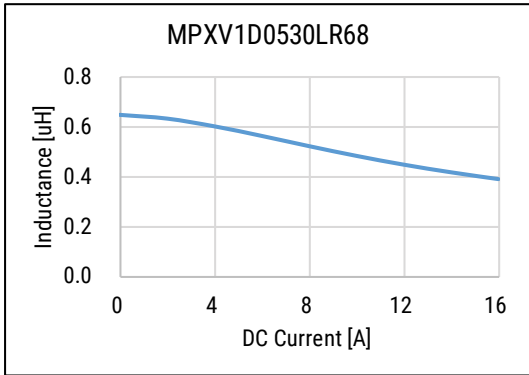

## DC-Superposed Characteristics cont.

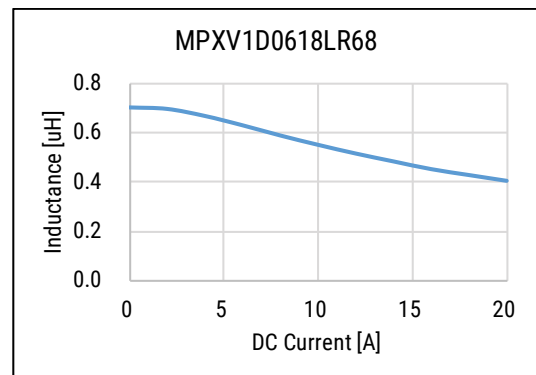
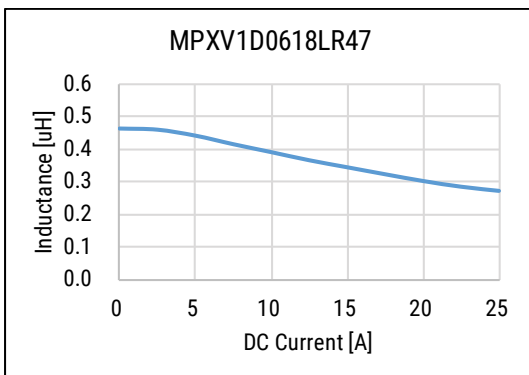
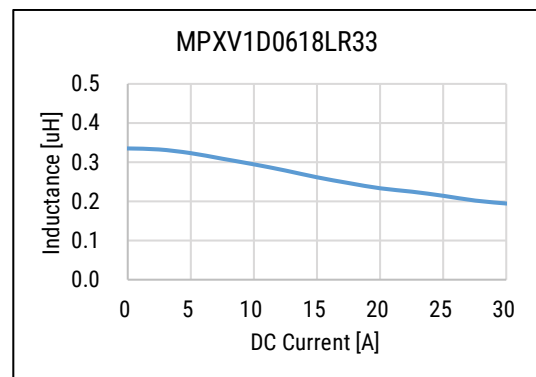
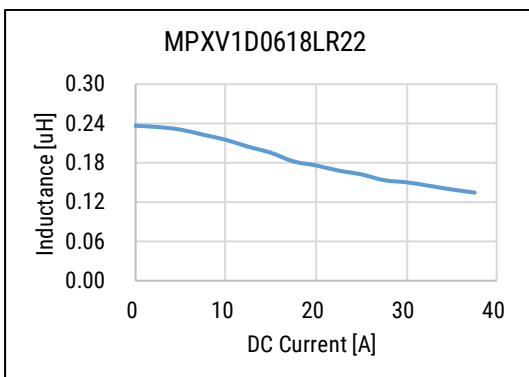
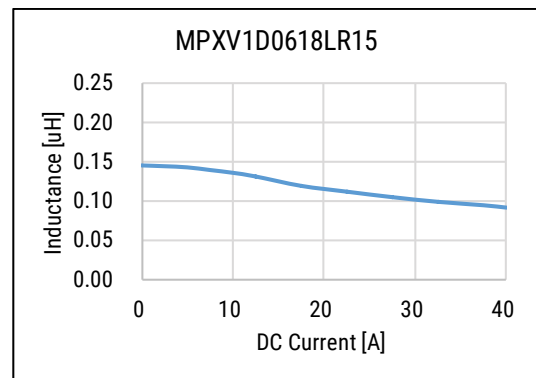
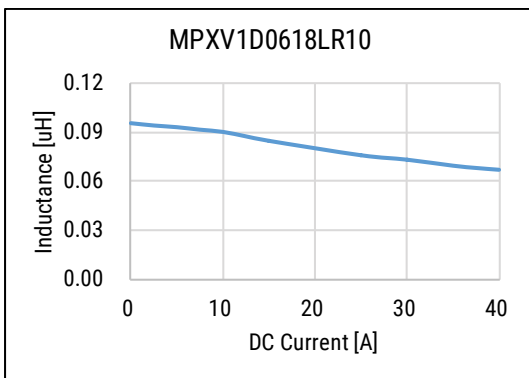
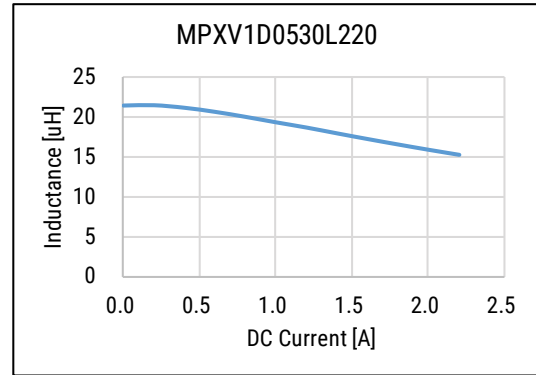
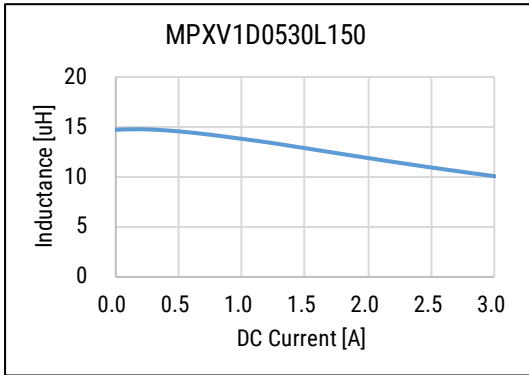

## DC-Superposed Characteristics cont.

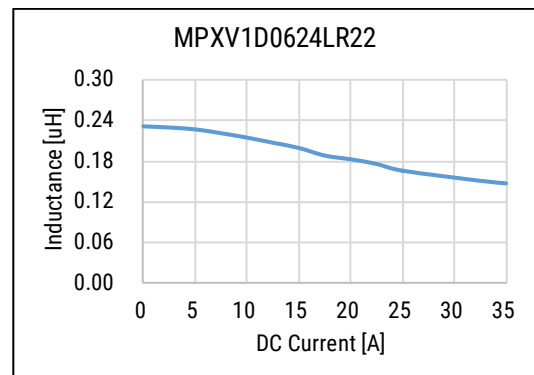
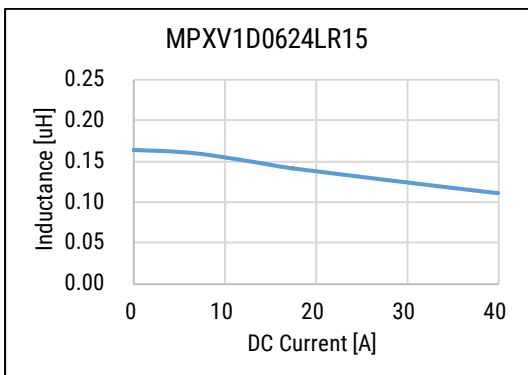
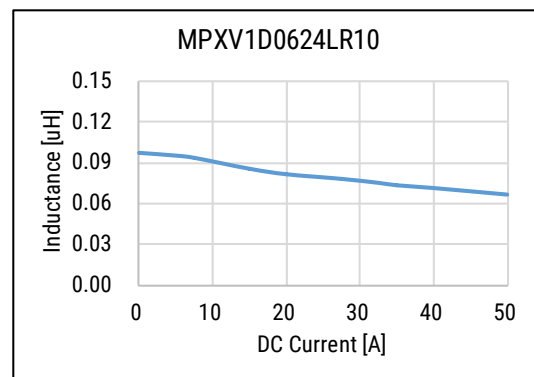
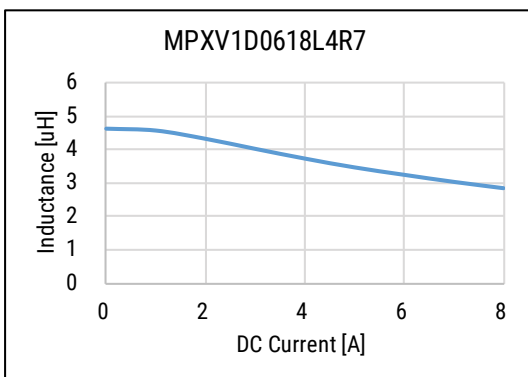
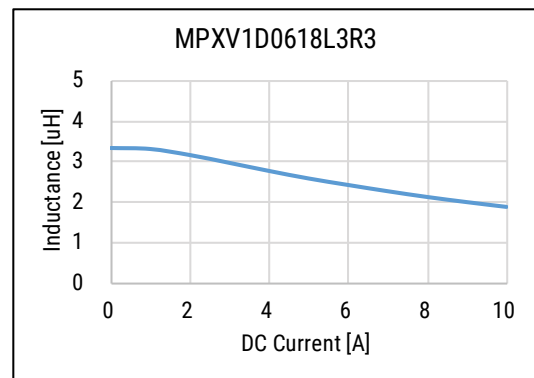
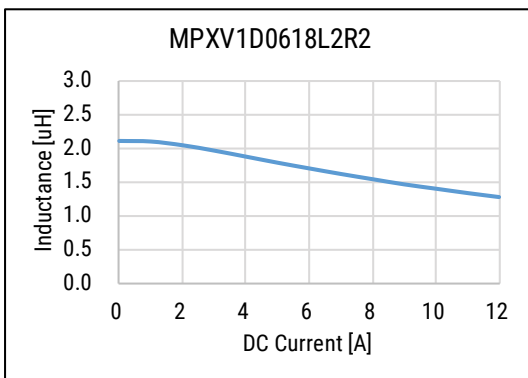
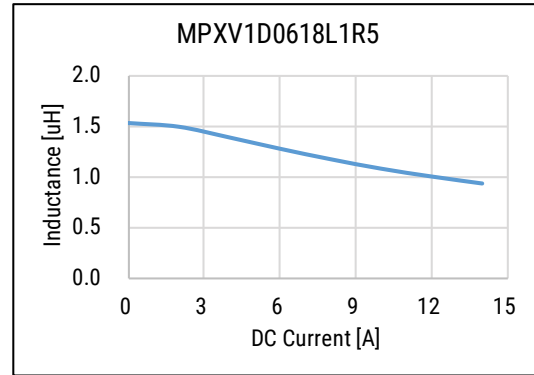
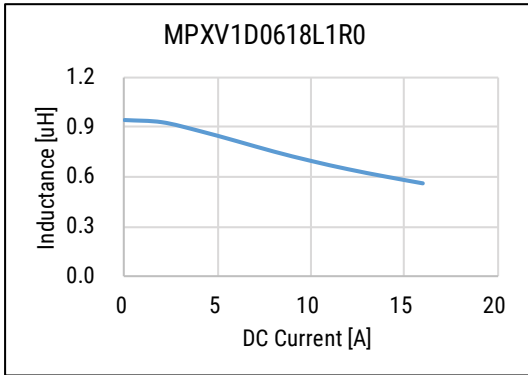

## DC-Superposed Characteristics cont.

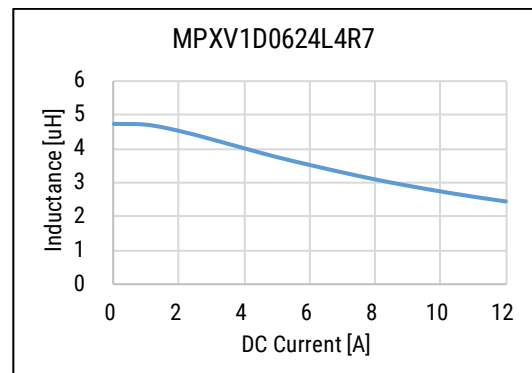
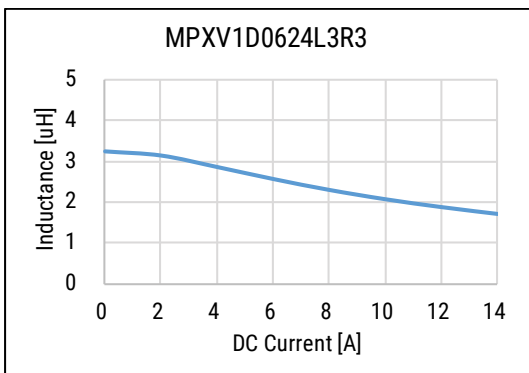
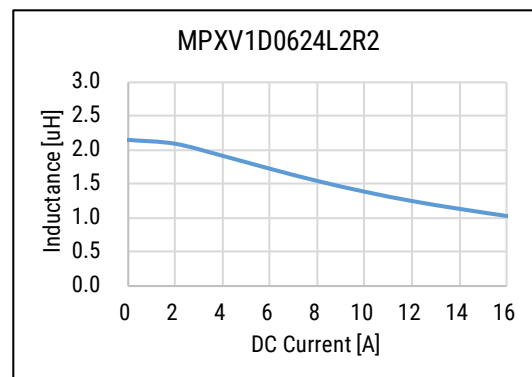
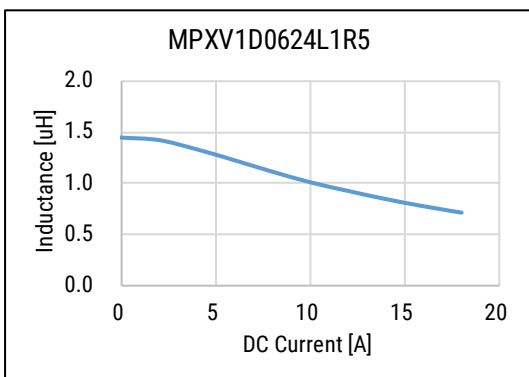
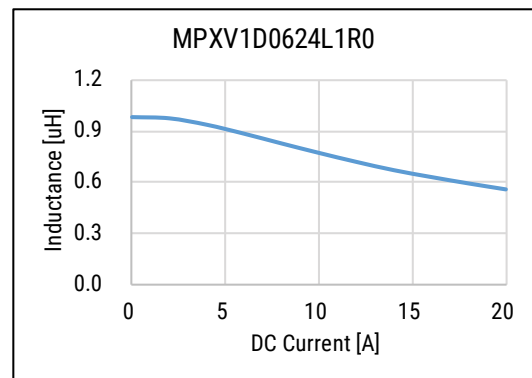
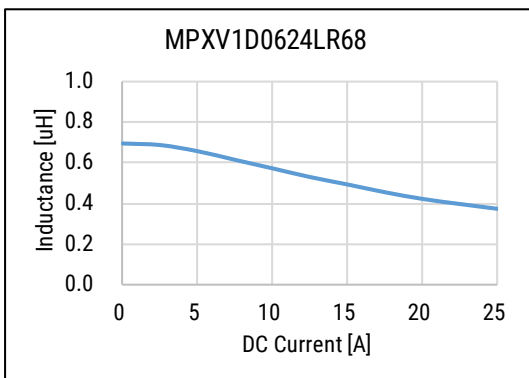
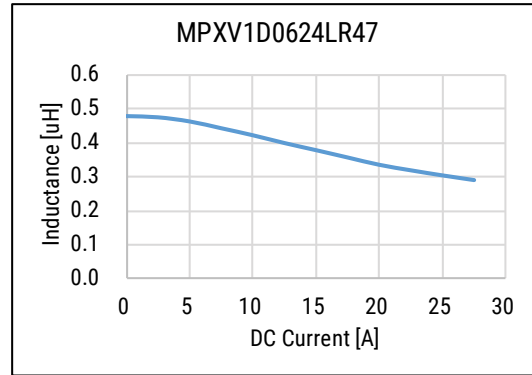
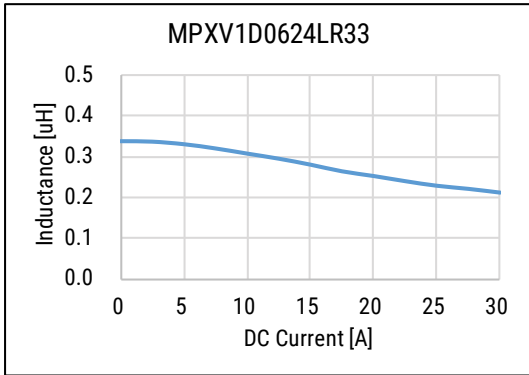

## DC-Superposed Characteristics cont.

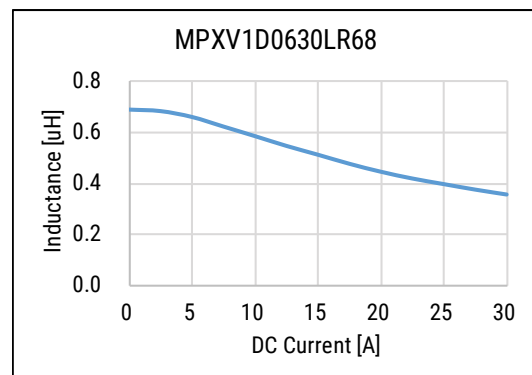
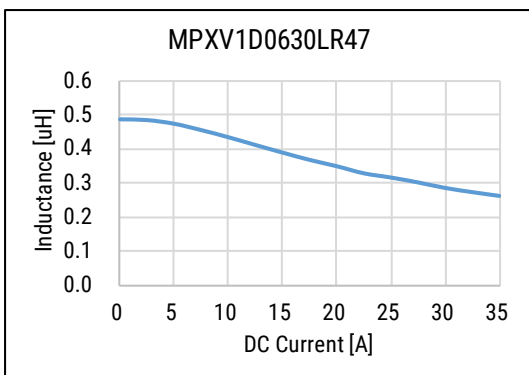
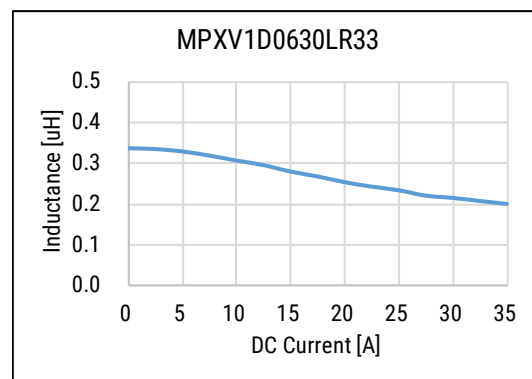
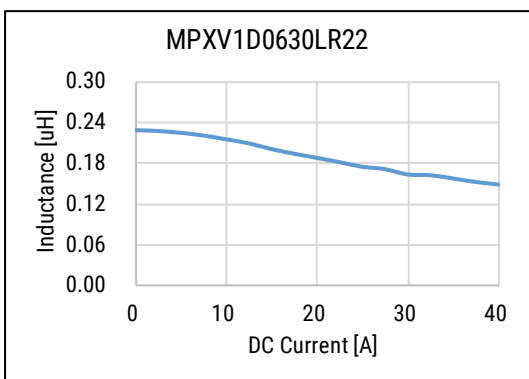
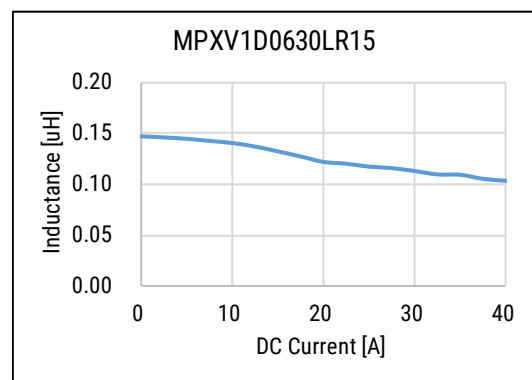
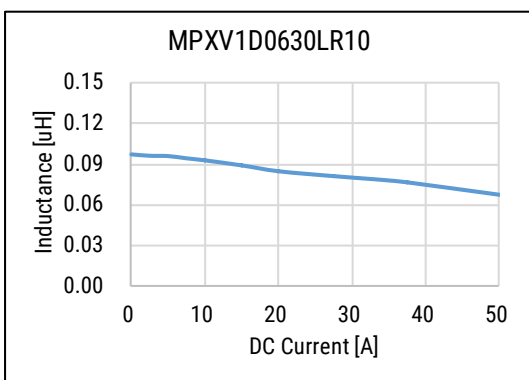
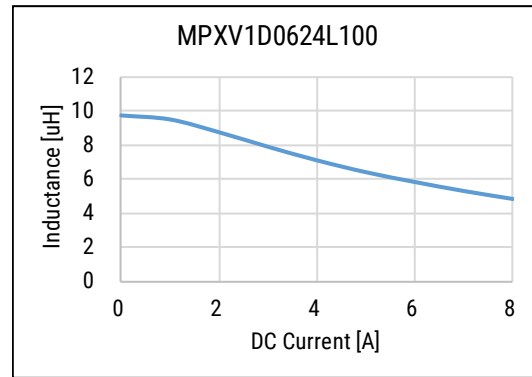
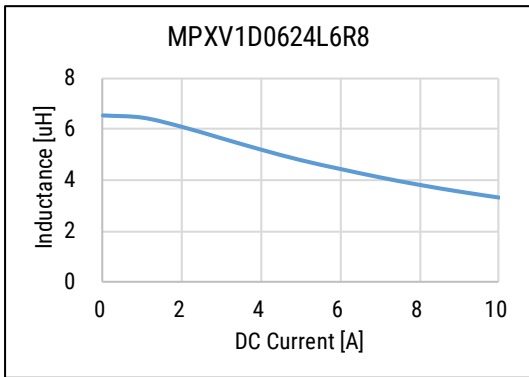

## DC-Superposed Characteristics cont.

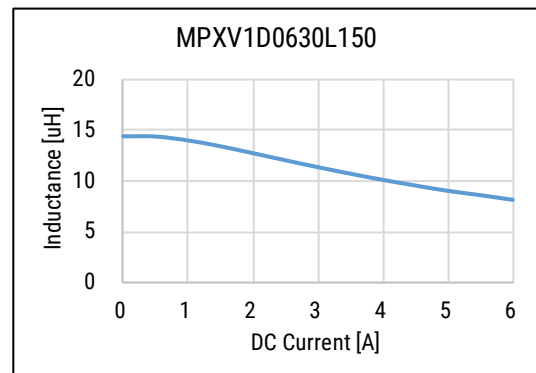
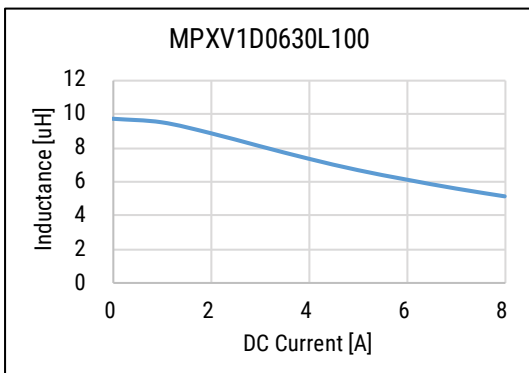
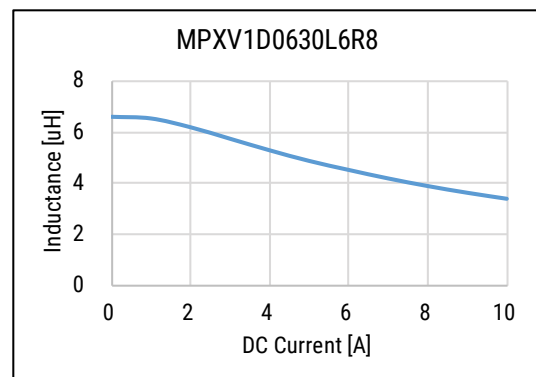
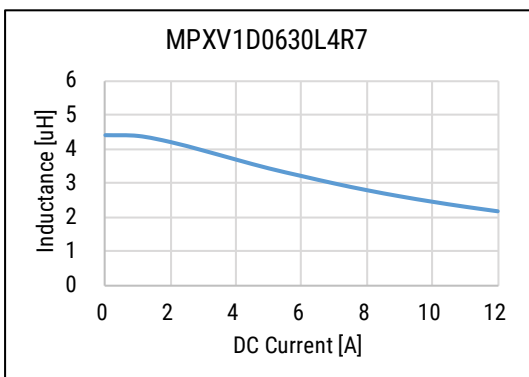
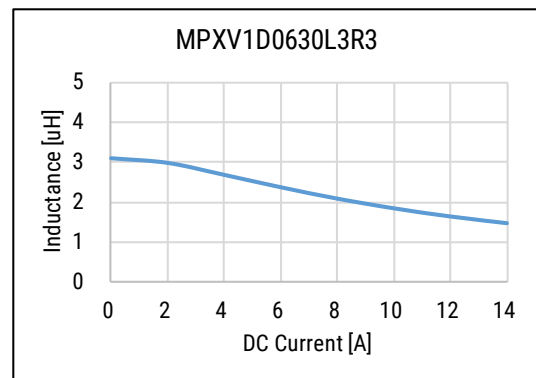
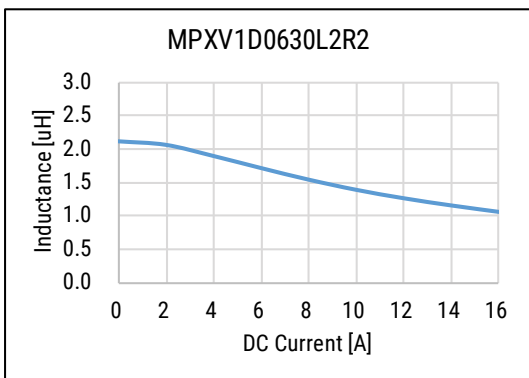
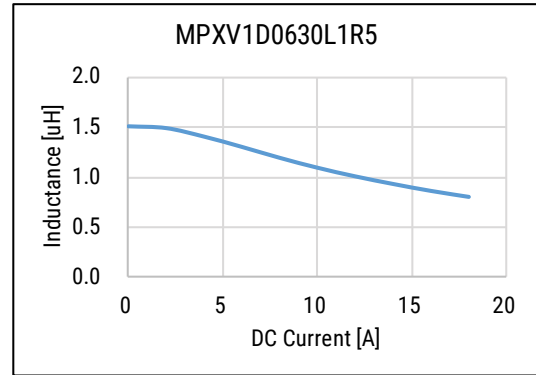
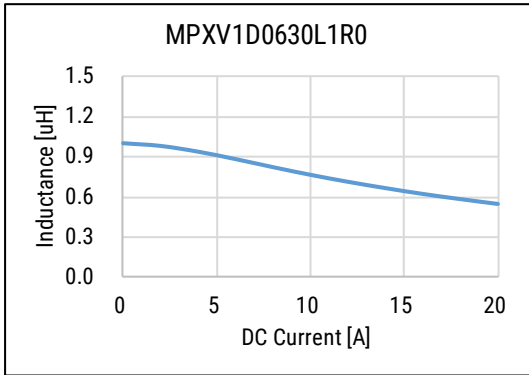

## DC-Superposed Characteristics cont.

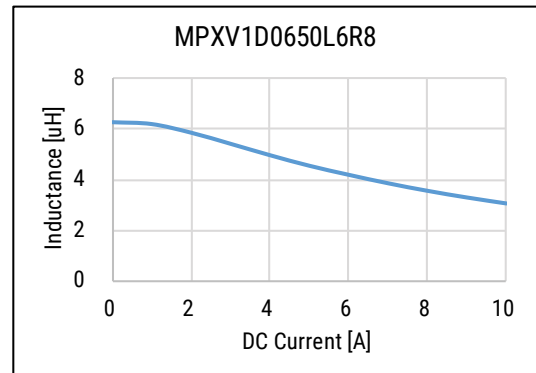
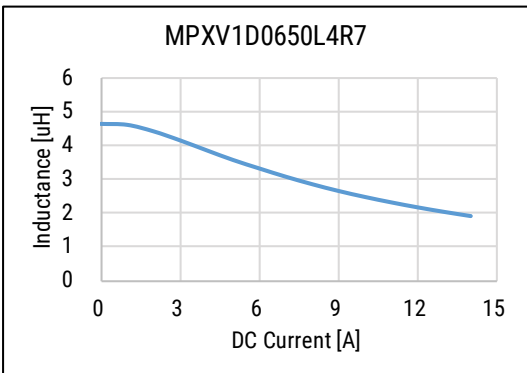
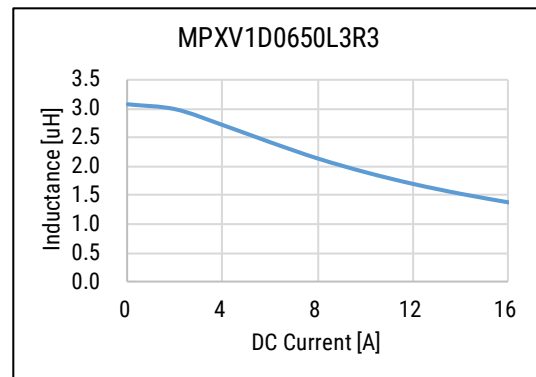
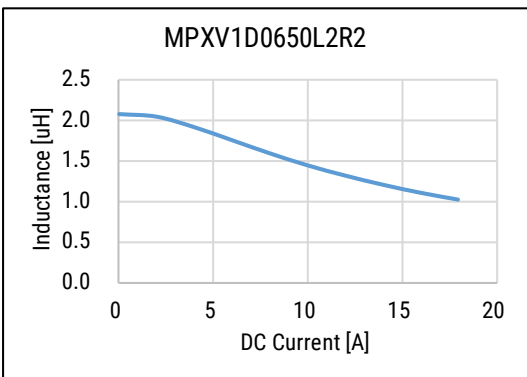
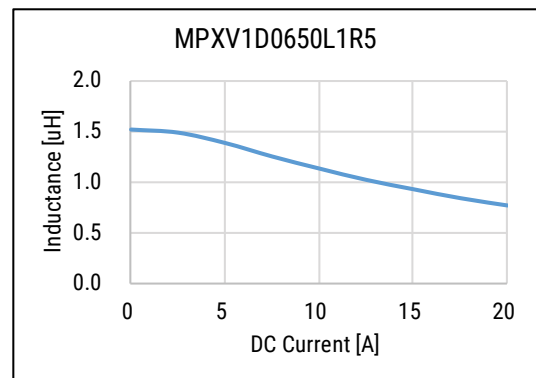
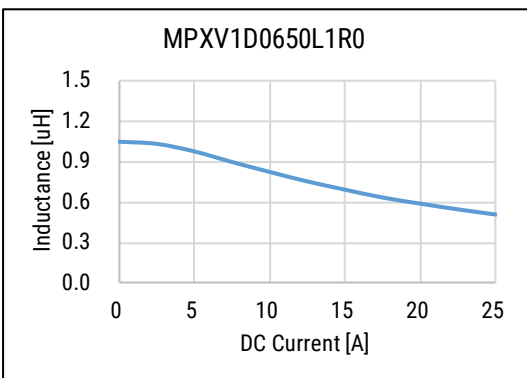
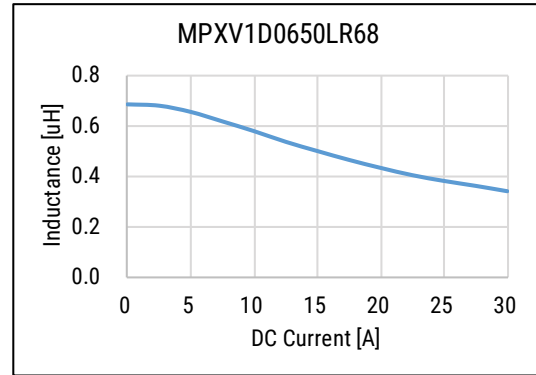
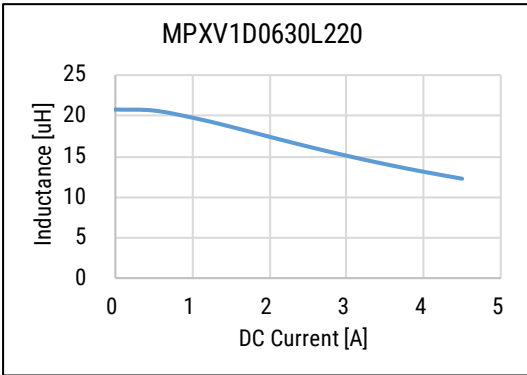



## DC-Superposed Characteristics cont.

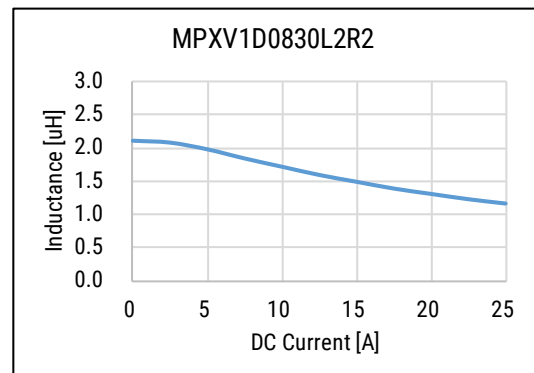
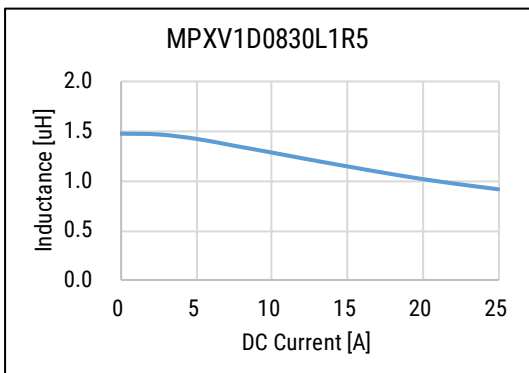
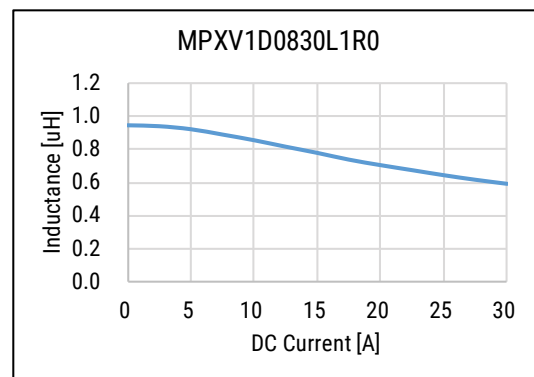
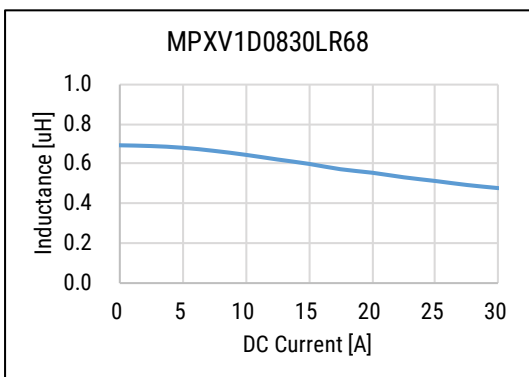
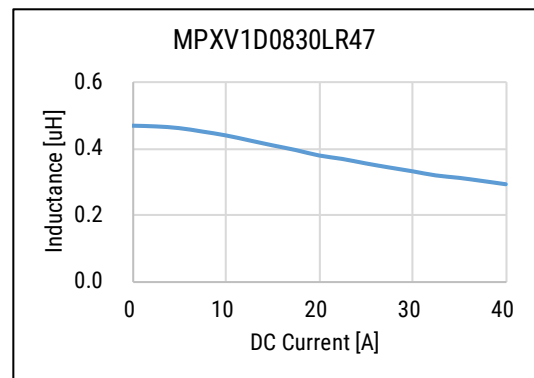
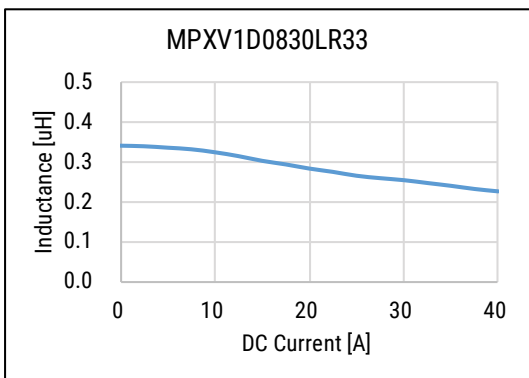
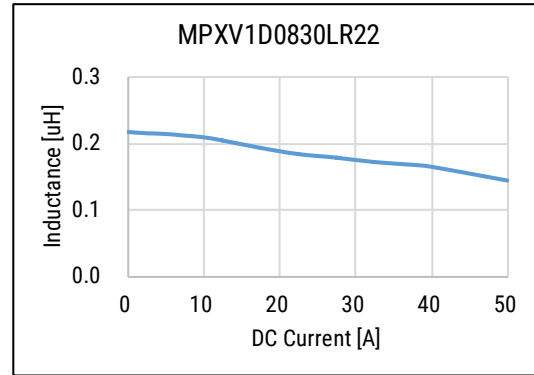
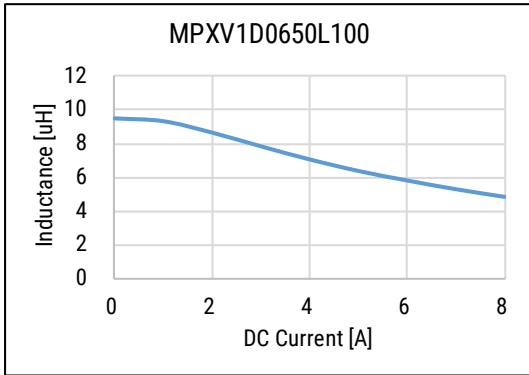

## DC-Superposed Characteristics cont.

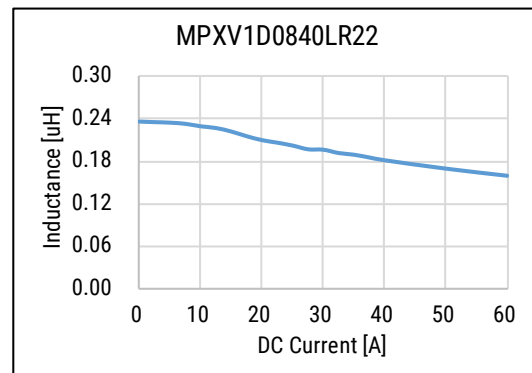
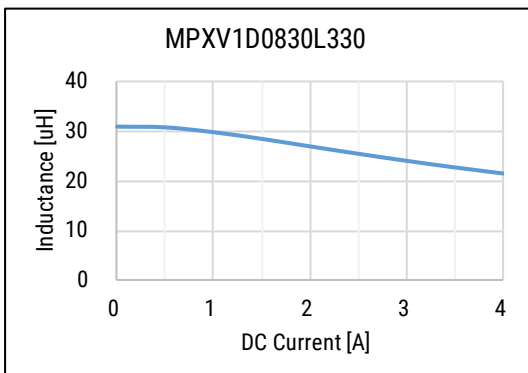
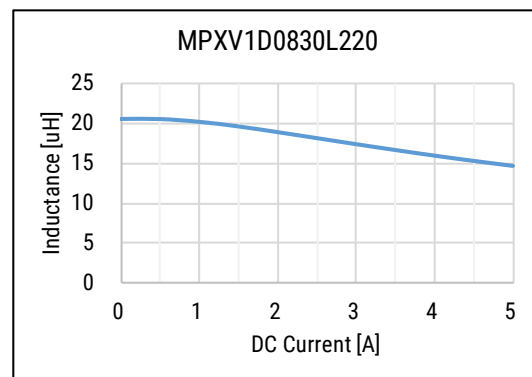
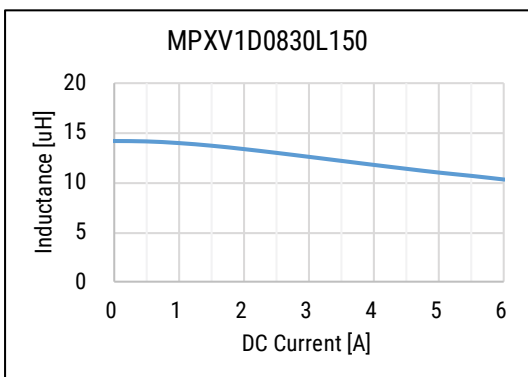
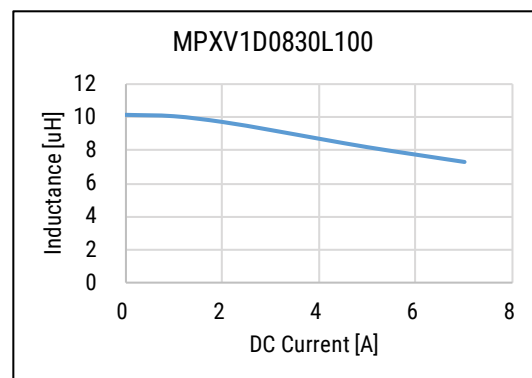
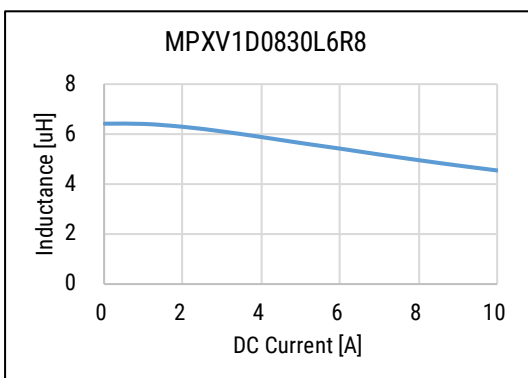
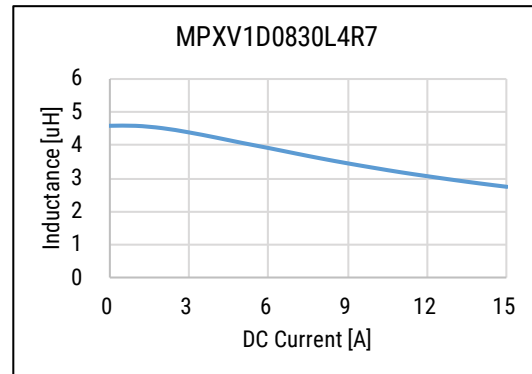
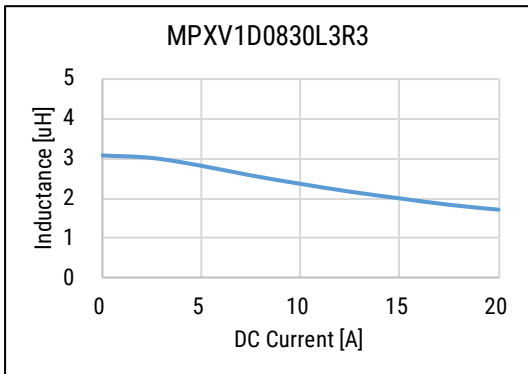

## DC-Superposed Characteristics cont.

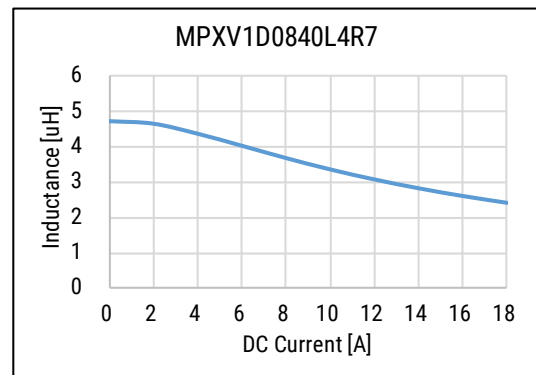
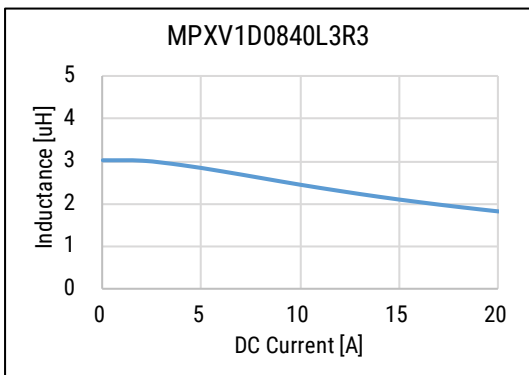
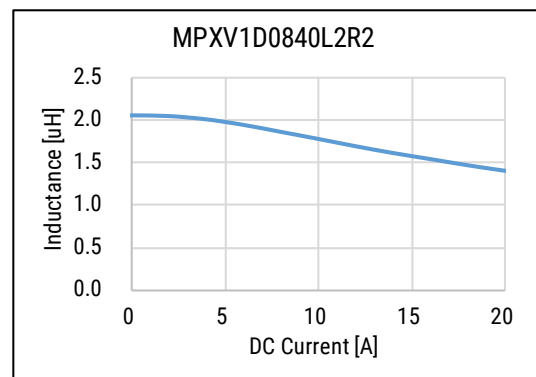
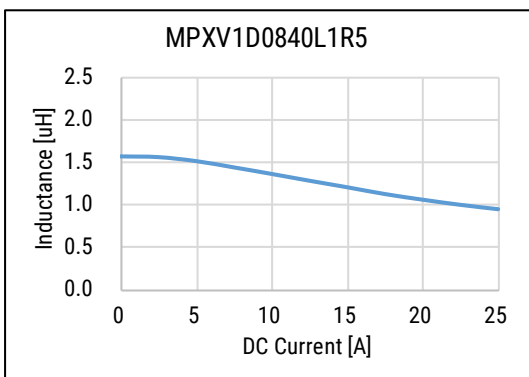
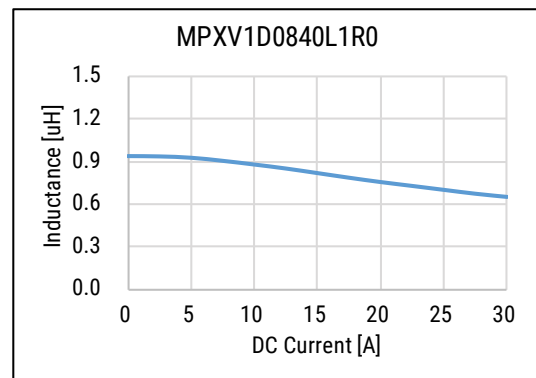
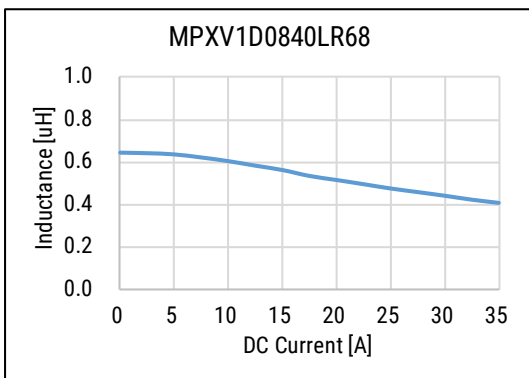
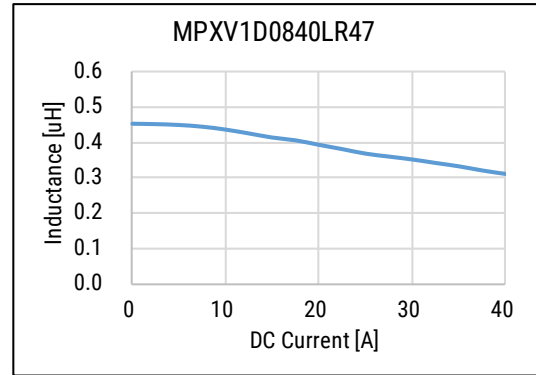
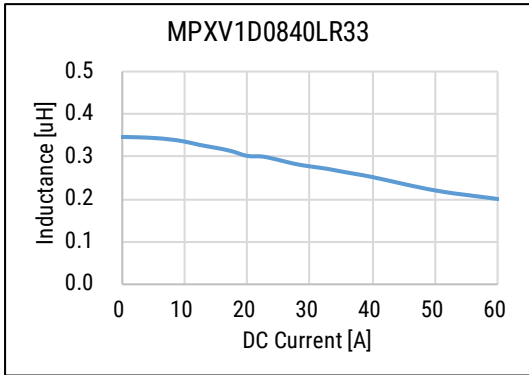

## DC-Superposed Characteristics cont.

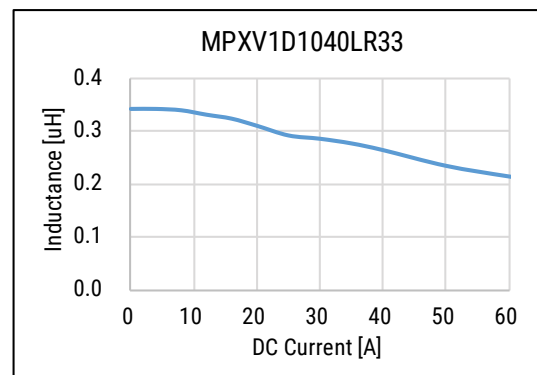
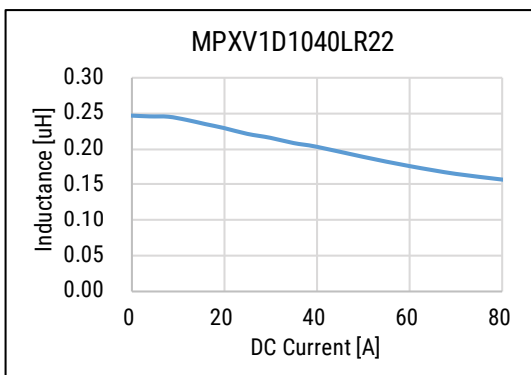
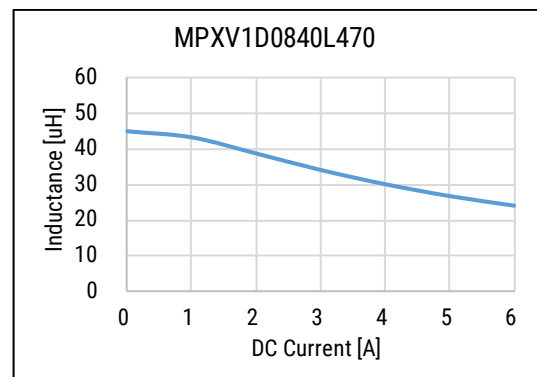
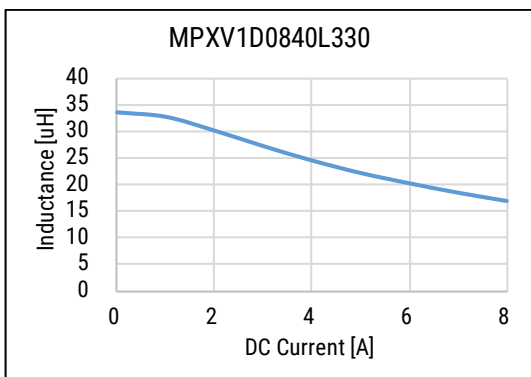
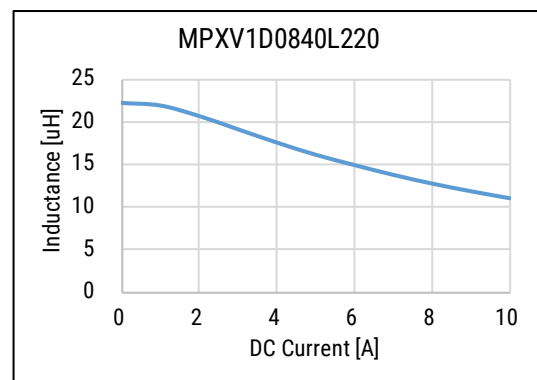
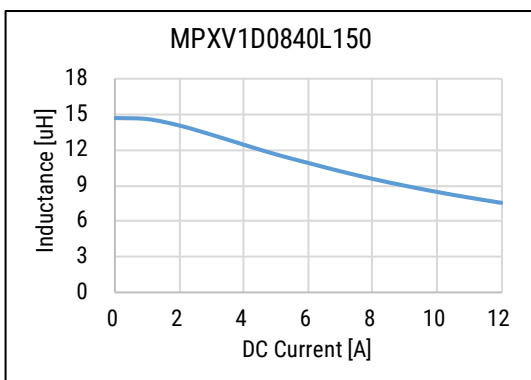
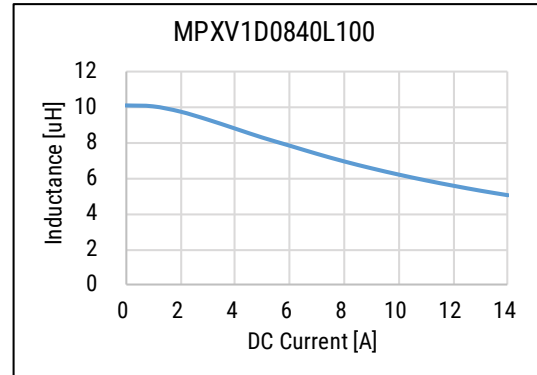
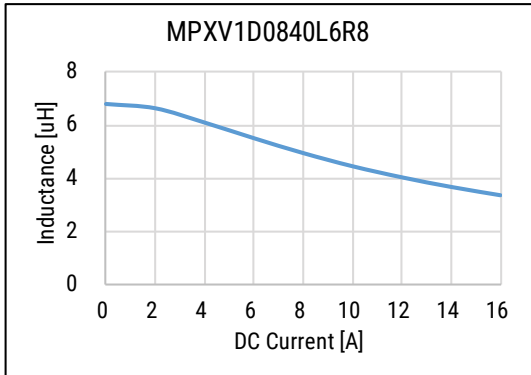

## DC-Superposed Characteristics cont.

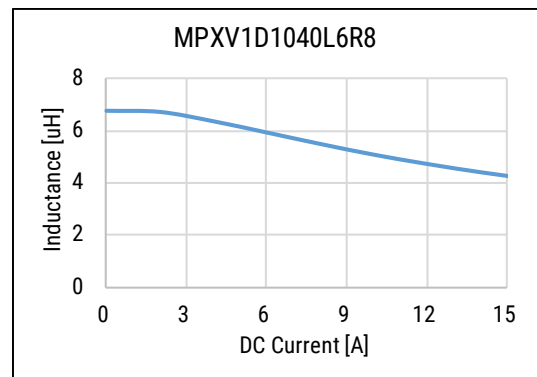
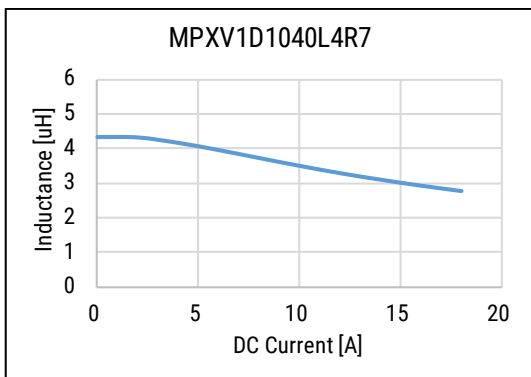
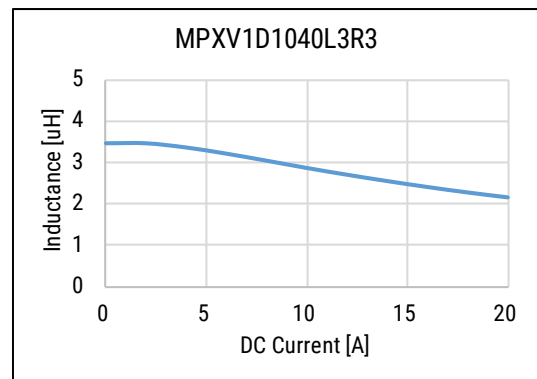
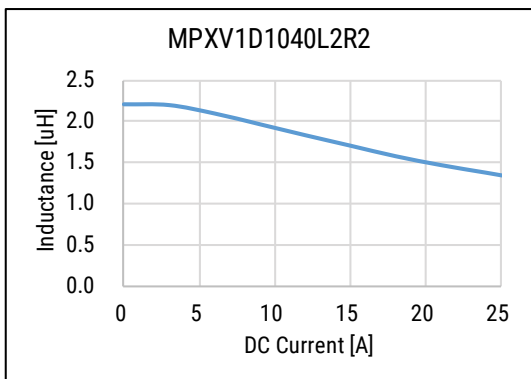
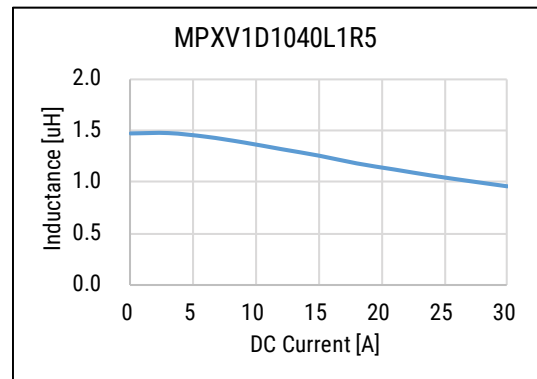
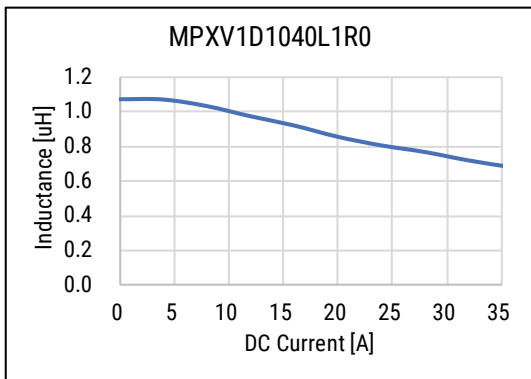
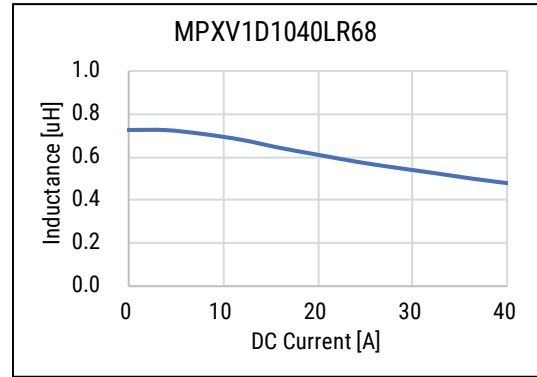
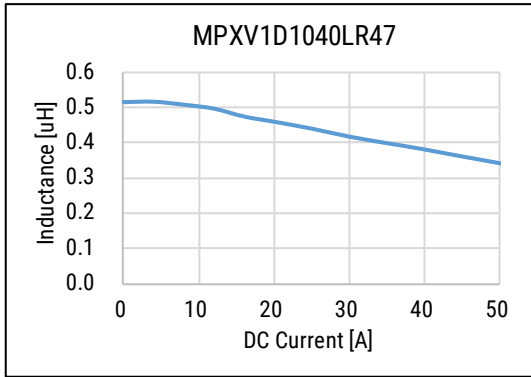

## DC-Superposed Characteristics cont.

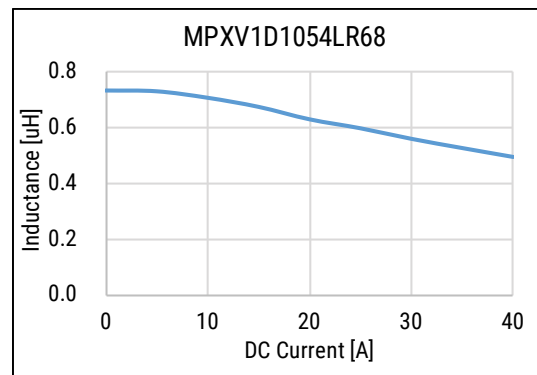
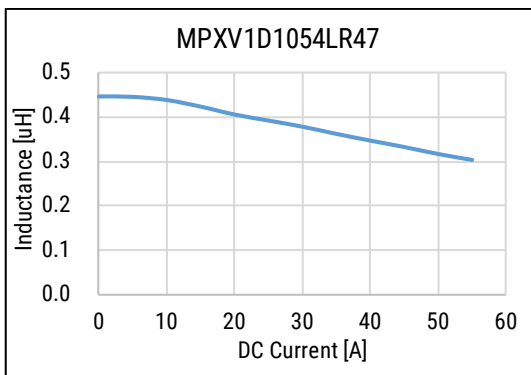
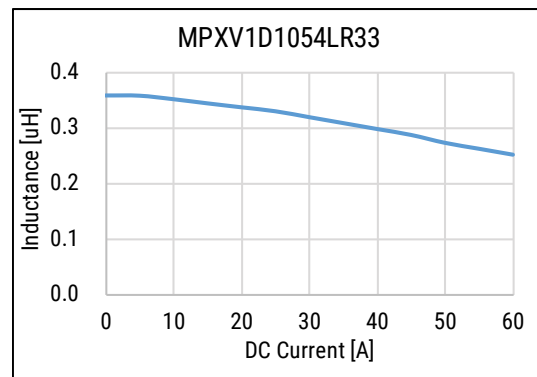
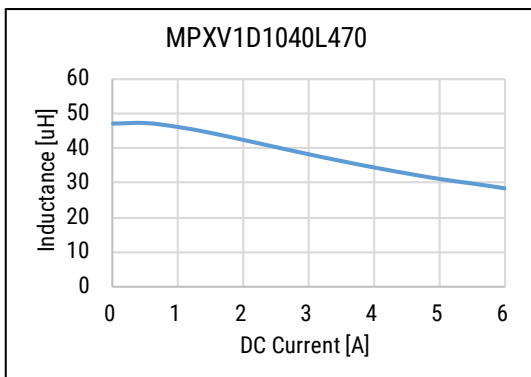
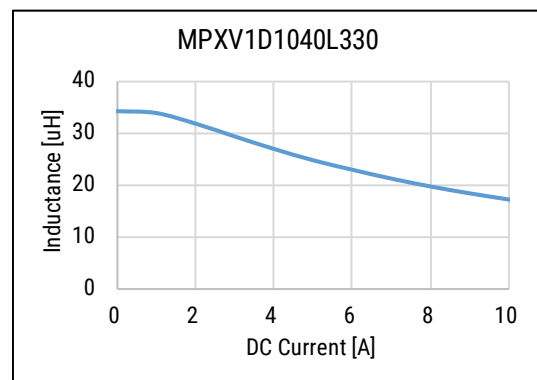
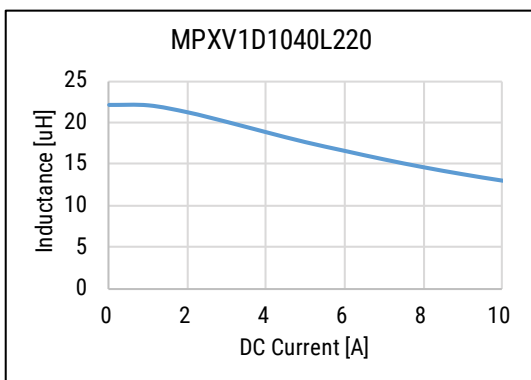
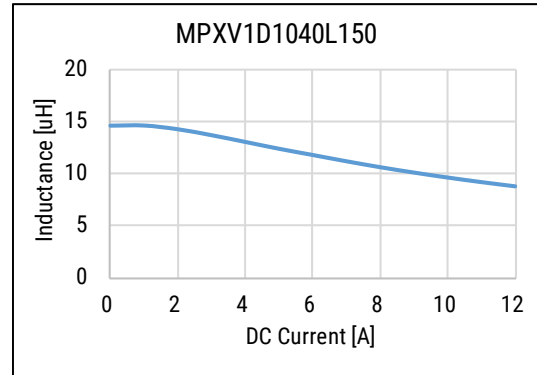
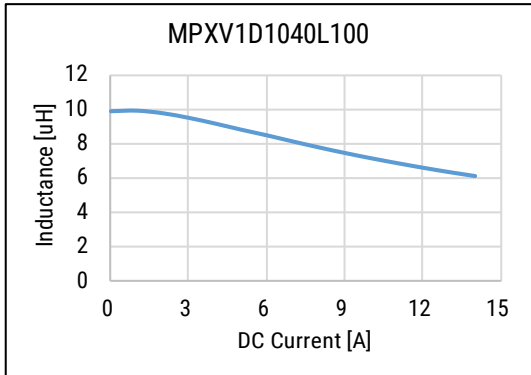

## DC-Superposed Characteristics cont.

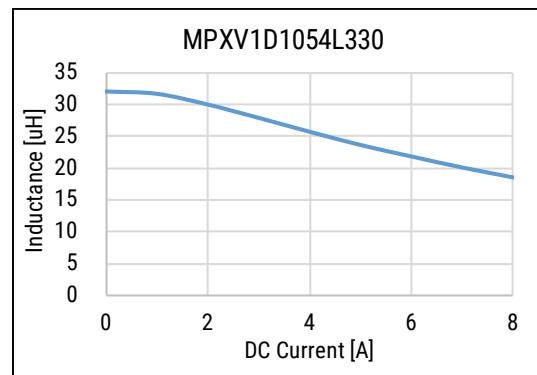
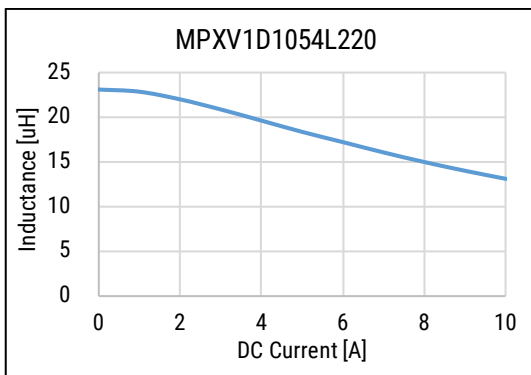
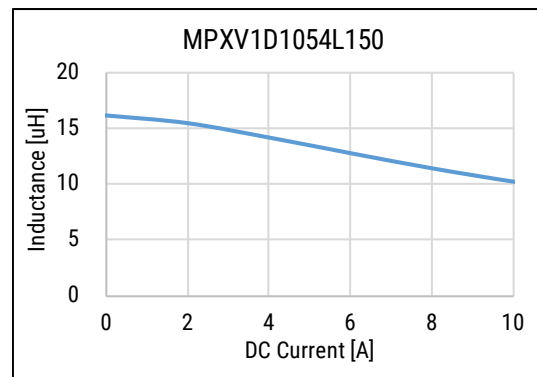
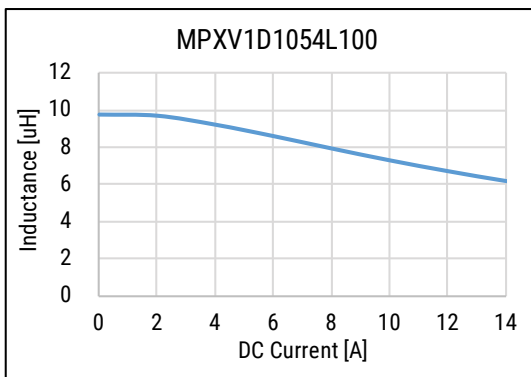
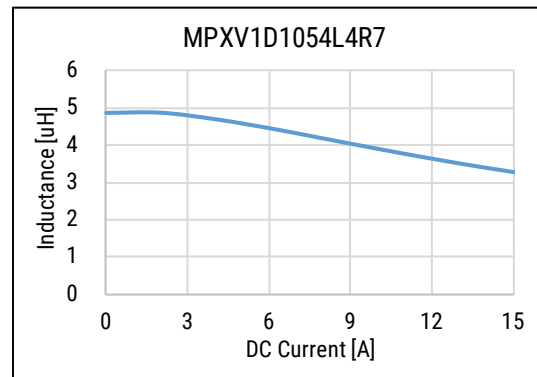
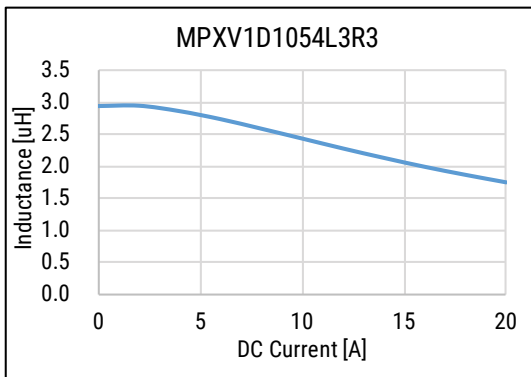
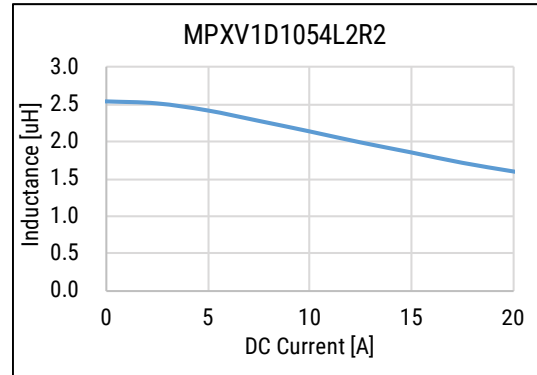
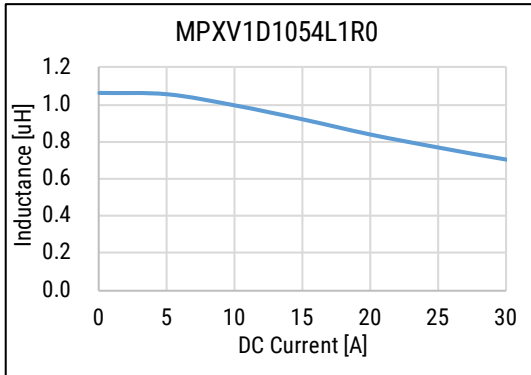

## DC-Superposed Characteristics cont.

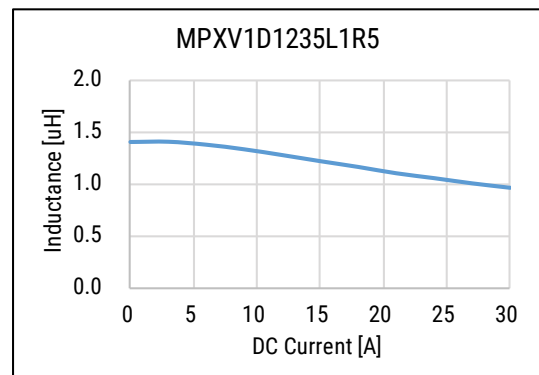
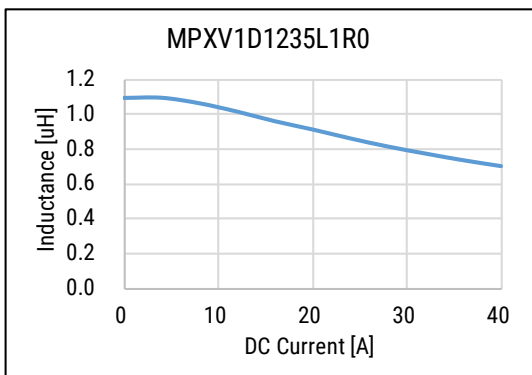
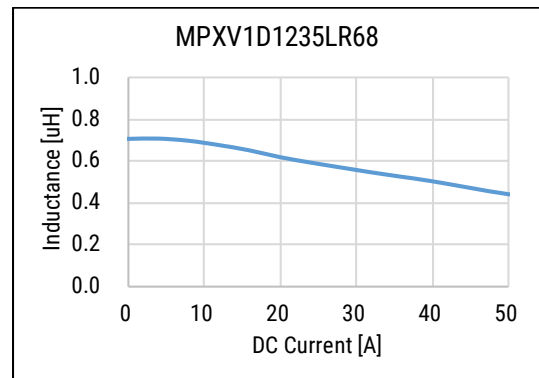
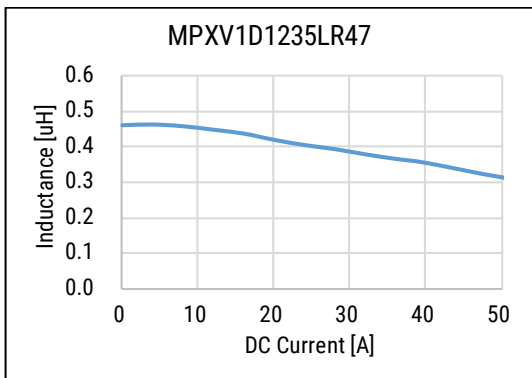
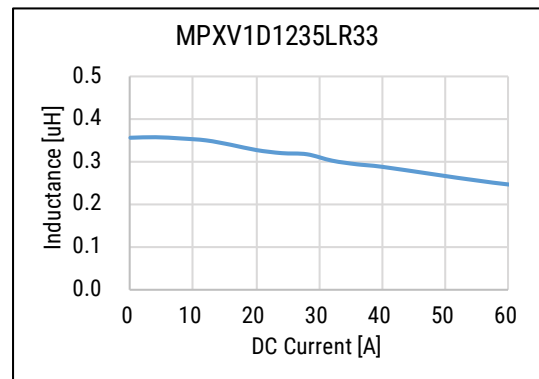
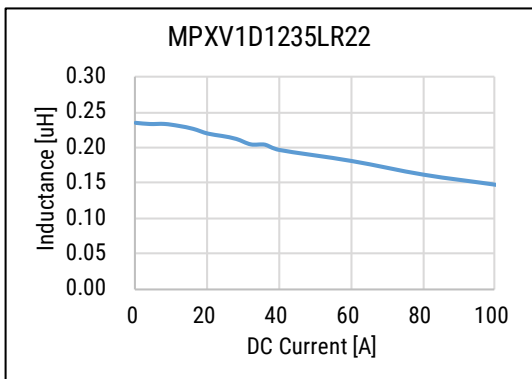
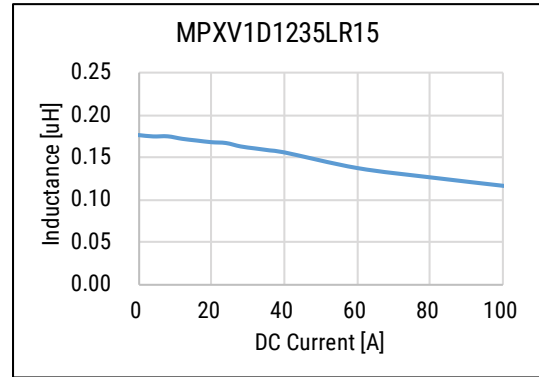
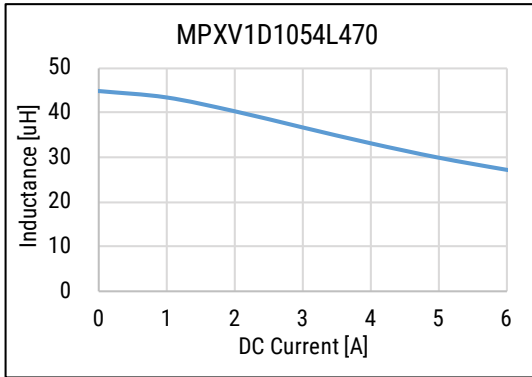



## DC-Superposed Characteristics cont.

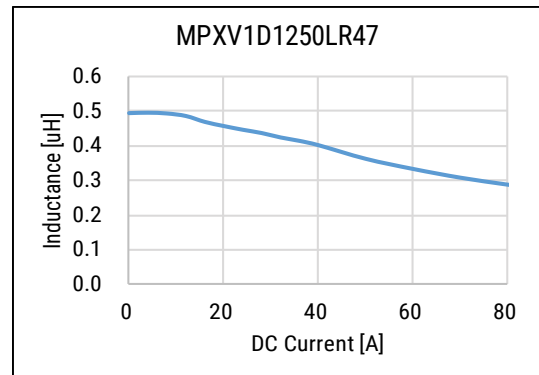
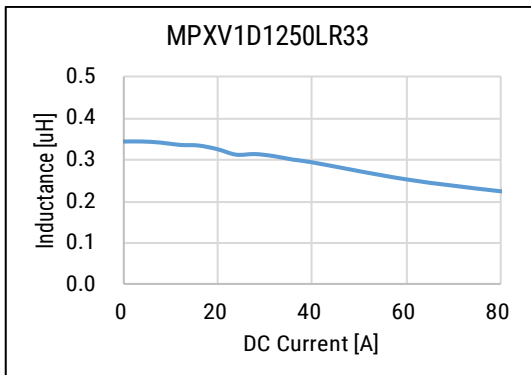
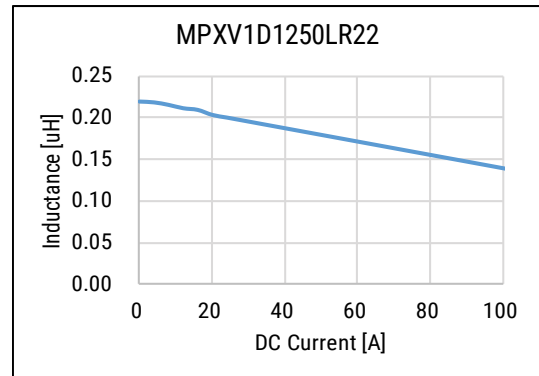
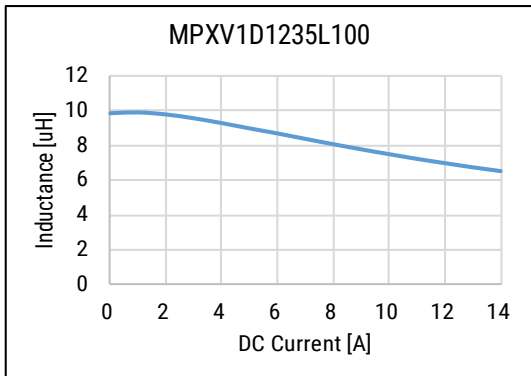
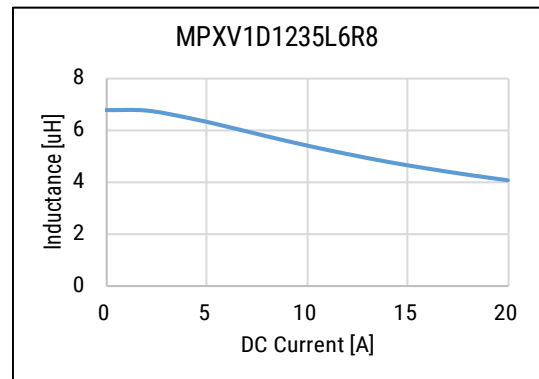
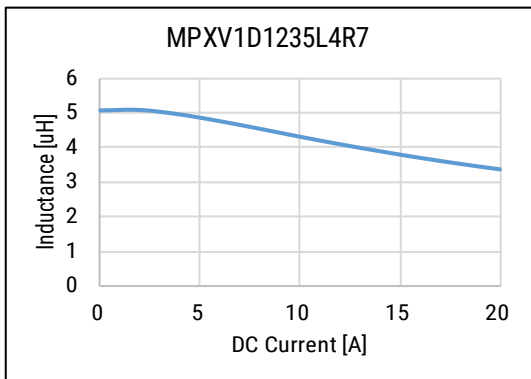
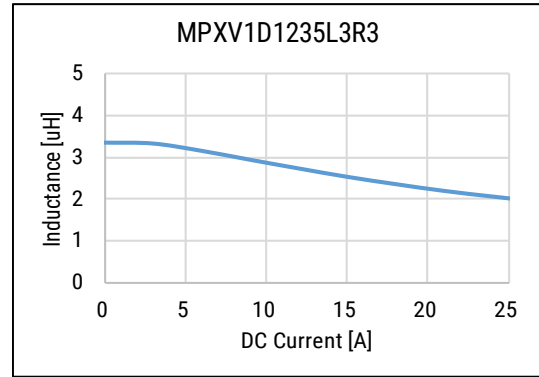
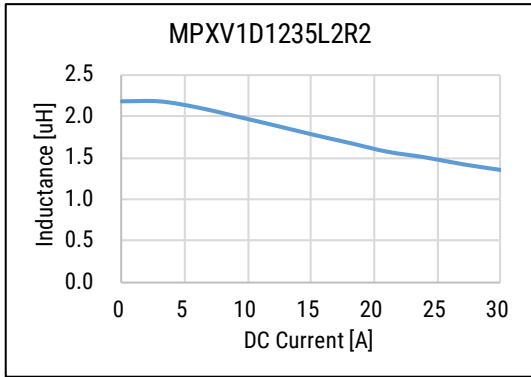

## DC-Superposed Characteristics cont.

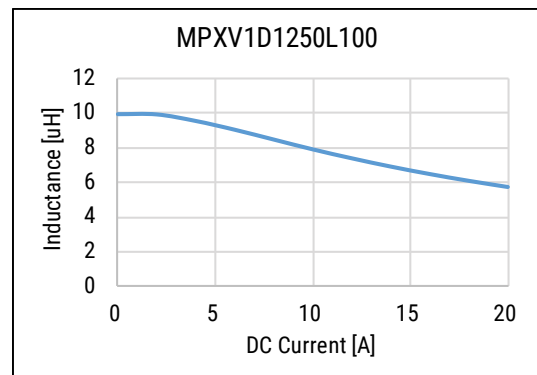
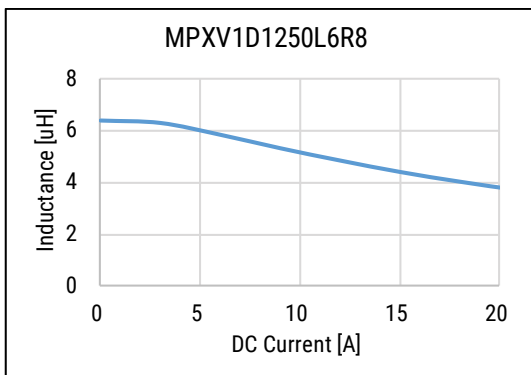
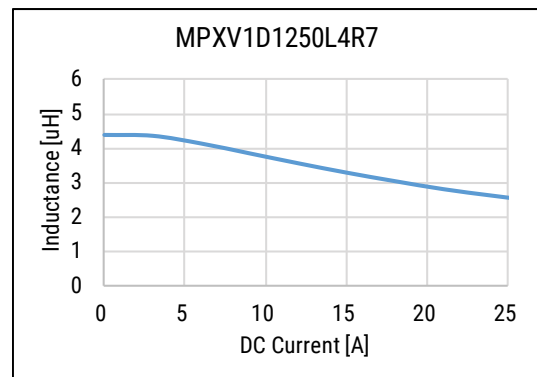
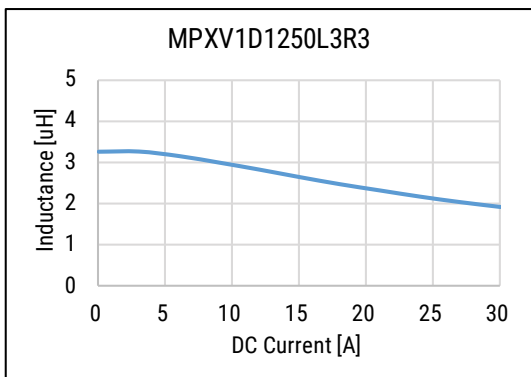
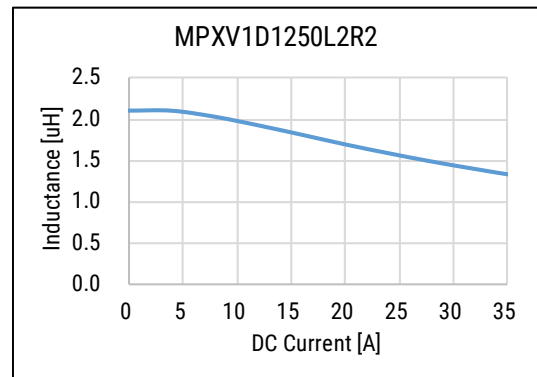
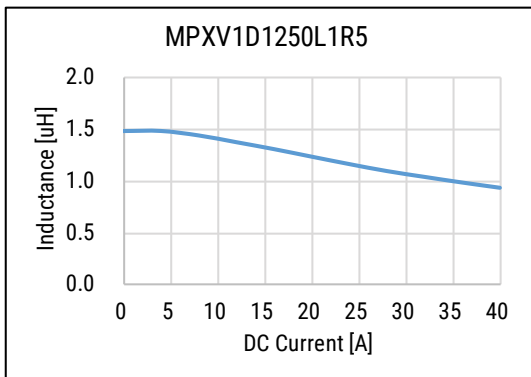
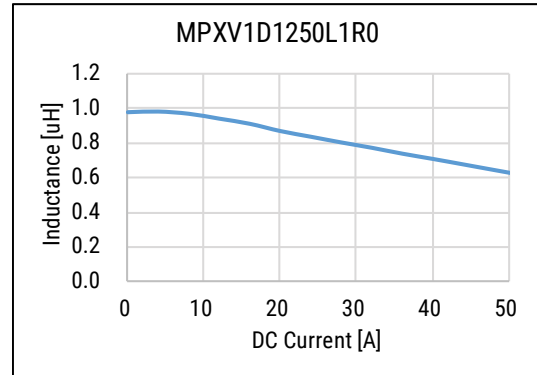
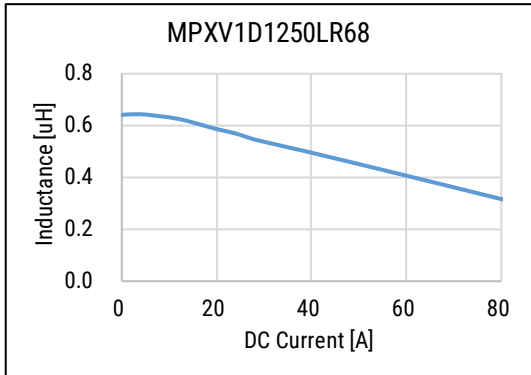

## DC-Superposed Characteristics cont.

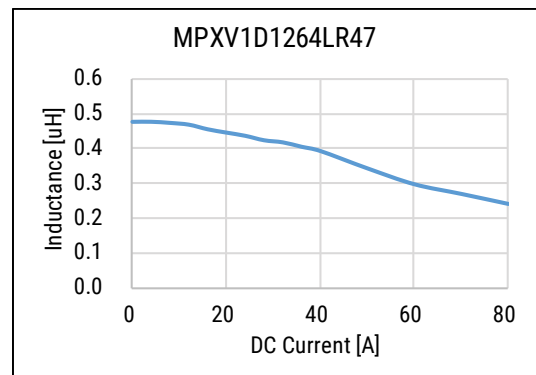
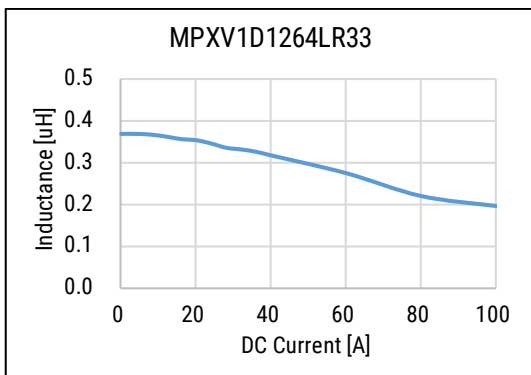
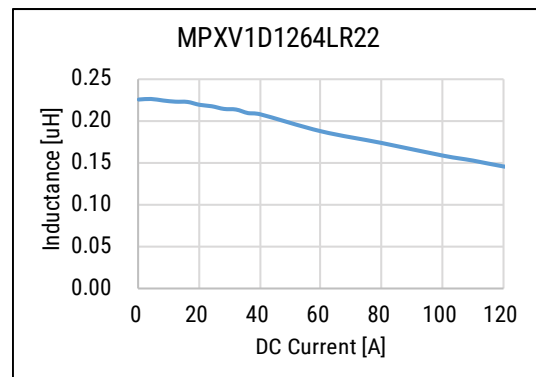
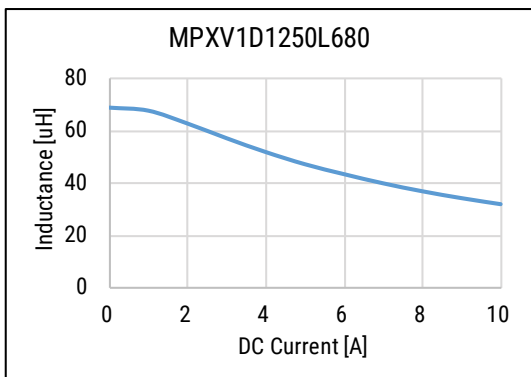
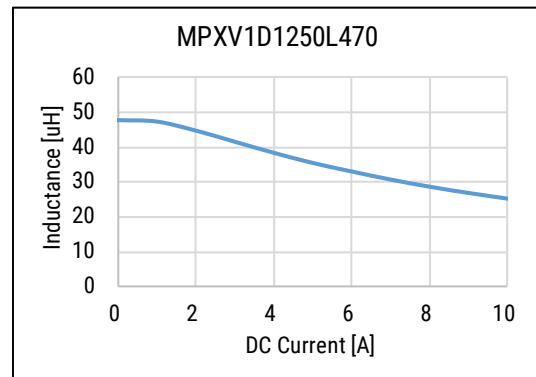
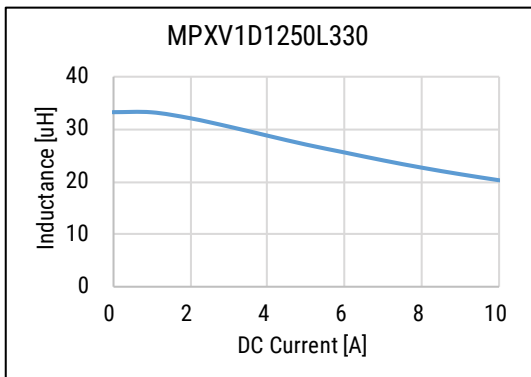
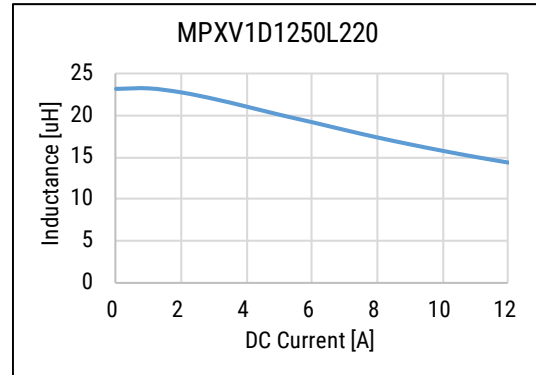
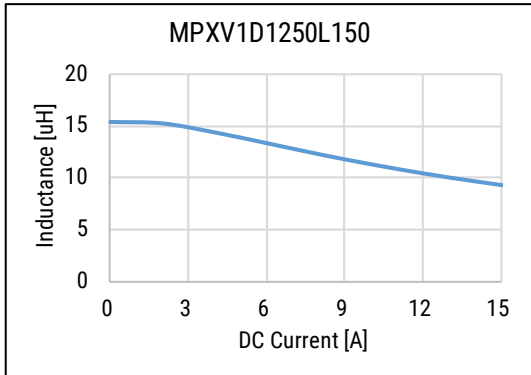

## DC-Superposed Characteristics cont.

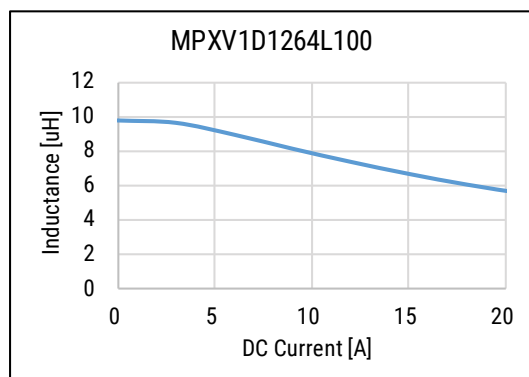
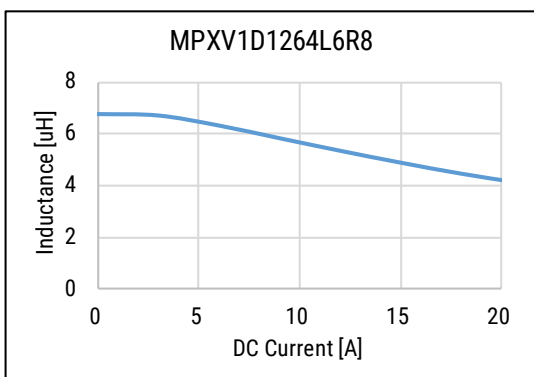
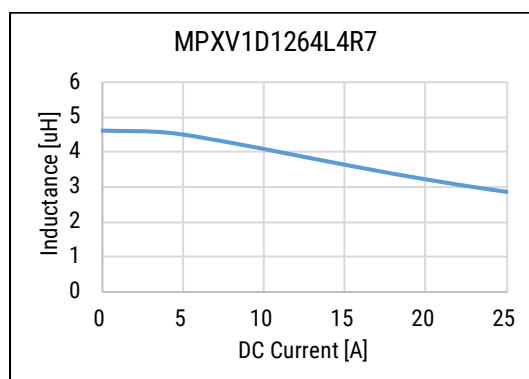
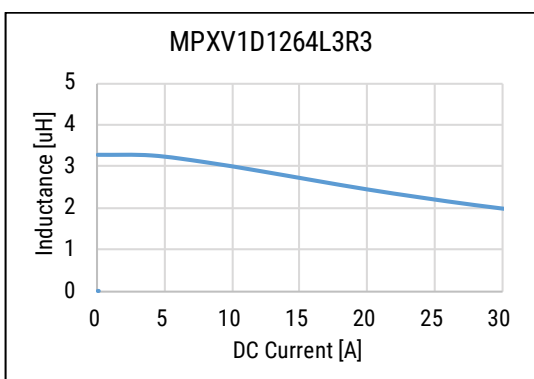
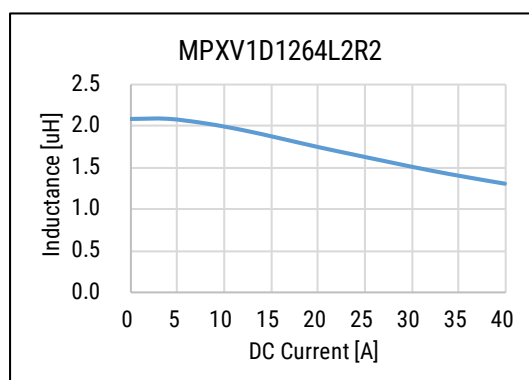
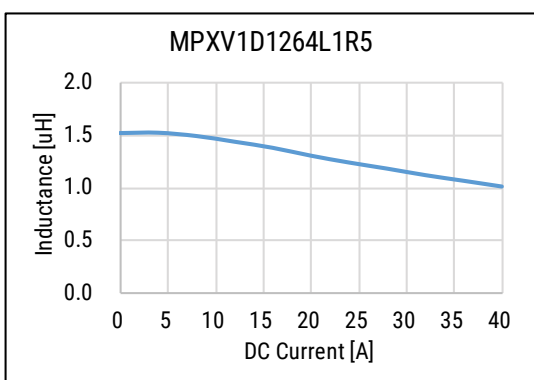
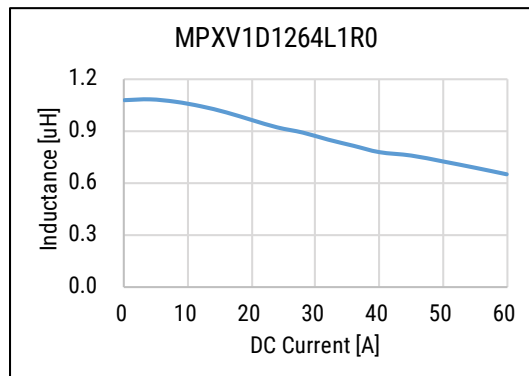
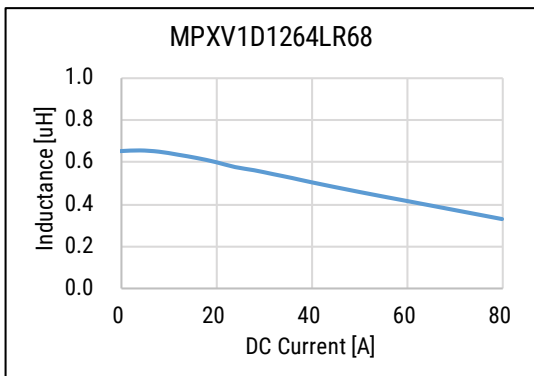

## DC-Superposed Characteristics cont.

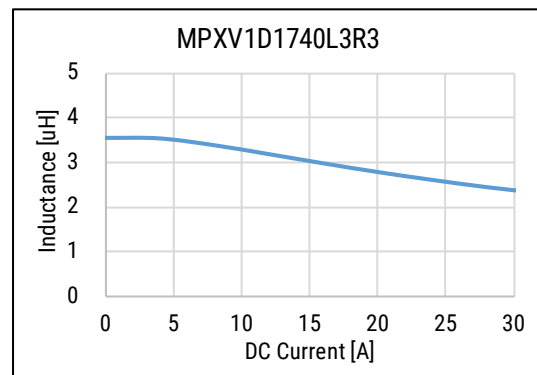
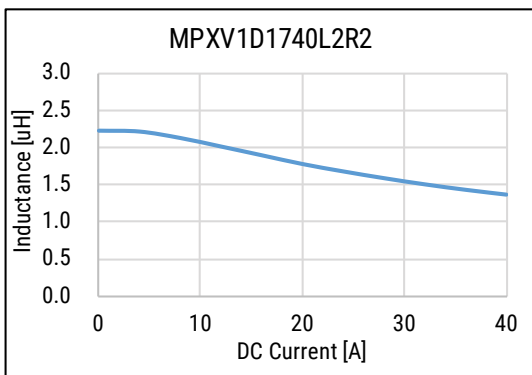
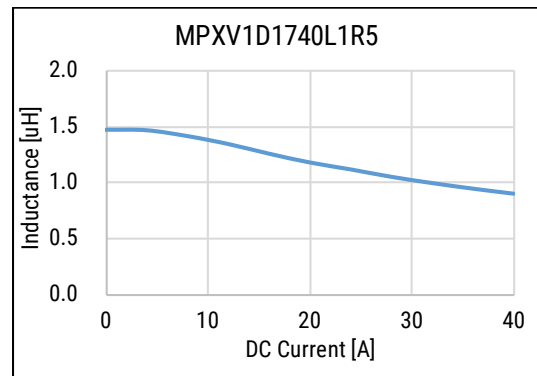
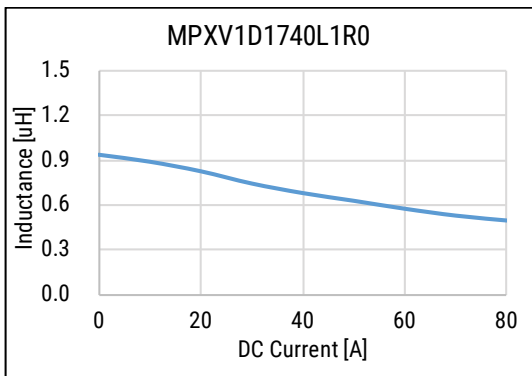
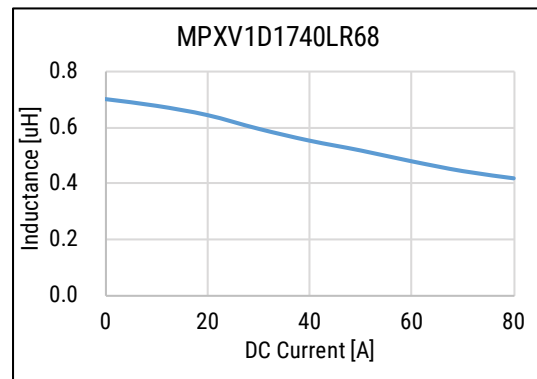
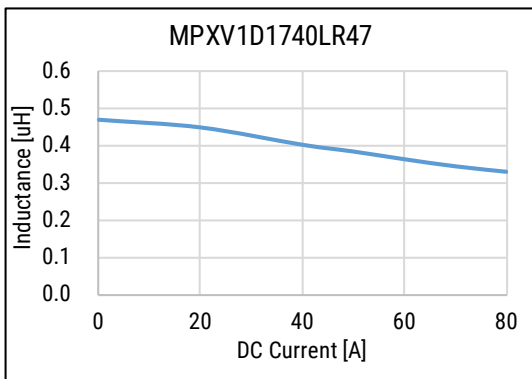
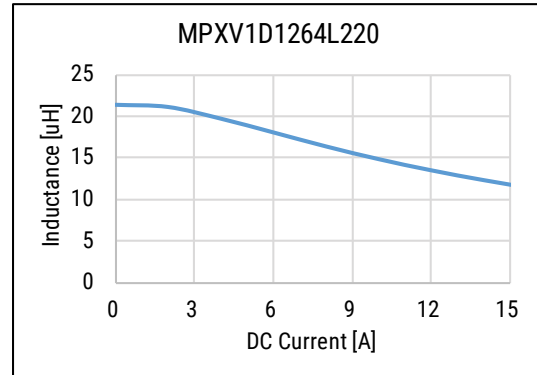
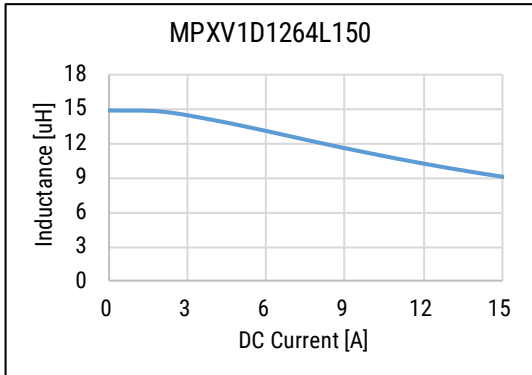

## DC-Superposed Characteristics cont.

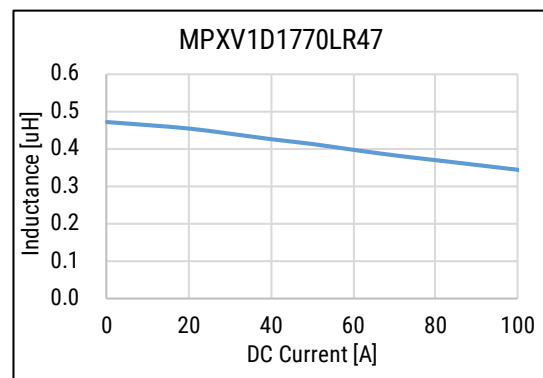
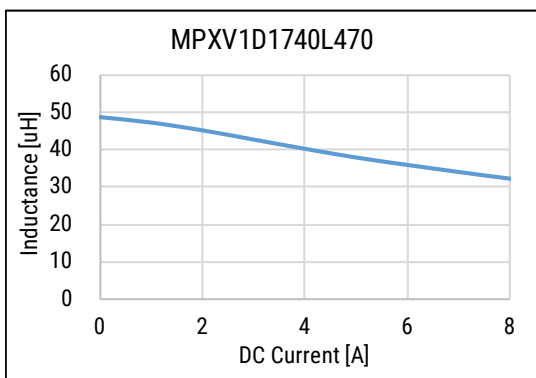
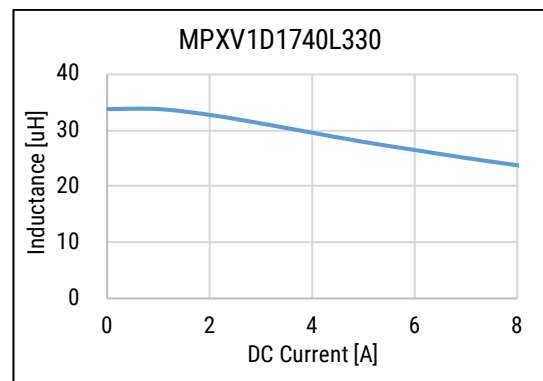
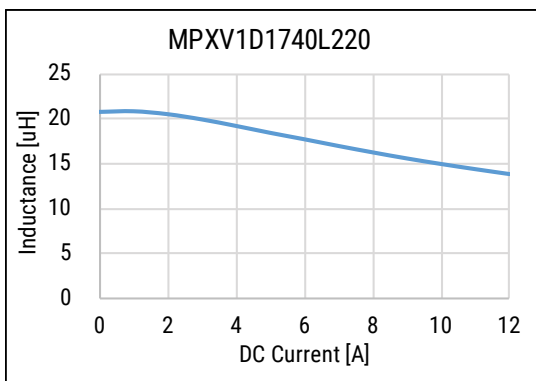
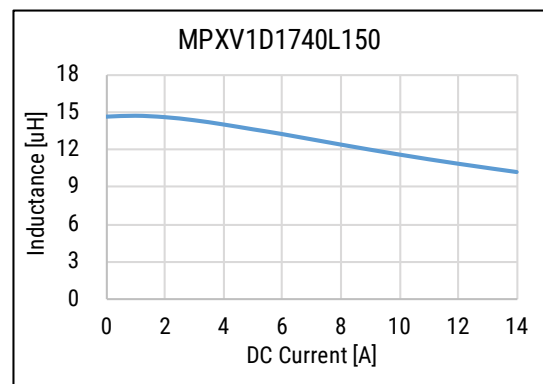
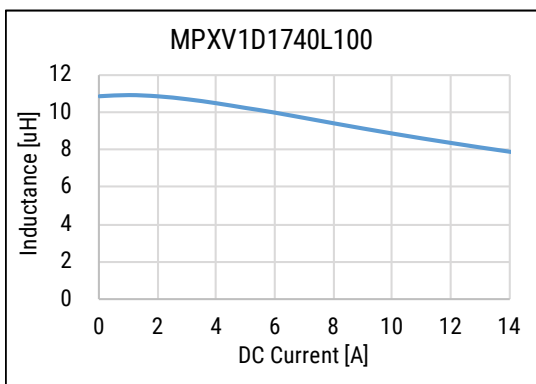
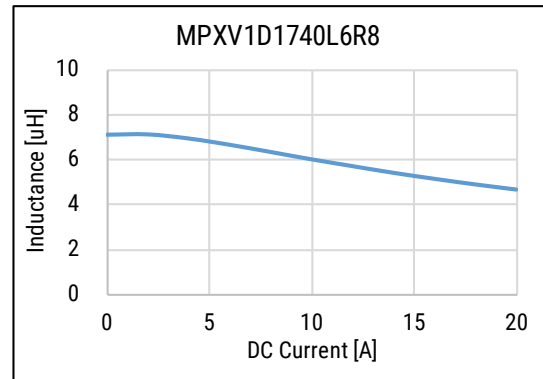
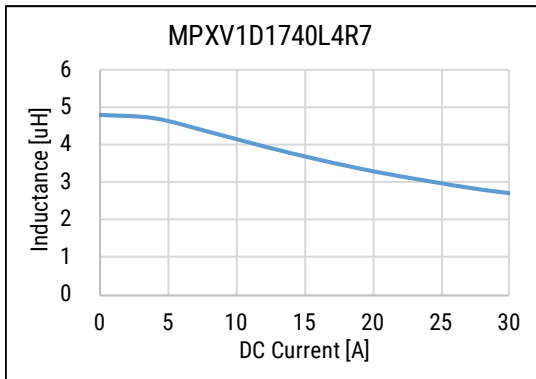

## DC-Superposed Characteristics cont.

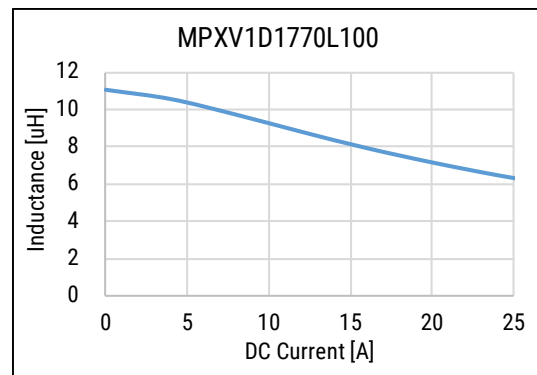
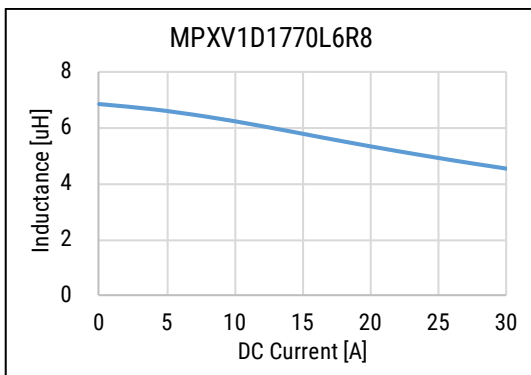
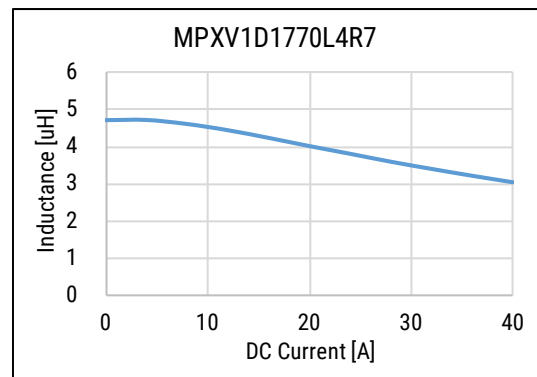
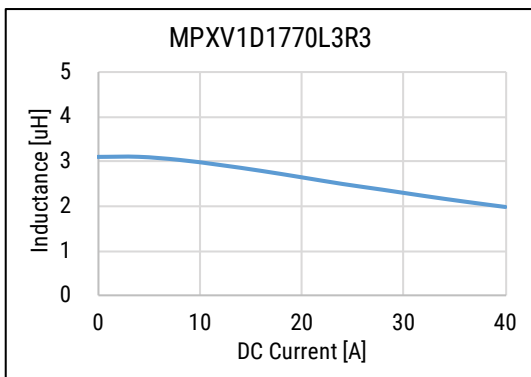
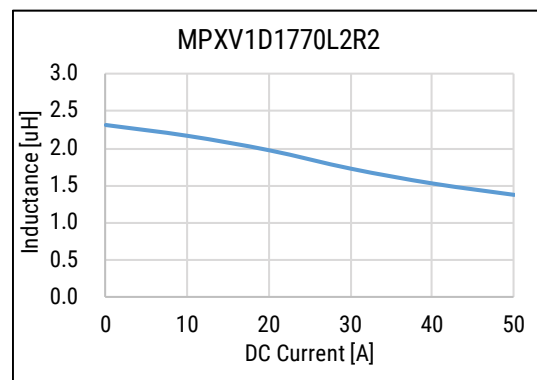
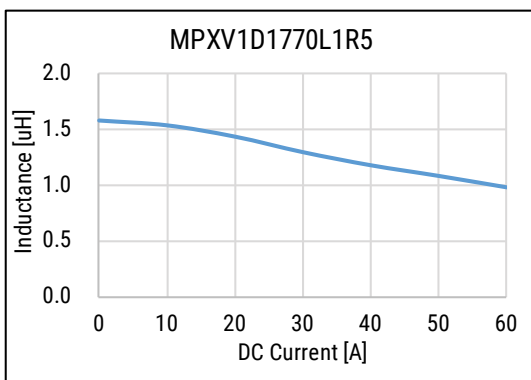
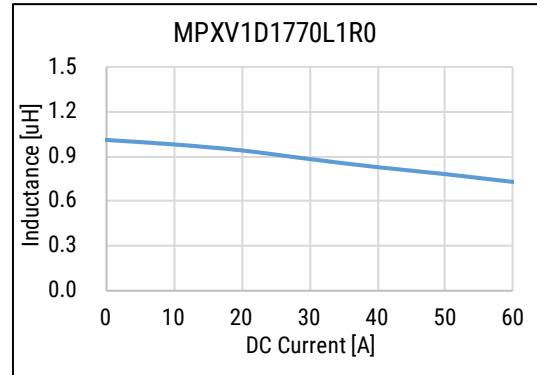
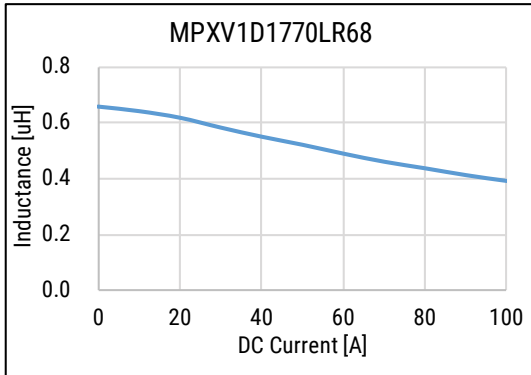

## DC-Superposed Characteristics cont.

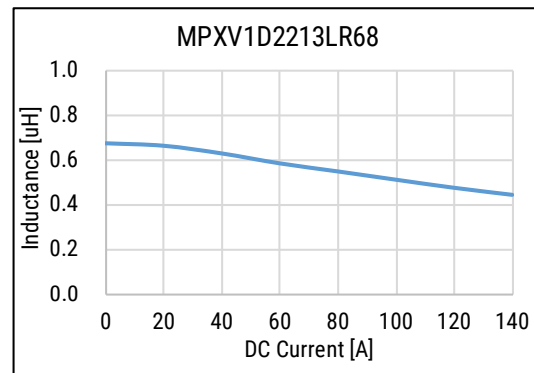
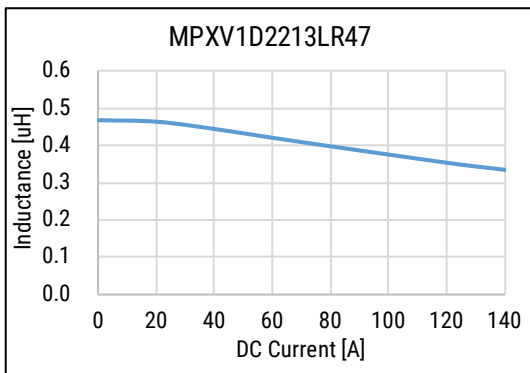
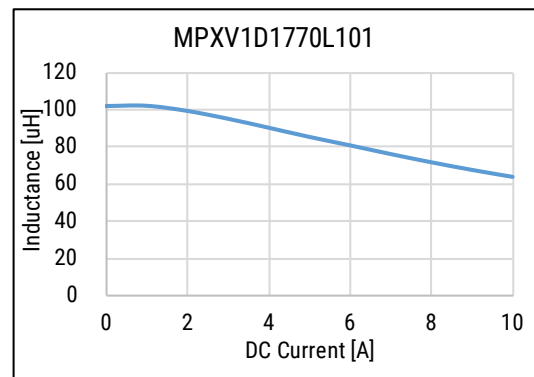
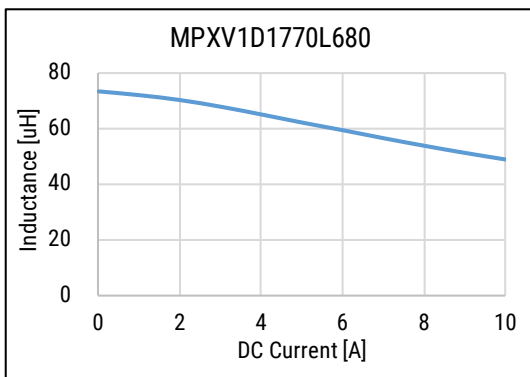
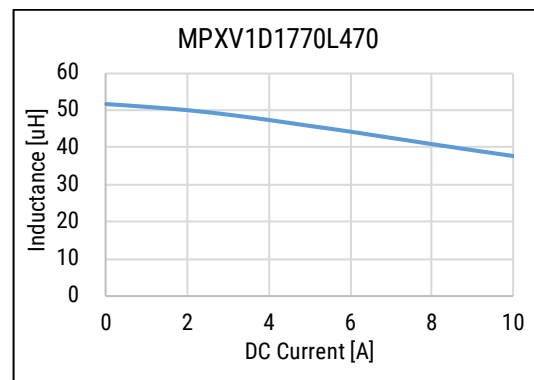
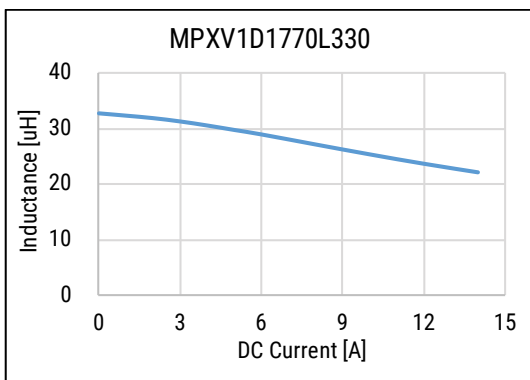
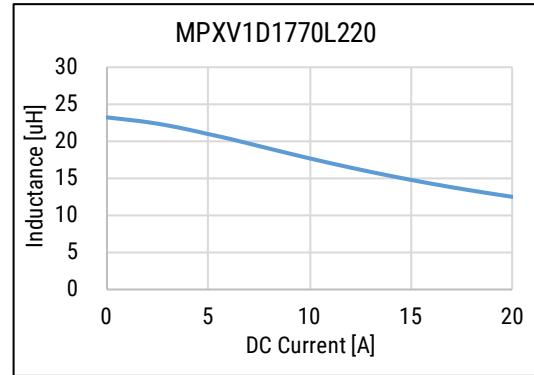
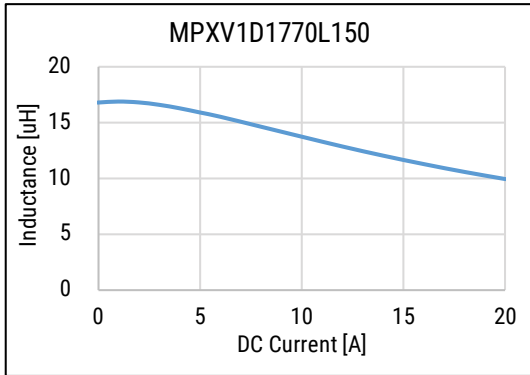



## DC-Superposed Characteristics cont.

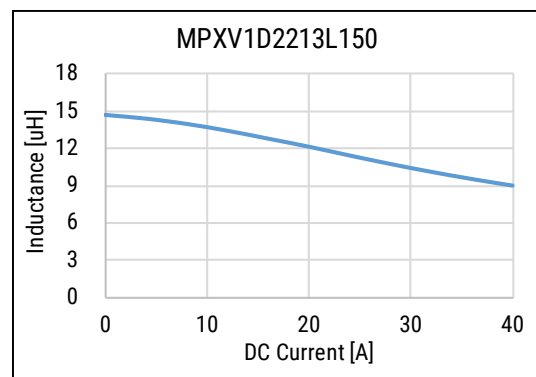
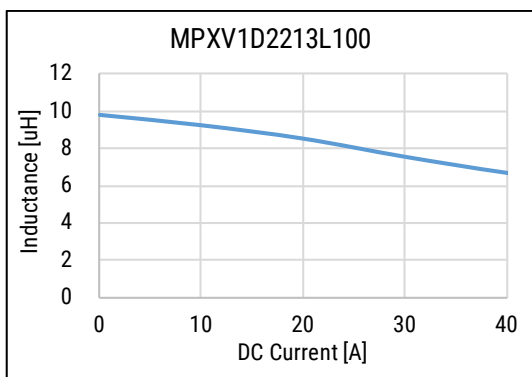
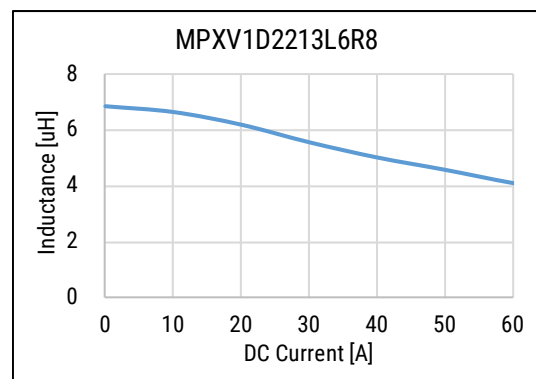
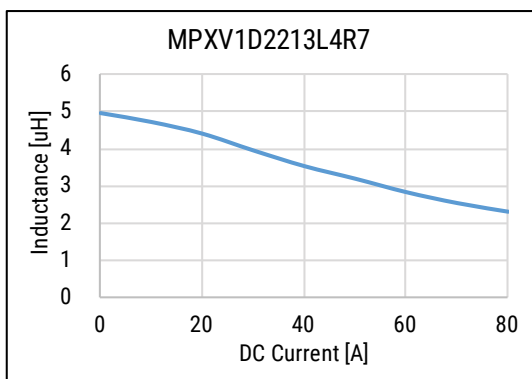
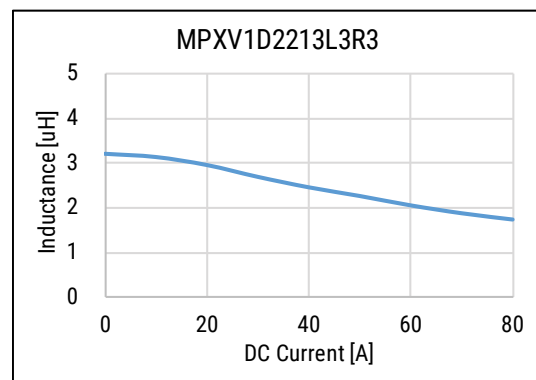
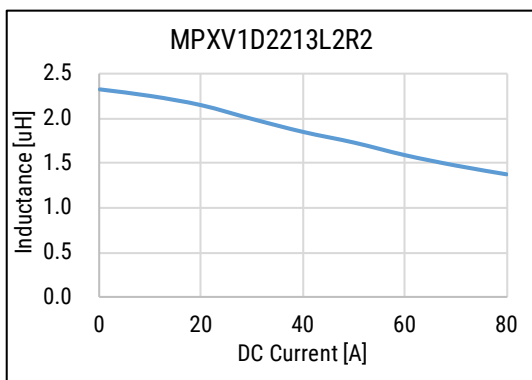
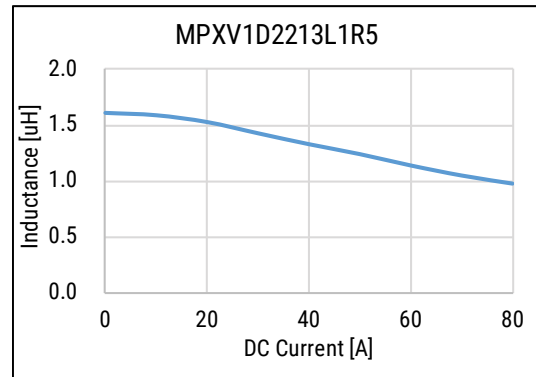
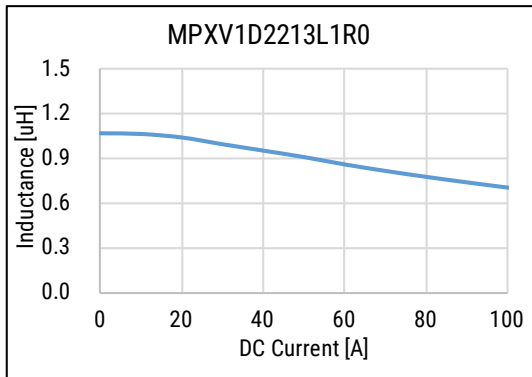

## DC-Superposed Characteristics cont.

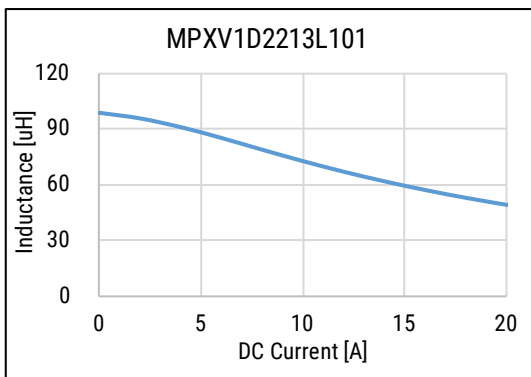
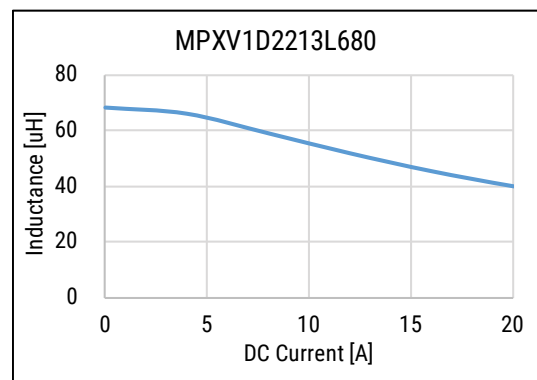
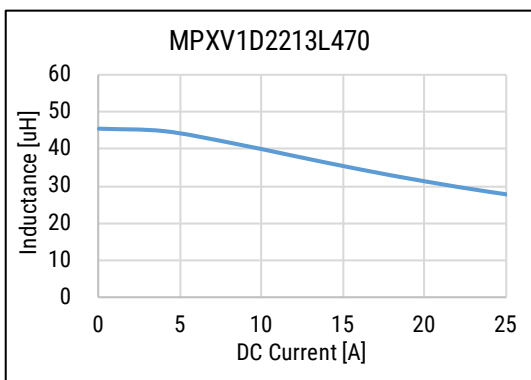
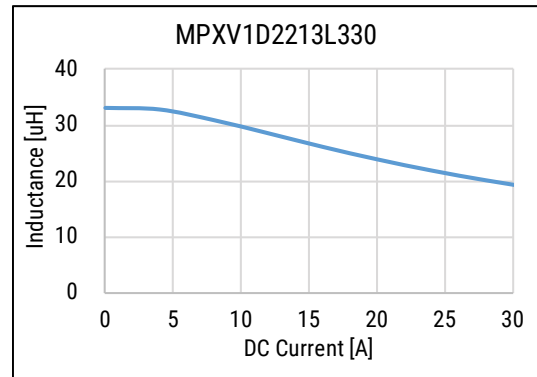
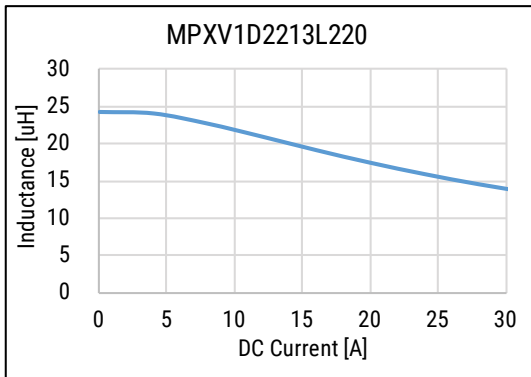

## Dimensions

Case Size	Dimensions (mm)	Land Pattern (mm)
MPXV1D0520		
MPXV1D0530		
MPXV1D0618		
MPXV1D0624		

## Dimensions cont.

Case Size	Dimensions (mm)	Land Pattern (mm)
MPXV1D0630	<p>7.0 ± 0.25              6.5 ± 0.2              3.0 Maximum              1.3              1.3</p>	<p>8.255              3.429              3.429</p>
MPXV1D0650	<p>7.0 ± 0.25              6.5 ± 0.2              5.0 Maximum              1.3              1.3</p>	<p>8.255              3.429              3.429</p>
MPXV1D0830	<p>8.65 ± 0.25              8.0 ± 0.2              3.0 Maximum              1.3              1.3</p>	<p>9.652              5.334              4.826</p>
MPXV1D0840	<p>8.65 ± 0.25              8.0 ± 0.2              4.0 Maximum              1.3              1.3</p>	<p>9.652              5.334              4.826</p>

**Dimensions cont.**

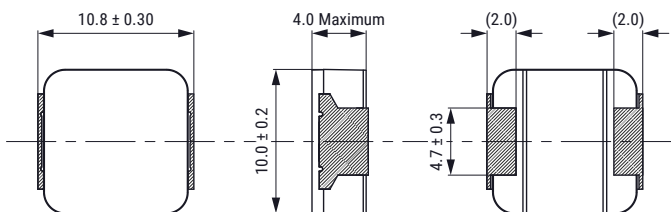
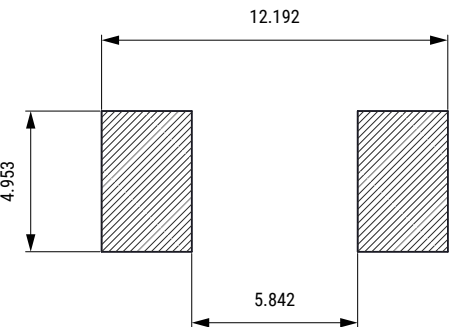
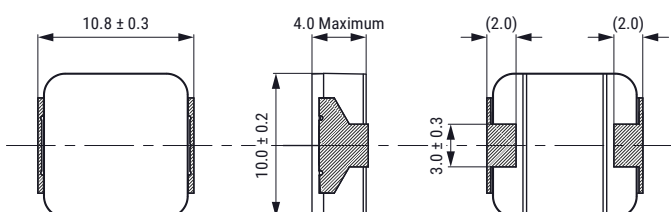
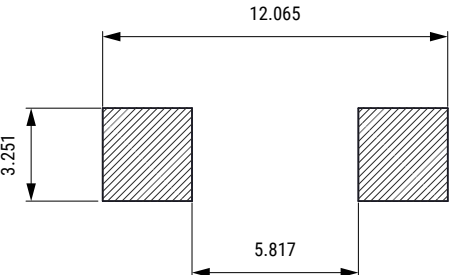
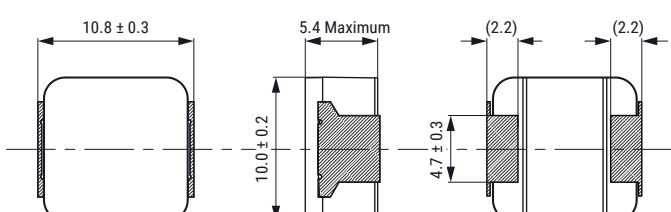
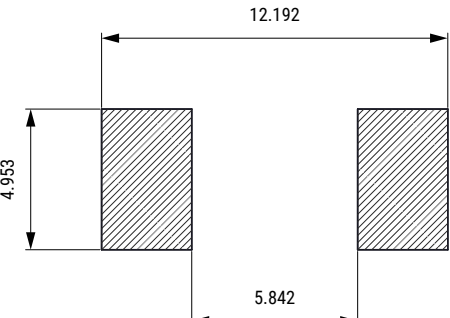
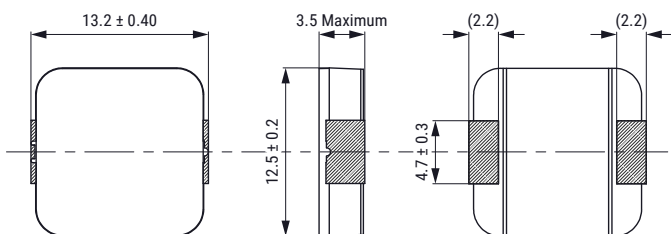
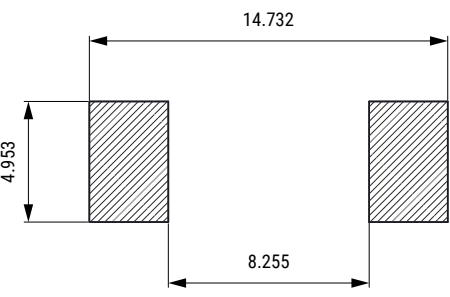
Case Size	Dimensions (mm)	Land Pattern (mm)
MPXV1D1040 For values up to 1.5 $\mu$ H or below		
MPXV1D1040 For values from 2.2 $\mu$ H or above		
MPXV1D1054		
MPXV1D1235 For values up to 0.47 $\mu$ H or below		

**Dimensions cont.**

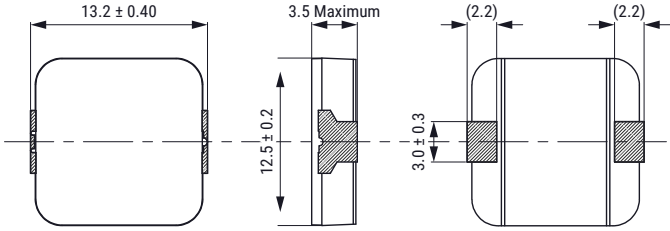
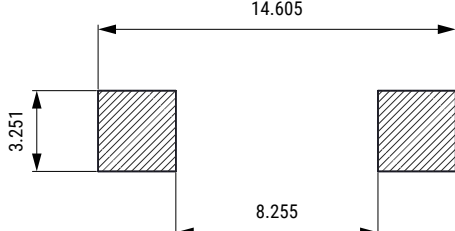
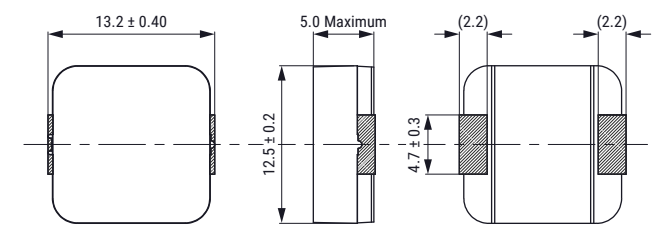
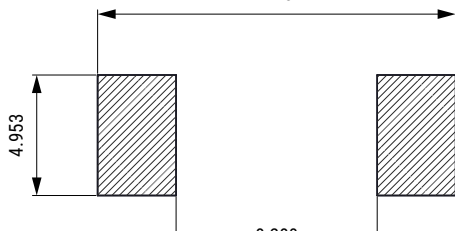
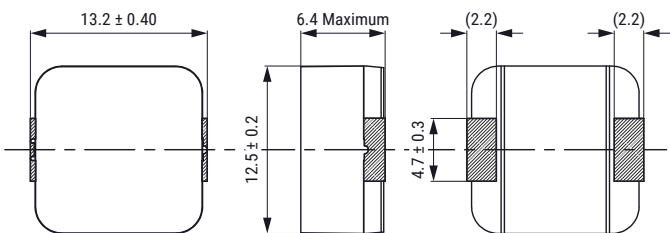
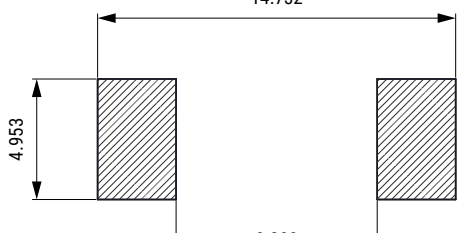
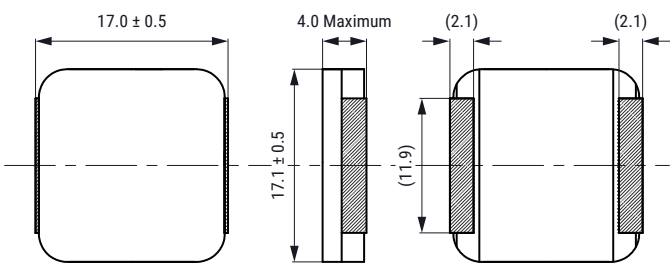
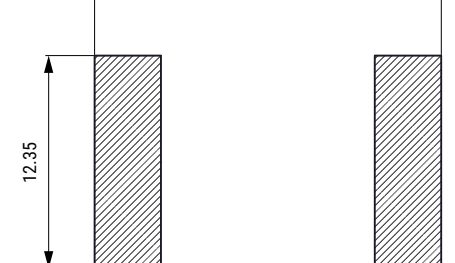
Case Size	Dimensions (mm)	Land Pattern (mm)
MPXV1D1235 For values from 0.68 $\mu$ H or above		
MPXV1D1250		
MPXV1D1264		
MPXV1D1740		

**Dimensions cont.**

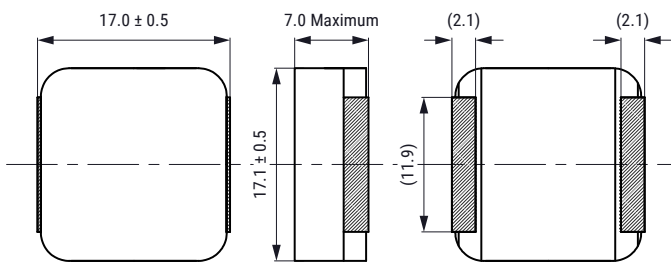
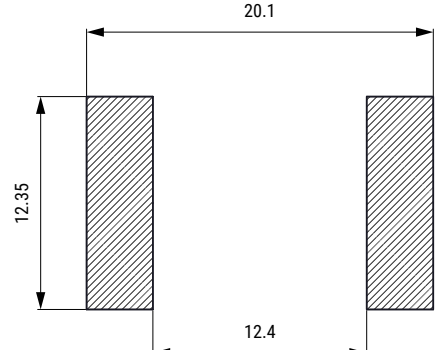
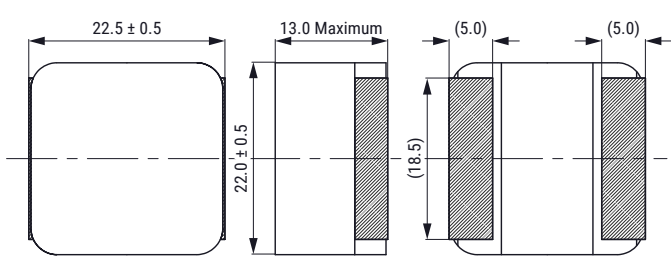
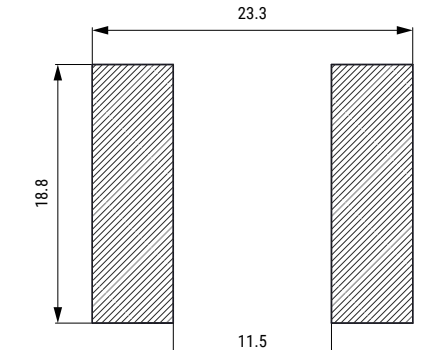
Case Size	Dimensions (mm)	Land Pattern (mm)
MPXV1D1770	 <p>Technical drawing of the MPXV1D1770 inductor. It includes three views: a top view showing a width of <math>17.0 \pm 0.5</math> mm; a side view showing a height of <math>17.1 \pm 0.5</math> mm and a maximum thickness of <math>7.0</math> mm; and an end view showing a diameter of <math>(11.9)</math> mm and two mounting tabs, each <math>(2.1)</math> mm wide.</p>	 <p>Land pattern diagram for the MPXV1D1770 inductor. It shows two rectangular pads. The total width between the inner edges of the pads is <math>20.1</math> mm. The height of each pad is <math>12.35</math> mm. The distance between the inner edges of the pads is <math>12.4</math> mm.</p>
MPXV1D2213	 <p>Technical drawing of the MPXV1D2213 inductor. It includes three views: a top view showing a width of <math>22.5 \pm 0.5</math> mm; a side view showing a height of <math>22.0 \pm 0.5</math> mm and a maximum thickness of <math>13.0</math> mm; and an end view showing a diameter of <math>(18.5)</math> mm and two mounting tabs, each <math>(5.0)</math> mm wide.</p>	 <p>Land pattern diagram for the MPXV1D2213 inductor. It shows two rectangular pads. The total width between the inner edges of the pads is <math>23.3</math> mm. The height of each pad is <math>18.8</math> mm. The distance between the inner edges of the pads is <math>11.5</math> mm.</p>

## Construction

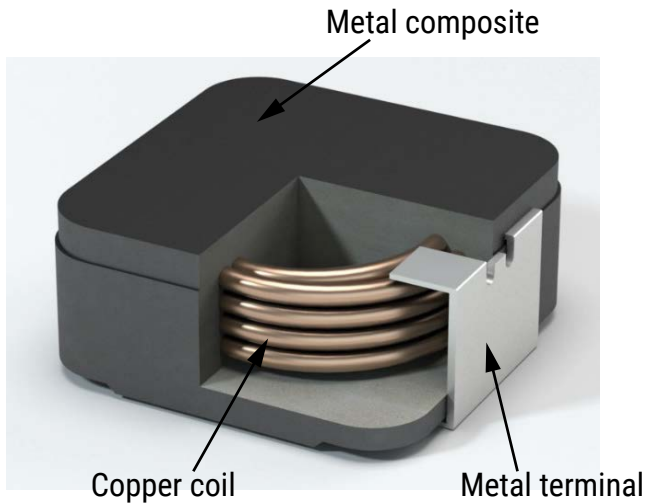

## Taping Specification

### Dimensions of Indented Square Hole Plastic Tape

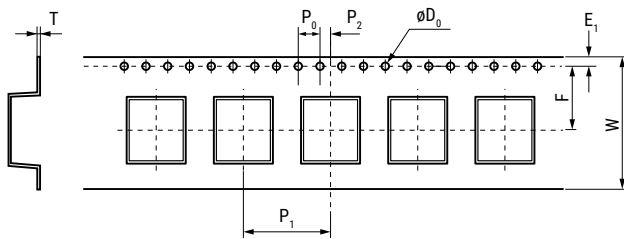

Case Size	Reel Quantity		Dimensions (mm)							
			W	F	E	P <sub>1</sub>	P <sub>2</sub>	P <sub>0</sub>	øD <sub>0</sub>	T
MPXV1D0520	3,500	Tolerance	±0.30	±0.10	±0.10	±0.10	±0.10	±0.10	±0.10	±0.05
		Nominal	12.00	5.50	1.75	8.00	2.00	4.00	1.50	0.40
MPXV1D0530	2,500	Tolerance	±0.30	±0.10	±0.10	±0.10	±0.10	±0.10	±0.10	±0.05
		Nominal	12.00	5.50	1.75	8.00	2.00	4.00	1.50	0.40
MPXV1D0618	2,500	Tolerance	±0.30	±0.10	±0.10	±0.10	±0.10	±0.10	±0.10	±0.05
		Nominal	16.00	7.50	1.75	12.00	2.00	4.00	1.50	0.40
MPXV1D0624	1,500	Tolerance	±0.30	±0.10	±0.10	±0.10	±0.10	±0.10	±0.10	±0.05
		Nominal	16.00	7.50	1.75	12.00	2.00	4.00	1.55	0.40
MPXV1D0630	1,500	Tolerance	±0.30	±0.10	±0.10	±0.10	±0.10	±0.10	±0.10	±0.05
		Nominal	16.00	7.50	1.75	12.00	2.00	4.00	1.55	0.40
MPXV1D0650	1,000	Tolerance	±0.30	±0.10	±0.10	±0.10	±0.10	±0.10	±0.05	±0.05
		Nominal	16.00	7.50	1.75	12.00	2.00	4.00	1.55	0.40
MPXV1D0830	1,500	Tolerance	±0.30	±0.10	±0.10	±0.10	±0.10	±0.10	±0.05	±0.05
		Nominal	16.00	7.50	1.75	12.00	2.00	4.00	1.55	0.40
MPXV1D0840	1,000	Tolerance	±0.30	±0.10	±0.10	±0.10	±0.10	±0.10	±0.05	±0.05
		Nominal	16.00	7.50	1.75	12.00	2.00	4.00	1.50	0.40



## Taping Specification cont.

### Dimensions of Indented Square Hole Plastic Tape

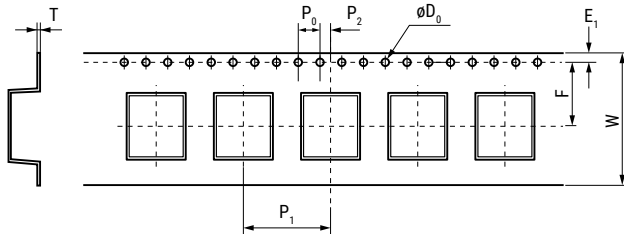

Case Size	Reel Quantity		Dimensions (mm)								
			W	F	E	P <sub>1</sub>	P <sub>2</sub>	P <sub>0</sub>	øD <sub>0</sub>	T	
MPXV1D1040	500	Tolerance	±0.3	±0.1	±0.1	±0.1	±0.1	±0.1	±0.1	±0.05	±0.05
		Nominal	24.0	11.5	1.75	16.0	2.0	4.0	1.55	0.4	
MPXV1D1054	500	Tolerance	±0.3	±0.1	±0.1	±0.1	±0.1	±0.1	±0.1	±0.05	±0.05
		Nominal	24.0	11.5	1.75	16.0	2.0	4.0	1.55	0.4	
MPXV1D1235	500	Tolerance	±0.3	±0.1	±0.1	±0.1	±0.1	±0.1	±0.1	±0.05	±0.05
		Nominal	24.0	11.5	1.75	24.0	2.0	4.0	1.55	0.4	
MPXV1D1250	250	Tolerance	±0.3	±0.1	±0.1	±0.1	±0.1	±0.1	±0.1	±0.05	±0.05
		Nominal	24.0	11.5	1.75	24.0	2.0	4.0	1.55	0.4	
MPXV1D1264	250	Tolerance	±0.3	±0.1	±0.1	±0.1	±0.1	±0.1	±0.1	±0.05	±0.05
		Nominal	24.0	11.5	1.75	24.0	2.0	4.0	1.55	0.4	
MPXV1D1740	100	Tolerance	±0.3	±0.1	±0.1	±0.1	±0.1	±0.1	±0.1	±0.1	±0.05
		Nominal	32.0	14.2	1.75	24.0	2.0	4.0	1.50	0.5	
MPXV1D1770	100	Tolerance	±0.3	±0.1	±0.1	±0.1	±0.1	±0.1	±0.1	±0.1	±0.05
		Nominal	32.0	14.2	1.75	24.0	2.0	4.0	1.50	0.5	
MPXV1D2213	50	Tolerance	±0.3	±0.1	±0.1	±0.1	±0.1	±0.1	±0.1	±0.1	±0.05
		Nominal	44.0	20.2	1.75	32.0	2.0	4.0	1.50	0.5	

## Reel Specifications

### Reel Dimensions

MPXV1D05XX

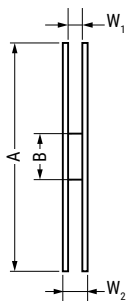
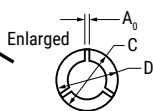
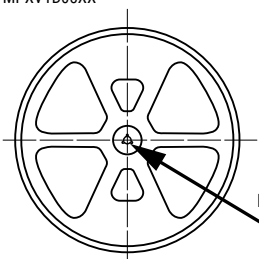

MPXV1D06XX, MPXV1D08XX, MPXV1D10XX,  
MPXV1D12XX, MPXV1D17XX, MPXV1D22XX

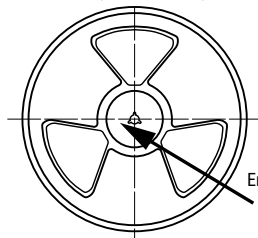

Case Size		Dimensions (mm)						
		A	B	C	D	A <sub>0</sub>	W <sub>1</sub>	W <sub>2</sub>
MPXV1D0520	Tolerance	±2.0	±2.0	±0.2	±0.8	±0.5		
	Nominal	ø330	ø80	ø13.0	ø21.0	2.0	13.5	17.5
MPXV1D0530	Tolerance	±2.0	±2.0	±0.2	±0.8	±0.5		
	Nominal	ø330	ø80	ø13.0	ø21.0	2.0	13.5	17.5
MPXV1D0618	Tolerance	±2.0	±2.0	±0.2	±0.8	±0.5		
	Nominal	ø330	ø100	ø13.2	ø21.5	2.5	16.9	21.3
MPXV1D0624	Tolerance	±2.0	±2.0	±0.2	±0.8	±0.5		
	Nominal	ø330	ø100	ø13.2	ø21.5	2.5	16.9	21.3
MPXV1D0630	Tolerance	±2.0	±2.0	±0.2	±0.8	±0.5		
	Nominal	ø330	ø100	ø13.2	ø21.5	2.5	16.9	21.3
MPXV1D0650	Tolerance	±2.0	±2.0	±0.2	±0.8	±0.5		
	Nominal	ø330	ø100	ø13.2	ø21.5	2.5	16.9	21.3
MPXV1D0830	Tolerance	±2.0	±2.0	±0.2	±0.8	±0.5		
	Nominal	ø330	ø100	ø13.2	ø21.5	2.5	16.9	21.3
MPXV1D0840	Tolerance	±2.0	±2.0	±0.2	±0.8	±0.5		
	Nominal	ø330	ø100	ø13.2	ø21.5	2.5	16.9	21.3
MPXV1D1040	Tolerance	±3.0	±2.0	±0.5	±0.8	±0.5		
	Nominal	ø330	ø100	ø13.0	ø21.5	2.6	17.0	20.6
MPXV1D1054	Tolerance	±3.0	±2.0	±0.5	±0.8	±0.5		
	Nominal	ø330	ø100	ø13.0	ø21.5	2.6	17.0	20.6
MPXV1D1235	Tolerance	±3.0	±2.0	±0.5	±0.8	±0.5		
	Nominal	ø330	ø100	ø13.0	ø21.5	2.6	17.0	20.6
MPXV1D1250	Tolerance	±3.0	±2.0	±0.5	±0.8	±0.5		
	Nominal	ø330	ø100	ø13.0	ø21.5	2.6	17.0	20.6
MPXV1D1264	Tolerance	±3.0	±2.0	±0.5	±0.8	±0.5		
	Nominal	ø330	ø100	ø13.0	ø21.5	2.6	17.0	20.6
MPXV1D1740	Tolerance	±3.0	±2.0	±0.2	±0.8	±0.5		
	Nominal	ø330	ø100	ø13.0	ø21.0	2.0	32.4	38.4
MPXV1D1770	Tolerance	±3.0	±2.0	±0.2	±0.8	±0.5		
	Nominal	ø330	ø100	ø13.0	ø21.0	2.0	32.4	38.4
MPXV1D2213	Tolerance	±3.0	±2.0	±0.2	±0.8	±0.5		
	Nominal	ø330	ø100	ø13.0	ø21.0	2.0	44.4	50.4

## Soldering Process

### Recommended Reflow Soldering Profile

Reference ICP/JEDEC J-STD-020E

Profile Feature	Pb-Free Assembly
<b>Preheat/Soak</b>	
Temperature Minimum ( $T_{smin}$ )	150°C
Temperature Maximum ( $T_{smax}$ )	200°C
Time ( $t_s$ ) from $T_{smin}$ to $T_{smax}$	60 – 120 seconds
Ramp-Up Rate ( $T_L$ to $T_p$ )	3°C/second maximum
Liquidous Temperature ( $T_L$ )	217°C
Time Above Liquidous ( $t_L$ )	60 – 150 seconds
Peak Temperature ( $T_p$ )	260°C for MPXV1D0520, 0618, 0624 250°C for MPXV1D0530, 0630, 0650, 0830, 0840 245°C for MPXV1D1040, 1054, 1235, 1250, 1264, 1740, 1770, 2213
Time within 5°C of Maximum Peak Temperature ( $t_p$ )	30 seconds maximum
Ramp-Down Rate ( $T_p$ to $T_L$ )	6°C/second maximum
Time 25°C to Peak Temperature	8 minutes maximum

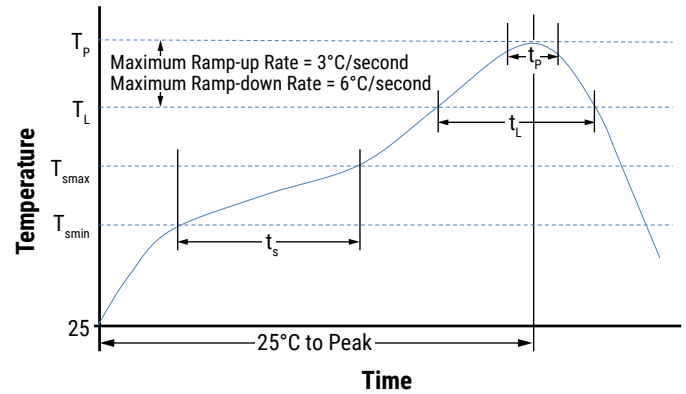

## Handling Precautions

Inductors should be stored in normal working environments. While the inductors themselves are quite robust in other environments, exposure to high temperatures, high humidity, corrosive atmospheres, and long-term storage degrades solderability.

KEMET recommends that maximum storage temperature not exceed 40°C and maximum storage humidity not exceed 70% relative humidity. Atmospheres should be free of chlorine-bearing and sulfur-bearing compounds. Temperature fluctuations should be minimized to avoid condensation on the parts.

For optimized solderability, inductor stock should be used promptly, preferably within six months of receipt.

## KEMET Electronics Corporation Sales Offices

For a complete list of our global sales offices, please visit [www.kemet.com/sales](http://www.kemet.com/sales).

---

### Disclaimer

All product specifications, statements, information and data (collectively, the "Information") in this datasheet are subject to change. The customer is responsible for checking and verifying the extent to which the Information contained in this publication is applicable to an order at the time the order is placed. All Information given herein is believed to be accurate and reliable, but it is presented without guarantee, warranty, or responsibility of any kind, expressed or implied.

Statements of suitability for certain applications are based on KEMET Electronics Corporation's ("KEMET") knowledge of typical operating conditions for such applications, but are not intended to constitute – and KEMET specifically disclaims – any warranty concerning suitability for a specific customer application or use. The Information is intended for use only by customers who have the requisite experience and capability to determine the correct products for their application. Any technical advice inferred from this Information or otherwise provided by KEMET with reference to the use of KEMET's products is given gratis, and KEMET assumes no obligation or liability for the advice given or results obtained.

Although KEMET designs and manufactures its products to the most stringent quality and safety standards, given the current state of the art, isolated component failures may still occur. Accordingly, customer applications which require a high degree of reliability or safety should employ suitable designs or other safeguards (such as installation of protective circuitry or redundancies) in order to ensure that the failure of an electrical component does not result in a risk of personal injury or property damage.

Although all product-related warnings, cautions and notes must be observed, the customer should not assume that all safety measures are indicated or that other measures may not be required.

When providing KEMET products and technologies contained herein to other countries, the customer must abide by the procedures and provisions stipulated in all applicable export laws and regulations, including without limitation the International Traffic in Arms Regulations (ITAR), the US Export Administration Regulations (EAR) and the Japan Foreign Exchange and Foreign Trade Act.

*KEMET is a registered trademark of KEMET Electronics Corporation.*