

VITA 67

**OPEN VPX RF PRODUCT PORTFOLIO
ENABLING AN OPEN VPX WORLD!**



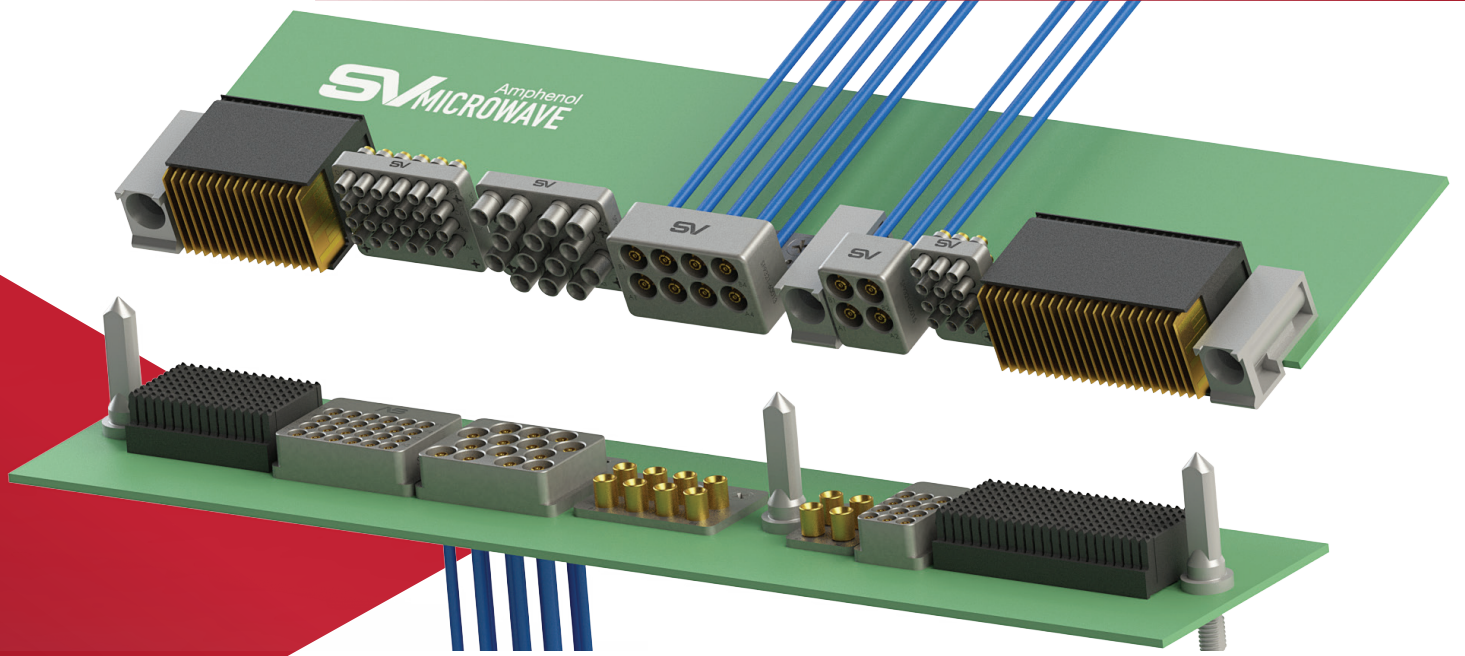

Photo courtesy of Annapolis Micro Systems

OPEN VPX RF PRODUCT PORTFOLIO

SV Microwave has developed an extensive portfolio of VITA 67 RF products. These RF connectors and cables deliver high performance and rugged durability to chassis and payload cards while meeting the industry standards for interoperability. We have complimented our product portfolio with adapters and accessories to provide point-to-point connectivity for all your RF requirements.

TABLE OF CONTENTS:

3	VITA 67.3 Overview
4	VITA 67.3 SMPM Series
4	SMPM Backplane Connector Modules
5	SMPM Backplane Contacts
6	SMPM Plug-In Connector Modules
7	SMPM Electrical Test Data
8	VITA 67.3 SMPS Series
8	SMPS Backplane Connector Modules
9	SMPS Backplane Contacts
10	SMPS Plug-In Connector Modules
11	SMPS Electrical Test Data
12	VITA 67.1 and 67.2 Overview
13	VITA 67.X Cable Assemblies



Rev. 1 (10/19)

VITA 67.3 OVERVIEW

The VITA 67.3 specification draws on the solutions provided in 67.1 and 67.2 but is unique as it doesn't define the locations of the ports like its predecessors. Additionally, floating contacts have been moved to the backplane side (vs the Plug-In side in 67.1 and 67.2). These two changes were implemented to allow Plug-In Module designers the freedom to implement direct RF connector PCB launches on the carrier and/or any mezzanine card, eliminating the requirement for RF cable assemblies on the Plug-In Module. However cable options are available and still permitted.

Chassis and card-manufactures work toward developing an interoperable solution satisfying their immediate density and performance related challenges. In order to assure the most robust solutions, it is advisable to use modules and contacts from same manufacturers. However, fully populated Plug-In Modules utilizing V67.3 hardware from two different OEMs qualified to the VPX standard can plug-in to the same backplane slot.

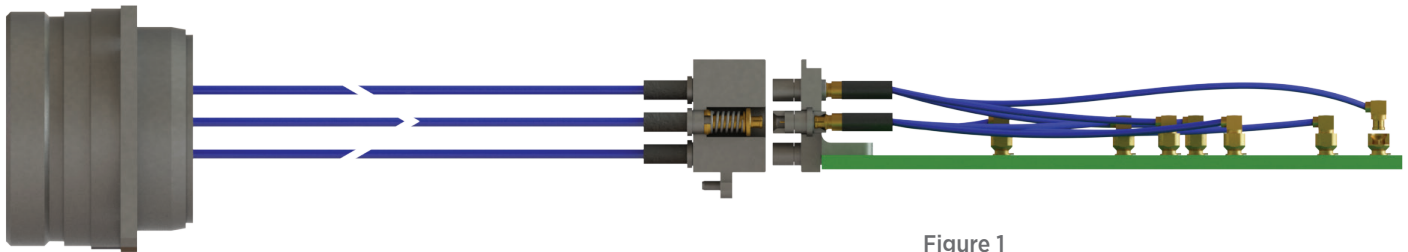

Figure 1
VITA 67.3 Configuration Example with
D38999 I/O connector on Backplane Side

VITA 67.3 Connector Modules C, D and E were developed to take advantage of the 1" pitch between adjacent Plug-In Modules. SV Microwave has created variety of backplane connector modules fitting the Module C envelope. While we can customize these to accommodate any application, the most widely adopted options have been the 10 and 14 port configurations that are now available in our global distribution channel.



Figure 1.1
Module D (1/2 Width)

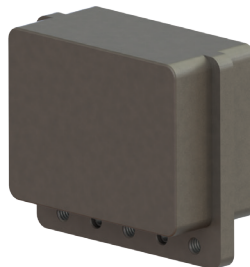

Figure 1.2
Module C (Full Width)



Figure 1.3
Module E (1 1/2 Width)

VITA 67.3 SMPM SERIES

SV Microwave's VITA 67.3 SMPM series electrical and mechanical performance meet and exceed the standards specified in ANSI/VITA67.3-2017, listed below for reference.

SPECIFICATIONS – VITA 67.3 SMPM (MATED PAIR)				
ELECTRICAL			MECHANICAL	
VSWR	2 MHz to 40 GHz	1.5:1 Max	Axial Travel	.079"
Insertion Loss	2 MHz to 40 GHz	.12 * $\sqrt{(f(\text{GHz}))}$	Radial Float	± .010"
Cross Talk Requirement (dB MIN)	3 MHz to 30 MHz	≥ 140 dB	Engage Force	3.5 lbs (typ)
	30 MHz to 3 GHz	≥ 120 dB	Disengage Force	3.5 lbs (typ)
	3 GHz to 27 GHz	≥ 100 dB	Min Pitch (.047")	.228"
	27 GHz to 40 GHz	≥ 90 dB	Min Pitch (.086")	.228"
Power Handling	3 MHz to 30 MHz	30 dBm	Spring Force (Full Deflection)	4.25 lbs (typ)
	30 MHz to 3 GHz	20 dBm	Mating Cycles	500 Min
	3 GHz to 40 GHz	20 dBm	Vibration	MIL-STD-810

VITA 67.3 SMPM BACKPLANE CONNECTOR MODULES



VITA 67.3 SMPM
10-Port Backplane
Connector Module
SV PN: SF9321-60059



VITA 67.3 SMPM
14-Port Backplane
Connector Module
SV PN: SF9321-60086

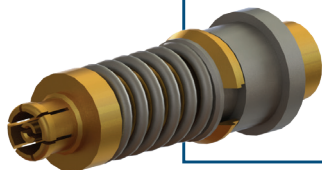

VITA 67.3 SMPM
Backplane Contact
For .086" Cable
SV PN: 3221-40066

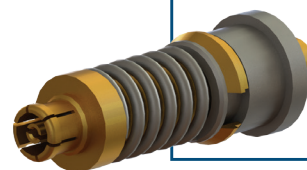

VITA 67.3 SMPM
Backplane Contact
For .047" Cable
SV PN: 3221-40071

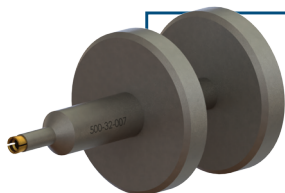

VITA 67.3 SMPM
Adapter Insertion/
Removal Tool
SV PN: 500-32-007

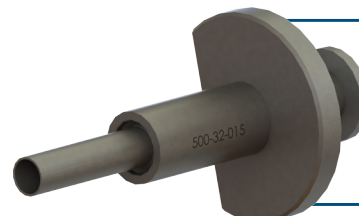

VITA 67.3 SMPM
Contact Removal Tool
SV PN: 500-32-015

INSTALLATION INSTRUCTIONS – VITA 67.3 SMPM BACKPLANE CONNECTOR CONTACTS

VITA 67.3 SMPM contacts have a unique ‘contact + adapter’ configuration that enables them to be easily assembled and removed from the Backplane Connector Module and provide excellent radial captivation on the multiport block.

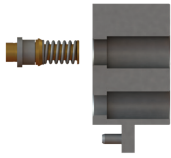

Figure 2
Contact Installation to Connector Module (by hand)

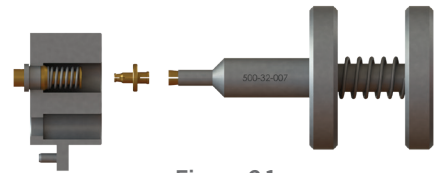

Figure 2.1
Adapter Installation to Contact Uses Tool PN 500-32-007

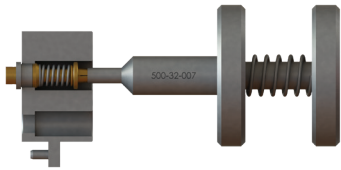

Figure 2.2
Adapter Fully Seated in Contact

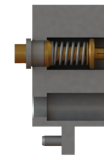

Figure 2.3
Final Assembly Connector Module + Contact + Adapter

REMOVAL INSTRUCTIONS – VITA 67.3 SMPM BACKPLANE CONNECTOR CONTACTS

To remove the contacts (once adapters are extracted), removal tool PN 500-32-015 is used to compress the clip and plunge the contact from the housing. SV Microwave has

also developed an extended length removal tool (not shown, PN 500-32-042) for deep chassis applications.

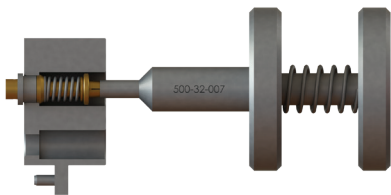

Figure 2.4
Adapter Removed From Contact Uses Tool PN 500-32-007

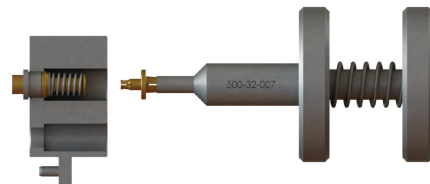

Figure 2.5
Adapter Removed From Contact

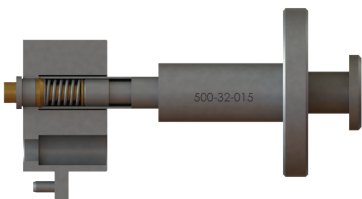

Figure 2.6
Contact Removed Uses Tool PN 500-32-015



Figure 2.7
Contact Removed from Block

VITA 67.3 SMPM PLUG-IN CONNECTOR MODULES

Plug-In Connector Modules are manufactured by a variety of embedded systems technology companies with the common goal of interfacing to the backplane.



VITA 67.3 SMPM
10-Port Plug-In
Connector Module
SV PN: SF9311-60097

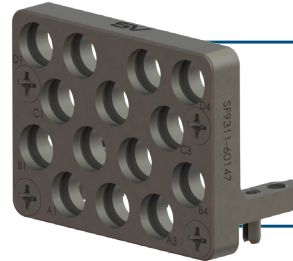

VITA 67.3 SMPM
14-Port Plug-In
Connector Module
SV PN: SF9311-60147

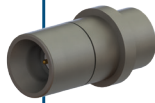

VITA 67.3 SMPM
Plug-In Adapter
SV PN: SF1132-6067

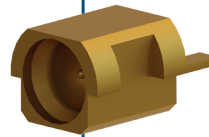

SMPM Male Edge Launch
Connector
(Smooth Bore)
SV PN: 3211-60035

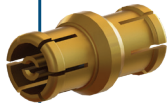

SMPM Female-Female
Adapter (.211")
SV PN: 3290-4002

A new feature of the VITA 67.3 design is the ability to launch directly from a Plug-In Connector Module to a PCB. This concept is shown below along with an example of a Plug-In Connector Module using both cables and PCB launch connectors.

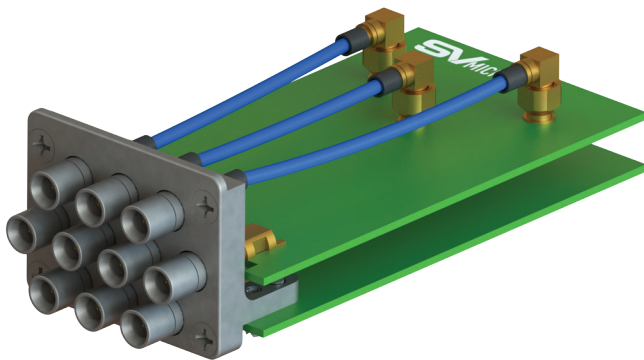

Figure 3
Stacked Card Plug-In Connector Module
Example - RF to Edge Launch and Cable

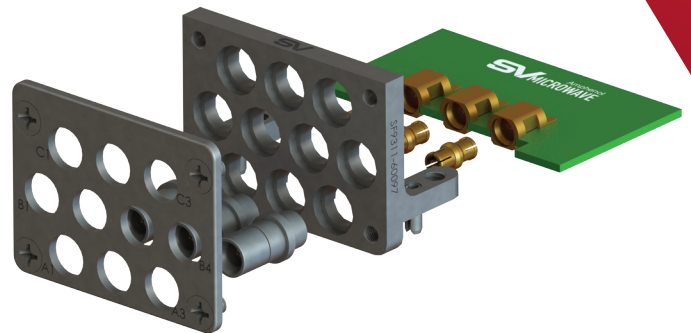

Figure 3.1
Exploded View
Plug-In Connector Module to PCB

VITA 67.3 SMPM ELECTRICAL TEST DATA

Mated pair testing of Backplane and Plug-In Connector Modules confirms specification data. Positioning of gate flags is important since the specification references mated pair performance, as SV can provide a full signal path solution that includes almost any standard RF interface.

The aluminum block shown in Figure 4 holds the male and female contacts in the proper alignment position during testing, replicating the geometry of the end application.

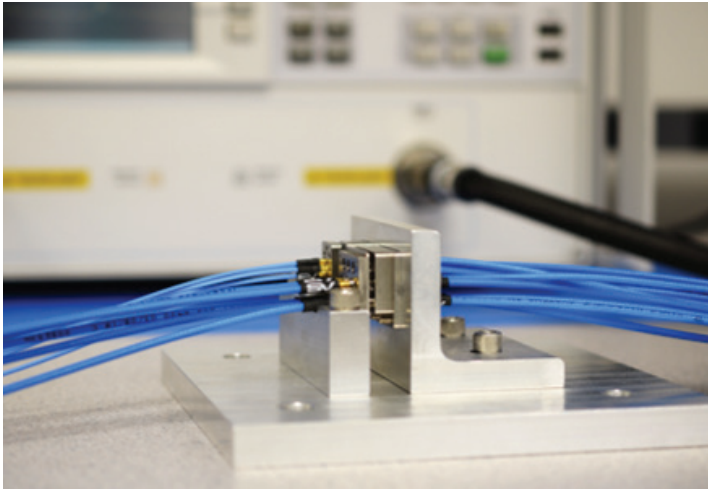

Figure 4
Test Setup for Mated Pair
VITA 67.3 SMPM

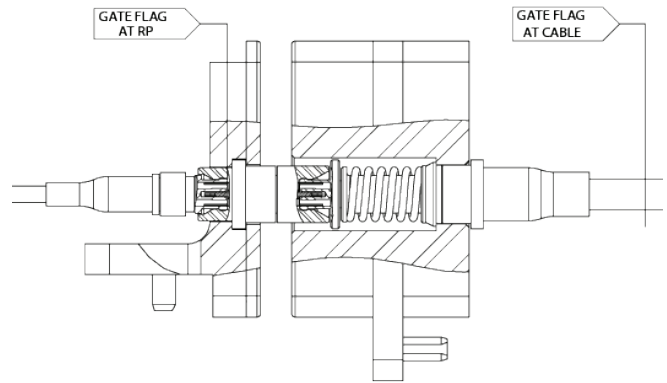

Figure 4.1
Gate flag position for SMPM Mated
Pair Measurement

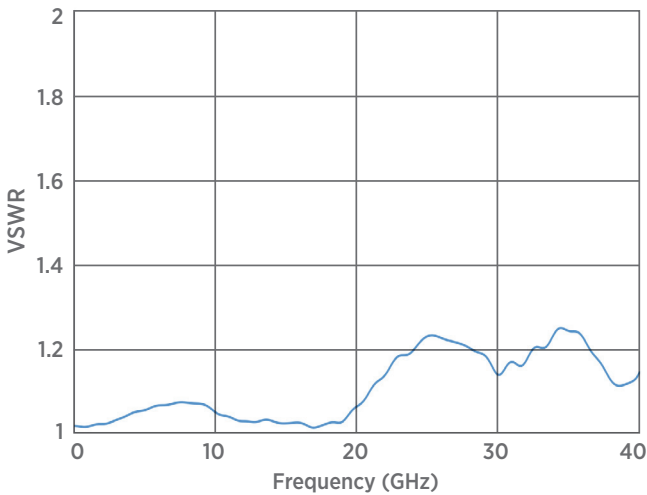

Figure 4.2
Gated VSWR Plot (typical)

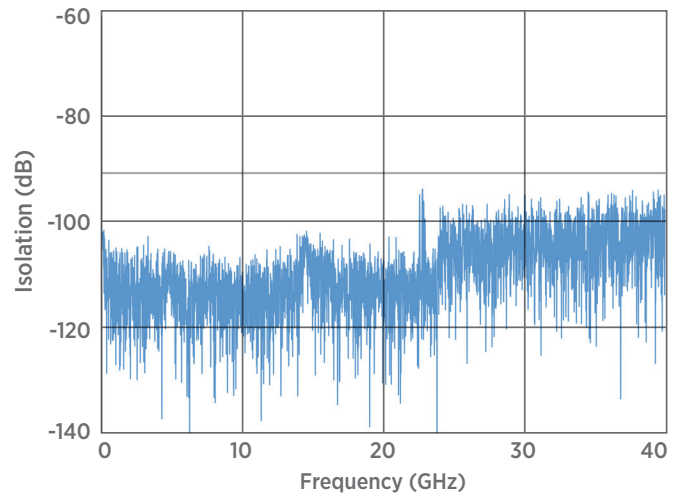

Figure 4.3
Electrical Isolation Plot
(Mated Pair)

VITA 67.3 SMPS SERIES

In order to support design flexibility, increased data rates and high density requirements of VPX platforms SV Microwave has designed VITA 67.3 modules with our smallest high performance interface - the SMPS Series. SMPS has been an

industry standard for over 10 years and is used extensively on some of the most demanding US MIL-AERO programs. The SMPS interface is currently being adopted as a DLA Standard at the time of this document release.

SPECIFICATIONS – VITA 67.3 SMPS (MATED PAIR)

ELECTRICAL			MECHANICAL	
VSWR	2 MHz to 40 GHz	1.5:1 Max	Axial Travel	.079"
Insertion Loss	2 MHz to 40 GHz	.12 * $\sqrt{(f(\text{GHz}))}$	Radial Float	± .010"
Cross Talk Requirement (dB MIN)	3 MHz to 30 MHz	≥ 140 dB	Engage Force	1.0 lbs (typ)
	30 MHz to 3 GHz	≥ 120 dB	Disengage Force	1.0 lbs (typ)
	3 GHz to 27 GHz	≥ 100 dB	Min Pitch (.047")	.145"
	27 GHz to 40 GHz	≥ 90 dB	Min Pitch (.086")	.155"
Power Handling	3 MHz to 30 MHz	30 dBm	Spring Force (Full Deflection)	2.6 lbs (typ)
	30 MHz to 3 GHz	20 dBm	Mating Cycles	500 Min
	3 GHz to 40 GHz	20 dBm	Vibration	MIL-STD-810

VITA 67.3 SMPS BACKPLANE CONNECTOR MODULES

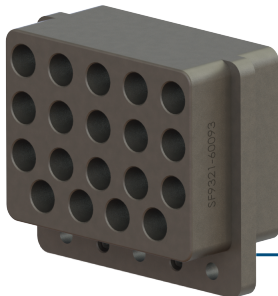

VITA 67.3 SMPS
19-Port Backplane
Connector Module
SV PN: SF9321-60093
*only for .047" cable



VITA 67.3 SMPS
12-Port Backplane
Connector Module
SV PN: SF9321-60084
*only for .047" cable

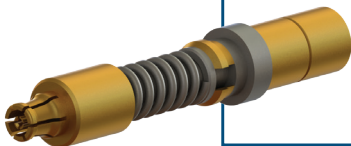

VITA 67.3 SMPS
Backplane Contact
For .086" Cable
SV PN: 3821-40024

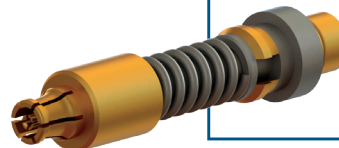

VITA 67.3 SMPS
Backplane Contact
For .047" Cable
SV PN: 3821-40023

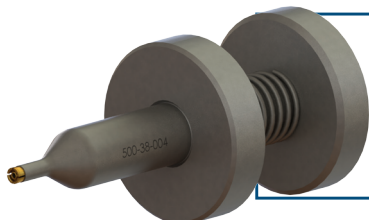

VITA 67.3 SMPS
Adapter Insertion/
Removal Tool
SV PN: 500-38-004

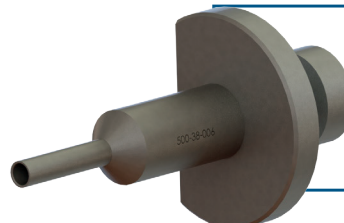

VITA 67.3 SMPS
Contact Removal Tool
SV PN: 500-38-006

INSTALLATION INSTRUCTIONS – VITA 67.3 SMPS BACKPLANE CONNECTOR CONTACTS

VITA 67.3 SMPS contacts have a similar ‘contact + adapter’ configuration to the SMPM series. However, in the SMPS series the Female-Female adapter is replaced by a Female-Male

adapter. This feature enables quick installation, removal, and centering of the contact relative to the connector module.

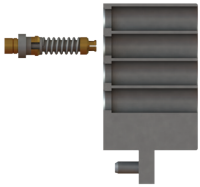

Figure 5
Contact Installation to Connector
Module (by hand)

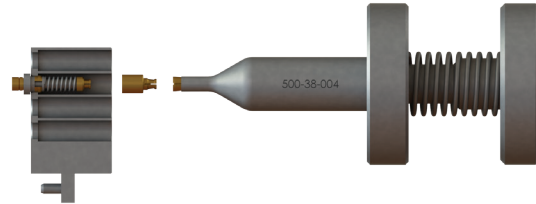

Figure 5.1
Adapter Installation to Contact
Uses Tool PN 500-38-004

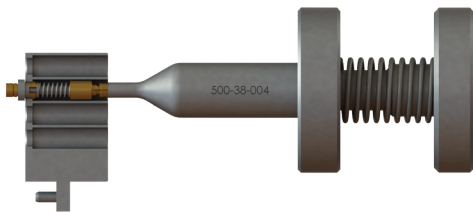

Figure 5.2
Adapter Fully Seated in Contact

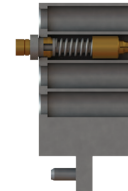

Figure 5.3
Final Assembly
Connector Module + Contact + Adapter

REMOVAL INSTRUCTIONS – VITA 67.3 SMPS BACKPLANE CONNECTOR CONTACTS

To remove the contacts (once adapters are extracted), removal tool PN 500-38-006 is used to compress the clip and plunge the contact from the housing.

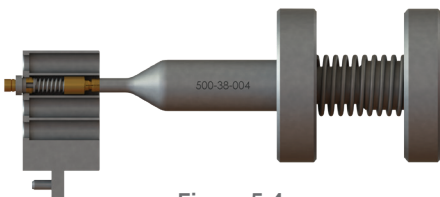

Figure 5.4
Adapter Removed From Contact
Uses Tool PN 500-32-007

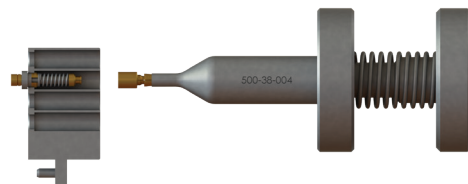

Figure 5.5
Adapter Removed From Contact

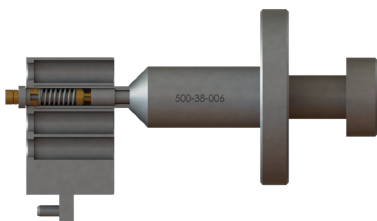

Figure 5.6
Contact Removed
Uses Tool PN 500-38-006

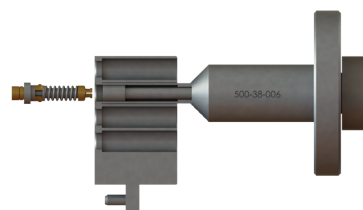
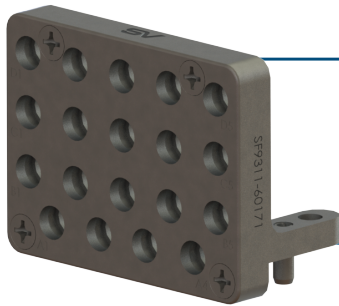

Figure 5.7
Contact Removed from Block

VITA 67.3 SMPS PLUG-IN CONNECTOR MODULES

VITA 67.3 SMPS Plug-In Connector Modules slightly differ from their SMPM predecessor. These contacts have either snap-in or flange mounted features which are tightly

pitched and stay aligned via precision holes in the Plug-In Connector Module.



VITA 67.3 SMPS
19-Port Plug-In Connector
Module
SV PN: SF9311-60171

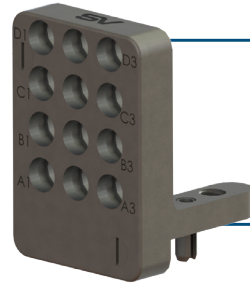

VITA 67.3 SMPS
12-Port Plug-In
Connector Module
SV PN: SF9311-60166

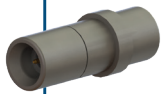

VITA 67.3 SMPS
Plug-In Adapter
SV PN: SF1138-6020

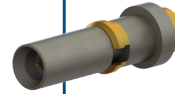

VITA 67.3 SMPS
Plug-In Male Contact For
.047" cable
SV PN: SF3811-60059

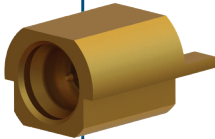

SMPS Male Edge Launch
Connector
SV PN: 3811-40003

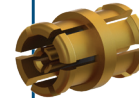

SMPS Female-Female
Adapter (.098")
SV PN: 1138-4001

SV Microwave also manufactures a complete line of D38999 coaxial contacts and cable assemblies. Our standard catalog items are listed below. The backplane connector module will often transition from the VITA 67 interface to a D38999 circular style connector on the chassis I/O panel. Ask us about termination options from VITA 67 to D38999.

Size	Interface	Cable	Type	Part Number
8	BMA	.086"	Socket	SF9411-6000
			Pin	SF9421-6000
12	SMPM	.047"	Socket	SF3211-6004
			Pin	3221-4002
		.086"	Socket	SF3251-60004
			Pin	3241-40004
16	SMPS	.047"	Socket	SF9911-60001
			Pin	9921-40001
		.086"	Socket	9351-40029
			Pin	9341-40043

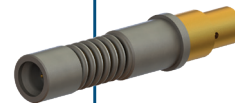

Size 12 SMPM Coaxial
Socket Contact
SV PN: SF3211-6004

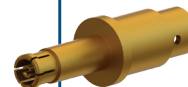

Size 12 SMPM Coaxial
Pin Contact
SV PN: 3221-4002

VITA 67.3 SMPS ELECTRICAL TEST DATA

Mated pair testing of Backplane and Plug-In Connector Modules confirms specification data. Below you will see our test configuration and data.

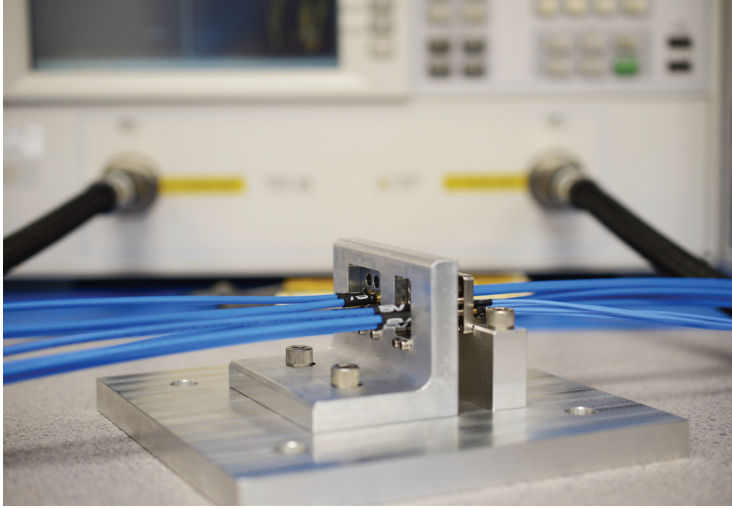

Figure 6
Test Setup for Mated Pair VITA 67.3
SMPS

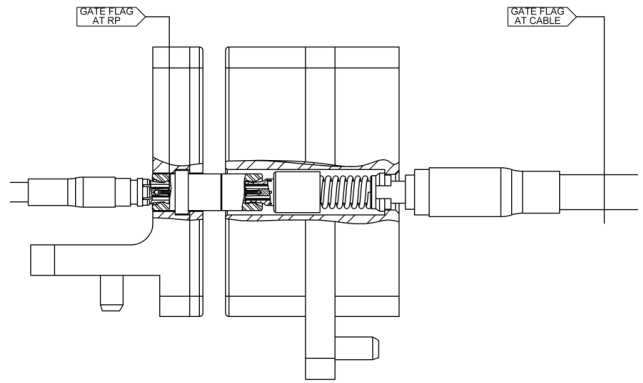

Figure 6.1
Gate flag position for SMPS Mated
Pair Measurement

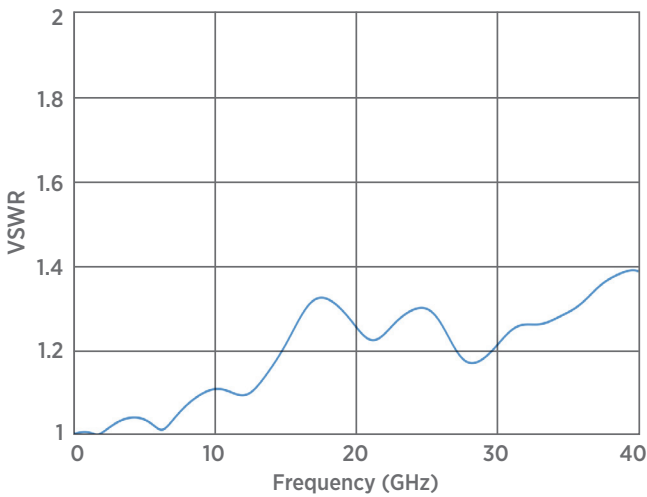

Figure 6.2
Gated VSWR Plot (typical)

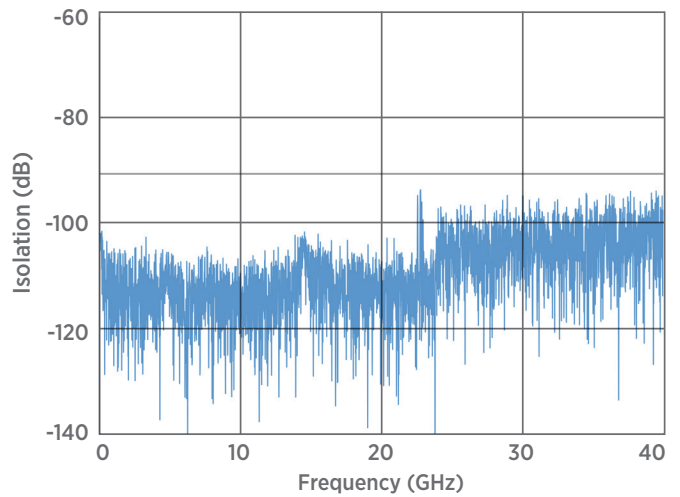

Figure 6.3
Electrical Isolation Plot
(Mated Pair)

VITA 67.1 AND 67.2 OVERVIEW

The VITA 67.1 and 67.2 Open VPX standards have enjoyed growing popularity in recent years as they are adopted to an increasing number of DOD programs. SV Microwave, as a leader in the development of 67.1 and 67.2 continues

to support these important products both directly and through a wide product offering in our distribution channel. Key features to include:

- Populated Plug-In Connector Modules inter-mate with Backplane Connector Modules across multiple qualified manufacturers
- Plug-In Connector Modules must be populated by that manufacturer's Plug-In Contact



VITA 67.1
4-Port (1/2 width) Backplane
Connector Module
SV PN: SF1132-6037

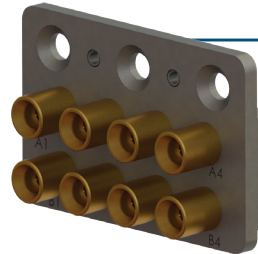

VITA 67.2
8-Port (full width) Backplane
Connector Module
SV PN: SF1132-6036



VITA 67.1
4-Port (1/2 width) Plug-In
Connector Module
SV PN: SF9321-60015



VITA 67.2
8-Port (full width) Plug-In
Connector Module
SV PN: SF9321-60013



VITA 67.1/67.2
Plug-In Contact
For .047" Cable
SV PN: 3221-40019



VITA 67.1/67.2
Plug-In Contact
For .085" Cable
SV PN: 3221-40022

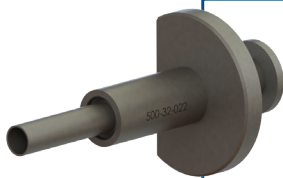

VITA 67.1/67.2
Contact Removal Tool
SV PN: 500-32-022

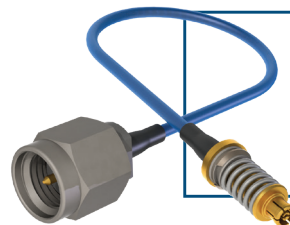

SMPM VITA to SMA Male
Cable Assembly
.047" Cable
PN: 7032-6728-060 (6")
PN: 7032-6728-120 (12")

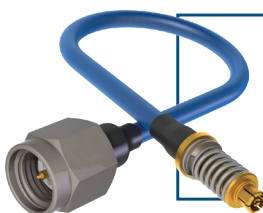

SMPM VITA to SMA Male
Cable Assembly
.085" Cable
PN: 7032-6729-060 (6")
PN: 7032-6729-120 (12")

VITA 67.1/2 & 67.3 CABLE ASSEMBLIES

SV Microwave offers a wide variety of fixed-length VITA 67.1/2 & 67.3 cable assemblies through our authorized distributors. A sample landing page is shown below.

Questions? We're here to help. 561.840.1800
Check Inventory | Sign-In



[PRODUCTS](#)
[RESOURCES](#)
[SUPPORT](#)



< BACK

SMPM Female VITA 67.1/67.2 to SMA Male Cable Assembly for .047 Cable (OAL 12")

Part Number 7032-6728-120



Inventory Status

In Stock At	QTY	ORDER	RFQ
Digi-Key Electronics [Ⓔ]	25	Buy Now	RFQ
Mouser Electronics [Ⓔ]	4	Buy Now	RFQ
Heilind Electronics [Ⓔ]	25	Buy Now	RFQ
TTI Inc Global Headquarters [Ⓔ]	99	Buy Now	RFQ

Customers Also Viewed

7032-6728-060



SMPM Female VITA 67.1/67.2 to SMA Male Cable Assembly f...

7032-6729-060



SMPM Female VITA 67.1/67.2 to SMA Male Cable Assembly f...

7032-6729-120



SMPM Female VITA 67.1/67.2 to SMA Male Cable Assembly f...

3221-40019



SMPM Female VITA 67.1/2 Plug-in Contact for .047 Cable

3221-40022





SMPM Female VITA 67.1/2 Plug-in Contact for .086 Cable

3221-40071



SMPM Female VITA 67.3 Plug-in Contact for .047 Cable

REQUEST QUOTE 

CONTACT US 

DATA SHEET 

CAD MODEL 

Technical Specs
Applications/Features/Benefits
Description

*Technical specifications are generic to the product series and are not part number specific.		
Electrical		
Impedance	50Ω	
Frequency	65 GHz	
VSWR	1.10:1 to 26.5 GHz typ.; 1.30:1 to 50 GHz typ.	
Insertion Loss	.07 √ f	
Shielding Effectiveness	≥ -80 dB	
Dielectric Withstanding Voltage	325 VRMS	
Mechanical		
	Smooth Bore	Full Detent
Matino Cycles	500	100



VITA 67.1/2 & 67.3 CABLE ASSEMBLIES

SV Microwave's Rapid Response Cable Builder offers custom VITA 67.1, 67.2 and 67.3 cable assemblies online. These cables are custom made and ship within 5 business

days. For more information, please visit our website at <http://svmicrowave.com/products/rf-cable-builder>



For more information, download the Rapid Response Application Note.

***Please note:** Cable assemblies ship in 5 days.

Lead time is extended for orders of 25 pieces or more or when a PO is used. Contact the factory for specific lead times at RapidResponse@svmicro.com.



Choose



Choose



Choose

copy this connector to other side

copy this connector to other side

Cable length inches Submit Clear

Delay Match (Additional \$20 charge)

PART NUMBER SEARCH

Search

ROHS COMPLIANT

PRODUCT DATA DRAWING

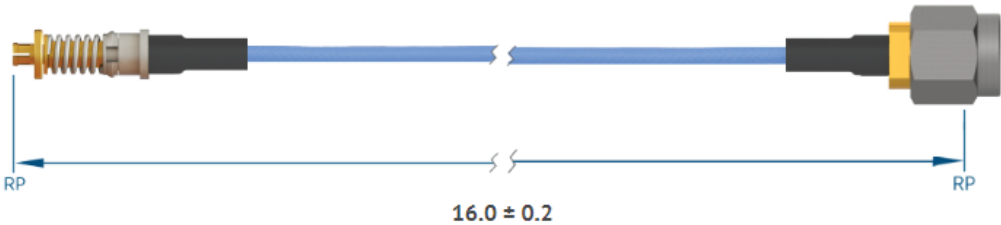

16.0 ± 0.2

MATERIAL:

CONNECTORS: VITA 67.3 SMPM Backplane Contact (3221-40071)
SMA Male (SF2911-60172)

CABLE: Flexible Ø.047 Cable

SHRINK TUBING: M23053/5

PERFORMANCE:

IMPEDANCE: 50 Ohms

FREQ RANGE: DC to 18 GHz

VSWR: 1.3:1 Max, DC to 18.0 GHz

INSERTION LOSS: 3.89 dB Max.

NOTES:

1. See individual data drawings for connector specifications
2. Dimensions shown are in inches

 <small>Amphenol 2400 Centrepark West Drive, Suite 100 West Palm Beach, FL 33409</small>	
TITLE:	VITA 67.3 SMPM Backplane Contact to SMA Male 16" Cable Assembly for Ø.047 Cable
DWG. NO.	FV67.3SMPM-047-MSSMA-160
DRAWN	2019-10-01 13:57:57



SV **MICROWAVE** Amphenol

O: 561.840.1800 | F: 561.842.6277

2400 Centrepark West Drive, West Palm Beach, FL 33409

www.svmicrowave.com