

DATA SHEET

TRANSIENT VOLTAGE SUPPRESSORS

AC/DC POWER SUPPLY

SMDJ-AT series

RoHS compliant & Halogen free

Product specification— February 21, 2021 V.2



Transient Voltage Suppressors (TVS) Data Sheet

Features

- For surface mounted applications in order to optimize board space
- Low profile package
- Built-in strain relief
- Glass passivated junction
- Low inductance
- Excellent clamping capability
- 3000W peak pulse power capability at 10/1000 μ s waveform, repetition rate (duty cycle): 0.01%
- Fast response time
- Typical I_R less than 2 μ A above 10V
- High Temperature soldering: 260 $^{\circ}$ C/10 seconds at terminals
- Plastic package has underwriters laboratory flammability 94V-0
- Meets MSL level 1, per J-STD-020
- Safety certification: UL: E244458
- AEC-Q101 qualified
- IEC61000-4-2 ESD 30KV Air, 30KV contact compliance



Mechanical Data

- Case: JEDEC DO-214AB. Molded plastic over glass passivated junction
- Terminal: Tin plated, solderable per MIL-STD-750, Method 2026
- Polarity: Color band denotes cathode except bi-directional models
- Standard Packaging: 16mm tape (EIA STD RS-481)
- Weight: 0.26g

Applications

- I/O interface
- AC/DC power supply
- Low frequency signal transmission line (RS232, RS485, etc.)

Maximum Ratings and Characteristics

Ratings at 25 $^{\circ}$ C ambient temperature unless otherwise specified.

Rating	Symbol	Value	Units
Peak pulse power dissipation at 10/1000 μ s waveform (Note1, Note2, Fig.1)	P_{PPM}	Minimum 3000	Watts
Peak pulse current of at 10/1000 μ s waveform (Note 1, Fig.3)	I_{PPM}	See Table	Amps
Steady state power dissipation at $T_A=50^{\circ}$ C (Fig.5)	$P_{M(AV)}$	6.5	Watts
Peak forward surge current, 8.3ms single half sine-wave superimposed on rated load, (JEDEC Method) (Note3, Fig.6)	I_{FSM}	300	Amps
Operating junction and Storage Temperature Range.	T_J, T_{STG}	-55 to +150	$^{\circ}$ C
Typical thermal resistance junction to lead	$R_{\theta JL}$	15	$^{\circ}$ C/W
Typical thermal resistance junction to ambient	$R_{\theta JA}$	75	$^{\circ}$ C/W

Notes: 1. Non-repetitive current pulse, per Fig.3 and derated above $T_A=25^{\circ}$ C per Fig.2.

2. Mounted on 8.0mm \times 8.0mm copper pads to each terminal.

3. 8.3ms single half sine-wave, or equivalent square wave, duty cycle=4 pulses per minutes maximum.

Dimensions (SMC/DO-214AB)

	Symbol	Millimeters		Inches	
		Min.	Max.	Min.	Max.
	L	6.60	7.11	0.260	0.280
	D	5.59	6.22	0.220	0.245
	D1	2.90	3.20	0.114	0.126
	T	7.75	8.13	0.305	0.320
	T1	0.76	1.52	0.030	0.060
	d	-	0.203	-	0.008
	H	2.20	2.80	0.087	0.110
	H1	2.06	2.62	0.079	0.103

Electrical Characteristics (T_A=25°C)

Part Number		Device Marking Code		Reverse Stand-Off Voltage	Breakdown Voltage @I _T	Test Current	Maximum Clamping Voltage @I _{PP}	Peak Pulse Current	Reverse Leakage @V _{RWM}
Unidirectional	Bidirectional	UNI	BI	V _{RWM} (V)	V _{BR} (V)	I _T (mA)	V _C (V)	I _{PP} (A)	I _R (μA)
SMDJ5.0A-AT	SMDJ5.0CA-AT	RDE	DDE	5.0	6.40~7.00	10	9.2	326.1	800
SMDJ6.0A-AT	SMDJ6.0CA-AT	RDG	DDG	6.0	6.67~7.37	10	10.3	291.3	800
SMDJ6.5A-AT	SMDJ6.5CA-AT	RDK	DDK	6.5	7.22~7.98	10	11.2	267.9	500
SMDJ7.0A-AT	SMDJ7.0CA-AT	PDM	DDM	7.0	7.78~8.60	10	12.0	250.0	200
SMDJ7.5A-AT	SMDJ7.5CA-AT	PDP	DDP	7.5	8.33~9.21	1	12.9	232.6	100
SMDJ8.0A-AT	SMDJ8.0CA-AT	PDR	DDR	8.0	8.89~9.83	1	13.6	220.6	50
SMDJ8.5A-AT	SMDJ8.5CA-AT	PDT	DDT	8.5	9.44~10.40	1	14.4	208.3	20
SMDJ9.0A-AT	SMDJ9.0CA-AT	PDV	DDV	9.0	10.00~11.10	1	15.4	194.8	10
SMDJ10A-AT	SMDJ10CA-AT	PDX	DDX	10.0	11.10~12.30	1	17.0	176.5	5
SMDJ11A-AT	SMDJ11CA-AT	PDZ	DDZ	11.0	12.20~13.50	1	18.2	164.8	2
SMDJ12A-AT	SMDJ12CA-AT	PEE	DEE	12.0	13.30~14.70	1	19.9	150.8	2
SMDJ13A-AT	SMDJ13CA-AT	PEG	DEG	13.0	14.40~15.90	1	21.5	139.5	2
SMDJ14A-AT	SMDJ14CA-AT	PEK	DEK	14.0	15.60~17.20	1	23.2	129.3	2
SMDJ15A-AT	SMDJ15CA-AT	PEM	DEM	15.0	16.70~18.50	1	24.4	123.0	2
SMDJ16A-AT	SMDJ16CA-AT	PEP	DEP	16.0	17.80~19.70	1	26.0	115.4	2
SMDJ17A-AT	SMDJ17CA-AT	PER	DER	17.0	18.90~20.90	1	27.6	108.7	2
SMDJ18A-AT	SMDJ18CA-AT	PET	DET	18.0	20.00~22.10	1	29.2	102.7	2
SMDJ20A-AT	SMDJ20CA-AT	PEV	DEV	20.0	22.20~24.50	1	32.4	92.6	2
SMDJ22A-AT	SMDJ22CA-AT	PEX	DEX	22.0	24.40~26.90	1	35.5	84.5	2

Transient Voltage Suppressors SMDJ-AT

Part Number		Device Marking Code		Reverse Stand-Off Voltage	Breakdown Voltage @ I_T	Test Current	Maximum Clamping Voltage @ I_{PP}	Peak Pulse Current	Reverse Leakage @ V_{RWM}
Unidirectional	Bidirectional	UNI	BI	$V_{RWM}(V)$	$V_{BR}(V)$	$I_T(mA)$	$V_C(V)$	$I_{PP}(A)$	$I_R(\mu A)$
SMDJ24A-AT	SMDJ24CA-AT	PEZ	DEZ	24.0	26.70~29.50	1	38.9	77.1	2
SMDJ26A-AT	SMDJ26CA-AT	PFE	DFE	26.0	28.90~31.90	1	42.1	71.3	2
SMDJ28A-AT	SMDJ28CA-AT	PFG	DFG	28.0	31.10~34.40	1	45.4	66.1	2
SMDJ30A-AT	SMDJ30CA-AT	PFK	DFK	30.0	33.30~36.80	1	48.4	62.0	2
SMDJ33A-AT	SMDJ33CA-AT	PFM	DFM	33.0	36.70~40.60	1	53.3	56.3	2
SMDJ36A-AT	SMDJ36CA-AT	PFP	DFP	36.0	40.00~44.20	1	58.1	51.6	2
SMDJ40A-AT	SMDJ40CA-AT	PFR	DFR	40.0	44.40~49.10	1	64.5	46.5	2
SMDJ43A-AT	SMDJ43CA-AT	PFT	DFT	43.0	47.80~52.80	1	69.4	43.2	2
SMDJ45A-AT	SMDJ45CA-AT	PFV	DFV	45.0	50.00~55.30	1	72.7	41.3	2
SMDJ48A-AT	SMDJ48CA-AT	PFX	DFX	48.0	53.30~58.90	1	77.4	38.8	2
SMDJ51A-AT	SMDJ51CA-AT	PFZ	DFZ	51.0	56.70~62.70	1	82.4	36.4	2
SMDJ54A-AT	SMDJ54CA-AT	PGE	DGE	54.0	60.00~66.30	1	87.1	34.4	2
SMDJ58A-AT	SMDJ58CA-AT	PGG	DGG	58.0	64.40~71.20	1	93.6	32.1	2
SMDJ60A-AT	SMDJ60CA-AT	PGK	DGK	60.0	66.70~73.70	1	96.8	31.0	2
SMDJ64A-AT	SMDJ64CA-AT	PGM	DGM	64.0	71.10~78.60	1	103.0	29.1	2
SMDJ70A-AT	SMDJ70CA-AT	PGP	DGP	70.0	77.80~86.00	1	113.0	26.5	2
SMDJ75A-AT	SMDJ75CA-AT	PGR	DGR	75.0	83.30~92.10	1	121.0	24.8	2
SMDJ78A-AT	SMDJ78CA-AT	PGT	DGT	78.0	86.70~95.80	1	126.0	23.8	2
SMDJ85A-AT	SMDJ85CA-AT	PGV	DGV	85.0	94.40~104.00	1	137.0	21.9	2
SMDJ90A-AT	SMDJ90CA-AT	PGX	DGX	90.0	100.00~111.00	1	146.0	20.5	2
SMDJ100A-AT	SMDJ100CA-AT	PGZ	DGZ	100.0	111.00~123.00	1	162.0	18.5	2
SMDJ110A-AT	SMDJ110CA-AT	PHE	DHE	110.0	122.00~135.00	1	177.0	16.9	2
SMDJ120A-AT	SMDJ120CA-AT	PHG	DHG	120.0	133.00~147.00	1	193.0	15.5	2
SMDJ130A-AT	SMDJ130CA-AT	PHK	DHK	130.0	144.00~159.00	1	209.0	14.4	2
SMDJ150A-AT	SMDJ150CA-AT	PHM	DHM	150.0	167.00~185.00	1	243.0	12.3	2
SMDJ160A-AT	SMDJ160CA-AT	PHP	DHP	160.0	178.00~197.00	1	259.0	11.6	2
SMDJ170A-AT	SMDJ170CA-AT	PHR	DHR	170.0	189.00~209.00	1	275.0	10.9	2
SMDJ180A-AT	SMDJ180CA-AT	HHT	IHT	180.0	201.00~222.00	1	292.0	10.3	2
SMDJ190A-AT	SMDJ190CA-AT	HHV	IHV	190.0	211.00~233.00	1	308.0	9.7	2
SMDJ200A-AT	SMDJ200CA-AT	HHX	IHX	200.0	224.00~247.00	1	324.0	9.3	2
SMDJ210A-AT	SMDJ210CA-AT	HHZ	IHZ	210.0	237.00~263.00	1	340.0	8.8	2
SMDJ220A-AT	SMDJ220CA-AT	HIE	IIE	220.0	246.00~272.00	1	356.0	8.4	2

Ratings and Characteristic Curves ($T_A=25^\circ\text{C}$ unless otherwise noted)

Figure 1. Peak Pulse Power Rating Curve

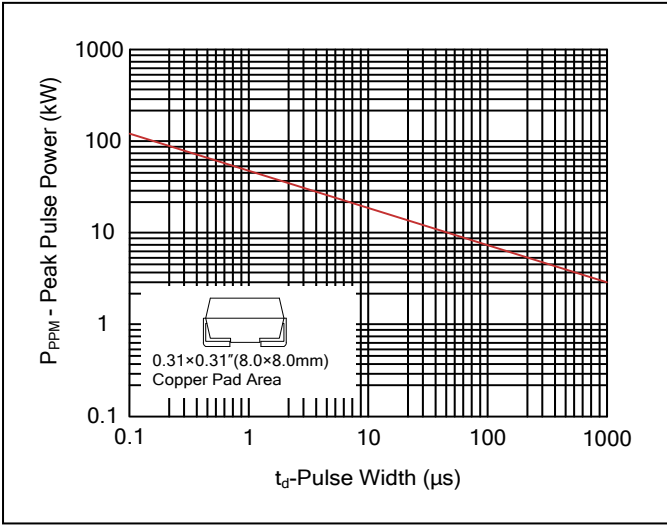

Figure 2. Pulse Derating Curve

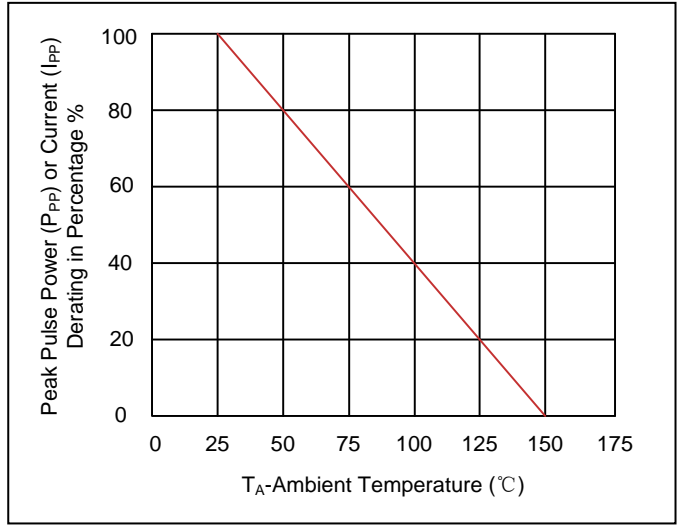

Figure 3. Pulse Waveform

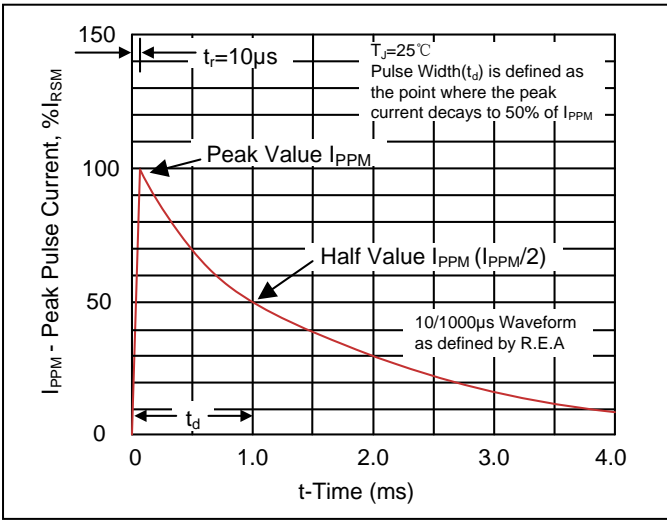

Figure 4. Typical Junction Capacitance

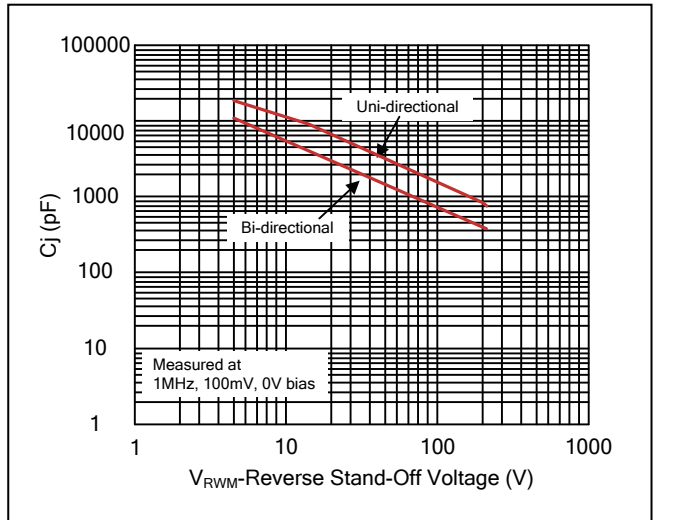

Figure 5. Steady State Power Dissipation Derating Curve

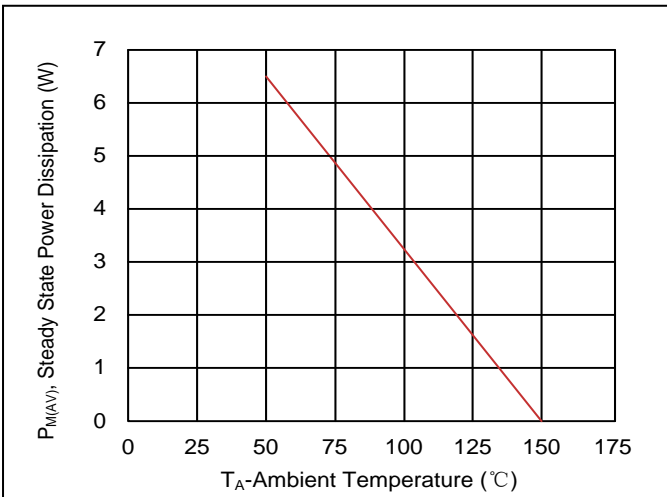
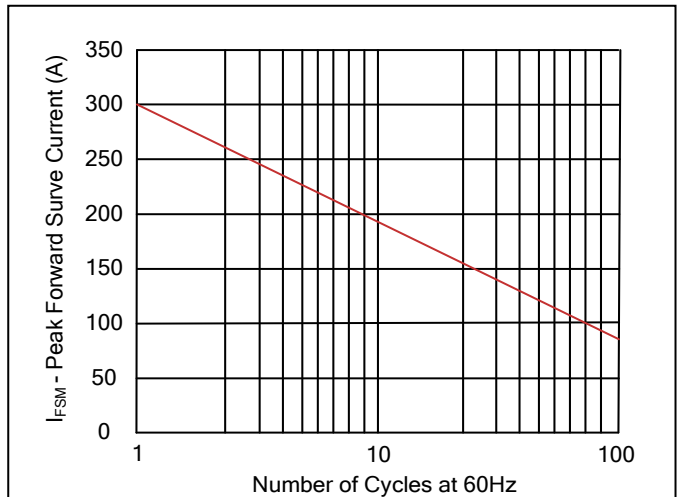
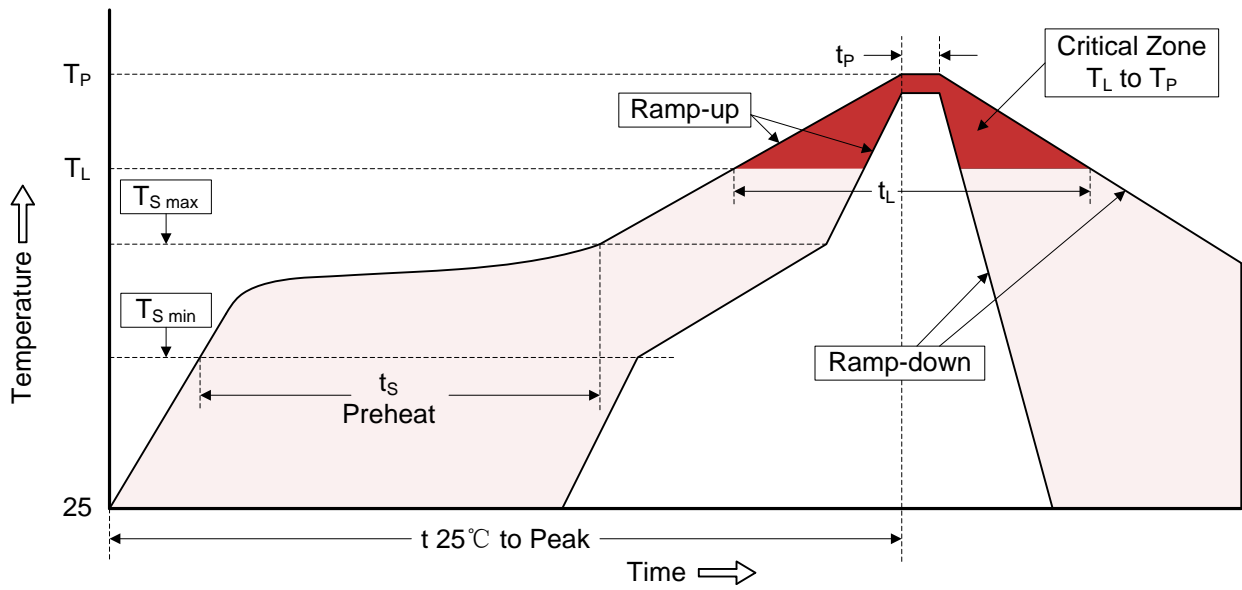

Figure 6. Maximum Non-Repetitive Forward Surge Current Uni-Directional Only



Recommended Soldering Conditions

Reflow Soldering



Recommended Conditions

Profile Feature	Pb-Free Assembly
Average ramp-up rate (T_L to T_P)	3°C/second max.
Preheat	
-Temperature Min ($T_{S\ min}$)	150°C
-Temperature Max ($T_{S\ max}$)	200°C
-Time (min to max) (t_s)	60-180 seconds
$T_{S\ max}$ to T_L	
-Ramp-up Rate	3°C/second max.
Time maintained above:	
-Temperature (T_L)	217°C
-Time (t_L)	60-150 seconds
Peak Temperature (T_P)	260°C
Time within 5°C of actual Peak Temperature (t_P)	20-40 seconds
Ramp-down Rate	6°C/second max.
Time 25°C to Peak Temperature	8 minutes max.

Marking Code

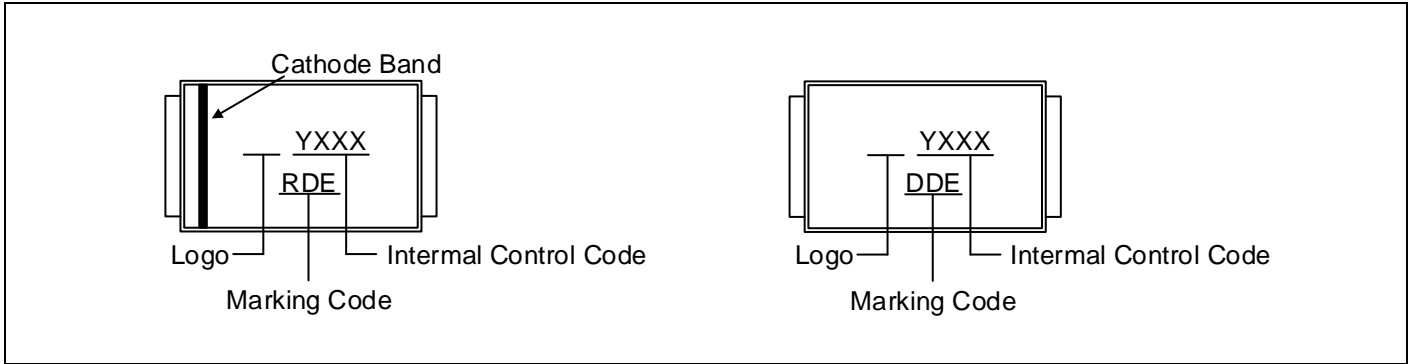

Part Number Code

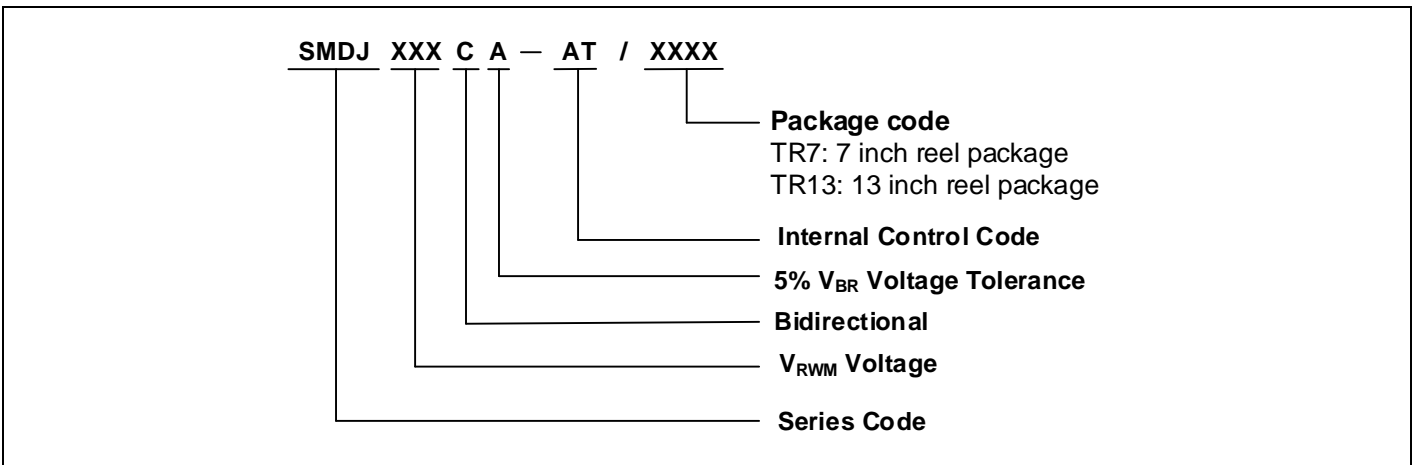

Ordering Code for Different Package

7 inc reel package: Add suffix /TR7" at the end of the part number, such as DJXXXCA-AT/TR7

13 inc reel package: Add suffix /TR13" at the end of the part number, such as SMDJXXXCA-AT/TR13

Packaging

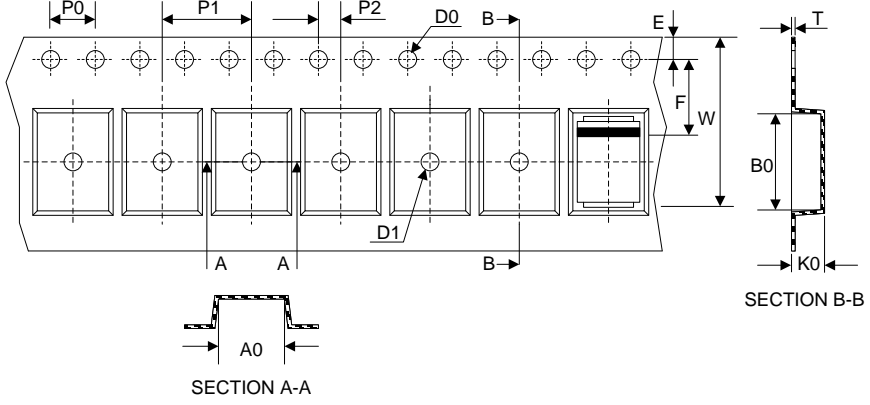
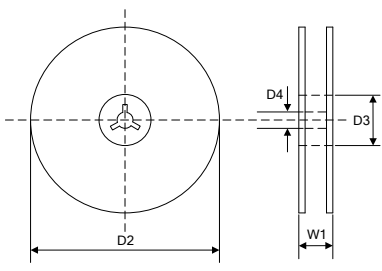
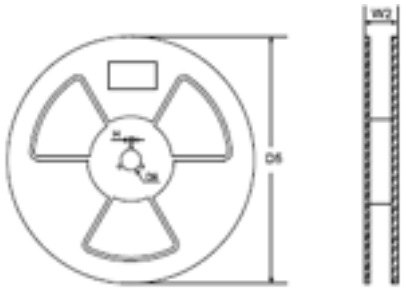
Tape	Symbol	Dimension (mm)
	W	16.00±0.20
	P0	4.00±0.10
	P1	8.00±0.10
	P2	2.00±0.10
	D0	Φ1.5±0.10
	D1	Φ1.5±0.10
	E	1.75±0.10
	F	7.50±0.10
	A0	6.27±0.10
	B0	8.30±0.10
	K0	3.15±0.15
	T	0.30±0.05
	<p>7" Reel</p> 	D2
D3		Φ50.0Min.
D4		Φ13.0±0.5
W1		20.0±2.0
Quantity: 500PCS		
<p>13" Reel</p> 	D5	Φ330.0±2.0
	D6	Φ13.5±0.5
	H	2.5±1.0
	W2	20.0±2.0
	Quantity: 3000PCS	