

Product Selection Guide

Circuit protection component

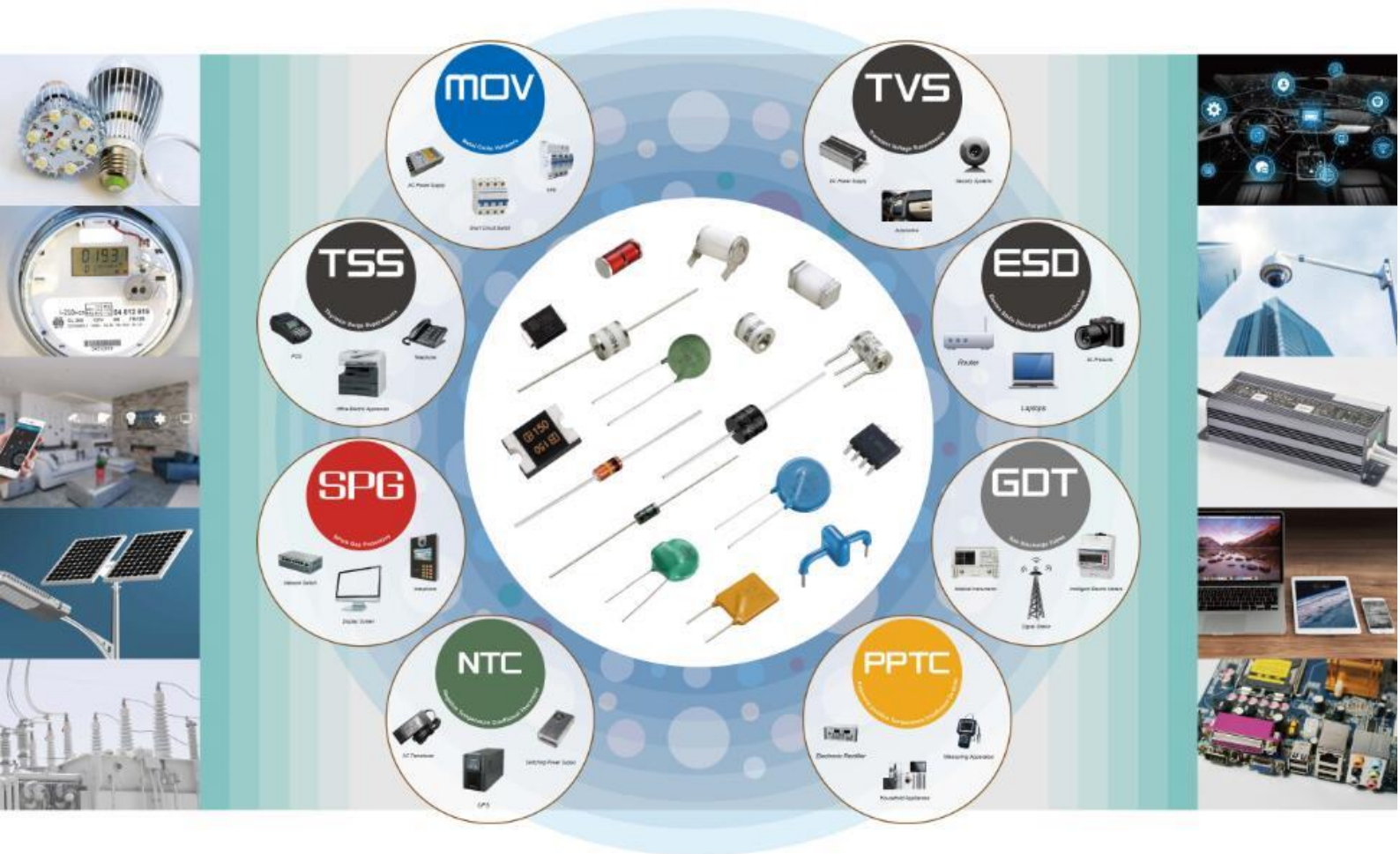

Contents

CONTENTS	2
1. INTRODUCTION OF VARIOUS PROTECTION COMPONENTS	4
1.1 CLASSIFICATION OF PROTECTION COMPONENTS	4
1.2 TRANSIENT VOLTAGE SUPPRESSORS (TVS)	6
1.3 ELECTROSTATIC DISCHARGE PROTECTION DEVICES (ESD)	7
1.4 METAL OXIDE VARISTORS (MOV)	8
1.5 GAS DISCHARGE TUBES (GDT)/ SPARK GAP PROTECTORS(SGP)	9
1.6 THYRISTOR SURGE SUPPRESSORS (TSS)	10
1.7 POLYMERIC POSITIVE TEMPERATURE COEFFICIENT THERMISTORS (PPTC)	11
1.8 NEGATIVE TEMPERATURE COEFFICIENT THERMISTOR (NTC & SENSOR)	12
1.9 COMPREHENSIVE COMPARISON AMONG OVERVOLTAGE PROTECTION COMPONENTS.....	14
2. SURGE PROTECTION PRINCIPLE	16
3. TYPICAL APPLICATION CASES	18
3.1 POWER SYSTEM TYPICAL APPLICATION CASES.....	18
3.1.1 AC POWER PORT SURGE PROTECTION	18
3.1.2 PROTECTION OF OTHER PORTIONS OF THE POWER SYSTEM.....	18
3.1.3 DC POWER PORT SURGE PROTECTION	19
3.2 COMMUNICATION INTERFACES PROTECTION	20
3.2.1 100M/1000M RJ45 PORT (ETHERNET) PROTECTION	20
3.2.2 100M /1000M PoE (POWER ON ETHERNET) PROTECTION.....	21
3.2.3 ANTENNA (RF PORT) PROTECTION	21
3.2.4 USB2.0 PORT ESD PROTECTION	22
3.2.5 USB3.0 PORT ESD PROTECTION	22
3.2.6 USB TYPE-C ESD PROTECTION	23
3.2.7 HDMI PORT ESD PROTECTION.....	23
3.2.8 DISPLAY PORT ESD PROTECTION	24
3.2.9 VGA PORT ESD PROTECTION.....	24
3.2.10 DVI PORT ESD PROTECTION	25
3.2.11 LVDS ESD PROTECTION	25
3.2.12 SIM CARD ESD PROTECTION	25
3.2.13 SD CARD ESD PROTECTION	26
3.2.14 SCART CARD ESD PROTECTION	26
3.2.15 RJ11 PORT SURGE PROTECTION	26
3.2.16 CAN BUS PROTECTION.....	27
3.2.17 LIN BUS ESD PROTECTION.....	27
3.2.18 BNC PORT PROTECTION.....	27
3.2.19 RS485 PORT PROTECTION.....	28
3.2.20 YCRCB/YPRPB PORT ESD PROTECTION	28
3.2.21 S-VIDEO ESD PROTECTION.....	29
3.2.22 HEADPHONE INTERFACE ESD PROTECTION	29
3.2.23 KEYS/BUTTONS ESD PROTECTION.....	29
3.2.24 I/O PORT ESD PROTECTION.....	30

3.2.25	RS232 PORT ESD PROTECTION.....	30
3.2.26	AV TERMINAL ESD PROTECTION.....	30
3.2.27	LCD MODULE ESD PROTECTION.....	31
4.	YAGEO TVS PRODUCTS LINE.....	32
5.	YAGEO MOV PRODUCTS LINE.....	34
6.	YAGEO GDT&SPG PRODUCTS LINE.....	36
7.	YAGEO ESD PRODUCTS LINE.....	38
8.	YAGEO NTC PRODUCTS LINE.....	43
9.	YAGEO TSS PRODUCTS LINE.....	43
10.	YAGEO PPTC PRODUCTS LINE.....	44
11.	APPENDIX: SUMMARY OF TEST STANDARDS.....	45
11.1	IEC61000-4-2 : ESD.....	45
11.2	IEC61000-4-5: SURGE.....	45

1. Introduction of Various Protection Components

1.1 Classification of Protection Components

Yageo has eight types of circuit protection components, they are as follows.

- ✧ Transient Voltage Suppressors (TVS)
- ✧ Metal Oxide Varistors (MOV)
- ✧ Electrostatic Discharge Protection Devices (ESD)
- ✧ Gas Discharge Tubes (GDT)
- ✧ Spark Gap Protectors (SPG)
- ✧ Thyristor Surge Suppressors (TSS)
- ✧ Polymeric Positive Temperature Coefficient Thermistors (PPTC)
- ✧ Negative Temperature Coefficient Thermistors (NTC)

According to the working principle of the product, we can divide the products above into 3 categories: clamping type overvoltage protection components (TVS, ESD, MOV), switching type overvoltage protection components (GDT, SPG, TSS), and overcurrent protection component (PPTC, NTC).

Clamping Type Overvoltage Protection Components

The volt-ampere characteristic curve of the clamping overvoltage protection component is shown in Figure 1.1. When the voltage reaches the breakdown voltage of the clamping overvoltage protection component, its resistance will be reduced to the low impedance instantaneously and the surge current will be discharged so that the surge voltage can be limited to a low level. The characteristic of the clamping overvoltage protection component is that the clamping voltage will be higher than the breakdown voltage of the component after the component is turned on. The clamping voltage at both ends of the component is proportional to the instantaneous surge current. The clamping over-voltage protection components are often used for the overvoltage protection of power cords and low-frequency communication circuits.

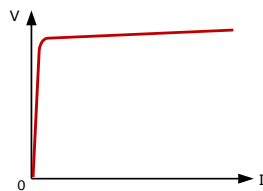

Figure 1.1 I-V Curve of the Clamping Overvoltage Protection Component

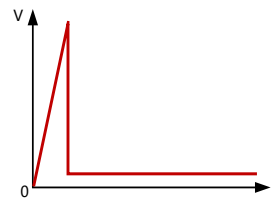

Figure 1.2 I-V Curve of the Switching Overvoltage Protection Component

Switching Type Overvoltage Protection Components

The volt-ampere characteristic curve of the switching overvoltage protection component is shown in Figure 1.2. When the voltage reaches the breakdown voltage of the switching overvoltage protection component, its resistance will be reduced to the low impedance instantaneously and the surge current will be discharged so that the surge voltage can be limited to a very low level. The characteristic of the switching overvoltage protection component is that the voltage at both ends of the component after the component is turned on will be lower than the breakdown voltage of the component. The switching overvoltage protection components are commonly used for the surge protection of high frequency signal lines in the communication system.

Overcurrent Protection Components (PPTC & NTC)

NTC and PPTC are always connected in series with the load to be an overcurrent protector. PPTC is an overcurrent protection component that can be applied repeatedly. It is often used for the overcurrent protection of power cords with small current inputs or it is used as a decoupling component between two-stage overvoltage protective elements.

NTC is not only a temperature sensing component but also an overcurrent protector to limit inrush current in power supplier. NTC can absorb the energy of the inrush current to protect circuits.

1.2 Transient Voltage Suppressors (TVS)

TVS (Transient Voltage Suppressor) is an integrated device of a single PN junction or multiple PN junctions fabricated by the semiconductor diffusion process. TVS can be divided into two types, including unidirectional TVS and bidirectional TVS. Unidirectional TVS is generally applied to DC power supply circuits and bidirectional TVS is applied to circuits with an alternating voltage. In a DC circuit, the unidirectional TVS is reversely parallel to the circuit. When the circuit is working normally, TVS is in the off state (high-impedance state) and it won't affect the normal operation of the circuit. When an abnormal overvoltage occurs in the circuit and reaches the TVS (avalanche) breakdown voltage, TVS will change from the high impedance state to the low impedance state rapidly, discharging the transient overcurrent caused by the abnormal overvoltage to the ground. Besides, the low clamping voltage between both ends of the PN junction will be maintained, thus preventing the circuit of the post-stage from damage caused by the abnormal overvoltage. When the abnormal overvoltage disappears, the resistance of TVS will return to the high impedance state.

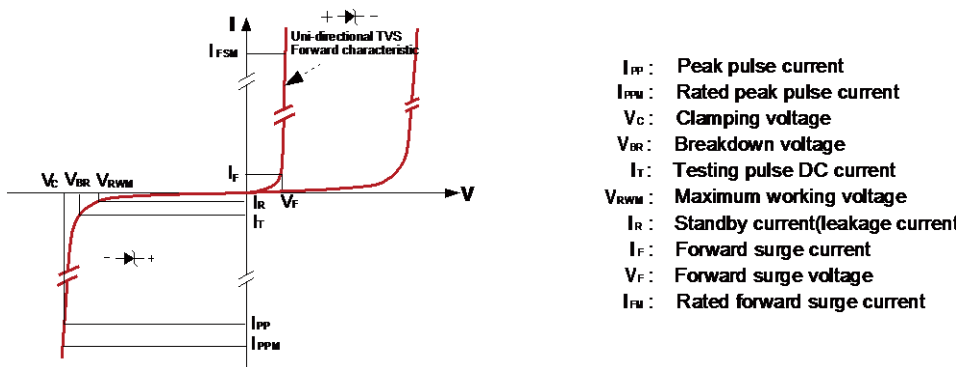
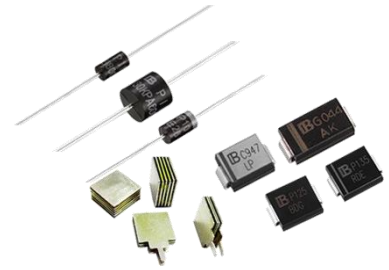

Figure 1.2.1 Unidirectional TVS Volt-Ampere Characteristic Curve

The volt-ampere characteristic curve of TVS and the related parameters are shown in Figure 1.2.1. The first quadrant of the volt-ampere characteristic curve of bidirectional TVS has the opposite polarity to the third quadrant but their characteristics are similar. When TVS is reverse biased, it has two operating modes: standby (high impedance) or clamped (relatively low impedance), as shown in the third quadrant of Figure 1.2.1. In the standby state, the current flowing through TVS is called the standby current or leakage current (I_R), which varies with the junction temperature. In the volt-ampere characteristic curve of TVS, the transition from high impedance (standby) to low impedance (clamped) is the beginning of the avalanche breakdown. Under this conduction state, TVS will have a large transient current and maintain a relatively low clamping voltage that is high than the breakdown voltage of the semiconductor PN junction.

Cautions for TVS Selection

- **Maximum Operating Voltage V_{RWM} :** The cut-off voltage of the TVS diode should be greater than the maximum operating voltage or the signal voltage level in the circuit. If the selected cut-off voltage is too low, it will affect the normal operation of circuits and the life of TVS.
- **Peak Yageo Current I_{PP} :** When the TVS diode is used alone, its appropriate type should be selected per the maximum surge current that may occur in circuits. For TVS of the same voltage, the greater the power, the larger the I_{PP} . The greater the power, the better the TVS protection on circuits.
- **Clamping Voltage V_C :** It should be less than the maximum transient safety voltage that can be withstood by the circuit. V_C is proportional to the breakdown voltage of TVS and I_{PP} .
- **Leakage Current I_R :** Special attention should be paid to this parameter in communication lines and low-power circuits.







1.3 Electrostatic Discharge Protection Devices (ESD)

ESD is also known as TVS array. ESD is a multi-channel or single-channel ESD protection device with multiple TVS dies or diodes in different layouts (Table 1.3.1). It is mainly used for the ESD protection of various communication interfaces such as USB, HDMI, RS485, RS232, VGA, RJ11, RJ45, BNC, SIM card, SD card, etc. ESD components have diverse packages, which cover from the single-channel DFN0201 to the multi-channel SOIC-16, QFN-10, etc. Circuit design engineers can choose ESD with different packages according to the board layout and the interface type.

Yageo ESD products can be divided into three categories according to the junction capacitance:

- I. Standard capacitance products
- II. Low capacitance products
- III. Ultra-low capacitance products

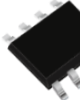
Table 1.3.1- Examples of ESD package and internal structure

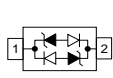
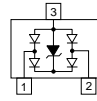
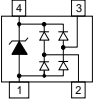
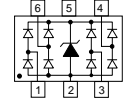
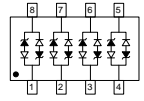
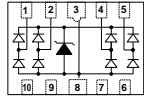
					
					
SOD-323	SOT-23	SOT-143	SOT23-6L	SOIC-8	QFN-10

Features

- ✚ ESD is a clamping type over-voltage protection component, used for ESD protection or low surge protection.
- ✚ Working voltage is designed according to the working voltage of the protected IC, such as 2.8V, 3.3V, 5V, 12V, 15V, 24V, 36V, and so on.
- ✚ Low capacitance, low to 0.4pF, used for high speed data line will not influence the communication data quality.
- ✚ Can be designed to small sizes, such as 0201, 0402 package type saving PCB space.
- ✚ ESD has high flexibility to design parameters such as capacitance, package type, surge withstanding current, and so on according to application requirements.
- ✚ There are a variety of different package types, such as QFN-0201, SOD-882, DFN1006-3L, SOT-523, SOD-523, QFN-10, SOD-123S, SOD-323, SOT-23, SOT-143, SOT-363, SOT23-6L, SOIC-8, SOIC-16 and so on.

Cautions for ESD Selection

Package type: proper package types can be selected according to the circuit design layout and the number of protected channels. The package size can reflect the protection level of the component. The larger the package size, the higher the protection level of the component, and vice versa.

Junction Capacitance (C_j): High-speed data lines should select ESD with small junction capacitance as much as possible, otherwise the communication quality will be affected.

Reverse stand-off voltage V_{RWM} : The V_{RWM} of the ESD should be greater than the maximum working voltage of the protected circuit, otherwise it will affect the normal operation of the protected circuit. For a circuit with a working voltage of 5V, we should select the ESD product V_{RWM} voltage equal or greater than 5V.

1.4 Metal Oxide Varistors (MOV)

Varistors are used in the surge protection of low-voltage electrical devices in the market are mostly varistors with zinc oxide as the main material. MOV is a kind of polycrystalline semiconductor ceramic device which is mainly made of zinc oxide and doped with various metal oxides through the typical electronic ceramic process. MOV has a symmetrical volt-ampere characteristic curve (as shown in Figure. 1.4). The current flowing through MOV increases exponentially with the increase in the voltage across the MOV. When MOV is applied, it is generally connected in parallel in the circuits. When the circuit works normally, it is in a high-impedance state and does not affect the normal operation of the circuit. When an abnormal transient voltage occurs in the circuit and reaches its on-state voltage (varistor voltage), MOV will change from the high-impedance state to the low-resistance state, discharging the instantaneous overcurrent caused by the abnormal transient overvoltage to the ground. At the same time, the abnormal transient voltage is clamped within a safe level to protect the post-stage circuit from the abnormal transient voltage. MOV has a high transient pulse absorption capability and a large junction capacitance, which is generally used for the lightning protection of AC input terminals. Because MOV's surge absorption capability depends on its physical size, different transient surge current values can be obtained by producing MOV of different chip diameters. The diameter of our MOV products can meet the requirements of 5mm~53mm. Yageo MOV can be divided into three series: standard MOV(KD series), high temperature MOV(KK and KH series), and TMOV (KN/KM/KE series, temperature fuses integrated into MOVs). The volt-ampere characteristic curve and parameters of MOV are shown in Figure 1.4.

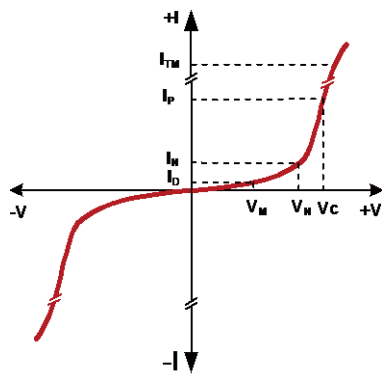

- I_P** : Peak pulse current under specified wave form
- V_C** : Peak voltage across MOV measured at the specified pulse peak current (I_P)
- I_N** : Pulse peak current at a specified time
- V_N** : Peak voltage value across MOV measured within a specified duration at a specified peak pulse current (I_N), I_N is typically 1mA (8/20μs)
- I_D** : Standby current (leakage current)
- V_M** : Voltage can be continuously applied at a specified temperature
- I_M** : Maximum rated value of a specified waveform pulse which can be applied in a single time without causing MOV failure .

Figure 1.4 MOV's Volt-Ampere Characteristic Curve

Cautions for MOV Selection

Varistor Voltage (V_{1mA}/V_N): the selection of the varistor voltage should consider factors such as power supply voltage fluctuation, varistor voltage accuracy, varistor aging coefficient; it generally follows the following selection formula:

$$V_{1mA} \geq \frac{(1+a)}{(1-b)(1-c)} \cdot V_P$$

- a : Power voltage fluctuation coefficient (0.1~0.3)
- b : Varistor voltage tolerance(0.1~0.2)
- c : Varistor aging factor , generally take 0.1
- V_P : Power input peak voltage

For example, the 110VAC input MOV voltage should be selected as follows:

$$V_{1mA} \geq \frac{[1+ (0.1-0.3)]}{(1-0.1)(1-0.1)} * 110 * 1.414 = (211-249)V$$

The value of "a" depends on the stability of the power grid. It can be selected to be small if the power grid fluctuation is small. It can also be selected to be large if the power grid fluctuation is large in remote areas or industrial application environments.

Maximum Peak Pulse Current (I_{PP}): MOV will be aging during long-term usage. In practical applications, it is necessary to consider the derating number of impacts. For multiple impacts, it is necessary to select a MOV with higher surge current.

1.5 Gas Discharge Tubes (GDT)/ Spark Gap Protectors(SGP)

GDT is a component consisting of one or more discharge gaps packaged in a ceramic tube filled with inert gases. GDT's electrical performance depends on factors such as gas type, gas pressure, internal electrode structure, and manufacturing process. It can withstand surge current impacts that up to tens or even hundreds of amps. It has a very low junction capacitance, which can be used to high speed communication data lines against the damage of high voltage transients.

SPG obtains a discharge micro-gap through the distance between electrodes. The tube is filled with inert gas and it is glass sealed with a glass tube and magnesium plating wire. When the voltage across SPG increases, the nearby gas is ionized and a discharge phenomenon occurs at the micro-gap. As the voltage drop of the two poles increases, the discharge current will also increase and the ionization zone will expand. At this time, the discharge current flows to the other pole through the gas ionization zone. When the current continues to increase to a certain extent, conversion from glow discharge to arc discharge will occur in the tube, SPG changes from the high impedance state to the low impedance state and the voltage across SPG also decreases, thereby protecting the circuits. After the abnormal voltage disappears, The SPG will return to the high impedance state.

The V-I characteristics curve of GDT is shown in Figure 1.5, and the V-I characteristic curve of SPG is similar to GDT.

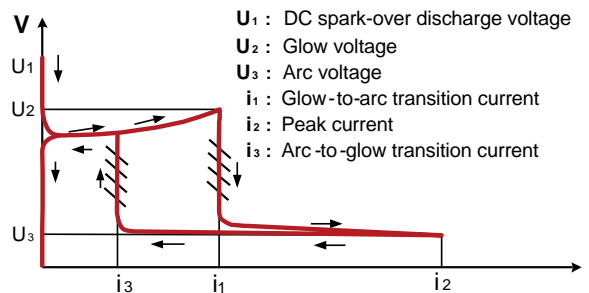

Figure 1.5 GDT's Volt-Ampere Characteristic Curve

Parameter	Definition
DC spark-over Voltage	The voltage should be applied at a rising rate that is not more than 100V/s during the measurement.
Maximum Impulse Spark-over Voltage	The voltage should be applied at a rising rate of 1000V/s during the measurement.
Nominal Impulse Discharge current	Nominal discharge current is generally applied with an 8/20μs pulse current for 10 times per 1min duration
Minimum Insulation Resistance	Minimum insulation resistance, which is measured with a certain DC voltage
Maximum Capacitance	Maximum junction capacitance

Cautions for GDT/SPG Selection

DC Breakdown Voltage: The lower limit of the DC breakdown voltage of the discharge tube should be higher than the maximum normal operating voltage of the circuit during applications, otherwise it will affect the normal operation of the circuit.

Maximum Impulse Spark-over Voltage: The Impulse Spark-over Voltage of the component should be ensured to be lower than the highest transient voltage that the protected circuit can withstand.

Nominal Discharge Current: Nominal discharge current is determined based on the impulse current that may occur in the circuit.

Follow Current Issue: The active circuit with a high voltage cannot use a gas discharge tube alone as an overvoltage protection component. To enable the discharge tube to normally extinguish the arc, the current limiting component such as a varistor or a resettable fuse can be used in series on the discharge tube where there may be a follow current.

1.6 Thyristor Surge Suppressors (TSS)

TSS is a PNPN junction four-layer structure device fabricated by the semiconductor process. Its volt-ampere characteristic is similar to thyristors (see Figure 1.6). TSS has typical switching characteristics and is generally applied in parallel circuits. Under normal working conditions, TSS is in the off state. When an abnormal overvoltage occurs in the circuit due to inductive lightning or operating overvoltage, TSS will be quickly conducted to discharge the current to protect the backend equipment from damage caused by the abnormal overvoltage. When the abnormal overvoltage disappears, TSS will return to the off state. The volt-ampere characteristics and parameters of TSS are shown in Figure 1.6.

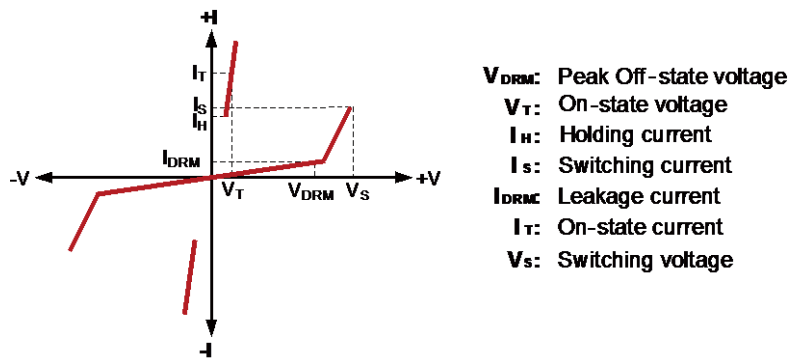

Figure 1.6 TSS's Volt-Ampere Characteristic Curve

Features

- ✦ Compare to TVS, TSS has low junction capacitance, most TSS products have capacitance values ranging from tens of pico-farads to hundreds of pico-farads.
- ✦ Variety of package types, such as axial lead, SMD, and array package (SOP-8).
- ✦ Withstanding surge current is several hundred amperes at the 8/20μs waveform.
- ✦ Small leakage current, generally less than 5μA.
- ✦ Accurate breakdown voltage, the V_{DRM} range is from 6V to 600V.

Cautions for TSS Selection

Peak off state voltage (V_{DRM}): V_{DRM} should be greater than the maximum operating voltage of the protected circuit. Otherwise, TSS will not only affect the normal operation of the protected circuit but also affect the service life of TSS.

Junction Capacitance (C_j): Communication lines should pay attention to the junction capacitance of the component that cannot affect the communication.

Follow Current Issue: TSS is a switching overvoltage protection component that has low on-state voltage V_T. In on-state conditions, if there is a high voltage applied on TSS, and the current flow through TSS is higher than I_H, TSS will continue to keep in on state even the transient interference voltage disappears. If a large abnormal overcurrent flow through TSS continuously, it will cause damage to the protected circuit or TSS itself. So TSS should not be used alone for high voltage power line protection.

1.7 Polymeric Positive Temperature Coefficient Thermistors (PPTC)

PPTC is also known as the resettable fuse. It consists of a polymer matrix and conductive carbon particles. When an abnormal overcurrent flows through PPTC, the generated heat (I^2R) will make the polymer matrix expand and the carbon particles wrapped outside the polymer matrix will separate to cut off the conductive path of PPTC, so that PPTC's resistance will rise, thereby reducing the abnormal overcurrent. When the abnormal overcurrent is eliminated, the PPTC polymeric molecules will shrink to the original shape and reconnect the carbon particles. The conductive path will recover and PPTC's resistance will return to the original low resistance state. The above process can be cycled multiple times. The biggest feature of PPTC is that it does not need to be replaced after each current fault within its rated range of application. It can be used repeatedly for overcurrent protection, which can effectively save maintenance time and cost. The resistance-temperature curve of PPTC is shown in Figure 1.7. The main parameters of PPTC are shown in Table 1.7.

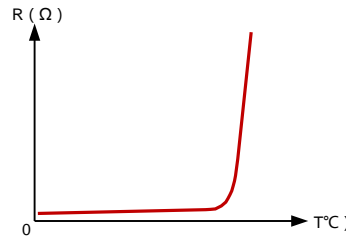

Figure 1.7 PPTC's Resistance-Temperature Curve

Table 1.7 PPTC parameters

I_{hold}	Holding current: The maximum current maintains the component without tripping in 23°C still air.
V_{max}	Maximum voltage that can be withstood
T_{trip}	The maximum duration to make PPTC trip under a specific current..
R	Zero power resistance measured at a certain temperature
I_{trip}	Trip current: minimum current at which the device will trip in 23°C still air
I_{max}	Maximum current that can be withstood
P_d	Power dissipated from device when in the tripped state in 23°C still air.
R_{1max}	Maximum resistance of device at 23°C measured one hour after tripping or reflow soldering of 260°C for 20 sec.

Cautions for PPTC Selection

Holding Current I_h : The holding current of the resettable fuse should be greater than the normal working current of the circuit, otherwise, it will affect the normal operation of the circuit.

Maximum Withstand Voltage V_{max} : it should be greater than the working voltage of the circuit, otherwise it will easily lead to the failures of PPTC.

Ambient temperature: PPTC is sensitive to ambient temperature. The holding current of PPTC should be selected according to derating in the ambient temperature. PPTC is not recommended for use when the ambient temperature is greater than 85 °C.

1.8 Negative Temperature Coefficient Thermistor (NTC & Sensor)

NTC thermistors use sintered ceramic discs made from a mixture of MnO₂, NiO, Co₂O₃, CuO₂, FeO₂. A thermistor is an electronic component whose resistance is highly dependent on temperature. NTC thermistor (NTC : Negative Temperature Coefficient) is one kind of thermistors whose resistance decreases as the ambient temperature rises (Figure 1.8.1). Therefore, NTC thermistor can be used for temperature sensing or compensation. However, NTC is not only a temperature sensing component but also an overcurrent protector to limit inrush current. The sizes of Power NTCs are usually much larger than NTC of temperature sensing type. As an inrush current limiter in the application of a power line, NTC thermistor is always connected in series with the load to be an overcurrent protector. NTC presents a higher resistance initially, and its resistance changes as the overcurrent flow through (Figure 1.8.2). NTC can absorb the energy of inrush current (Figure 1.8.33). In the meantime, NTC heats up and the resistance becomes much lower. Thus, the power loss of NTC is lower than a fixed resistor is used in the circuit.

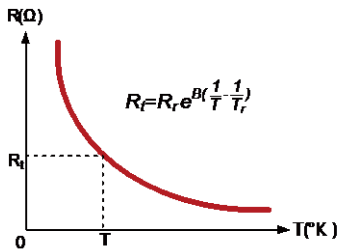

Figure 1.8 R-T curve

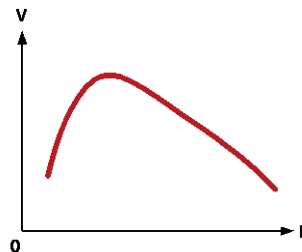

Figure 1.8 V-I curve

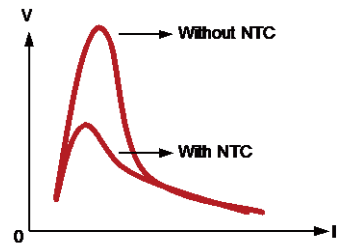

Figure 1.8.3 overcurrent with NTC or without NTC

Cautions for Temperature NTC Selection

■ **R-T Curve**

NTC thermistor is a non-linear resistor that alters its resistance characteristic with temperature. (Figure 1.8.1) If R_r is the Resistance at reference temperature T_r (K). A simple approximation for the relationship between the resistance and temperature as follows

$$R_t = R_r e^{B(\frac{1}{T} - \frac{1}{T_r})}$$

, R_t is the Resistance at temperature t(°C) → T (K)=273.15+ t

■ **Zero Power Resistance of reference temperature (R₂₅ or others)**

Usually, we choose NTC temperature sensor by two parameters (temperature and Beta Value).R₂₅ is the common reference resistance (KΩ↑) for temperature sensing application, and usually higher than KΩ.

■ **Beta Value**

$$Beta\ Value = \frac{\ln(\frac{R_{T1}}{R_{T2}})}{(\frac{1}{T1} - \frac{1}{T2})}$$

The Beta value of NTC thermistor is calculated by using resistance values of two temperatures in a given range. (ex: B(25/85): 25 to 85°C). Beta value gives the characteristic for a reference of NTC's application. Higher Beta Value can define fine scale of temperature. (Figure 1.8.4) Common Beta Value type: B(25/50), B(25/85).

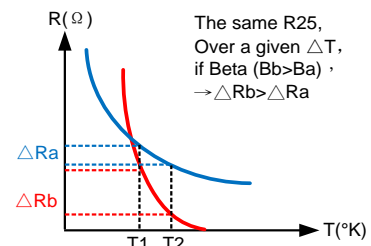

Figure 1.8.4 R-T curve of different B Value

Cautions for Power NTC Selection

■ **Zero Power Resistance at 25°C (R₂₅)**

$$R_{25} \geq \frac{V_{peak}}{I_{surge}}$$

V_{peak}=1.414Vac, I_{surge}=Max. Surge Current

For power conversion, power reverse, switch power, UPS power I_{surge} = 100 times operating current. For light filament, heater I_{surge} = 30 times operating current.

■ **Max Energy & Recommend Capacitance**

For example: Full-wave rectifier

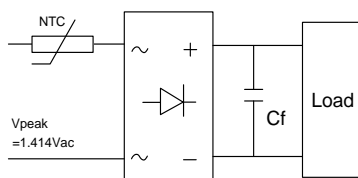

Figure 1.8.4 Full-wave Rectifier

When power NTC is applied to a power supply. The filter capacitor is charging through NTC in a relatively short time that can exhibit high inrush current. The capacitor will store an amount of energy as follows.

$$\text{Max. Energy(J)} = \frac{C(V_{peak})^2}{2}$$

The ability of the NTC to handle this energy surge can be an approximation that equal to the capacitor's energy Because the amount of energy is dependent on the voltage waveform, the recommended capacitance is defined under the condition of 1.1*220Vac=240Vac→340Vdc

■ **Max Steady State Current**

Maximum steady-state current > Actual operating current in the power loop

1.9 Comprehensive Comparison among Overvoltage Protection Components

Components

The comprehensive comparison among overvoltage protection components is shown in Figure 1.9 & Table 1.9. It can be seen from Figure 1.9 and Table 1.9 that GDT is a component with the largest peak pulse current in all kinds of overvoltage protection components. Yageo GDT single device can reach 100kA (8/20μs). The conduction of GDT is a gas ionization to form a conductive channel, which requires a large amount of energy to stimulate it. There is a process of energy accumulation. So the response time of GDT is the slowest one of all over-voltage protection components. The advantages of GDT include the low junction capacitance and the large insulation resistance, which can be used for the lightning protection of high-speed communication lines, such as coaxial cable, telephone line interface, high-definition video interface, Ethernet ports, etc.

Table 1.9 Comparison among various overvoltage protection components

Components Characteristics	Clamping Type Overvoltage Protective Components				Switching Type Overvoltage Protective Components		
	MOV	Hyper-fix TVS	TVS	ESD	GDT	SPG	TSS
Peak Pulse Current (8/20μs)	Large	Larger	Ordinary	Small	Large	Larger	Ordinary
Response Speed	Slow	Very Fast	Very Fast	Very Fast	Very Fast	Fast	Fast
Capacitance	Large	Large	Large	Small	Extra Small	Extra Small	Small
DC Breakdown Voltage Accuracy	Ordinary	Accurate	Accurate	Accurate	Ordinary	Ordinary	Accurate
Pulse Breakdown Voltage	Low	Low	Low	Low	High	High	Low

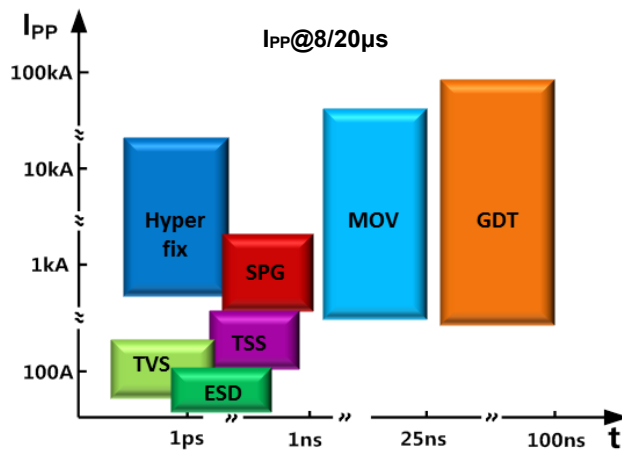

Figure 1.9 Peak Pulse Current and Response Time of Various Overvoltage Protection Components

MOV's pulse current is the second only to that of GDT and its response speed is nanosecond. It is widely used in AC power lines and the lightning protection of low frequency signal lines. Yageo's MOV pulse current can be 70kA (8/20 μ s), and the varistor voltage can reach 1800V. MOV is a polycrystalline semiconductor material made of ZnO and other metal oxides by mixing and high-temperature sintering. Its lattice structure determines its aging during application after long-term usage. GDT and SPG have large insulation resistances. At the AC input, they are often used in series with MOV in the common mode to slow down the aging of MOV.

In Figure 1.9, there is a component called hyper-fix, which is an ultra-high power TVS. It is made by overlapping several large-area chips. Its power is several tens or even hundreds of times larger than that of an ordinary TVS. It can directly replace MOV to be applied to the AC input for the primary level of lightning protection. It has advantages such as large surge current, fast response, no aging, and low clamping voltage. It is suitable for applications requiring high reliability protection devices, such as communication power, aircraft, trains, and other fields.

TSS is a surge protection component with negative resistance. Due to its special PNP junction structure design, TSS's surge current can be several times larger than that of TVS of the same size and voltage in the same chip area. TSS's capacitance is several times smaller than that of TVS of the same specification. It can be used for the surge protection of some communication lines, such as RS485, RS232, CAN bus. TSS has a high price-performance ratio and is ideal for surge protection in low-speed communication lines.

TVS diode is a component with a single PN junction or integrated by multiple PN junctions, which has the advantages of fast response speed, low clamping voltage, and high voltage accuracy. TVS is generally packaged in a chip or a through-hole package. It is small in size and is often used for the surge protection of DC power lines or low-speed communication lines.

ESD is a specially designed anti-electrostatic component. It is a TVS array with a specific layout composed of multiple diodes or TVS dies combinations. It has a shorter conducting state than that of TVS. Generally, electrostatic discharge is a nanosecond pulse whose destructive power is relatively small, so the chip area of the ESD component is also small to realize the miniaturized package. Through circuit structure designs, the ESD component has a minimum junction capacitance which can be lower than 1pF. It is suitable for the ESD protection of high-speed data lines, such as HDMI, USB3.0, IEEE1394, etc.

As the world's leading manufacturer of circuit protection components, Yageo provides customers with cost-effective circuit protection components and solutions. We provide the best circuit protection solutions for customers based on different applications.

2. Surge Protection Principle

Generally, it uses the “multi-level protection and step-by-step reduction” mode for circuit surge protection. Figure 2.1 shows the diagram of the surge protection principle.

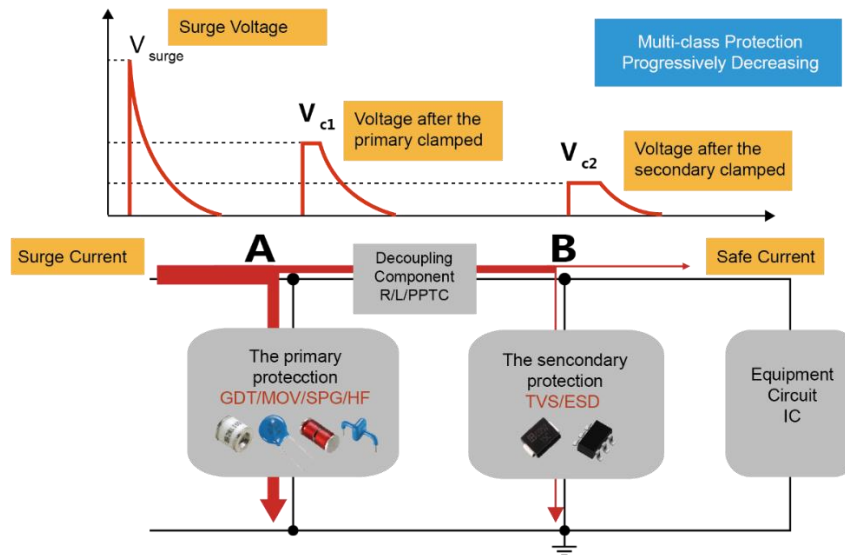

Figure 2.1 Surge protection principle

Primary Protection

Generally, the primary protection is used for the port that is most likely to introduce lightning, such as inlets of buildings, input ports of AC power supplies. Generally, different types of large surge protection devices are selected according to the application.

The primary protection of the power port generally uses a clamping-type high surge protection component. The power port is a port that provides energy to the system, which has a high voltage or a high current. If a switching protection component is selected at the power port, the voltage of the switching component is low when it is in on-state at the overvoltage, affecting the supply voltage of the system. On the other hand, the system voltage may remain in the on-state and cannot be normally cut-off. If there is a large current (such as an ampere-level current) flowing through the system for a long time, it may cause fatal damage to the circuit board and even cause fires.

For the primary clamping-type overvoltage protection device of the power port, the metal oxide varistor (MOV), the ultra-high power TVS (hyper-fix series), or the lightning protection module (SPD, surge protection device) composed of these components are generally selected.

The primary protection of the signal port generally uses the gas discharge tubes, such as GDT, SPG, TSS, and signal lightning protection modules (SPD). Of course, the low-speed signal port can also select the clamping type components for the primary protection, provided that the junction capacitance of the clamping type component will not affect the normal operation of communication lines.

Secondary Protection

The secondary protection is similar to the primary protection. Generally, TVS and ESD with high response speeds and low clamping voltage are selected.

Decoupling Component

Since the primary protection and the secondary protection adopt different types of overvoltage protection components, they have different breakdown voltages and different response times, it is necessary to add decoupling components between

the two-stage overvoltage protection devices to ensure that the overvoltage protection components in primary and secondary protection can work together. The decoupling component requires a certain impedance so as to function as a decoupling.

The working principle of the decoupling component is shown in Figure 2.1. Generally, the secondary overvoltage protection device adopts a small surge current and low-voltage component with a fast response speed. The component needs to be turned on first when the surge voltage is impacted. The decoupling component has a certain internal resistance. When there is a large surge current, the voltage before the decoupling component (point A in Figure 2.1) is raised above the breakdown voltage of the overvoltage component for primary protection. The primary protection component is turned on to discharge the surge current, thus sharing the pressure of the secondary protection component. If no decoupling component is added between the two-stage overvoltage protection components, the secondary protection components will always be in the on-state, which will cause damage when the surge current exceeds the capability of the secondary protection components.

The selection of the decoupling component should be selected according to the working current of the circuits. For example, some signal circuits have small operating currents. In the case of ensuring the normal communication, a power-type resistor or a resettable fuse (PPTC) can be selected. The decoupling resistance is generally selected within 10Ω. From the perspective of the surge protection, the larger the decoupling resistance, the better the protection, but it should not be too large. Otherwise, it will affect the normal working current of the circuits. Engineers should consider these factors comprehensively during the circuit design.

For some low-frequency circuits with large input current, inductors can be used for decoupling. The calculation formula of the inductor impedance is $Z=2\pi fL$. After the decoupling impedance value is determined, the magnitude of the inductance can be calculated from the formula.

3. Typical Application Cases

3.1 Power System Typical Application Cases

3.1.1 AC Power Port Surge Protection

	<p>The scheme adds a MOV between L and N for the differential mode protection, which is suitable for low power supplies. According to the application and test requirements, please consult our technical staff to select the specific model.</p> <p>Solution : MOV, NT/SP</p> <p>Testing Standard : IEC61000-4-5 , GB/T 17626.5 , UL1449</p>
	<p>The common mode protection by a MOV is used in series with a GDT to ground to slow down the aging of the MOV. This scheme is suitable for medium and large power supplies. According to the application and test requirements, please consult our technical staff to select the specific model.</p> <p>Solution : MOV, GDT, NT/SP</p> <p>Testing Standard : IEC61000-4-5 , GB/T 17626.5 , UL1449</p>

3.1.2 Protection of Other Portions of the Power System

<p>Common Mode Choke Protection: BK12001502/BK1201502-M/BK22001502/BK22001502-M/BK32001502/BK32001502-M</p> <p>Absorption Circuit Protection: P6KE200A/SMBJ170A</p> <p>Output Surge Protection: TVS</p> <p>Bridge Rectifier Secondary Residual Voltage: P6KE440CA/SMBJ400CA</p> <p>Inrush current protection NTC: NT/SP</p> <p>Test standard: IEC61000-4-5, GB/T17626.5</p>

3.1.3 DC Power Port Surge Protection

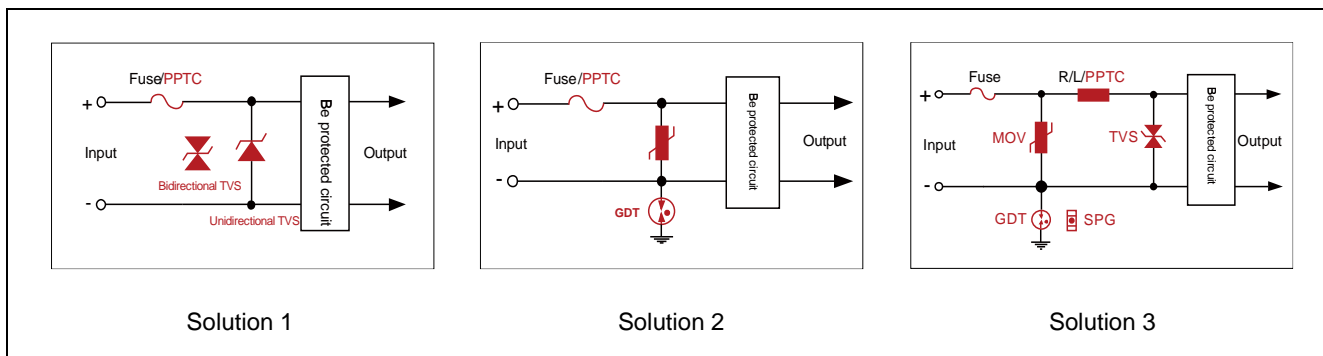

Working voltage /PPTC	Solution 1	Solution 2	Solution 3
DC5V	TVS: SMBJ5.0A/CA 1.0SMB6.8A/CA SMCJ5.0A/CA	Not applicable	MOV: 820KD14 GDT: 4532-091-LF SPG: BK13001502/ BK1301502-M TVS: SMBJ5.0CA
DC12V	TVS: SMBJ18A/CA 1.0SMB18A/CA SMCJ18A/CA	MOV: 180KD10 GDT: B32-150-LF SPG: BK33001502/ BK33001502-M	MOV: 820KD14 GDT: 4532-091-LF SPG: BK13001502/ BK1301502-M TVS: SMBJ18CA
DC24V	TVS : SMBJ28A/CA 1.0SMB33A/CA SMCJ28A/CA	MOV: 330KD10 GDT: B32-150-LF SPG: BK33001502/ BK33001502-M	GDT: 4532-091-LF SPG: BK13001502/ BK1301502-M TVS: SMBJ28CA
DC48V	TVS : SMBJ58A/CA 1.0SMB68A/CA SMCJ58A	MOV: 820KD10 GDT: B32-150-LF SPG: BK33001502/ BK33001502-M	MOV: 820KD14 GDT: 4532-091-LF SPG: BK13001502/ BK1301502-M TVS: SMBJ58CA
PPTC	SMD1812/BK60 ¹	SMD1812/BK60 ¹	SMD1812/BK60 ¹

Note1: The specific model of PPTC can consult our technicians according to the actual application.

3.2 Communication Interfaces Protection

3.2.1 100M/1000M RJ45 Port (Ethernet) Protection

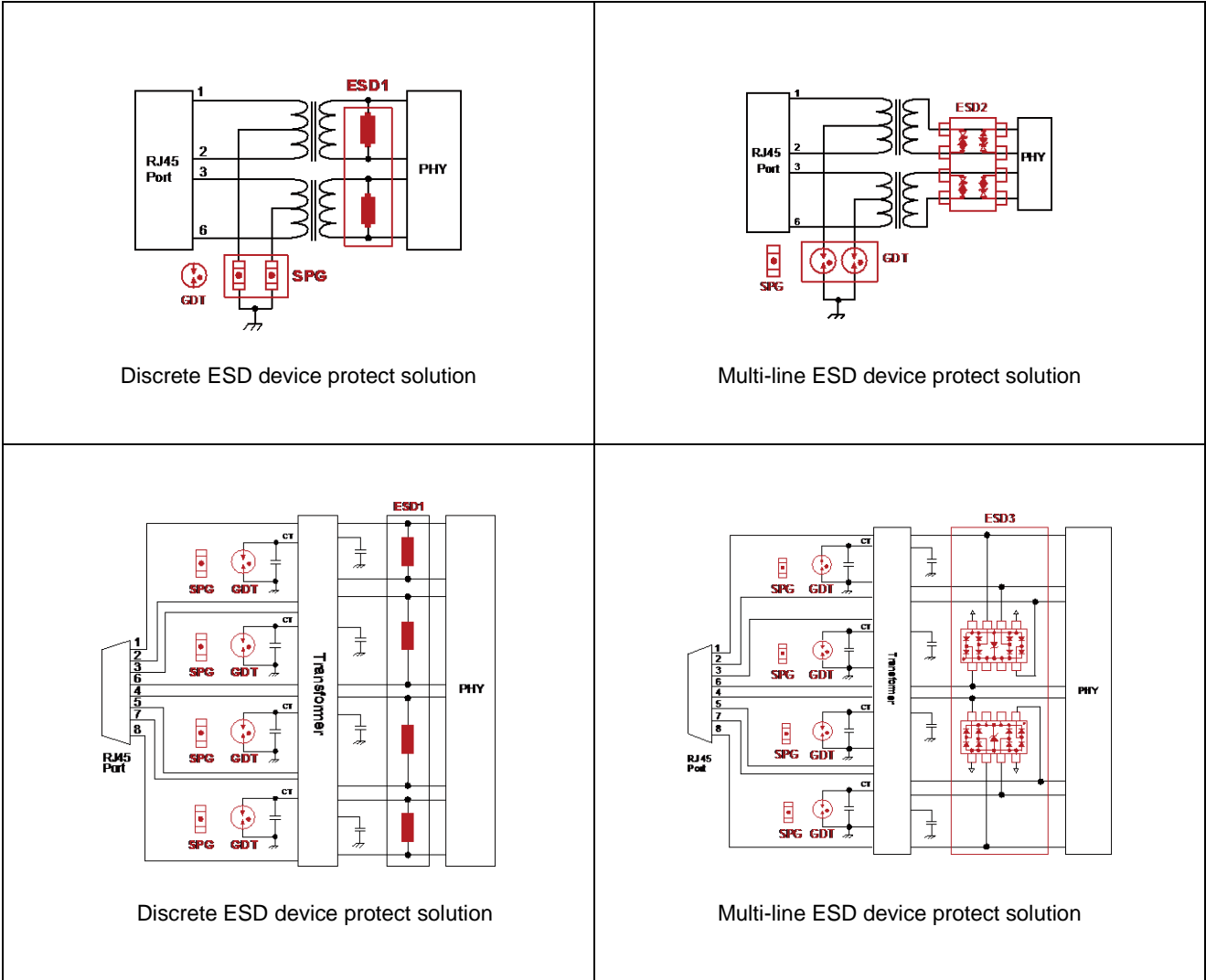

GDT or SPG are used for the common mode protection for the Ethernet port on the primary side of the isolating transformer. Discrete or Integrated multi-line ESD devices are used for differential mode protection on the secondary side of the isolation transformer, P/Ns below are popular models.

GDT: [2RL075L/M-5](#), [2RM075L/M-8](#), [4532-075/091-LF](#)

SPG: [BK13000702/BK1300702-M/BK23000702/BK23000702-M/BK33000702/BK33000702-M](#)

ESD1: [UDD32C03/05L01](#)

ESD2: [UFS08A2.8L04](#)

ESD3: [UES08A03L05](#)

Reference test standards: IEC61000-4-2, GB/T 17626.2, IEC61000-4-5, GB/T17626.5

3.2.2 100M /1000M PoE (Power on Ethernet) Protection

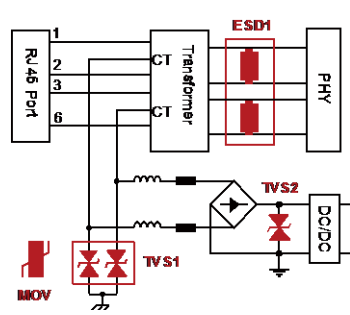
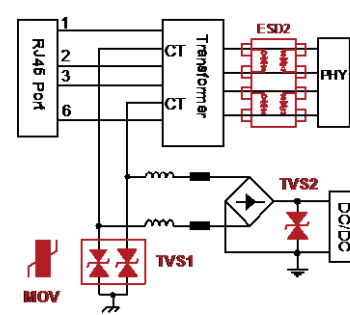
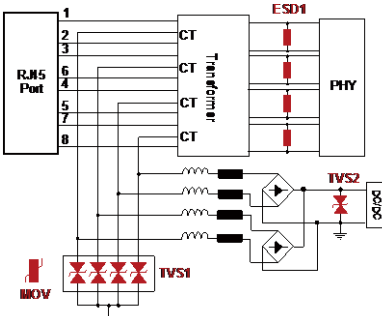
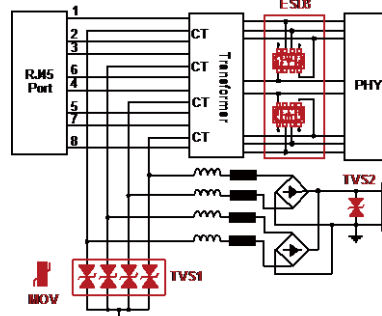
 <p>Discrete ESD device protect solution (100M)</p>	 <p>Integrated multi-line ESD device protect solution(100M)</p>
 <p>Discrete ESD device protect solution (1000M)</p>	 <p>Integrated multi-line ESD device protect solution(1000M)</p>

The primary side of the Ethernet with PoE power supply needs to be clamped type protection device, such as TVS or MOV for protection. The secondary side generally uses ESD for the absorption of differential mode surge interference, and the discrete device or integrated device can be flexibly selected according to the design requirements, P/Ns below are popular models.

MOV: 101KD14 **TVS1:** 5.0SMDJ58CA **TVS2:** SMCJ58CA / SMDJ58CA
ESD1: UDD32C03/05L01 **ESD2:** UFS08A2.8L04 **ESD2:** UES08A03L05
Reference test standards: IEC61000-4-2, GB/T 17626.2, IEC61000-4-5, GB/T17626.5

3.2.3 Antenna (RF port) Protection

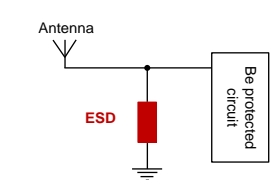
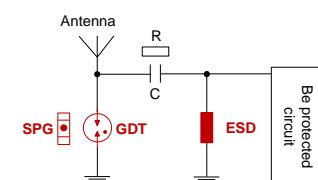
 <p>ESD protection</p>	 <p>Surge protection</p>
---	--

For ESD protection, ultra-low capacitance ESD components are recommended. Two-stage protection solution can be used for some high protection level require circuit.

GDT: 2RL075L/M-5, 2RM075L/M-8 **SPG:** BK13001502/BK1301502-M
ESD: UAQ02C05L01, UBD32C05L01, UAD8C05L01, UAD52A05L01
Reference test standards: IEC61000-4-2, GB/T 17626.2, IEC61000-4-5, GB/T17626.5

3.2.4 USB2.0 Port ESD Protection

Circuit connection diagram

SOT-143 packaged device can be used for one USB2.0 port data line and power line ESD protection. SOT23-6L packaged device can simultaneously protect two USB2.0 port data lines and power lines. Discrete ESD protection device also can be chosen for one or two USB2.0 ports protection.

Device selection:
ESD1: [UET14A05L03-BK](#)
ESD2: [UDD32C03/05L01](#) / [UAD8C05L01](#)
ESD3: [UDT26A05L05-LC1](#), [UCT26A05L05-HP1](#)
PPTC: [SMD1812 BXXXTF](#)

Reference test standards:
 IEC61000-4-5, GB/T17626.5, ISO10605, GB/T 19951

3.2.5 USB3.0 Port ESD Protection

The data lines are protected with ultra-low capacitance ESD devices. The power line is protected with PPTC and a larger power ESD device. P/Ns below are popular models.

ESD1: [SDD32CXXL01](#)/[SDD32AXXL01](#)/[SHD8C4.5L01](#)/[SBD52C05L01](#)/[SDD52C05L01](#)/[SFD52A05/07L01](#)

ESD2: [UAQ02C05L01-R0.5](#)/[UDD32C05L01](#)/[UAD8C05L01](#)/[UAD52A05L01](#)

ESD4: [UET14A05L03-BK](#)/[UDT14A05L03](#)

ESD5: [UBQ10A05L04HI](#)/[UBQ10A03L04](#)/[UBQ10A05L04-LV](#)/ [UAD20A05L04-R0.4](#)

ESD6: [UDT26A05L05-LC1](#)

PPTC: [SMD1812BxxxTF/x](#)

Test standard : IEC61000-4-2, GB/T17626.2

3.2.6 USB Type-C ESD Protection

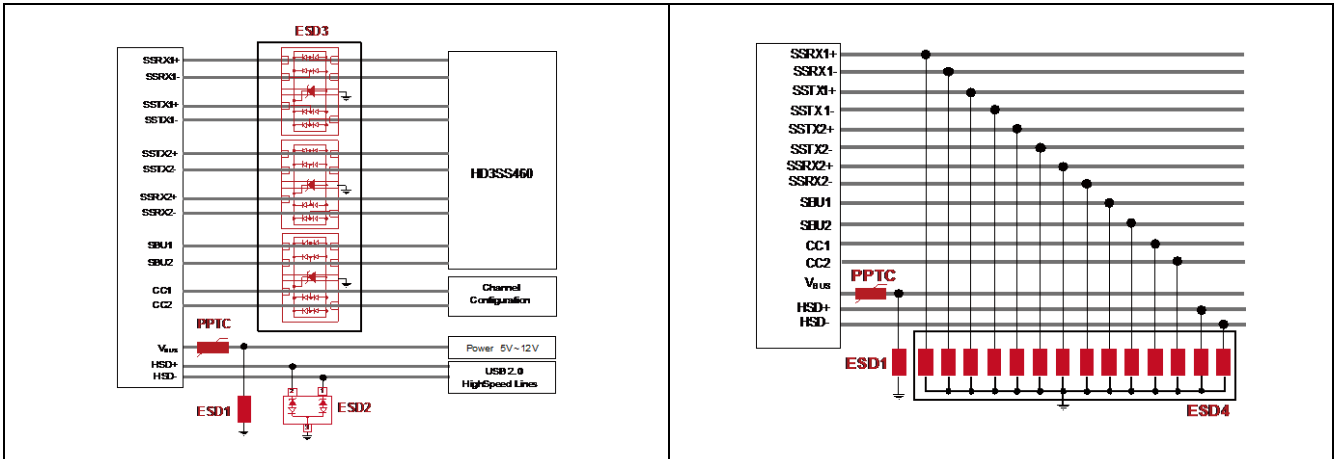

The USB3.1 interface still uses two pairs of transceiver differential lines, but the rate is increased up to 10Gbps, the rising edge of the signal is 0.02~0.03ns, the protection device junction capacitance is recommended to be less than 0.4pF. The figure above shows the protection scheme of the USB 3.1 protocol using the most popular Type C physical interface. P/Ns below are popular models.

- PPTC:** [SMD1812BxxxTF/x](#) **ESD1:** [SDD32CXXL01](#) / [SFD52A05/07L01](#) **ESD2:** [UBT23A05L02](#)
ESD3: [UBQ10A05L04HI](#)/[UBQ10A03L04](#)/[UBQ10A05L04-LV](#)/[UAD20A05L04-R0.4](#)
ESD4: [UAQ02C05L01-R0.5](#)/[UAD8C05L01](#)
Test standard: IEC61000-4-2, GB/T17626.2

3.2.7 HDMI Port ESD Protection



Ultra-low capacitance ESD products with different package types can be selected for HDMI port protection. P/Ns below are popular models.

- ESD1:** [UAD8C05L01](#)
[UAD8C05L01-R0.4](#)
[UAQ02C05L01-R0.5](#)
ESD2: [UAD20C05L04-R0.4](#)
ESD3: [UBQ10A03L04](#), [UBQ10A05L04HI](#), [UBQ10A05L04-LV](#), [UBQ10A05L04-R0.4](#)

3.2.8 Display Port ESD Protection

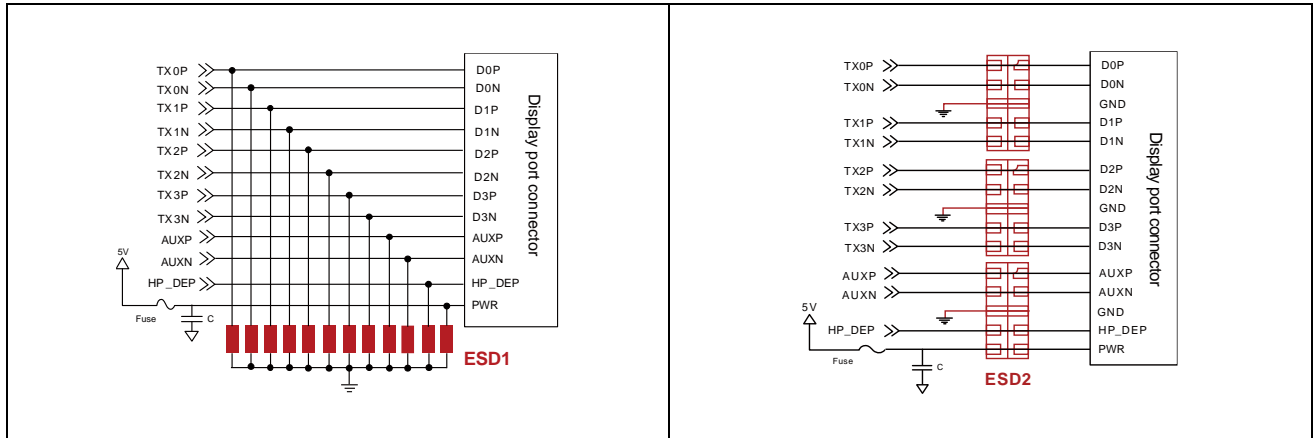

Ultra-low capacitance ESD products with different package types can be selected for display port protection. P/Ns below are popular models.

- ESD1: [UAD8C05L01](#)
[UAD8C05L01-R0.4](#)
[UAQ02C05L01-R0.5](#)
- ESD2: [UBQ10A03L04](#)
[UBQ10A05L04HI](#)
[UBQ10A05L04-LV](#)
[UBQ10A05L04-R0.4](#)

3.2.9 VGA Port ESD Protection

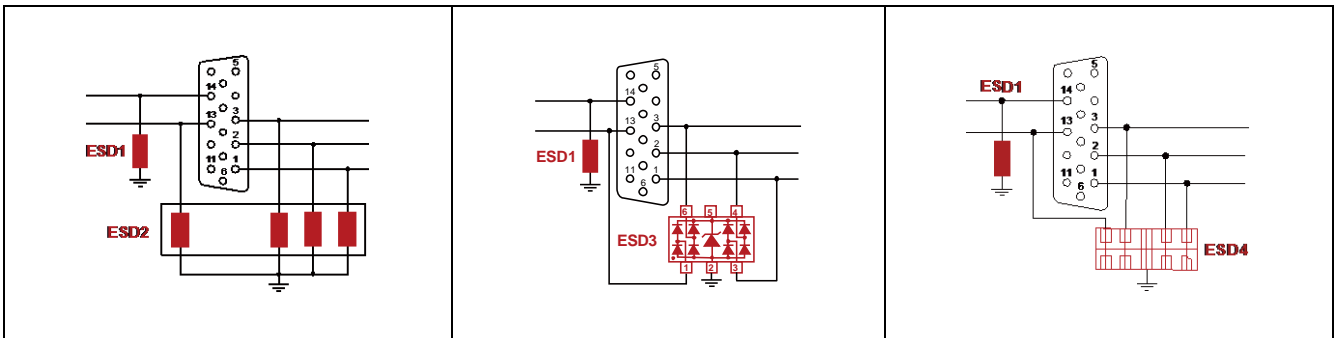

A single-line ESD device is used to protect the field synchronization signal line, single line or multi-line ESD device can be chosen to protect the synchronization line and RGB signal lines of VGA port.

- ESD1: [SBD52C05L01](#) / [SDD52C05L01](#)
- ESD2: [UAQ02C05L01](#)/[UAD8C05L01](#)/[UAD52A05L01](#) /[UDD32C05L01](#)
- ESD3: [UCT26A05L05-HP1](#) / [UDT26A05L05-LC1](#)
- ESD4: [UBQ10A05L04HI](#)/[UBQ10A03L04](#)/[UBQ10A05L04-LV](#)/[UBQ10A05L04-R0.4](#)

3.2.10 DVI Port ESD Protection

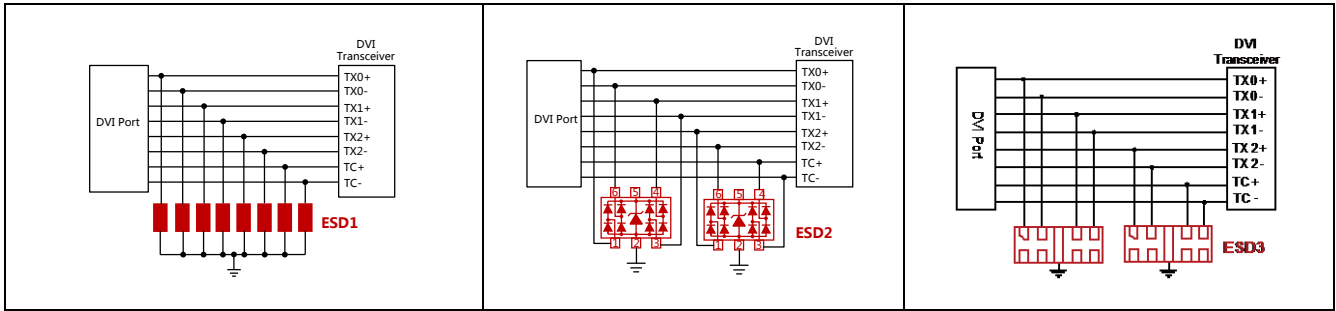

Ultra-low capacitance ESD products with different package types can be selected for DVI port protection. P/Ns below are popular models.

ESD1: [UBD32C05L01](#), [UAD8C05L01](#), [UAD8A05L01](#), [UAQ02C05L01-R0.5](#), [UAD52A05L01](#), [UAD03C05L01](#)

ESD2: [UCT26A05L05-HP1](#), [UDT26A05L05-LC1](#)

ESD3: [UAD20C05L04-R0.4](#), [UBQ10A05L04HI](#), [UBQ10A05L04-LV](#)

Reference test standards: GB/T17626.2, IEC61000-4-2

3.2.11 LVDS ESD Protection

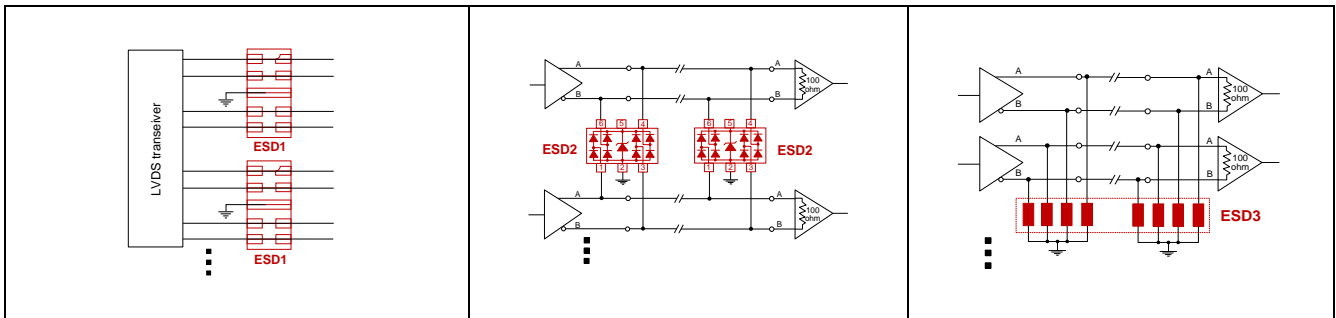

ESD1: [UAD20C05L04-R0.4](#), [UBQ10A05L04HI](#), [UBQ10A05L04-LV](#)

ESD2: [UCT26A05L05-HP1](#), [UDT26A05L05-LC1](#)

ESD3: [UAQ02C05L01](#), [UBD32C05L01](#), [UAD8C05L01](#), [UAD52A05L01](#)

Reference test standards: IEC61000-4-2, GB/T17626.2

3.2.12 SIM Card ESD Protection

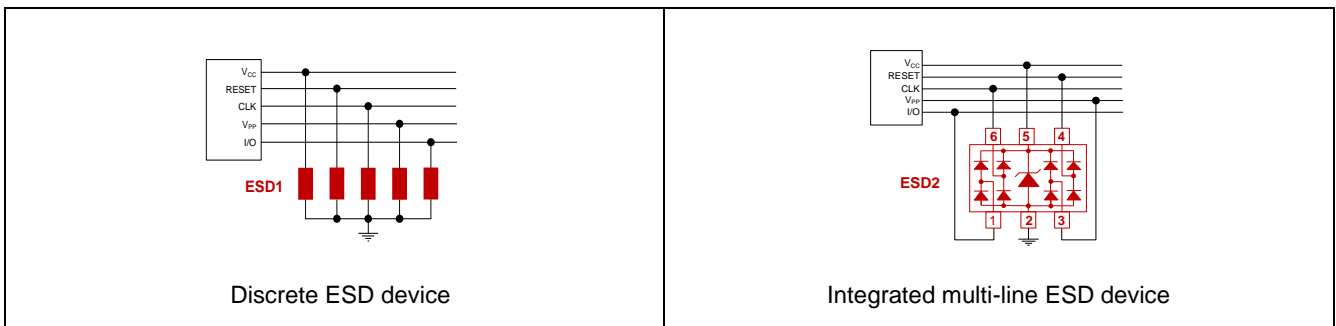

ESD1: [UAQ02C05L01](#), [UBD32C05L01](#), [UAD8C05L01](#), [UAD52A05L01](#)

ESD2: [UCT26A05L05-HP1](#), [UDT26A05L05-LC1](#)

Reference test standards: IEC61000-4-5, GB/T17626.5, ISO10605, GB/T 19951

3.2.13 SD Card ESD Protection

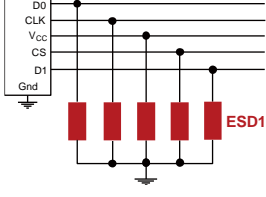
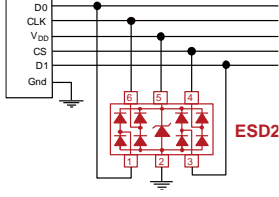
ESD1: [UBD32C05L01](#), [UAD8C05L01](#), [UAD8A05L01](#), [UAD52A05L01](#), [UAQ02C05L01-R0.5](#)
ESD2: [UCT26A05L05-HP1](#), [UDT26A05L05-LC1](#)
Reference test standards: IEC61000-4-2, GB/T17626.2

3.2.14 SCART Card ESD Protection

ESD1: [UAD33A05L06](#)
ESD2: [UDD32C12/15L01](#)
ESD3: [UBD32C05L01](#), [UAD8C05L01](#), [UAD8A05L01](#), [UAD52A05L01](#), [UAQ02C05L01-R0.5](#)
Reference test standards: GB/T17626.2, IEC61000-4-2

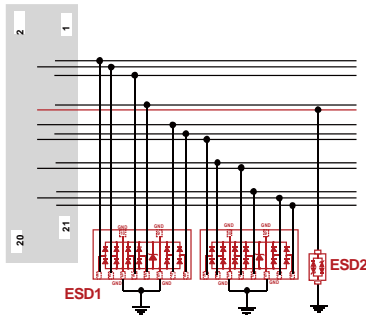
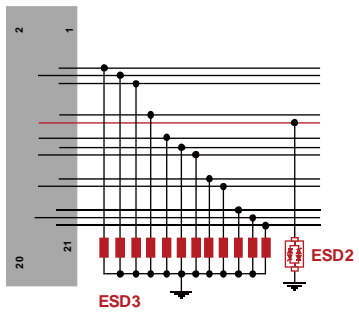
3.2.15 RJ11 Port Surge Protection

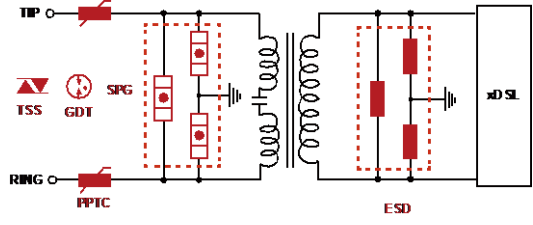

The primary side uses SPG or SPG or GDT for differential and common mode protection, and the PPTC is connected in series to protect the power line for overcurrent and power line bonding tests. The secondary side uses the low capacitance and high surge capability ESD for secondary protection.

PPTC: BK250/BK600 **SPG:** BK12001502/BK12001502-M **GDT:** 2RL350L/M-5, 2RM350L/M-8
TSS: P3100SC **ESD:** UDD32CXXL01
Test standard: IEC61000-4-2, GB/T 17626.2, IEC61000-4-5, GB/T17626.5

3.2.16 CAN Bus Protection

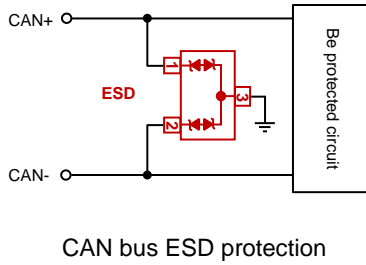

SOT-23 package devices are used for CAN bus protection, SDT23C24L02 is used for low speed CAN bus, and LEB23C24L02 can be used for high speed CAN bus.

Device selection:

ESD: [SDT23C24L02](#), [LBT23C24L02](#)

ESD: [SDT23C24L02-AT](#), [LBT23C24L02-AT\(Automotive\)](#)

Reference test standards:

IEC61000-4-5, GB/T17626.5, ISO10605, GB/T 19951

3.2.17 LIN Bus ESD Protection

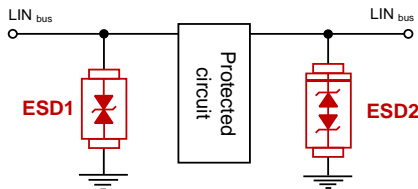

This solution is mainly used in automotive protection. The following two models can be selected.

ESD1: [SDD32C24L01-AT](#)

ESD2: [LBD32C1524L01\(High speed\)](#)

Reference test standards:

IEC61000-4-5, GB/T17626.5

ISO10605, GB/T 19951

3.2.18 BNC Port Protection

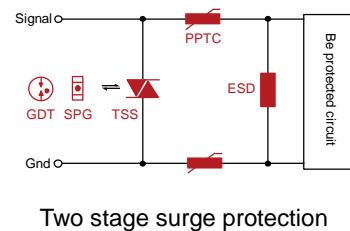
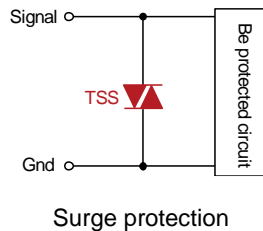
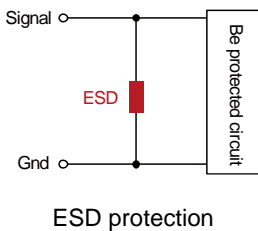

For two-stage surge protection, TSS or SPG or GDT can be used for the primary protection device, PPTC is used as the decoupling device, ESD is used as the secondary protection device. P/Ns below are popular models.

TSS: [P0080SX \(X: A/B/C\)](#) **PPTC:** [SMD 1812](#) **ESD:** [UDD32C05L01](#)

Reference test standards: IEC61000-4-2, GB/T 17626.2, IEC61000-4-5, GB/T17626.5

3.2.19 RS485 Port Protection

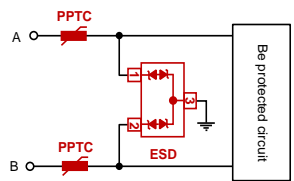
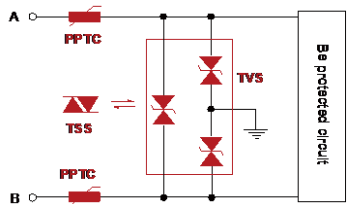
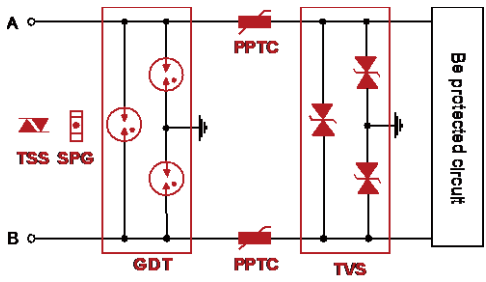
 <p style="text-align: center;">ESD protection</p>	<p>A dedicated RS485 ESD protection device is used for common mode and differential mode protection. This device has an asymmetric 7V and 12V operating voltage.</p> <p>ESD: SDT23C712L02 PPTC: SMD1812B010TF/ BK250-110</p> <p>Reference test standards: IEC61000-4-2,GB/T17626.2</p>
 <p style="text-align: center;">Low surge protection</p>	<p>Using power TVS or TSS for RS485 port surge protection can gain high protection level.</p> <p>TVS: SMBJ6.5CA TSS: P0080SB PPTC: BK250-110</p> <p>Reference test standards: IEC61000-4-2,GB/T17626.2 IEC61000-4-5,GB/T17626.5</p>
 <p style="text-align: center;">Two stage protect solution for high surge</p>	<p>The first stage common mode and differential mode protection devices can choose SPG, TSS, or GDT, the secondary common mode and, differential mode protection devices can choose TVS. Two-stage protection solution can gain high protection level and low clamping voltage at the same time.</p> <p>GDT: 2RM090M-5 SPG: BK13001502/BK1301502-M PPTC: SMD1812B010TF/ BK250-110 TVS: SMAJ5.0CA</p> <p>Reference test standards: IEC61000-4-2,GB/T17626.2 IEC61000-4-5,GB/T17626.5</p>

3.2.20 YCRCB/YPRPB Port ESD Protection

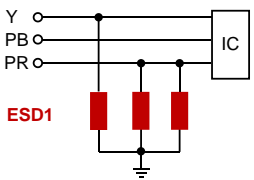
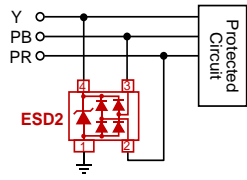
 <p style="text-align: center;">Discrete ESD Device</p>	 <p style="text-align: center;">Integrated multi-line ESD Device</p>
<p>ESD1: UBD32C05L01, UAD8C05L01, UAD8A05L01, UAD52A05L01, UAQ02C05L01-R0.5 ESD2: UET14A05L03-BK</p> <p>Reference test standards: GB/T17626.2, IEC61000-4-2</p>	

3.2.21 S-Video ESD Protection

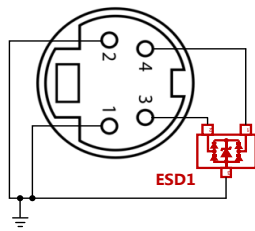
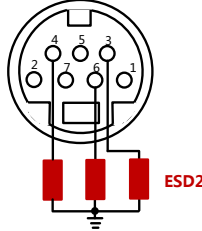
 <p>Integrated multi-line ESD device</p>	 <p>Discrete ESD device</p>
<p>ESD1: <u>UAT52A05L02/UBT23A05L02</u></p> <p>ESD2: <u>UBD32C05L01, UAD8C05L01, UAD8A05L01, UAQ02C05L01-R0.5, UAD52A05L01, UAD03C05L01</u></p> <p>Reference test standards: GB/T17626.2, IEC61000-4-2</p>	

3.2.22 Headphone Interface ESD Protection

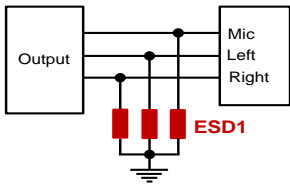
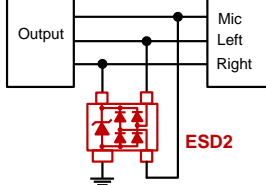
 <p>Discrete ESD device</p>	 <p>Integrated multi-line ESD device</p>
<p>ESD1: <u>SDD32C05L01, SBD52C05L01, SDD52C05L01, SED52C05L01, LAD52C05L01, LAD8C05L01, LAD92C5.0L01</u></p> <p>ESD2: <u>UET14A05L03-BK</u></p> <p>Reference test standards: GB/T17626.2, IEC61000-4-2</p>	

3.2.23 Keys/buttons ESD Protection

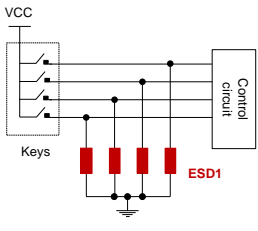
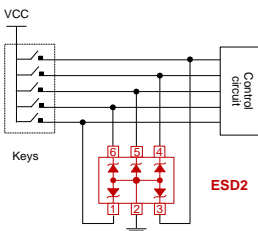
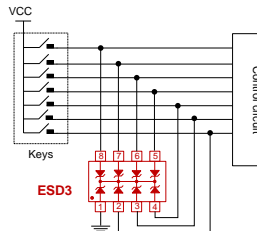
		
<p>ESD1: <u>SBD52C05L01, SJD12A(C)XXL01, SED52C05L01, SDD8A12L01</u></p> <p>ESD2: <u>SAT36A05L05</u></p> <p>ESD3: <u>SCS08C05L07/SCS08C12L07/SCS08C15L07/SCS08C24L07</u></p> <p>Reference test standards: IEC61000-4-2, GB/T17626.2</p>		

3.2.24 I/O Port ESD Protection

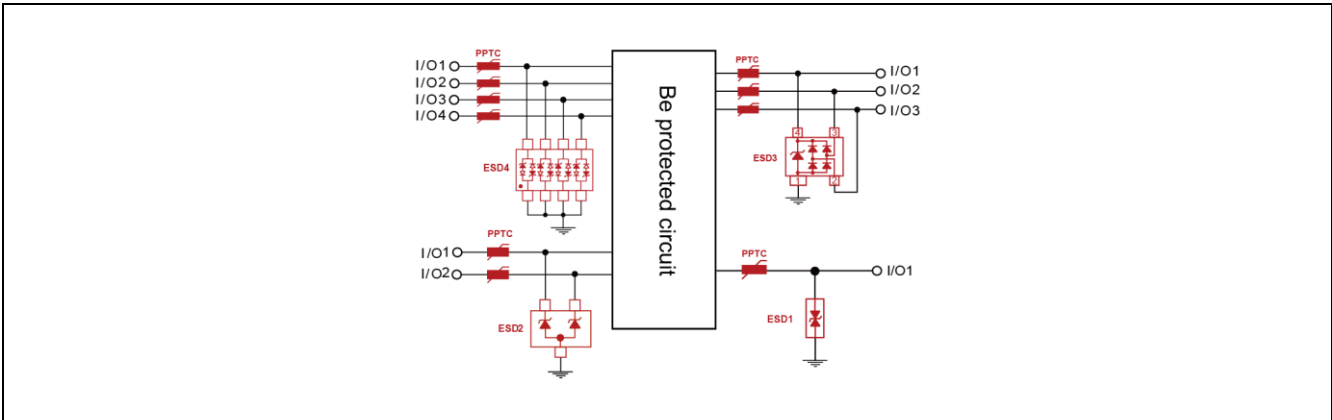

Different number of I/O lines can choose different package ESD device. Above are some typical applications, other needs can consult our technical support engineer.

Device selection:

PPTC: [PPTC](#)

ESD1: [SBD52C05L01](#), [SJD12A\(C\)XXL01](#), [SED52C05L01](#)

ESD2: [SDT23C05L02](#)/[SDT23C12L02](#)/[SDT23C15L02](#)/[SDT23C24L02](#)

[SET23A03L02](#)/[SET23A05L02](#)/[SET23A12L02](#)/[SET23A15L02](#)/[SET23A24L02](#)/[SET23A36L02](#)

ESD3: [UDT14A05L03](#)

ESD4: [LES08C05L04](#)/[LES08C12L04](#)/[LES08C15L04](#)/[LES08C24L04](#)

Reference test standards: IEC61000-4-2, GB/T17626.2

3.2.25 RS232 Port ESD Protection

	<p>PPTC: SMD1812B010TF, BK250-110-SZ</p> <p>TVS: SMBJ6.5CA, SMBJ12CA</p> <p>TSS: P008SA/B/C, B6SA</p> <p>Reference test standards IEC61000-4-2, GB/T17626.2</p>
--	---

3.2.26 AV Terminal ESD Protection





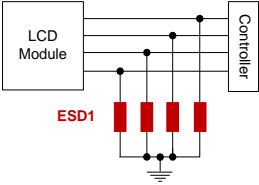
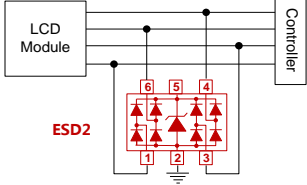

<p>ESD1: UBD32C05L01, UAD8C05L01, UAQ02C05L01-R0.5, UAD52A05L01</p> <p>ESD2: UET14A05L03-BK</p> <p>Reference test standards: IEC61000-4-2, GB/T17626.2</p>	

3.2.27 LCD Module ESD Protection



 <p>Discrete ESD device</p>	 <p>Integrated multi-line ESD device</p>
<p>ESD1: UAD8C05L01, UAD03C05L01 ESD2: UCT26A05L05-HP1, UDT26A05L05-LC1 Reference test standards: IEC61000-4-2, GB/T17626.2</p>	

4. Yageo TVS Products Line









Automotive Products (AEC-Q101 Qualified)

Series	Polarity	Minimum Peak Pulse Power@10/1000µs P _{PPM} (W)	Figures	Package	Reverse Stand-Off Voltage V _{RWM} (V)	Maximum Clamping Voltage @I _{PP} V _C (V)	Peak Pulse Current I _{PP} (A)
SMAJ-AT	Uni//Bi	400		SMA/DO-214AC	5.0~440.0	9.2~713.0	43.5~0.6
P4SMA-AT	Uni//Bi				5.80~467.00	10.5~760.0	39.0~0.5
P4KE-AT	Uni//Bi			DO-204AL/DO-41	5.80~467.00	10.5~760.0	39.0~0.52
SMBJ-AT	Uni//Bi	600		SMB/DO-214AA	5.0~440.0	9.2~713.0	65.3~0.9
P6SMB-AT	Uni//Bi				5.80~467.00	10.5~760.0	58.1~0.8
P6KE-AT	Uni//Bi			DO-204AC/DO-15	5.80~512.00	10.5~828.0	58.1~0.75
SMCJ-AT	Uni//Bi	1500		SMC/DO-214AB	5.0~440.0	9.2~713.0	163.0~2.1
1.5SMC-AT	Uni//Bi				5.80~467.00	10.5~760.0	144.8~2.0
1.5KE-AT	Uni//Bi			DO-201	5.80~467.00	10.5~760.0	144.8~2.0
SMDJ-AT	Uni//Bi	3000		SMC/DO-214AB	5.0~220.0	9.2~356.0	326.1~8.4
3KP-AT	Uni//Bi			P600	5.0~220.0	9.2~356.0	326.1~8.4
5.0SMDJ-AT	Uni//Bi	5000		SMC/DO-214AB	11.0~170.0	18.2~275.0	275.00~18.2
5KP-AT	Uni//Bi			P600	5.0~250.0	9.2~425.0	554.3~12.0
ATS-2CF	Uni//Bi	10000		P600	22~40	35.5~64.5	287~155

Other TVS Products (High power)











Series	Polarity	Package	I _{PP} (KA)	V _C (V) @I _{PP}	V _{AC}	V _{DC}	V _{BR MIN.} (V)
HF-L	HFA-XXXL		3	80~868	8.5V~770V	12.8~1100	14~1200
	HFB-XXXL		6	80~625	8.5V~310V	12.8~430	14~440
	HFC-XXXL		10	80~625	8.5V~310V	12.8~430	14~440
	HFD-XXXL		16	80~330	8.5V~150V	12.8~200	14~222
HF-C	HFA-XXXC		3	80~868	8.5V~385V	12.8~500	14~558
	HFB-XXXC		6	80~520	8.5V~275V	12.8~380	14~401
	HFC-XXXC		10	80~210	8.5V~145V	12.8~190	14~200
HF-S	HFA-XXXS		3	80~868	8.5V~385V	12.8~500	14~558
	HFB-XXXS		6	80~520	8.5V~275V	12.8~380	14~401
	HFC-XXXS		10	80~290	8.5V~145V	12.8~190	14~200

Other TVS Products





Series	Polarity	Minimum Peak Pulse Power@10/1000µs P _{PPM} (W)	Figures	Package	Reverse Stand-Off Voltage V _{RWM} (V)	Maximum Clamping Voltage @I _{PP} V _C (V)	Peak Pulse Current I _{PP} (A)	
SMAJ	Uni/Bi	400		SMA/DO-214AC	5.0~440.0	9.2~713.0	43.5~0.6	
P4SMA	Uni/Bi				5.80~510.00	10.5~828.0	39.0~0.48	
P4KE	Uni/Bi				DO-204AL/DO-41	5.80~510.00	10.5~828.0	39.0~0.48
SA	Uni/Bi	500		DO-204AC/DO-15	5.0~220.0	9.2~356.0	55.4~1.4	
SAC(50pF)	Uni					5.0~50.0	10.0~88.0	44.0~5.8
P6KE	Uni/Bi	600		SMB/DO-214AA	5.80~512.00	10.5~828.0	58.1~0.75	
SMBJ	Uni/Bi					5.0~440.0	9.2~713.0	65.3~0.9
P6SMB	Uni/Bi					5.80~510.00	10.5~828.0	58.1~0.75
1.0SMB	Uni/Bi	1000			5.8~58.1	10.5~92.0	96.8~11.0	
SMCJ	Uni/Bi	1500		SMC/DO-214AB	5.0~440.0	9.2~713.0	163.0~2.1	
1.5SMC	Uni/Bi					5.80~510.00	10.5~828.0	144.8~1.8
1.5KE	Uni/Bi				DO-201	5.80~510.00	10.5~760.0	144.8~1.8
LCE(100pF)	Uni					6.5~28.0	11.2~45.5	100~33
SMDJ	Uni/Bi	3000		SMC/DO-214AB	5.0~220.0	9.2~356.0	326.1~8.4	
3KP	Uni/Bi				P600	5.0~220.0	9.2~356.0	326.1~8.4
5.0SMDJ	Uni/Bi	5000		SMC/DO-214AB	11.0~170.0	18.2~275.0	275.00~18.2	
5KP	Uni/Bi				P600	5.0~250.0	9.2~425.0	554.3~12.0
15KPA	Uni/Bi	15000		17.0~280.0		29.3~454.5	515.4~33.2	
20KPA	Uni/Bi	20000		20.0~300.0		36.8~483.0	548.9~41.8	
30KPA	Uni/Bi	30000		28.0~288.0		50.0~469.9	606.0~64.5	

5. Yageo MOV Products Line

105°C MOV (KD Series)

Series	Figures	Breakdown Voltage	Maximum Operating Voltage		Maximum Single Peak Pulse Current		Maximum Energy (10/1000µs)	
		V _{1mA} (V)	V _{AC} (V)	V _{DC} (V)	Standard type I(A)	High Energy type I(A)	Standard type (J)	High Energy type (J)
05D		18~68	11~40	14~56	100	250	0.4~1.6	0.6~2.2
		82~750	50~460	65~615	400	800	2.5~22.4	4.0~32
07D		18~68	11~40	14~56	250	500	0.9~3.6	2.0~7.0
		82~820	50~510	65~670	1200	1750	5.0~67.2	10.0~70.0
10D		18~68	11~40	14~56	500	1000	2.1~8.2	3.0~15.0
		82~1100	50~680	65~895	2500	3500	12.0~115.0	17.0~155.0
14D		18~68	11~40	14~56	1000	2000	4.0~14.0	7.0~24.0
		82~1800	50~1100	65~1465	4500	6000	22.0~250	27.0~335
20D		18~68	11~40	14~56	2000	3000	11~46	13~49
		82~1800	50~1100	65~1465	6500	10000	38~625	56~990
25D		18~68	11~40	14~56	4500		20~70	
		82~1800	50~1100	65~1465	15000		80~1092	
32D		100~1600	60~1000	85~1280	25000		170~1080	
34S		82、100	50、60	65、85	30000		156、195	
		120~1600	75~1000	100~1280	40000		235~1500	
40D		100~1600	60~1000	85~1280	40000		241~1700	
53D		120~1600	75~1000	100~1280	70000		390~2500	

125°C Epoxy MOV (KK series)

Series	Figures	Breakdown Voltage	Maximum Operating Voltage		Maximum Single Peak Pulse Current		Maximum Energy (10/1000µs)	
		V _{1mA} (V)	V _{AC} (V)	V _{DC} (V)	Standard type I(A)	High Energy type I(A)	Standard type (J)	High Energy type (J)
7K		180~560	115~350	150~460	1200	1750	11.7~35.0	16.0~49.0
10K		180~560	115~350	150~460	2500	3500	27.0~70.0	30.0~92.0
14K		180~560	115~350	150~460	4500	6000	50.0~125.0	60.0~185.0
20K		180~560	115~350	150~460	6500	10000	85~215	130~380

140°C Silicone MOV (KH series)

Series	Figures	Breakdown Voltage	Maximum Operating Voltage		Maximum Single Peak Pulse Current		Maximum Energy (10/1000µs)	
		V _{1mA} (V)	V _{AC} (V)	V _{DC} (V)	Standard type I(A)	High Energy type I(A)	Standard type (J)	High Energy type (J)
5H		18~68	11~40	14~56	100	250	0.4~1.6	0.6~2.2
		82~750	50~460	65~615	400	800	2.5~21.8	4.0~32.0
7H		18~68	11~40	14~56	250	500	0.9~3.6	2.0~7.0
		82~910	50~550	65~745	1200	1750	5.0~57.0	10.0~78.0
10H		18~68	11~40	14~56	500	1000	2.1~8.2	3.0~15.0
		82~1200	50~750	65~990	2500	3500	12.0~127.0	17.0~165.0
14H		18~68	11~40	14~56	1000	2000	4.0~14.0	7.0~24.0
		82~1600	50~1000	65~1280	4500	6000	22.0~243	27.0~331
		1800	1100	1465	4500	5000	250	335
20H		18~68	11~40	14~56	2000	3000	11~41	13~49
		82~1800	50~1100	65~1465	6500	10000	45~625	56~990

TMOV

Series	Figures	Varistor Voltage	Maximum Allowable Voltage		Maximum Peak Current (8/20µs)		Maximum Energy (J)	
		V _{1mA} (V)	V _{AC} (V)	V _{DC} (V)	1 time I(A)	2 time I(A)	10/1000µs	2ms
14M(E.N)		82~120	50~75	65~100	4500	2500	27~40	22~329(2ms)
		150~1200	95~750	125~990	6000	4500	50~338	35~215(2ms)
20M(E.N)		18~39	11~25	14~32	3000	2000	13~28	10~21(2ms)
		47~68	30~38	38~56	5000	3000	34~49	25~37(2ms)
25M(E.N)		82~120	50~75	65~100	6500	4500	56~85	42~63(2ms)
		150~1200	95~750	125~990	10000	8000	100~650	70~460(2ms)
25M(E.N)		150~1200	95~750	125~990	15000	12000	160~840	105~590(2ms)

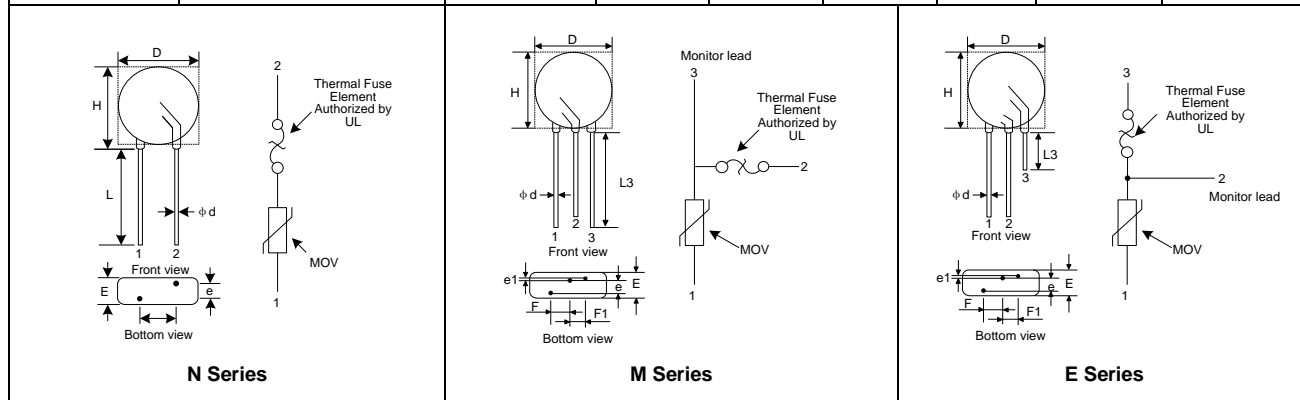

6. Yageo GDT&SPG Products Line

Two electrodes						
Series	DC Breakdown Voltage Range (V) 100V/s	Maximum Impulse Spark-over Voltage Range (V) 1000V/μs	Nominal Impulse Discharge Current (kA) 8/20μs	Maximum Capacitance (pF) 1MHz	Figures	Size(mm) L*W*H (T*D)
B32	(150~470) ±30%	750~1050	0.5	0.5		L3.2*W1.6*H1.6
B32-H2.5	(90,150) ± 30%	700~750	1.0	0.5		3.2*2.5*2.5
	(200,300) ± 20%	800~850				
	400 (360~580)	950				
2R-3-S	(90~400) ± 20%	650~1100	1.0	0.5		T3.5*D2.8
	500± 30%	1300				
4532	(75~500) ±30%	600~1100	2	0.5		4.5*3.2*2.7
	(600~800) ±30%	1200~1600	1.0			
	(1000~1500) ±20%	2400~2800				
2R-4-H3.5	(90~470) ±30%	650~1000	3	0.5		T4.0*D3.5
2R-4	(75~1200) ±20%	800~1900	3	1.0		4.0*4.2*4.2
2R-5-SST4.2	(75~600) ±20%	700~1200	5	1.0		4.2*5.0*5.0
	(800,1000) ±20%	1600,1800	3			
2R-5-ST5	(90~470) ±20%	650V~1100	5	1.0		T5.0*D5.0
2R-5-SS	(1000~2500) ±20%	1900~3600	3	1.5		6.0*5.6*5.6
2R-5	(70~800) ±20%	800~1700	5	1.5		6.0*Φ5.5
	(70~230) ±20%	600~700	10			
	(3000~3600) ±20%	4600,5000	3			
2R-5-UT5	(75~250)±20%	650~750	10	1.0		T5.0*D5.4
	(300~1000)±20%	800~2000	5	1.0		
	(1200,1500) ±20%	2400,2800	3	1.0		
2R-6	(75~800) ±20%	700~1200	5	1.0		4.2*6.2*6.2
	(1000~1800) ±20%	1600~2600	3			
2R-6*7	(1000~3600) ±20%	2000~4700	3	0.5		7.0*Φ6.0
2R-8*6(T6)	(1000~1600) ±20%	1900~2400	10	1.5		6.0*Φ8.0
	(2000~3000) ±20%	3200~4200	5			
2R-8*6	(75~800) ±20%	600~1500	10/20	1.5		6.0*Φ8.0
2R-8*6(D1)	(75~800) ±20%	600~1500	20	1.5		6.0*8.0
2R-8*6(S)	(75~1000) ±20%	600~1700	10/20	1.5		6.0*8.3*8.3
2R-8*8	(1000~2500) ±20%	1400~3600	5	1.5		8.0*Φ8.0
	(1400~3600) ±20%	2200~5200	2.5	1.5		
	(2700~4000) ±20%	4000~5500	3	1.5		
B600-60KA(003)	600±20%	1400	60(8/20μs),10(10/350μs)	5		See datasheet
B800-60KA(003)	800±20%	1600	60	5		See datasheet
B600-80KA(F14)	600±20%	1400	80(8/20μs)/25(10/350μs)	8		See datasheet
B600-80KA-T(013)	600±20%	1400	80(8/20μs)/15(10/350μs)	7		See datasheet























B600-100KA(004)	600±20%	1400	100(8/20µs)/20(10/350µs)	8		See datasheet
---------------------------------	---------	------	--------------------------	---	---	---------------

Three electrodes						
Series	Figures	DC Breakdown Voltage (V) 100V/s	Impulse Breakdown Voltage (V) 1000V/µs	Nominal Discharge Current (kA) 8/20µs	Capacitance (pF) 1MHz	Size(mm) L*W*H (L*Φ)
3R-3-SSS		(90~470)±30%	700~1200	2	1.0	T6.8*D3.5
		420 (360~560)	1200	2	1.0	
3R-5-S		(75~600) ±20%	700~1000	5	2.0	7.2*5.0
3R-6-SSS		(75~600) ±20%	750~1300	5/10	2.0	8.5*6.0
3R-6		(75~600) ±20%	750~1300	5/10	2.0	8.5*6.0
3R-8		(75~800) ±20%	700~1500	10/20	2.0	10.0*8.0
3R-8-SSS		(75~800) ±20%	700~1600	10/20	2.0	10.0*8.0
3R-8-S		(75~600) ±20%	700~1300	10/20	2.0	10.0*8.0

SPG Products Line					
Series	DC Breakdown Voltage Range V	Surge Current Capacity (8/20µs) kA	Maximum Capacitance (1KHz-6VMAX) pF	Figures	Size (mm) L , Φ
BK1-M	140~1000	3	0.8		(6.0±0.5) * (Φ3.3±0.5)
BK1-H	1000~5000	1.5	1.0		(9.0±1.5) * (Φ4.1±0.5)
BK1	140~700	3	0.8		(4.0±0.5) * (Φ3.1±0.5)
BK1-MS	140~1000	3	0.8		(6.0±0.5) * (Φ3.2±0.2)
BK2	140~1500	1	0.8		(4.3±0.5) * (Φ2.6±0.5)
BK2-M	140~1000	1	0.8		(5.0±0.5) * (Φ2.8±0.5)
BK3	140~700	0.5	0.8		(4.0±0.5) * (Φ2.0±0.5)
BK3-M	140~300	0.3	0.8		(3.4±0.5) * (Φ1.4±0.5)
BK3-M(H)	140~1000	0.5	0.8		(4.0±0.5) * (Φ2.1±0.5)

7. Yageo ESD Products Line

Standard capacitance



Part Number	Internal Configuration	Reverse stand-off voltage V_{RWM} (V)	ESD Test Level IEC61000-4-2 Contact/Air	Junction Capacitance C_j (pF)	Figures
SCS08CXXL07		5/12/15/24	$\pm 8kV/\pm 15kV$	350/120/75/50	 SOIC-08
SES08C15L04		15	$\pm 30kV/\pm 30kV$	80	
SAT36A05L05		5	$\pm 8kV/\pm 15kV$	50	 SOT-363
SDT23C712L02		7 (pin1/2 to pin3) 12 (pin3 to pin1/2)	$\pm 30kV/\pm 30kV$	75	 SOT-23
SDT23CXXL02		5/12/15/24	$\pm 30kV/\pm 30kV$	150/65/60/40	
SET23AXXL02		3.3/5/12/15/24/36	$\pm 8kV/\pm 15kV$	300/220/100/90/80/70	SOT-23
SJD12C6.5L01		6.5	30kV/ $\pm 30kV$	-	 SOD-123S
SJD12A12L01		12			
SDD32A05L01		5	$\pm 30kV/\pm 30kV$	350	 SOD-323
SDD32A12L01		12	$\pm 30kV/\pm 30kV$	150	
SDD32A36L01		36	$\pm 8kV/\pm 15kV$	70	
SDD32C05L01		5	$\pm 30kV/\pm 30kV$	100	SOD-323
SDD32C36L01		36	$\pm 25kV/\pm 24kV$	30	
SFD52A07L01		7	$\pm 30kV/\pm 30kV$	190	 SOD-523
SBD52C05L01		5	$\pm 30kV/\pm 30kV$	30	
SDD52C05L01		5	$\pm 30kV/\pm 30kV$	30	
SJD16AXXL01		5/7/10/12/15/18/24	$\pm 30kV/\pm 30kV$	300~1000	 DFN1610
SBD8C05L01		5	$\pm 30kV/\pm 30kV$	30	 SOD882(DFN1006)
SHD8C4.5L01		4.5	$\pm 30kV/\pm 30kV$	80	
SDD8A12L01		12	$\pm 30kV/\pm 30kV$	55	







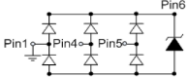

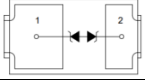

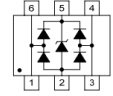

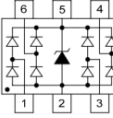
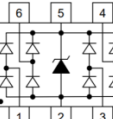

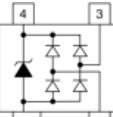
Low capacitance

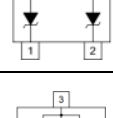
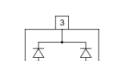

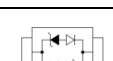

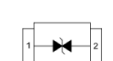







Part Number	Internal Configuration	ESD Test Level IEC61000-4-2 Contact/Air	Reverse stand-off voltage V_{RWM} (V)	Junction Capacitance C_j (pF)	Figures
LES16CXXL08		±30kV/±30kV	5/12/15/24/36	15	 SOIC-16
LES08C05L04		±30kV/±30kV	5	5	 SOIC-08
LES08A05L05		±30kV/±30kV	5	15	
LHS08A12L04		±8kV/±15kV	12	25	
LTS08AXXL02		±30kV/±30kV	3.3/6	30	 SOT-23
LBT23C12L02		±8kV/±15kV	12	15	
LBT23C24L02			24	12	
LBD32C1524L01		±8kV/±15kV	15(pin1 to pin2) 24(pin2 to pin1)	20	 SOD-323
LAD52C03L01		±30kV/±30kV	3.3	10	 SOD-523
LAD52C05L01			5	12	
LBD52A24L01		±20kV/±20kV	24	30	
LBD52A36L01			36	20	
LAD8C05L01		±8kV/±15kV	5	10	 SOD-882
LBD8A24L01			24	30	
LAD92C5.0L01		±8kV/±15kV	5	15	 SOD-923
LBQ02C05L01		±8kV/±15kV	5	8	 DFN0603/QFN-0201
LAQ02A05L01		±20kV/±20kV	5	40	
LAQ02A12L01		±20kV/±20kV	12	20	

Ultra low capacitance

Ultra-Low Capacitance					
Part Number	Internal Configuration	ESD Test Level IEC61000-4-2 Contact/Air	Reverse stand-off voltage V_{RWM} (V)	Junction Capacitance C_j (pF)	Figures
UFS08A2.8L04		$\pm 30kV/\pm 30kV$	2.8	6	 SOIC-8
UFS08C2.8L04		$\pm 30kV/\pm 30kV$	2.8	8	
UES08A03L05		$\pm 30kV/\pm 30kV$	3.3	5	
UDS08A24L04			24	3	
UDS08C24L04			24	3	
UAD33A05L06		$\pm 10kV/\pm 10kV$	5	0.2	 DNF3310
UEDF3A2.8L04		$\pm 30kV/\pm 30kV$	2.8	5	 DNF3020
UEDF3A3.3L04		$\pm 30kV/\pm 30kV$	3.3	5	
UED26A03L05		$\pm 30kV/\pm 30kV$	3.3	5.0	 DFN2626
UBQ10A03L04		$\pm 20kV/\pm 25kV$	3.3	0.6	 DFN-10/DFN2510
UBQ10A05L04HI		$\pm 20kV/\pm 20kV$	5	0.6	
UBQ10A05L04-LV		$\pm 10kV/\pm 10kV$	5	0.35	
UBQ10A05L04-R0.4		$\pm 10kV/\pm 10kV$	5	0.3	
UAD20C03L02		$\pm 20kV/\pm 20kV$	3	3	 DFN-2010-8L
UAD20A05L04		$\pm 20kV/\pm 20kV$	5	0.6	 DFN2010-10
UAD20C05L04-R0.4		$\pm 10kV/\pm 10kV$	5	0.4	 DFN-2010-5L
UCQ06A05L05		$\pm 30kV/\pm 30kV$	5.0	1.0	 DFN1616

UAD11A05L03		±10kV/±10kV	5.0	0.25	 DFN1109
UAD03C05L01		±8kV/±15kV	5	0.5	DFN1608

Ultra-Low Capacitance						
Part Number	Internal Configuration	ESD Test Level IEC61000-4-2 Contact/Air	Reverse stand-off voltage V _{RWM} (V)	Junction Capacitance C _j (pF)	Figures	
UBT26A05L03		±8kV/±15kV	5.25	3.5	 SOT23-6L	
UAT26A03L05		±8kV/±15kV	3.3	0.5		
UCT26A05L05-HP1		±30kV/±30kV	5	2		
UDT26A05L05-LC1		±20kV/±25kV	5	0.8		
UET26A05L05-IP38		±30kV/±30kV	5	5		
UAT36A03L05			±8kV/±15kV	3.3	0.5	 SOT-363
UAT36A05L05	±8kV/±15kV		5	1		
UAT56A03L05			±8kV/±15kV	3.3	0.5	 SOT-563
UAT56A05L05			±8kV/±15kV	5	1	
UDT14A05L03				±30kV/±30kV	5	
JET14A05L03-BK	±8kV/±15kV	5		0.8		
UAT14A07L03	±20kV/±20kV	7.5		1		
UAT14A15L03	±20kV/±20kV	15		1		
UBT32A05L02		±8kV/±15kV	5	0.8	 SOT-323	
UAT52A05L02		±8kV/±15kV	5	0.8	 SOT-523	
UBT23A05L02		±8kV/±15kV	5	0.8	 SOT-23	
UDT23AXXL02		±30kV/±30kV	3.3/5/12/15/24	0.8		
UDD32CXXL01		±30kV/±30kV	3.3/5/8/12/15/24/36	0.8/0.8/1/0.8/0.8/0.8/0.8	 SOD-323	
UCD32CXXL01		±30kV/±30kV	8/12/15/24	2		
UBD32C05L01		±8kV/±15kV	5	0.4		

UAD52A05L01		$\pm 8kV/\pm 15kV$	5	0.8	 SOD-523
UAD03C05L01		$\pm 8kV/\pm 15kV$	5	0.7	 DFN1608
UAD8A05L02		$\pm 8kV/\pm 15kV$	5	0.5	 DFN1006-3L
UAD8C03L01		$\pm 8kV/\pm 15kV$	3	0.5	 SOD882
UAD8C05L01		$\pm 8kV/\pm 15kV$	5	0.4	
UAD8C18L01		$\pm 8kV/\pm 15kV$	18	0.6	
UBD8C18L01		$\pm 8kV/\pm 15kV$	18	0.6	
UAQ02C05L01		$\pm 8kV/\pm 15kV$	5	5 max.	 DFN0603/QFN-0201
UAQ02C05L01-R0.5		$\pm 20kV/\pm 20kV$	5	0.5 max.	

8. Yageo NTC Products Line



Temperature NTC

Series	Figures	Zero Power Resistance At 25 °C	Beta Value	Operating Temperature Range	Max Power
NA		1K~150KΩ	B(25/85)3435~4262	-40~+125°C	75mW

Power NTC

Series	Figures	Disc	Zero Power Resistance At 25 °C	Max. Steady State Current	Max Steady Energy	Recommend Capacitance at 340Vdc
SP		8Φ~25Φ	0.7~150Ω	1~15A	3.5~71.4J	60~1240μF
NT (High Surge)		5Φ~20Φ	0.7~45Ω	0.25~12A	2.3~69.1	40~1200μF

9. Yageo TSS Products Line

Series	Figures	V _{DRM} (V)	I _H (mA)	C _O (pF)	I _{PP} @10/1000μs (A)	Package
PxxxxTA		6~320	50/150	30~70	45	DO-214AC(SMA)
PxxxxSX		6~320	50/150	30~100	A:45,B:80,C:100	DO-214AA(SMB)
P61089B		-170	-150	50(V _D =-48V) 100(V _D =-3V)	30	SOP-8

10. Yageo PPTC Products Line

Series	Figures	I_{hold} (A)	I_{trip} (A)	$V_{max.}$ (Vdc) (V)	$I_{max.}$ (A)	$R_{min.} \sim R_{max.}$ (Ω)	Size, L*W(Max)
SMD 0603		0.04~0.5	0.12~1.00	6~24	40	0.10~40.0	1.8*1.0
SMD 0805		0.10~1.10	0.30~2.00	6/9/15	40/100	0.03~6.00	2.2*1.5
SMD 1206		0.05~2.00	0.15~3.50	6~30	100	0.018~50.00	3.4*1.8
SMD 1210		0.05~2.00	0.15~4.00	6~30	10/100	0.015~50.0	3.43*2.80
SMD 1812		0.10~3.00	0.30~5.00	6~60	10/20/40/100	0.012~15.00	4.73*3.41
SMD 2016		0.30~2.00	0.60~4.20	6~60	20/40	0.03~2.30	5.44*4.43
SMD 2920		0.30~5.0	0.60~10.0	6~60	10/40	0.005~4.800	7.98*5.44
BK 16		2~14	4~28	16	40/100	0.003~0.120	See datasheet
BK 30		0.90~9.00	1.80~18.00	30	40	0.005~0.220	See datasheet
BK 60		0.05~5.00	0.10~10.00	60	40	0.025~25.00	See datasheet
BK 130		0.10~1.35	0.20~2.70	130	20	0.2~18.0	See datasheet
BK 250		0.030~2.000	0.060~4.000	250	1/3/10	0.1~90.0	See datasheet
BK 600		0.11~0.16	0.22~0.32	500(ac)	3	4.0~18.0	See datasheet

11. Appendix: Summary of Test Standards

11.1 IEC61000-4-2 : ESD

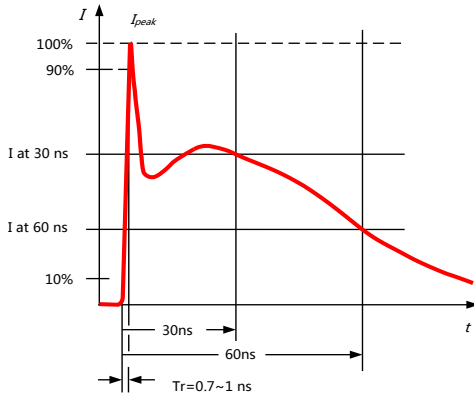

Electrostatic discharge waveform parameters					
Level	Indicated voltage	First peak current of discharge ($\pm 15\%$)	Rise time T_r ($\pm 25\%$)	Current ($\pm 30\%$) at 30 ns	Current ($\pm 30\%$) at 60 ns
	kV	A	ns	A	A
1	2	7.5	0.7~1	4	2
2	4	15	0.7~1	8	4
3	6	22.5	0.7~1	12	6
4	8	30	0.7~1	16	8

The reference point for measuring the time for the current at 30 ns and 60 ns is the instant when the current first reaches 10% of the 1st peak of the discharge current.
NOTE The rise time, T_r , is the time interval between 10% and 90% value of 1st peak current.

Test level				
Test level	Level 1 (KV)	Level 2 (KV)	Level 2 (KV)	Level 2 (KV)
Contact discharge	2	4	6	8
Air discharge	2	4	8	15

11.2 IEC61000-4-5: Surge

1.2/50 μ s & 8/20 μ s combination waveform

NOTE The value 1,67 is the reciprocal of the difference between the 0,9 and 0,3 thresholds. IEC 1143/14

Waveform of open-circuit voltage (1.2/50 μ s)

NOTE 1 The value 1,25 is the reciprocal of the difference between the 0,9 and 0,1 thresholds.
NOTE 2 The value 1,18 is derived from empirical data. IEC 1144/14

Waveform of short-circuit current (8/20 μ s)

Relationship between peak open-circuit voltage and peak short-circuit current		
Open-circuit peak voltage at generator output $\pm 10\%$	Short-circuit peak current $\pm 10\%$ (18 μ F)	Short-circuit peak current $\pm 10\%$ (9 μ F+10 Ω)
0.5kV	0.25kA	41.7A
1.0kV	0.5kA	83.3A
2.0kV	1.0kA	166.7A
4.0kV	2.0kA	333.3A

10/700 μ s & 5/320 μ s

Waveform of open-circuit voltage (10/700 μ s)

Waveform of the 5/320 μ s short-circuit current waveform

Relationship between peak open-circuit voltage and peak short-circuit current	
Open-circuit peak voltage $\pm 10\%$ at generator output	Short-circuit peak current $\pm 10\%$ at generator output
0.5kV	12.5A
1.0kV	25A
2.0kV	50A
4.0kV	100A

Table 1. Test levels

level	Open-circuit test voltage (kV)	
	Line-to-line	Line-to-ground ^b
1	...	0.5
2	0.5	1
3	1	2
4	2	4
X ^a	Special	Special

a "X" can be any level, above, below or in between the others. The level shall be specified in the dedicated equipment specification.
 b For symmetrical interconnection lines the test can be applied to multiple lines simultaneously with respect to ground, i.e. "lines to ground".

Table B.1 – Power ports: selection of the test levels (depending on the installation class)

Installation class	Test levels (kV)							
	AC power supply and a.c. I/O External ports ^a		AC power supply and a.c. I/O Internal ports ^{a,d}		DC power supply and d.c. I/O External ports ^a		DC power supply and d.c. I/O Internal ports ^{a,d}	
	Coupling mode		Coupling mode		Coupling mode		Coupling mode	
	Line-to-line	Line-to ground	Line-to-line	Line-to ground	Line-to-line	Line-to ground	Line-to-line	Line-to ground
0	NA	NA	NA	NA	NA	NA	NA	NA
1	NA	0.5	NA	NA	NA	NA	NA	NA
2	0.5	1.0	NA	NA	NA	NA	NA	NA
3	1.0	2.0	1.0	2.0	1.0	NA	1.0	1.0
4	2.0 ^b	4.0 ^b	2.0 ^b	4.0 ^b	2.0 ^b	4.0 ^b	2.0 ^b	4.0 ^b
5	^{c, b}	^{c, b}	2.0 ^b	4.0 ^b	2.0 ^b	4.0 ^b	2.0 ^b	4.0 ^b

^a No test is advised if the cable length is shorter than or equal to 10 m.
^b Where the port is always intended to be used with specified primary protection, testing is performed with the primary protection in place to ensure coordination with the protection elements. If primary protection is required to protect the interface but not provided, testing is also performed at the maximum let through level of the specified primary protection and with a typical primary protector.
^c Depends on the class of the local power supply system.
^d The testing of intra-system ports is generally not required.

Table B.2 – Circuits/lines: selection of the test levels (depending on the installation class)

Installation class	Test levels (kV)											
	Unsymmetrical operated circuits/lines ^{a,c,e}				Symmetrical operated circuits/lines ^{a,c,e}				Shielded circuits/lines ^{a, d, e}			
	External port		Internal port		External port		Internal port		External port		Internal port	
	Line to line	Line to ground	Line to line	Line to ground	Line to line	Line to ground	Line to line	Line to ground	Line to line	Line to ground	Line to line	Line to ground
0	NA	NA	NA	NA	NA	NA	NA	NA	NA	NA	NA	NA
1	NA	NA	NA	0.5	NA	NA	NA	0.5	NA	NA	NA	NA
2	NA	NA	0.5	1.0	NA	NA	NA	1.0	NA	NA	NA	0.5
3	NA	NA	1.0	2.0	NA	NA	NA	2.0	NA	NA	NA	2.0
4	2.0 ^b	4.0 ^b	2.0 ^b	4.0 ^b	NA	4.0 ^b	NA	4.0 ^b	NA	4.0 ^b	NA	4.0 ^b
5	2.0 ^b	4.0 ^b	2.0 ^b	4.0 ^b	NA	4.0 ^b	NA	4.0 ^b	NA	4.0 ^b	NA	4.0 ^b

^a No test is advised for data connections intended for cables shorter than 10 m.
^b Where the port is always intended to be used with specified primary protection, testing is performed with the primary protection in place to ensure coordination with The protection elements. If primary protection is required to protect the interface but not provided, testing is also performed at the maximum let through level of the specified Primary protection and with a typical primary protector.
^c Line-to-line surges (transverse) may occur in networks where SPDs (surge protective devices) with connection to ground are used for protection. Such surges are outside the scope of this standard. This phenomenon can however be simulated by applying common mode surges through the defined primary protection elements.
^d The testing of ports connecting to antennas is outside the scope of this standard.
^e The testing of intra-system ports is generally not required.

Yageo Corporation Headquarters

A: 3F, 233-1, Baoqiao Rd. Xindian Dist.,
New Taipei City 23145 Taiwan
T: +886-2-6629-9999
F: +886-2-6628-8885

Yageo Dongguan (Song Shan Lake Factory)

A: #3 Building, Modern enterprise accelerator park,
Song Shan Lake High-tech Industrial development zone,
Dongguan City, Guangdong Province, P.R.C
T: +86-769-26626898
F: +86-769-26626198