

ESSENTIAL GUIDE TO BRUSHLESS DC MOTOR CONTROLS



Sponsored by:

TOSHIBA

Introduction

Electric motors are everywhere. To confirm this yourself, take an inventory of the motors you personally own or use at home, in the car, or at the office. If you are diligent enough, you will be surprised to discover that you have a dozen or more, many of which are brushless DC (BLDC) motors such as computer fans, CPAP machines, power tools, etc. This paper discusses brushless DC motors, one of three common types of DC motors; the other two are brushed and stepper motors.

BLDC Applications

There are numerous applications for BLDC motors. Here are some of the most common:

- Transportation – Electric motors have become the go-to motor for all types of transportation vehicles: small cars, golf carts, bicycles, wheelchairs, scooters, and drones.
- Power tools – Because of their efficiency, battery-powered tools — drills, screwdrivers, saws, electric lawnmowers, and string trimmers, among many others — have moved almost exclusively to the BLDC motor. The high efficiency provides not only power but also more time between charges and longer battery life.
- Industrial and Manufacturing – Factories deploy hundreds of motors to control machines of all sorts. Additional uses are in servo-controlled devices and robots. Speed and torque are readily controlled to meet almost any need. The high efficiency and low maintenance make it possible to save on power and maintenance costs.
- Appliances – High-end vacuums, washers, and dryers employ BLDC motors where performance, quietness, and longevity are essential.
- HVAC – Heating, ventilation, and air conditioning systems make significant use of BLDC motors in fans, pumps, and now even compressors. Refrigeration equipment also uses BLDC motors to great benefit.
- Radio-controlled models – R/C models of cars, airplanes, and drones are abandoning the old noisy internal combustion motors for BLDC motors. They are powerful, efficient, and provide long battery life.



BLDC Advantages and Disadvantages

As the name implies, no brushes are used in BLDC motors. The rotor moves relatively frictionless with the stator. This approach offers engineers several advantages: With no brushes and their attendant friction and sparking, the BLDC motor is more reliable as it needs little to no maintenance and has a longer life.

A brushless motor also provides these advantages:

- Has improved (higher) speed to 10,000 rpm or more plus torque control capability;
- Provides higher efficiency, typically 85% to 90% vs. 75% to 80% for brushed motors;
- Offers low noise operation;
- Reduces electromagnetic interference (EMI).

The primary disadvantages of a BLDC motor over a brushed motor include:

- Higher cost. However, if you consider the manufacturing cost reductions and the lower lifetime maintenance cost, the BLDC motor could be a better investment.
- Requirement for complex drive and control circuitry. However, modern semiconductor technology can reduce this complexity.

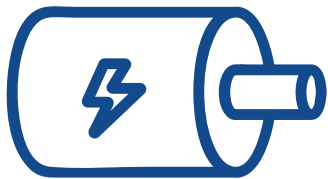

BLDC Motor Tutorial

BLDC motors, like all DC motors, produce rotation or other motion by the interaction of two magnetic fields: an electromagnet and a permanent magnet. Putting the two together so that they attract and repulse produces the rotational motion.

Figure 1 The stator windings on opposite poles are connected in series (A1 – A2, B1 – B2, C1 – C2) to form the three phases of the BLDC motor. In some motors, Hall Effect sensors (H1, H2, H3) are placed in the stator to detect the position of the rotor, thereby providing information to the controller.

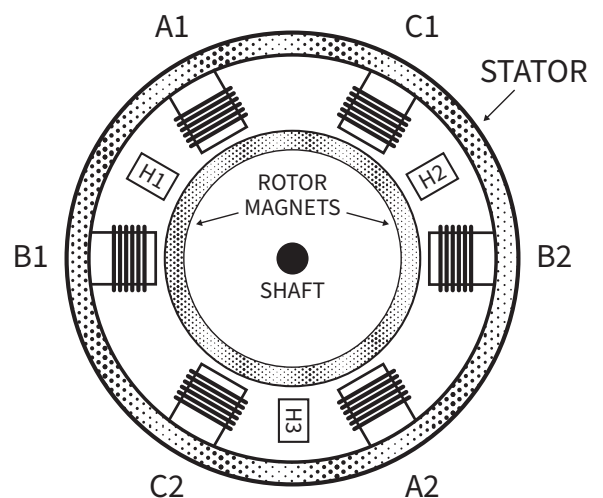

Fig. 1 shows the basic architecture of a BLDC motor. It is typically made up of a stator that contains multiple windings creating electromagnets. The rotational part of the motor, the rotor, contains permanent magnets that interact with the windings to produce motion.

To produce motion, a series of pulses are applied to the stator windings in a specific sequence. As the magnetic fields change and interact with the rotor, motion is produced.

The number of stator windings and the number of permanent magnets (pole-pair) in the rotor vary with the size and type of BLDC. The more numbers of stator and pole-pair, the higher the torque the rotor can generate. Most BLDC motors commonly use three groups of windings to produce a sequence of pulses that interact with the rotor magnets. These three sets of pulses provide the rotational capability.

There are generally three groups of BLDC motors. One-phase BLDC motors are primarily used for low torque/low inertia fan applications. Two-phase BLDC motors, recently introduced, are not widely adapted at present. The most common BLDC is the three-phase DC motor.

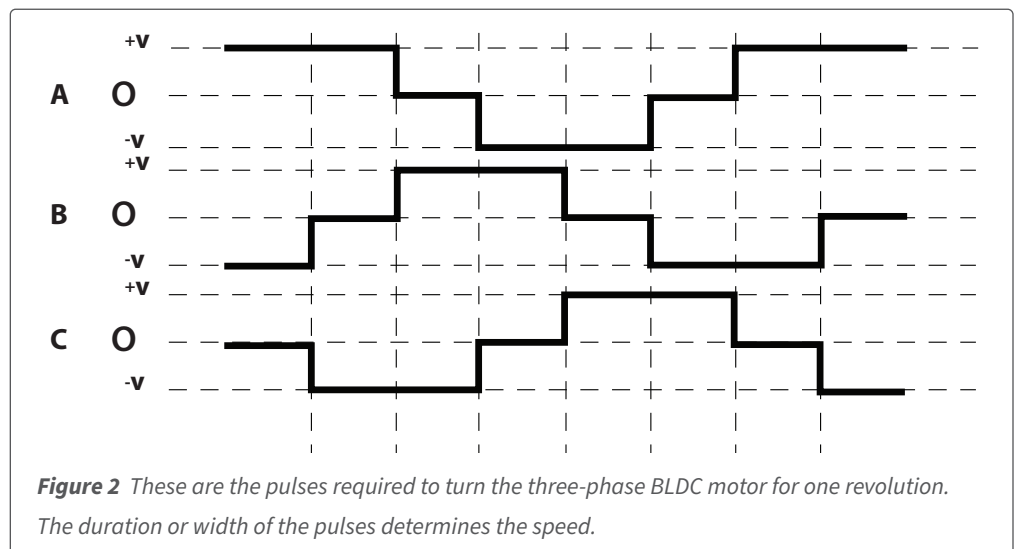

Fig. 2 shows the typical pulses that are applied to a BLDC for rotation. These are repetitive plus and minus pulses that drive the motor by way of driver circuits made up of MOSFETs, as shown in **Fig. 3**.

For the motor to rotate, the timing of the pulses must be such that they interact with the permanent magnets. That means that the controller circuitry driving the stator coils should know the position of the rotor before the pulse sequence is applied. Some BLDC motors have sensors that indicate the rotors' position.

The most efficient BLDC motor is the sine-wave-driven type. It typically uses three 120-degree shifted sine waves to produce rotation. The amplitude of the applied sine waves is a major factor in controlling speed and torque.

Sensor and Sensorless Control

Brushless DC motors require electronic circuits to turn the stator coils off and on and switch polarity to produce the rotor's rotation. Speed and torque are controlled by varying the timing, duration, sequencing, amplitude, and polarity of pulses applied to the stator windings to produce the desired operation. BLDC motors are often referred to as electronically commutated motors.

As mentioned earlier, the most common BLDC motor is a three-phase Wye-configured device. The stator structure looks like **Fig. 1**. There are six stator coils wired into pairs and connected into a basic "Y" Wye configuration. The rotor assembly contains powerful permanent magnets and rides inside the stator. The actual configuration varies from motor to motor.

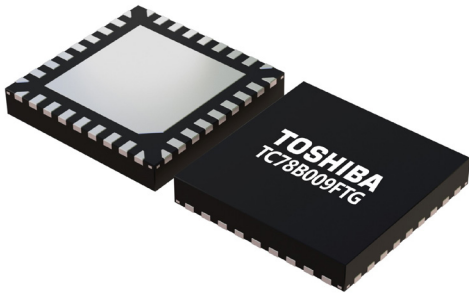

To cause rotation, the stator coils are energized by a series of pulses as shown in **Fig. 2**. The pulses are such that two sets of stator windings are energized at a time: one positive, one negative, and the other open or floating. The resulting electromagnetic fields interact with the permanent magnets on the rotor to produce rotation. The rotor follows the stator magnets as they are energized.

BLDC motors are bidirectional in that the shaft can be made to rotate in either direction. This requires reversing the sequence of the drive pulses, which is done within the controller, usually with programming in the microcontroller unit (MCU) or in a dedicated motor control device (MCD).

It is important to point out that an MCU is not always required. Some companies, like Toshiba, produce special MCDs (for instance, the TC78B009FTG) that simplify the control process. For example, the rotation can be determined by a direction control input to set direction. The switching of the pulses is accomplished within the MCD.

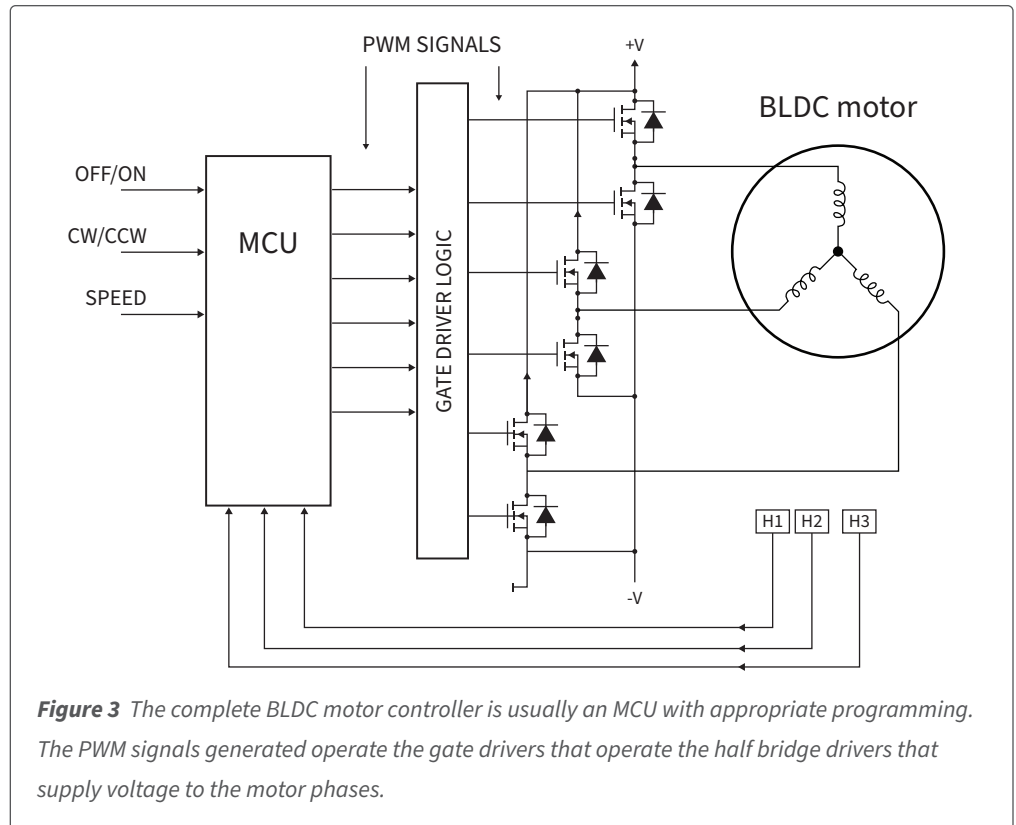
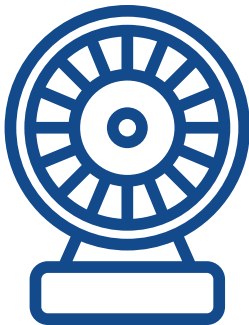

Figure 3 The complete BLDC motor controller is usually an MCU with appropriate programming. The PWM signals generated operate the gate drivers that operate the half bridge drivers that supply voltage to the motor phases.

For the rotor to turn, it must be in the right position with respect to the stator coils. If it is not aligned correctly, no rotation occurs. For that reason, BLDC motors must provide a signal that gives the proper position information to the circuitry driving the stator pulses.

This is usually done in two ways. One common method is to embed sensors inside the stator at the critical points. Hall Effect sensors are typically used. These are spaced 120 degrees apart for the three-phase BLDC motors and provide logic signals to the stator pulse circuits.

Fig. 3 shows a complete diagram of the BLDC sensor-based motor control circuitry. In this hypothetical controller, the Hall Effect sensor outputs are usually digital and read by general-purpose input output (GPIO) inputs on the MCU or MCD. The controller generates the signals that provide inputs to the gate drive circuits. These gate drive signals are pulse-width modulating (PWM) to provide speed control. The output stage of the inverter delivers the pulses and current to the stator phase windings.

A second common method is a sensorless approach that uses the back electromotive force (back-EMF) that is induced into the stator coils by the rotating rotor magnets. These voltages are used to time the stator pulses.

In the sensorless approach to control, the back-EMF signal developed across the unenergized (electrically disconnected) winding provides a signal that enables the motor controller or MCU to generate the drive signals. The back-EMF is developed when the rotor passes the stator pole, which is the same time you want to energize that stator winding. The actual sampling of the back-EMF is typically done just before or after the conducting phase. Some schemes even sample during the conduction phase, but this is more complex.

The back-EMF signals are typically trapezoidal in shape, as shown in **Fig. 4**. However, some BLDC motors develop sinusoidal back-EMF. This makes the control signals to the stator windings sinusoidal in nature, thereby providing a much smoother operation. Typically, if the windings produce sinusoidal back-EMF, the motor is referred to as a permanent magnet synchronous motor, or PMSM.

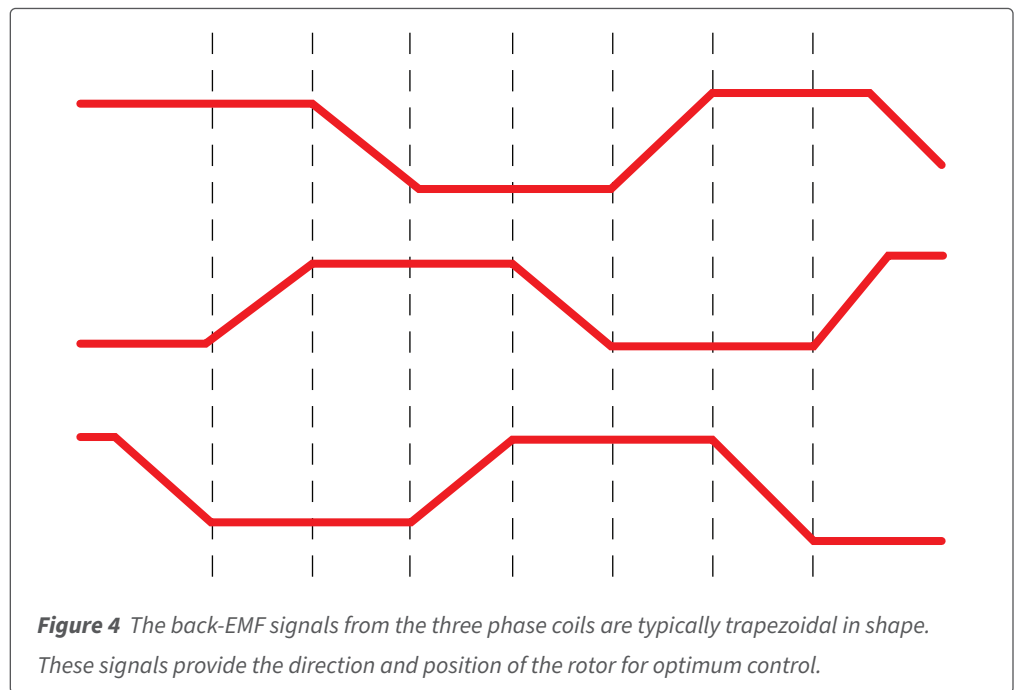

Open- and Closed-Loop Speed Control

BLDC motors' speed may be controlled with or without feedback. With open-loop control, a constant speed is set by the controller that, in turn, sets the PWM outputs to produce the desired speed. Since the speed can vary with the load, a manual speed adjust can be provided by an analog-to-digital conversion (ADC) reading an external pot setting and adjusting the PWM output accordingly.

Self-correcting operation is also possible with a closed-loop configuration. Mission critical applications where dynamic load change occurs will benefit from the self-adjustment.

Self-correcting operation is also possible with a closed-loop configuration. Mission-critical applications where dynamic load change occurs will benefit from the self-adjustment. Several methods can provide more sophisticated or precise control, depending upon the application. With closed-loop control feedback from the motor, speed indication must be provided by a speed sensor. The controller reads the pulses, calculates the speed, then produces the necessary PWM output to maintain that speed. In noncritical applications, the speed can be determined by measuring the time between successive Hall Effect feedback pulses by using a timer in the MCU.

There are also motor control ICs that perform closed-loop speed regulation within the ICs without the need for external host processing, encoders, and the peripheral circuits. Toshiba's TC78B009FTG, for instance, allows for this possibility.

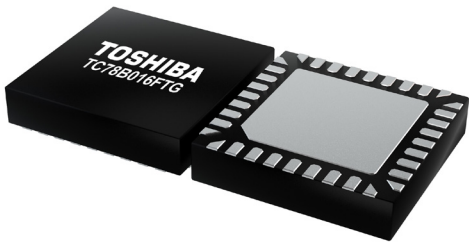

Intelligent Phase Control

This is yet another method that improves efficiency by synchronizing the phases of the driving voltage and current automatically. This technique maximizes the active power and minimizes the reactive power to the motor. It reads the stator current phases, then adjusts in the controller to optimize the drive signals. An Intelligent Phase Control part for consideration is the TC78B016FTG.

Field-Oriented Control (FOC)

Another method is Field-Oriented Control (FOC), which is useful in providing more precise and efficient control of speed and torque. This technique attempts to adjust the stator coil magnetic fields at a right angle to the rotor magnet fields and therefore produces the maximum torque. This approach may require complex software to implement high-resolution floating-point math calculations.



Some techniques use high-speed digital signal processing (DSP) and/or dedicated hardware, such as Toshiba's Vector Engine, to calculate field vectors in real time and perform transforms from time domain to frequency domain and back to time domain. The key to FOC is that the main transform is being executed from a stationary plane to rotor plane and back. A device such as the TPM375FSDMG has the dedicated Vector Engine hardware to process FOC as well as an ARM MCU for overall system control.

Conclusion

BLDC motors are increasingly used to replace brushed motors in many applications because of their significant advantages. These include efficiency, low maintenance, and the reliability for longevity, in addition to their rapid response to speed and torque variations. Their somewhat higher cost can often be justified simply on these inherent benefits.

BLDC motor control can range from simple to complex, depending upon the application. In most cases, there is a commercial controller IC or other solution available. For simple uses — such as a fan where speed is relatively constant and no major control functions are required — a basic MCD can be used. These devices vary in complexity, featuring differing levels of circuit integration depending upon the manufacturer. A fully integrated MCD offers the control logic plus gate driver and MOSFETs that drive the stator windings. MCDs usually provide all the logic needed for full motor control without the MCU processing other than just speed and direction commands. Therefore, no programming is required.

For more advanced applications, a dedicated motor control MCU may be considered. One example is a battery-operated power tool that experiences a wide range of speed and torque needs. The typical BLDC motor control MCU is an ARM-based 32-bit device with varying options of RAM, flash memory, I/O ports, ADCs, timers, and related circuits. External gate drivers and MOSFETs complete the motor controls to meet various levels of power density requirements. Vendor support for software is usually available.



MOTOR CONTROL TECHNOLOGIES

Below, for your reference, are the flagship motor control products from Toshiba that feature the technologies described in this article:

Intelligent Phase Control - TC78B016FTG

Close Loop Speed Control - TC78B009FTG

Field Oriented Control - TMPM375FSDMG

For more information, click [here](#).