

MIL-DTL-26482 H Series I circular connectors
Souriau 851 series

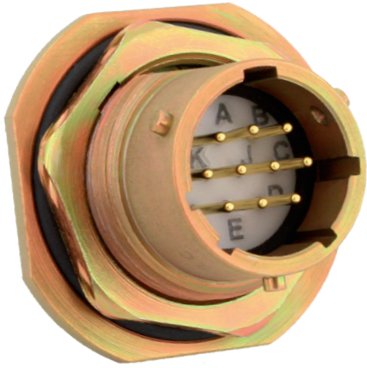

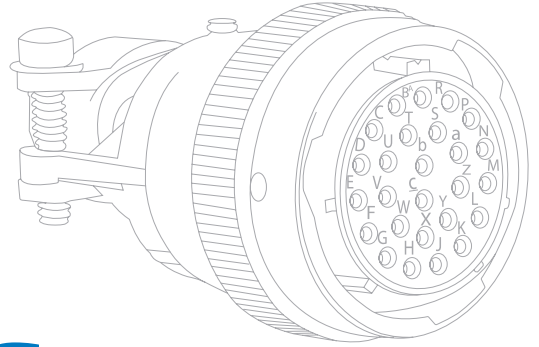

851 series

MIL-DTL-26482 H Series I

Typical applications



Table of contents

Overview	4
Receptacle range overview	4
Plug range overview	7
Ordering information.....	8
Contact layouts.....	10
Soldier or crimp contacts.....	13
PC tail contacts.....	14
Cross reference	15
Environmental versions	17
Hermetic versions.....	18
Connectors	19
Environmental connectors.....	19
Hermetic connectors	42
PC tail connectors.....	44
Panel.....	45
Specific connectors	46
Push-pull locking plug	47
Contacts and accessories.....	48
Crimp contacts	48
Ordering information.....	49
Caps.....	50
Accessories	52
Technical information	53
Tooling	53
Stripping and crimping instructions	54
Insertion and extraction instructions.....	55
Drilling pattern - male rear face.....	56
Discrimination/keying methods	62

Souriau 851 series

Receptacle range overview

Square flange receptacle type 00

Front view

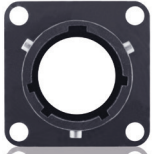

00A/RA



Square flange receptacle with straight adapter

Page 19

00AC



Square flange receptacle with straight cable clamp without grommet

Page 19

00EC/RC



Square flange receptacle with straight cable clamp

Page 19

00E/R



Square flange receptacle with backnut

Page 20

00G/RG



Square flange receptacle with removable straight backshell for screen termination and heatshrink sleeving

Page 20

00J



Square flange receptacle with straight sealing gland backshell

Page 21

00JC



Square flange receptacle with straight sealing gland and cable clamp

Page 21

00M/RM



Square flange receptacle with removable straight backshell for heatshrink sleeving

Page 22

00P/RP



Square flange receptacle with straight backshell for potting

Page 22

00T/RT



Square flange receptacle with straight backshell for heatshrink sleeving

Page 23

00T/RT..38/42



Square flange receptacle with removable backshell and heatshrink sleeving

Page 23

Cable in-line receptacle type 01

Front view



01A/RA



Square flange receptacle with straight adaptor
Page 24

01AC



Square flange receptacle with straight cable clamp without grommet
Page 24

01EC/RC



Square flange receptacle with straight cable clamp
Page 24

01E/R



Square flange receptacle with backnut
Page 25

01G/RG



Square flange receptacle with removable straight backshell for screen termination and heatshrink sleeving
Page 25

01J



Square flange receptacle with straight sealing gland backshell
Page 26

01JC



Square flange receptacle with straight sealing gland and cable clamp
Page 26

01M/RM



Square flange receptacle with removable straight backshell for heatshrink sleeving
Page 27

01P/RP



Square flange receptacle with straight backshell for potting
Page 27

01T/RT



Square flange receptacle with straight backshell for heatshrink sleeving
Page 28

01T/RT..38/42



Square flange receptacle with removable backshell and heatshrink sleeving
Page 28

Souriau 851 series

Receptacle range overview

Square flange receptacle type 02

Front view

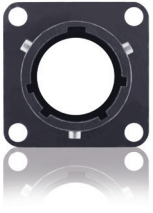

02E/02R/02H



Square flange receptacle not accepting backshell

Page 29 and 44

Jam nut receptacle type 07

Front view



07A/07H



Jam nut receptacle not accepting backshell

Page 29 and 44

07AC



Jam nut receptacle with straight cable clamp without grommet

Page 30

07E/R



Jam nut receptacle with backnut

Page 30

07EC/RC



Jam nut receptacle with straight cable clamp

Page 30

07G/RG



Jam nut receptacle with removable straight backshell for screen termination and heatshrink sleeving

Page 31

07P/RP



Jam nut receptacle with straight backshell for potting

Page 31

07T/RT



Jam nut receptacle with straight backshell for heatshrink sleeving

Page 32

07T/RT...38/42



Jam nut receptacle with removable backshell and heatshrink sleeving

Page 32

Solder fixing receptacle for hermetic version type IH

Front view



IH



Solder fixing receptacle not accepting backshell

Page 43

Plug type 06

Front view

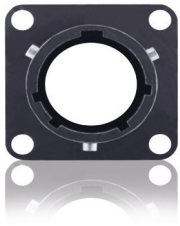

06J



Plug with straight sealing gland backshell
Page 34

06M/RM



Plug with removable straight backshell for heatshrink sleeving
Page 36

06P/RP



Plug with straight backshell for potting
Page 37

06Z/RZ



Plug with straight electrical pitch access
Page 39

36A/RA



Shielded plug with straight adaptor
Page 40

Plug overmolded



Refer to Eaton

06A/RA



Plug with straight adaptor
Page 33

06EC/RC



Plug with straight cable clamp
Page 33

06JC



Plug with straight sealing gland and cable clamp
Page 35

06NS*



Plug with short metallic adaptor and plastic cable gland with spiral protector
Page 36

06S*



Plug with short metallic adaptor and plastic cable gland
Page 38

08EC/RC



Plug with elbow cable clamp backshell
Page 39

36G/RG



Shielded plug with removable straight backshell for screen termination and heatshrink sleeving
Page 41

06AC



Plug with straight cable clamp without grommet
Page 33

06E/R



Plug with backnut
Page 34

06L*



Plug with long metallic adaptor and plastic cable gland
Page 35

06NL*



Plug with long metallic adaptor and plastic cable gland with spiral protector
Page 37

06T/RT



Plug with straight backshell for heatshrink sleeving
Page 38

08P/RP



Plug with elbow backshell for potting
Page 40

36T/RT...38/42



Shielded plug with removable straight backshell for screen termination and heatshrink sleeving
Page 41

Souriau 851 series

Ordering information

Environmental connectors

851 00 E 8 3A P - 50 --

Shell type

- 00:** Square flange receptacle accepting backshells
- 01:** In-line receptacle
- 02:** Square flange receptacle not accepting backshells
- 07:** Jam nut receptacle accepting backshells
- 06:** Plug for use with straight backshells
- 08:** Plug for use with 90° backshells
- 36:** Shielded plug for use with straight backshells

Specification (without specification: Olive green cadmium plating)

- 29:** Black anodized plating (solder type contacts)
- 031:** Black anodized plating (crimp type contacts)
- 44:** Nickel plating
- 66:** Crimp version: delivered without backshell and conical Solder version: delivered without backshell, conical ring and grommet

Backshell type

Solder Crimp

- | | | |
|-----------|-----------|--|
| A | RA | Straight adaptor |
| EC | RC | Straight cable clamp for solder contacts |
| EC | RC | 90° cable clamp |
| AC | | Straight cable clamp without grommet |
| E | R | Backnut |
| G | RG | Straight removable backshell for screen termination and heatshrink sleeving |
| J | | Straight backshell with sealing gland |
| JC | | Straight backshell with sealing gland and cable clamp |
| L | | Long metallic adaptor and plastic cable gland
Shell size 08 to 16 |
| M | RM | Square flange receptacle not accepting backshells |
| NL | | Long metallic adaptor and plastic cable gland with spiral protector - shell size 08 to 16 |
| NS | | Short metallic adaptor and plastic cable gland with spiral protector - shell size 08 to 16 |
| P | RP | Straight backshell for potting |
| P | RP | 90° backshell for potting |
| S | | Short metallic adaptor and plastic cable gland shell size 08 to 16 |
| T | RT | Straight backshell for heatshrink sleeving |
| U | RU | Short backshell for screen termination and heatshrink sleeving |
| Z | RZ | Straight adaptor for electrical pitch access |

Mandatory suffix

- B:** Crimp version without clip for layouts 8-2, 8-3, 8-4, & 12-14, gold plated all over the contact
- 50:** Cadmium plating (for contact details, see **Page 13**)
- 51:** Cadmium plating with gold plated contacts (for contact details, see **Page 13**)
- 54:** Black zinc nickel plating (for contact details, see **Page 13**)
- 57:** Black zinc nickel plating (for contact details, see **Page 13**)
- 62:**
 - Gray tin-zinc plating for receptacles
 - Gray tin-zinc plating with black anodized coupling ring for plugs (for contact details, see **Page 13**)

Orientation

Normal (not included in part number).
For others note: W, X, Y, Z - see table **Page 62**

Contact type

- P:** Male
- S:** Female

Shell size

8 - 10 - 12 - 14 - 16 - 18 - 20 - 22 - 24

Contacts layout

See **Pages 10 to 12**

Hermetic connectors

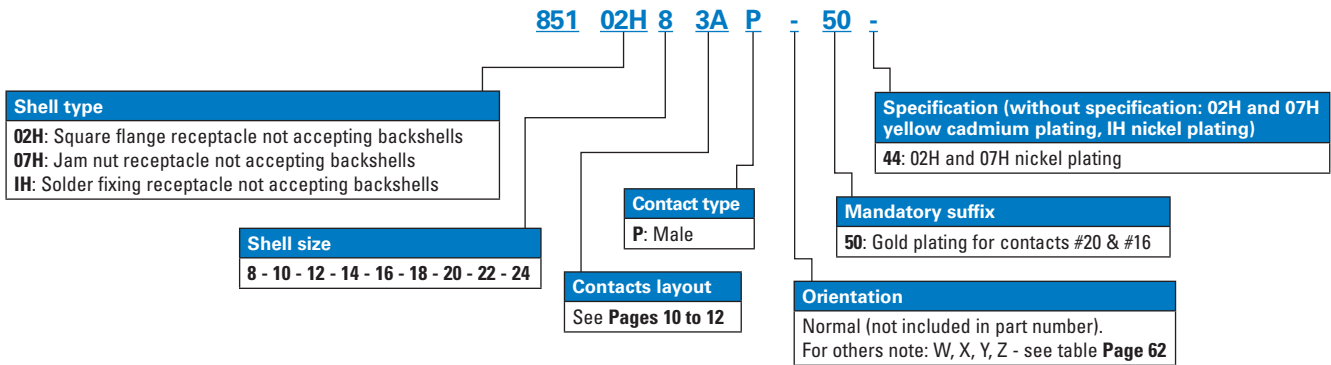

PC tail connectors

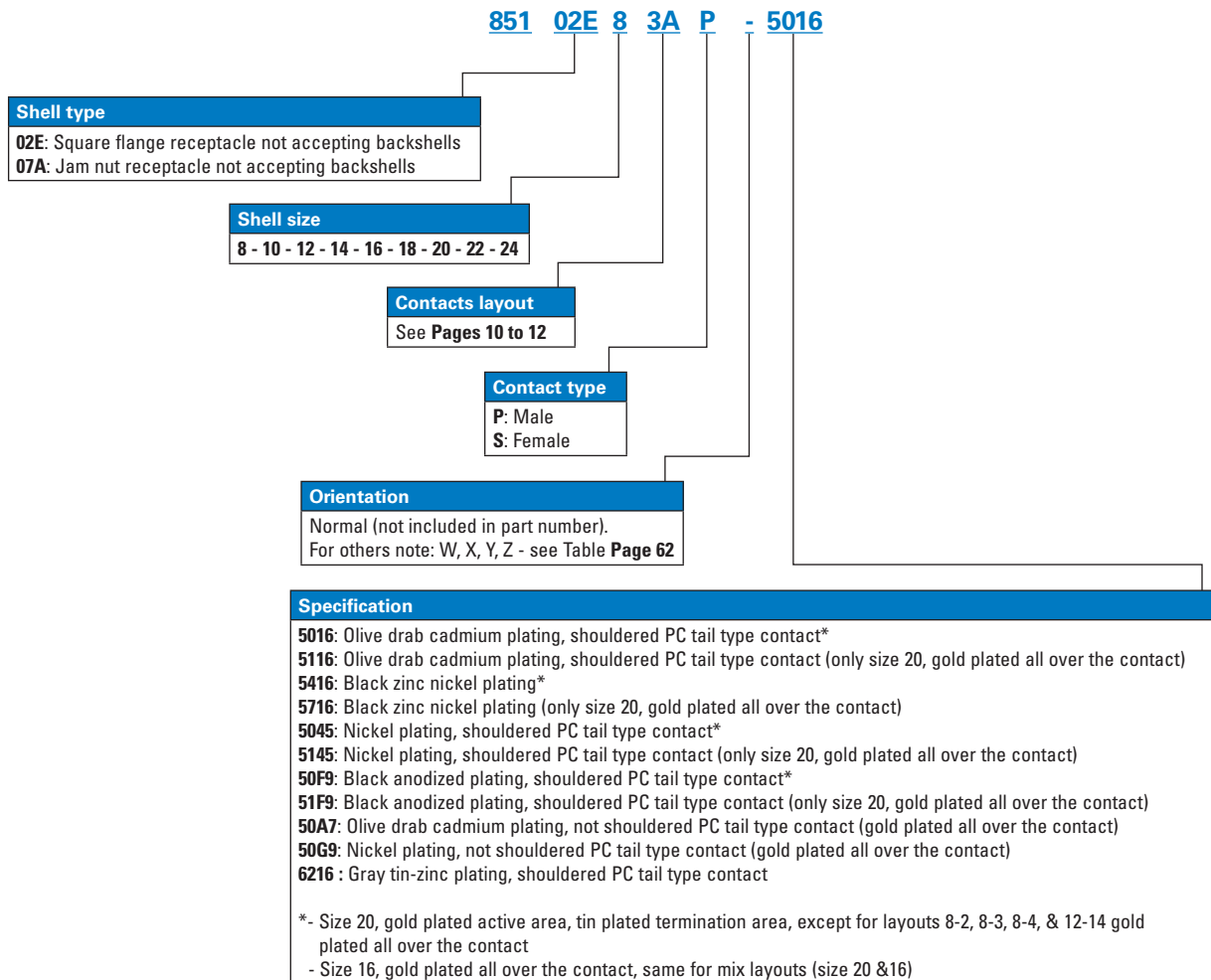

Souriau 851 series

Contact layouts

Contact layouts

Contact #16
(Ø 0.062" Ø 1.6 mm)

Contact #20
(Ø 0.039" Ø 1.0 mm)

Mixed power

Size 8

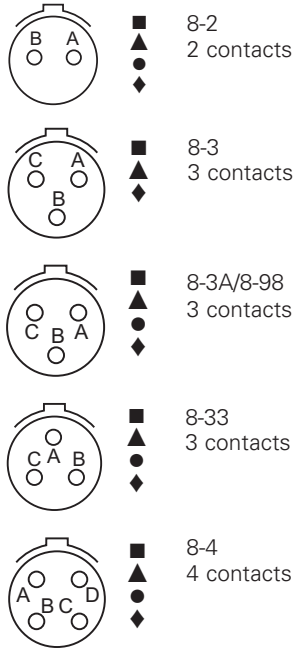

Size 10

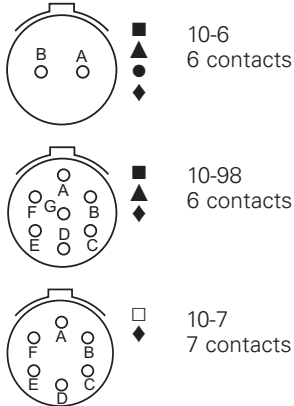

Size 12

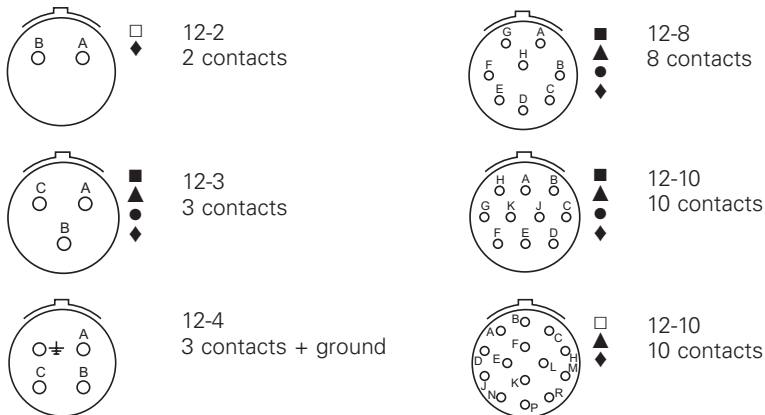

■ Solder contact layouts (QPL) □ Solder contact layouts + Solder contact layouts without grommet ▲ Crimp contact layouts ● Hermetic version contact layouts ◆ PC tail contact layouts

Contact layouts

Contact #16
(Ø 0.062" Ø 1.6 mm)

Contact #20
(Ø 0.039" Ø 1.0 mm)

Mixed power

Size 14

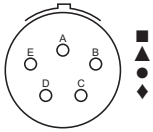

14-5
5 contacts

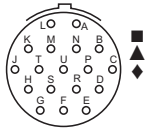

14-18
18 contacts

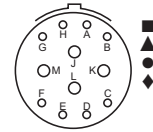

14-12
12 contacts
8 x #20 + 4 x #16

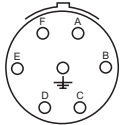

14-7
6 contacts + ground

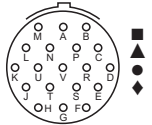

14-19
19 contacts

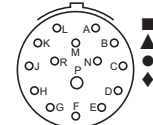

14-15
15 contacts
14 x #20 + 1 x #16

Size 16

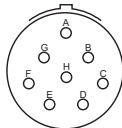

16-8
8 contacts

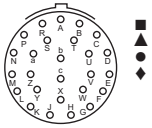

16-26
26 contacts

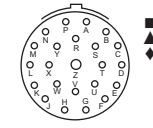

16-23
23 contacts
22 x #20 + 1 x #16

Size 18

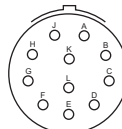

18-11
11 contacts

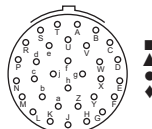

18-32
32 contacts

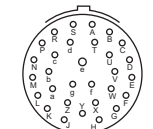

18-30
30 contacts
29 x #20 + 1 x #16

Size 20

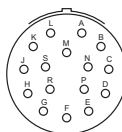

20-16
16 contacts

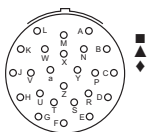

20-24
24 contacts

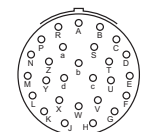

20-39
39 contacts
37 x #20 + 2 x #16

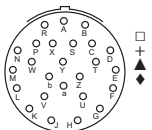

20-25
25 contacts

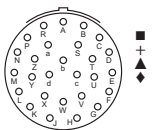

20-27
27 contacts
27xØ1.0 (#20)



20-41
41 contacts
41xØ 1.0 (#20)

■ Solder contact layouts (QPL) □ Solder contact layouts + Solder contact layouts without grommet ▲ Crimp contact layouts ● Hermetic version contact layouts ◆ PC tail contact layouts

Souriau 851 series

Contact layouts

Contact #16
(Ø 0.062" Ø 1.6 mm)

Contact #20
(Ø 0.039" Ø 1.0 mm)

Mixed power

Size 22

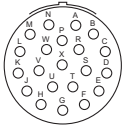

22-21
21 contacts
21xØ1.6 (#16)

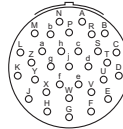

22-32
32 contacts
32xØ1.0 (#20)

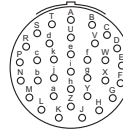

22-34
34 contacts
34xØ1.0 (#20)

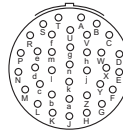

22-36
36 contacts
36xØ1.0 (#20)

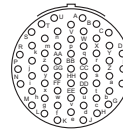

22-55
55 contacts
55xØ1.0 (#20)

Size 24

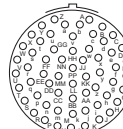

24-61
61 contacts
61xØ1.0 (#20)

Suffix description

Suffix	Description	Shell plating	Contact type	Active area contact plating	Termination area contact plating	RoHS	Salt spray
50	Cadmium version	Cadmium	Solder or Crimp	Crimp: Gold Solder: - # 20: Gold - # 16 & Mixed layouts: Gold	Crimp: Gold Solder: - # 20: Tin (1) - # 16 & Mixed layout: Gold	No	48 h
51	Cadmium version with full gold contacts (only for # 20 contacts)	Cadmium	Solder	# 20 only: Gold	# 20 only: Gold	No	48 h
54	Black zinc nickel version	Black zinc nickel	Solder or Crimp	Crimp: Gold Solder: - # 20: Gold - # 16 & Mixed layouts: Gold	Crimp: Gold Solder: - # 20: Tin (1) - # 16 & Mixed layout: Gold	Yes, except for contacts with tin	500 h
57	Black zinc nickel version with full gold contacts (only for # 20 contacts)	Black zinc nickel	Solder or Crimp	Crimp: Gold Solder: Gold	Crimp: Gold Solder: Gold	Yes	500 h
5044	Nickel version	Nickel	Solder or Crimp	Crimp: Gold Solder: - # 20: Gold - # 16 & Mixed layouts: Gold	Crimp: Gold Solder: - # 20: Tin (1) - # 16 & Mixed layout: Gold	Yes, except for contacts with tin	48 h
5029	Black anodized version for solder contacts (non-conductive shell)	Black Anodized	Solder or Crimp	- Size 20: Gold - Size 16 & Mixed layouts: Gold	- # 20: Tin (1) - # 16 & Mixed layout: Gold	Yes, except for contacts with tin	48 h
5031	Black anodized version for crimp contacts (non-conductive shell)	Black Anodized	Solder	# 20 only: Gold	# 20 only: Gold	Yes	48 h
5066	Cadmium without accessories Crimp: Without backshell and conical ring. Solder versions: Without Backshell, conical ring and grommet	Cadmium	Solder or Crimp	Crimp: Gold Solder: - # 20: Gold - # 16 & Mixed layouts: Gold	Crimp: Gold Solder: - # 20: Tin (1) - # 16 & Mixed layout: Gold	No	48 h
5466	Black zinc nickel without accessories Crimp: Without backshell and conical ring. Solder versions: Without backshell, conical ring and grommet	Black zinc nickel	Solder or Crimp	Crimp: Gold Solder: - # 20: Gold - # 16 & Mixed layouts: Gold	Crimp: Gold Solder: - # 20: Tin (1) - # 16 & Mixed layout: Gold	Yes, except for contacts with tin	500 h
5766	Black zinc nickel with full gold contacts (only for # 20 contacts) and without accessories Crimp: Without backshell and conical ring. Solder versions: Without backshell, conical ring and grommet	Black zinc nickel	Solder or Crimp	# 20 only: Gold	# 20 only: Gold	Yes	500 h
62	Gray tin-zinc	Receptacles: Gray tin-zinc Plugs: Gray tin-zinc+black anodized coupling ring	Solder or Crimp	Crimp: Gold Solder: - # 20: Gold - # 16 & Mixed layouts: Gold	Crimp: Gold Solder: - # 20: Tin (1) - # 16 & Mixed layouts: Gold	No	500h

Note: (1): Exception: Gold on layouts 8-2, 8-3, 8-4 & 12-4

Souriau 851 series

PC tail contacts

Suffix description

Suffix	Description	Shell plating	Contact type	Active area contact plating	Termination area contact plating	RoHS	Salt spray
5016	Cadmium version	Cadmium	Shouldered PC tail	- # 20: Gold - # 16 & Mixed layouts: Gold	- # 20: Tin (1) - # 16 & Mixed layout: Gold	No	48 h
5116	Cadmium version with full gold contacts (only for # 20 contacts)	Cadmium	Shouldered PC tail	Gold	Gold	No	48 h
5416	Black zinc nickel version	Black zinc nickel	Shouldered PC tail	- # 20: Gold - # 16 & Mixed layouts: Gold	- # 20: Tin (1) - # 16 & Mixed layout: Gold	Yes, except for contacts with tin	500 h
5716	Black zinc nickel version with full gold contacts (only for # 20 contacts)	Black zinc nickel	Shouldered PC tail	Gold	Gold	Yes	500 h
5045	Nickel version	Nickel	Shouldered PC tail	- # 20: Gold - # 16 & Mixed layouts: Gold	- # 20: Tin (1) - # 16 & Mixed layout: Gold	Yes, except for contacts with tin	48 h
5145	Nickel version with full gold contacts (only for # 20 contacts)	Nickel	Shouldered PC tail	Gold	Gold	Yes	48 h
50F9	Black anodized version (non-conductive shell)	Black Anodized	Shouldered PC tail	- # 20: Gold - # 16 & Mixed layouts: Gold	- # 20: Tin (1) - # 16 & Mixed layout: Gold	Yes, except for contacts with tin	48 h
51F9	Black anodized version (non-conductive shell) with full gold contacts (only for # 20 contacts)	Black Anodized	Shouldered PC tail	Gold	Gold	Yes	48 h
50A7	Cadmium version not shouldered PC tail	Cadmium	Not shouldered PC tail	- # 20: Gold - # 16 & Mixed layouts: Gold	- # 20: Tin (1) - # 16 & Mixed layout: Gold	No	48 h
50G9	Nickel version not shouldered PC tail	Nickel	Not shouldered PC tail	- # 20: Gold - # 16 & Mixed layouts: Gold	- # 20: Tin (1) - # 16 & Mixed layout: Gold	Yes, except for contacts with tin	48 h
6216	Gray tin-zinc	Receptacles: Gray tin-zinc Plugs: Gray tin-zinc + black anodized coupling ring	Solder or Crimp	Crimp: Gold Solder: - # 20: Gold - # 16 & Mixed layouts: Gold	Crimp: Gold Solder: - # 20: Tin (1) - # 16 & Mixed layouts: Gold	No	500h

Note: (1): Exception: Gold on layouts 8-2, 8-3, 8-4 & 12-4

Shouldered PC tail contacts

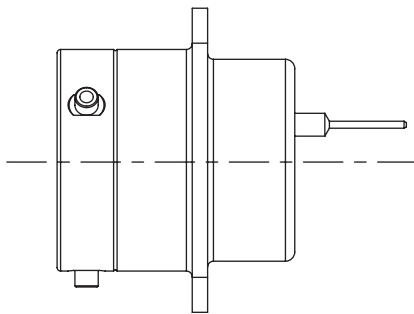

Not shouldered PC tail contacts

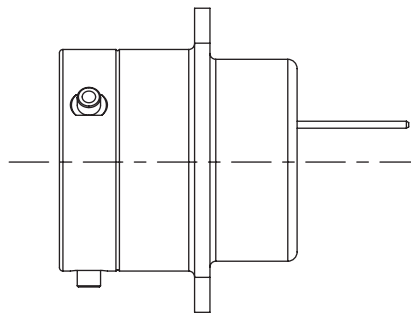

851 version with crimp contacts (olive green cadmium plating)

Connector with backshells

Souriau series	NCF 93422 (model HE 301B)	MIL-DTL-26482G Series I	VG 95328
851 00 R	HE 301 B 00 R	* MS 3120 E	VG 95328 A
851 00 RC	HE 301 B 00 RC	* MS 3120 F	VG 95328 B
851 00 RP	HE 301 B 00 RP	* MS 3120 P	–
851 00 RG	–	–	VG 95328 R
851 00 RA	HE 301 B 00 RA	–	–
851 01 R	HE 301 B 01 R	* MS 3121 E	–
851 01 RC	HE 301 B 01 RC	* MS 3121 F	–
851 01 RP	HE 301 B 01 RP	* MS 3121 P	–
851 01 RA	HE 301 B 01 RA	–	–
851 02 R	HE 301 B 02 R	* MS 3122 E	VG 95328 C
851 06 R	HE 301 B 06 R	* MS 3126 E	–
851 06 RC	HE 301 B 06 RC	* MS 3126 F	VG 95328 K
851 06 RP	HE 301 B 06 RP	* MS 3126 P	–
851 06 RT	–	–	VG 95328 J
851 06 RA	HE 301 B 06 RA	–	–
851 36 RG	–	–	VG 95328 M
851 36 RA	–	–	–
851 07 R	HE 301 B 07 R	* MS 3124 E	VG 95328 D
851 07 RC	HE 301 B 07 RC	* MS 3124 F	VG 95328 E
851 07 RP	HE 301 B 07 RP	* MS 3124 P	–
851 07 RT	–	–	VG 95328 S
851 07 RG	–	–	VG 95328 T
851 08 RC	HE 301 B 08 RC	–	–

Note: * Not QPL

851 version with crimp contacts (other plating)

Plating	Souriau Solder version	Crimp version	NCF 93422 (model HE 301B)
Black anodized	851	851	HE 301B
Nickel	851	851	HE 301B

Souriau 851 series

PC tail contacts

851 version with solder contacts (olive green cadmium plating)

Connector with backshells

SOURIAU series	NCF 93422 (model HE 301B)	MIL-DTL-26482G Series I	VG 95328
851 00 E 50 ..	HE 301 B 00 E 1A	MS 3110 E	–
851 00 EC 50 ..	HE 301 B 00 EC 1A	MS 3110 F	–
851 00 AC 50 ..	HE 301 B 00 AC 1A	–	–
851 00 P 50 ..	HE 301 B 00 P 1A	MS 3110 P	–
851 00 A 50 ..	HE 301 B 00 A 1A	–	–
851 00 J 50 ..	HE 301 B 00 J 1A	–	–
851 00 JC 50 ..	–	MS 3110 J	–
851 01 E 50 ..	HE 301 B 01 E 1A	MS 3111 E	–
851 01 EC 50 ..	HE 301 B 01 EC 1A	MS 3111 F	–
851 01 AC 50 ..	HE 301 B 01 AC 1A	–	–
851 01 P 50 ..	HE 301 B 01 P 1A	MS 3111 P	–
851 01 A 50 ..	HE 301 B 01 A 1A	–	–
851 01 J 50 ..	HE 301 B 01 J 1A	–	–
851 01 JC 50 ..	–	MS 3111 J	–
851 02 E 50 ..	HE 301 B 02 E 1A	MS 3112 E	VG 95328 H
851 06 E 50 ..	HE 301 B 06 E 1A	MS 3116 E	–
851 06 EC 50 ..	HE 301 B 06 EC 1A	MS 3116 F	–
851 06 AC 50 ..	HE 301 B 06 AC 1A	–	–
851 06 P 50 ..	HE 301 B 06 P 1A	MS 3116 P	–
851 06 A 50 ..	HE 301 B 06 A 1A	–	–
851 06 J 50 ..	HE 301 B 06 J 1A	–	–
851 06 JC 50 ..	–	MS 3116 J	–
851 08 EC 50 ..	HE 301 B 08 EC 1A	–	–
851 08 P 50 ..	HE 301 B 08 P 1A	–	–
851 07 E 50 ..	HE 301 B 07 E 1A	MS 3114 E	–
851 07 EC 50 ..	HE 301 B 07 EC 1A	MS 3114 F	–
851 07 AC 50 ..	HE 301 B 07 AC 1A	–	–
851 07 P 50 ..	HE 301 B 07 P 1A	MS 3114 P	–

851 hermetic version

Souriau series	NFC 93422 (model HE 301B)	MIL-DTL-26482G Series I	VG 95328
851 02 H P.50	HE 301 B 02 H P.3A		
851 07 H P.50	HE 301 B 07 H P.3A	* MS 3114 H P.	VG 95328 F
851 1 H P.50	HE 301 B 1 H P.3A	* MS 3113 H P.	VG 95328 G

Note: * Not QPL



Technical specifications

Materials

Shell

- Environmental version
 - Aluminum alloy
- Plating
 - Olive green cadmium
 - Black anodized
 - Black zinc nickel
 - Nickel
 - Gray tin-zinc

Backshells

Aluminum alloy

Cable glands

Thermoplastic

Coupling ring

Aluminum alloy

Spring washer

Spring stainless steel

Insert

Elastomeric soft neoprene

RoHS compliant and conforms to the Chinese standard SJ/T1166-2006 (Chinese RoHS equivalent)

Mechanical

Durability

500 mating cycles, in accordance with MIL-DTL-26482 H

Mechanical shock

50 g, 11 ms period per EIA-364-27

Electrical

Dielectric withstanding voltage

- Mated and unmated connectors at standard pressure:
 - 1500 Vrms between size 20 contacts (service 1)
 - 2300 Vrms between size 16 contacts (service 2)
 - 1500 Vrms between mixed size 20 and 16 contacts (service 1)
- Mated and unmated connectors at reduce pressure, 10 mbar:
 - 200 Vrms between size 20 contacts (service 1)
 - 300 Vrms between size 16 contacts (service 2)

Insulation resistance

≥ 5000 MΩ under 500 Vcc

Current rating per contact

- Standard version
 - Size 20 = 7.5 A
 - Size 16 = 13 A
- Hermetic version
 - Size 20 = 5 A
 - Size 16 = 10 A

Contact resistance

- Environmental version
 - Size 20 ≤ 4 mΩ
 - Size 16 ≤ 3 mΩ
- Hermetic version
 - Size 20 ≤ 30 mΩ
 - Size 16 ≤ 14 mΩ
- Shielding effectiveness
 - 70 dB to 5 MHz
 - 40 dB to 100 MHz

Environmental

Operating temperature

From -55°C to +125°C

Flammability rating

UL94 HB

Dynamic salt spray according to EIA-364-26

- Cadmium, nickel, zinc cobalt - 48 hr
- Black anodized - 500 hr
- Black zinc nickel - 500 hr
- Gray tin-zinc - 500 hr

Sealing

- Globally IP65 (unmated conditions)
- With J or JC backshell IP67 (mated conditions)
- With cable gland IP68 (mated conditions)
- Crimp contact version, 1 bar differential pressure, leakage = 8 cm³/hr
- Solder contact version, 2 bar differential pressure, leakage = 16 cm³/hr

Fluid resistance

- According to MIL-DTL-26482 G Series I and NFC 93422 - HE 301 B Code A
- Hydraulic fluids
- Lubricating oil

Souriau 851 series

Hermetic versions

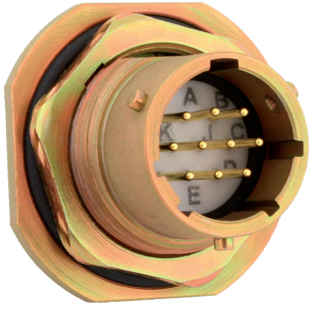

Technical specifications

Materials

Shell

- Steel

Plating

- Iridescent yellow cadmium
- Nickel

Contact:

- Gold plated ferrous alloy

Seal

- Fluorocarbon elastomer

Electrical

Max current rating per contact:

- Contact size 20 rating (A) = 5
- Contact size 16 rating (A) = 10

Dielectric withstanding voltage:

- **Service I**
 - Standard pressure
1 500 Vrms
 - 10 mbar pressure
200 Vrms
- **Service II**
 - Standard pressure
2.300 Vrms
 - 10 mbar pressure
300 Vrms
- **Contact resistance**
 - Size 20 $\leq 30 \text{ m}\Omega$
 - Size 16 $\leq 14 \text{ m}\Omega$
- **Shielding**
 - 70 dB to 5 MHz
 - 40 dB to 100 MHz

Environmental

Operating temperature

- -55°C to $+125^{\circ}\text{C}$

Hermeticity

- 1 bar differential pressure,
leakage $\leq 2.8 \text{ mm}^3/\text{hr}$

Salt spray

- 48 hours min

Chemical resistance

- According to MIL-DTL-26482 G
Series I

Damp heat

- 21 days

Square flange receptacle with straight adaptor

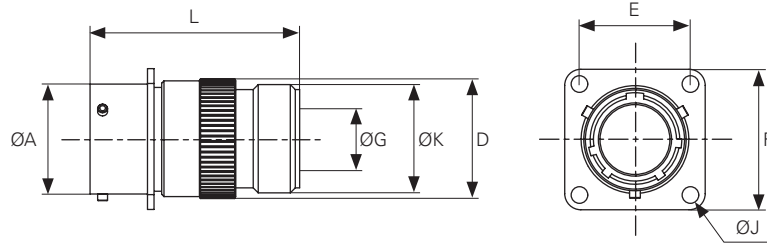

Cross reference

00 A	HE 301 B 00 A
00 RA	HE 301 B 00 RA

Shell size	Part numbers solder contacts	Part numbers crimp contacts	L max solder	L max crimp	Ø A	B max	C max	Ø D max	E	F max	Ø G max	Ø J	K threading UNEF 2A
8	851 00 A 8.. P S . 50..	851 00 RA 8.. P S . 50..	1.614 (41.00)	1.614 (41.00)	0.473 (12.03)	0.451 (11.70)	0.051 (1.32)	0.570 (14.50)	0.594 (15.09)	0.826 (20.99)	0.358 (9.10)	0.123 (3.13)	1/2 18
10	851 00 A 10.. P S . 50..	851 00 RA 10.. P S . 50..	1.614 (41.00)	1.614 (41.00)	0.590 (15.01)	0.451 (11.70)	0.051 (1.32)	0.736 (18.70)	0.718 (18.26)	0.952 (24.19)	0.475 (12.08)	0.123 (3.13)	5/8 24
12	851 00 A 12.. P S . 50..	851 00 RA 12.. P S . 50..	1.614 (41.00)	1.614 (41.00)	0.750 (19.07)	0.451 (11.70)	0.051 (1.32)	0.854 (21.70)	0.811 (20.62)	1.044 (26.54)	0.600 (15.25)	0.123 (3.13)	3/4 20
14	851 00 A 14.. P S . 50..	851 00 RA 14.. P S . 50..	1.614 (41.00)	1.614 (41.00)	0.876 (22.25)	0.451 (11.70)	0.051 (1.32)	0.988 (25.10)	0.905 (23.00)	1.137 (28.89)	0.714 (18.15)	0.123 (3.13)	7/8 20
16	851 00 A 16.. P S . 50..	851 00 RA 16.. P S . 50..	1.614 (41.00)	1.614 (41.00)	1.000 (25.42)	0.451 (11.70)	0.051 (1.32)	1.107 (28.13)	0.968 (24.61)	1.231 (31.29)	0.839 (21.32)	0.123 (3.13)	1-20
18	851 00 A 18.. P S . 50..	851 00 RA 18.. P S . 50..	1.614 (41.00)	1.614 (41.00)	1.126 (28.60)	0.451 (11.70)	0.051 (1.32)	1.235 (31.38)	1.061 (26.97)	1.326 (33.69)	0.957 (24.32)	0.123 (3.13)	1-3/16 18
20	851 00 A 20.. P S . 50..	851 00 RA 20.. P S . 50..	1.732 (44.00)	1.732 (44.00)	1.250 (31.77)	0.565 (14.35)	0.084 (2.15)	1.350 (34.30)	1.156 (29.36)	1.452 (36.89)	1.052 (26.73)	0.123 (3.13)	1-3/16 18
22	851 00 A 22.. P S . 50..	851 00 RA 22.. P S . 50..	1.732 (44.00)	1.732 (44.00)	1.376 (34.95)	0.565 (14.35)	0.084 (2.15)	1.480 (37.60)	1.250 (31.75)	1.574 (39.99)	1.207 (30.67)	0.123 (3.13)	1-7/16 18
24	851 00 A 24.. P S . 50..	851 00 RA 24.. P S . 50..	1.732 (44.00)	1.732 (44.00)	1.500 (38.12)	0.598 (15.20)	0.084 (2.15)	1.602 (40.70)	1.374 (34.92)	1.698 (43.15)	1.302 (33.08)	0.150 (3.81)	1-7/16 18

Square flange receptacle with straight cable clamp

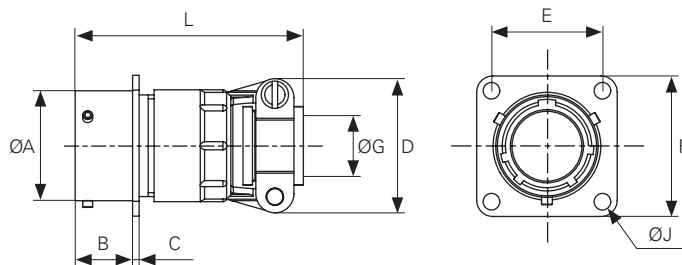

Cross reference

00 EC	HE 301 B 00 EC
	MS 3110 F
00 AC	HE 301 B 00 AC
	HE 301 B 00 RC
00 RC	MS 3120 F
	VG 95328 B

Shell size	Part numbers solder contacts	Part numbers crimp contacts	L max solder	L max crimp	Ø A	B max	C max	Ø D max	E	F max	Ø G max	Ø J
8	851 00 EC AC 8.. P S . 50..	851 00 RC 8.. P S . 50..	1.889 (48.00)	1.862 (47.30)	0.473 (12.03)	0.451 (11.70)	0.051 (1.32)	0.531 (13.50)	0.594 (15.09)	0.826 (20.99)	0.137 (3.50)	0.123 (3.13)
10	851 00 EC AC 10.. P S . 50..	851 00 RC 10.. P S . 50..	1.889 (48.00)	1.862 (47.30)	0.590 (15.01)	0.451 (11.70)	0.051 (1.32)	0.657 (16.70)	0.718 (18.26)	0.952 (24.19)	0.196 (5.00)	0.123 (3.13)
12	851 00 EC AC 12.. P S . 50..	851 00 RC 12.. P S . 50..	1.889 (48.00)	1.862 (47.30)	0.750 (19.07)	0.451 (11.70)	0.051 (1.32)	0.783 (19.90)	0.811 (20.62)	1.044 (26.54)	0.322 (8.20)	0.123 (3.13)
14	851 00 EC AC 14.. P S . 50..	851 00 RC 14.. P S . 50..	1.889 (48.00)	1.862 (47.30)	0.876 (22.25)	0.451 (11.70)	0.051 (1.32)	0.921 (23.40)	0.905 (23.00)	1.137 (28.89)	0.393 (10.00)	0.123 (3.13)
16	851 00 EC AC 16.. P S . 50..	851 00 RC 16.. P S . 50..	2.007 (51.00)	1.988 (50.50)	1.000 (25.42)	0.451 (11.70)	0.051 (1.32)	1.047 (26.60)	0.968 (24.61)	1.231 (31.29)	0.511 (13.00)	0.123 (3.13)
18	851 00 EC AC 18.. P S . 50..	851 00 RC 18.. P S . 50..	2.007 (51.00)	1.988 (50.50)	1.126 (28.60)	0.451 (11.70)	0.051 (1.32)	1.161 (29.50)	1.061 (26.97)	1.326 (33.69)	0.629 (16.00)	0.123 (3.13)
20	851 00 EC AC 20.. P S . 50..	851 00 RC 20.. P S . 50..	2.086 (53.00)	2.027 (51.50)	1.250 (31.77)	0.565 (14.35)	0.084 (2.15)	1.287 (32.70)	1.156 (29.36)	1.452 (36.89)	0.629 (16.00)	0.123 (3.13)
22	851 00 EC AC 22.. P S . 50..	851 00 RC 22.. P S . 50..	2.086 (53.00)	2.027 (51.50)	1.376 (34.95)	0.565 (14.35)	0.084 (2.15)	1.417 (36.00)	1.250 (31.75)	1.574 (39.99)	0.759 (19.30)	0.123 (3.13)
24	851 00 EC AC 24.. P S . 50..	851 00 RC 24.. P S . 50..	2.086 (53.00)	2.027 (51.50)	1.500 (38.12)	0.598 (15.20)	0.084 (2.15)	1.539 (39.10)	1.374 (34.92)	1.698 (43.15)	0.811 (20.60)	0.150 (3.81)

Dimensions are in inches (millimeters)

Souriau 851 series

Hermetic versions

Square flange receptacle with straight adaptor

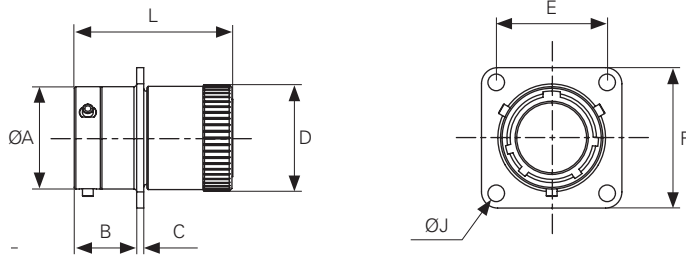

Cross reference

00 E	HE 301 B 00 E
	MS 3110 E
00 R	HE 301 B 00 R
	MS 3120 E
	VG 95328 A

Shell size	Part numbers		L max		Ø A	B max	C max	Ø D max	E	F max	Ø J
	solder contacts	crimp contacts	solder	crimp							
8	851 00 E 8.. ^P _s . 50..	851 00 R 8.. ^P _s . 50..	1.287 (32.70)	1.259 (32.00)	0.473 (12.03)	0.451 (11.70)	0.051 (1.32)	0.531 (13.50)	0.594 (15.09)	0.826 (20.99)	0.123 (3.13)
10	851 00 E 10.. ^P _s . 50..	851 00 R 10.. ^P _s . 50..	1.287 (32.70)	1.259 (32.00)	0.590 (15.01)	0.451 (11.70)	0.051 (1.32)	0.657 (16.70)	0.718 (18.26)	0.952 (24.19)	0.123 (3.13)
12	851 00 E 12.. ^P _s . 50..	851 00 R 12.. ^P _s . 50..	1.287 (32.70)	1.259 (32.00)	0.750 (19.07)	0.451 (11.70)	0.051 (1.32)	0.783 (19.90)	0.811 (20.62)	1.044 (26.54)	0.123 (3.13)
14	851 00 E 14.. ^P _s . 50..	851 00 R 14.. ^P _s . 50..	1.287 (32.70)	1.259 (32.00)	0.876 (22.25)	0.451 (11.70)	0.051 (1.32)	0.921 (23.40)	0.905 (23.00)	1.137 (28.89)	0.123 (3.13)
16	851 00 E 16.. ^P _s . 50..	851 00 R 16.. ^P _s . 50..	1.287 (32.70)	1.259 (32.00)	1.000 (25.42)	0.451 (11.70)	0.051 (1.32)	1.047 (26.60)	0.968 (24.61)	1.231 (31.29)	0.123 (3.13)
18	851 00 E 18.. ^P _s . 50..	851 00 R 18.. ^P _s . 50..	1.287 (32.70)	1.259 (32.00)	1.126 (28.60)	0.451 (11.70)	0.051 (1.32)	1.161 (29.50)	1.061 (26.97)	1.326 (33.69)	0.123 (3.13)
20	851 00 E 20.. ^P _s . 50..	851 00 R 20.. ^P _s . 50..	1.358 (34.50)	1.315 (33.40)	1.250 (31.77)	0.565 (14.35)	0.084 (2.15)	1.287 (32.70)	1.156 (29.36)	1.452 (36.89)	0.123 (3.13)
22	851 00 E 22.. ^P _s . 50..	851 00 R 22.. ^P _s . 50..	1.358 (34.50)	1.315 (33.40)	1.376 (34.95)	0.565 (14.35)	0.084 (2.15)	1.417 (36.00)	1.250 (31.75)	1.574 (39.99)	0.123 (3.13)
24	851 00 E 24.. ^P _s . 50..	851 00 R 24.. ^P _s . 50..	1.358 (34.50)	1.315 (33.40)	1.500 (38.12)	0.598 (15.20)	0.084 (2.15)	1.539 (39.10)	1.374 (34.92)	1.698 (43.15)	0.150 (3.81)

Square flange receptacle with removable straight backshell for screen termination and heatshrink sleeving

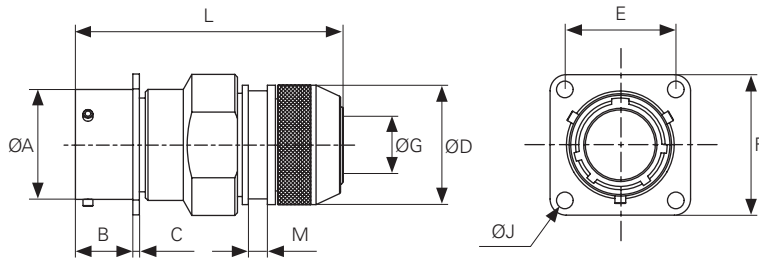

Cross reference

00 G	
00 RG	VG 95328 R

Shell size	Part numbers		L max		Ø A	B max	C max	Ø D max	E	F max	Ø G max	Ø J	M max
	solder contacts	crimp contacts	solder	crimp									
8	851 00 ^{EC} _{Ac} 8.. ^P _s . 50..	851 00 RC 8.. ^P _s . 50..	2.126 (54.00)	2.126 (54.00)	0.473 (12.03)	0.451 (11.70)	0.051 (1.32)	0.641 (16.30)	0.594 (15.09)	0.826 (20.99)	0.293 (7.45)	0.123 (3.13)	0.141 (3.60)
10	851 00 ^{EC} _{Ac} 10.. ^P _s . 50..	851 00 RC 10.. ^P _s . 50..	2.126 (54.00)	2.126 (54.00)	0.590 (15.01)	0.451 (11.70)	0.051 (1.32)	0.720 (18.30)	0.718 (18.26)	0.952 (24.19)	0.405 (10.30)	0.123 (3.13)	0.141 (3.60)
12	851 00 ^{EC} _{Ac} 12.. ^P _s . 50..	851 00 RC 12.. ^P _s . 50..	2.126 (54.00)	2.126 (54.00)	0.750 (19.07)	0.451 (11.70)	0.051 (1.32)	0.878 (22.30)	0.811 (20.62)	1.044 (26.54)	0.519 (13.20)	0.123 (3.13)	0.141 (3.60)
14	851 00 ^{EC} _{Ac} 14.. ^P _s . 50..	851 00 RC 14.. ^P _s . 50..	2.126 (54.00)	2.126 (54.00)	0.876 (22.25)	0.451 (11.70)	0.051 (1.32)	0.996 (25.30)	0.905 (23.00)	1.137 (28.89)	0.649 (16.50)	0.123 (3.13)	0.141 (3.60)
16	851 00 ^{EC} _{Ac} 16.. ^P _s . 50..	851 00 RC 16.. ^P _s . 50..	2.126 (54.00)	2.126 (54.00)	1.000 (25.42)	0.451 (11.70)	0.051 (1.32)	1.114 (28.30)	0.968 (24.61)	1.231 (31.29)	0.761 (19.35)	0.123 (3.13)	0.141 (3.60)
18	851 00 ^{EC} _{Ac} 18.. ^P _s . 50..	851 00 RC 18.. ^P _s . 50..	2.126 (54.00)	2.126 (54.00)	1.126 (28.60)	0.451 (11.70)	0.051 (1.32)	1.271 (32.30)	1.061 (26.97)	1.326 (33.69)	0.850 (21.60)	0.123 (3.13)	0.141 (3.60)
20	851 00 ^{EC} _{Ac} 20.. ^P _s . 50..	851 00 RC 20.. ^P _s . 50..	2.334 (59.30)	2.334 (59.30)	1.250 (31.77)	0.565 (14.35)	0.084 (2.15)	1.350 (34.30)	1.156 (29.36)	1.452 (36.89)	0.976 (24.80)	0.123 (3.13)	0.141 (3.60)
22	851 00 ^{EC} _{Ac} 22.. ^P _s . 50..	851 00 RC 22.. ^P _s . 50..	2.334 (59.30)	2.334 (59.30)	1.376 (34.95)	0.565 (14.35)	0.084 (2.15)	1.507 (38.30)	1.250 (31.75)	1.574 (39.99)	1.098 (27.90)	0.123 (3.13)	0.141 (3.60)
24	851 00 ^{EC} _{Ac} 24.. ^P _s . 50..	851 00 RC 24.. ^P _s . 50..	2.334 (59.30)	2.334 (59.30)	1.500 (38.12)	0.598 (15.20)	0.084 (2.15)	1.626 (41.30)	1.374 (34.92)	1.698 (43.15)	1.220 (31.00)	0.150 (3.81)	0.141 (3.60)

Dimensions are in inches (millimeters)

Square flange receptacle with straight sealing gland backshell

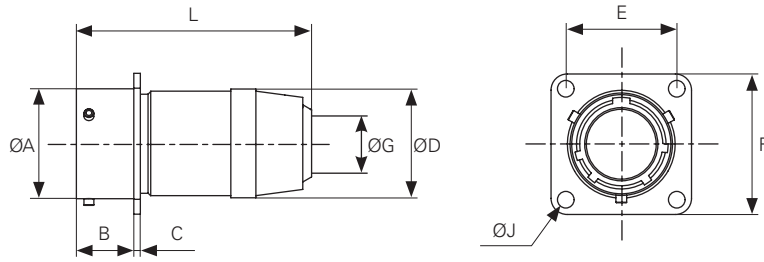

Cross reference

00 J	HE 301 B 00J
------	--------------

Shell size	Part numbers		L max		Ø A	B max	C max	Ø D max	E	F max	Ø G		Ø J
	solder contacts	crimp contacts	solder	crimp							min	max	
8	851 00 J 8.. P S . 50..	—	1.614 (41.00)	—	0.473 (12.03)	0.451 (11.70)	0.051 (1.32)	0.567 (14.40)	0.594 (15.09)	0.826 (20.99)	0.197 (5.02)	0.230 (5.84)	0.123 (3.13)
10	851 00 J 10.. P S . 50..	—	1.614 (41.00)	—	0.590 (15.01)	0.451 (11.70)	0.051 (1.32)	0.693 (17.60)	0.718 (18.26)	0.952 (24.19)	0.233 (5.94)	0.266 (6.76)	0.123 (3.13)
12	851 00 J 12.. P S . 50..	—	1.614 (41.00)	—	0.750 (19.07)	0.451 (11.70)	0.051 (1.32)	0.830 (21.10)	0.811 (20.62)	1.044 (26.54)	0.367 (9.34)	0.400 (10.16)	0.123 (3.13)
14	851 00 J 14.. P S . 50..	—	1.614 (41.00)	—	0.876 (22.25)	0.451 (11.70)	0.051 (1.32)	0.960 (24.40)	0.905 (23.00)	1.137 (28.89)	0.445 (11.32)	0.478 (12.14)	0.123 (3.13)
16	851 00 J 16.. P S . 50..	—	1.614 (41.00)	—	1.000 (25.42)	0.451 (11.70)	0.051 (1.32)	1.086 (27.60)	0.968 (24.61)	1.231 (31.29)	0.578 (14.73)	0.612 (15.55)	0.123 (3.13)
18	851 00 J 18.. P S . 50..	—	1.614 (41.00)	—	1.126 (28.60)	0.451 (11.70)	0.051 (1.32)	1.212 (30.80)	1.061 (26.97)	1.326 (33.69)	0.629 (16.00)	0.662 (16.82)	0.123 (3.13)
20	851 00 J 20.. P S . 50..	—	1.732 (44.00)	—	1.250 (31.77)	0.565 (14.35)	0.084 (2.15)	1.342 (34.10)	1.156 (29.36)	1.452 (36.89)	0.665 (16.89)	0.696 (17.70)	0.123 (3.13)
22	851 00 J 22.. P S . 50..	—	1.732 (44.00)	—	1.376 (34.95)	0.565 (14.35)	0.084 (2.15)	1.468 (37.30)	1.250 (31.75)	1.574 (39.99)	0.700 (17.78)	0.732 (18.60)	0.123 (3.13)
24	851 00 J 24.. P S . 50..	—	1.732 (44.00)	—	1.500 (38.12)	0.598 (15.20)	0.084 (2.15)	1.594 (40.50)	1.374 (34.92)	1.698 (43.15)	0.800 (20.34)	0.833 (21.16)	0.150 (3.81)

Square flange receptacle with straight sealing gland and cable clamp

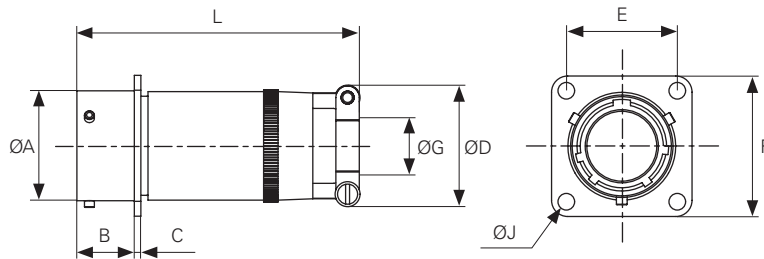

Cross reference

00 JC	MS 3110 J
-------	-----------

Shell size	Part numbers		L max		Ø A	B max	C max	Ø D max	E	F max	Ø G		Ø J
	solder contacts	crimp contacts	solder	crimp							min	max	
8	851 00 JC 8.. P S . 50..	—	2.270 (57.68)	—	0.473 (12.03)	0.451 (11.70)	0.051 (1.32)	0.783 (19.90)	0.594 (15.09)	0.826 (20.99)	0.197 (5.02)	0.230 (5.84)	0.123 (3.13)
10	851 00 JC 10.. P S . 50..	—	2.270 (57.68)	—	0.590 (15.01)	0.451 (11.70)	0.051 (1.32)	0.846 (21.50)	0.718 (18.26)	0.952 (24.19)	0.233 (5.94)	0.266 (6.76)	0.123 (3.13)
12	851 00 JC 12.. P S . 50..	—	2.411 (61.24)	—	0.750 (19.07)	0.451 (11.70)	0.051 (1.32)	0.984 (25.00)	0.811 (20.62)	1.044 (26.54)	0.367 (9.34)	0.400 (10.16)	0.123 (3.13)
14	851 00 JC 14.. P S . 50..	—	2.598 (66.01)	—	0.876 (22.25)	0.451 (11.70)	0.051 (1.32)	1.094 (27.80)	0.905 (23.00)	1.137 (28.89)	0.445 (11.32)	0.478 (12.14)	0.123 (3.13)
16	851 00 JC 16.. P S . 50..	—	2.943 (74.75)	—	1.000 (25.42)	0.451 (11.70)	0.051 (1.32)	1.157 (29.40)	0.968 (24.61)	1.231 (31.29)	0.578 (14.73)	0.612 (15.55)	0.123 (3.13)
18	851 00 JC 18.. P S . 50..	—	3.172 (80.57)	—	1.126 (28.60)	0.451 (11.70)	0.051 (1.32)	1.389 (35.30)	1.061 (26.97)	1.326 (33.69)	0.629 (16.00)	0.662 (16.82)	0.123 (3.13)
20	851 00 JC 20.. P S . 50..	—	3.609 (91.69)	—	1.250 (31.77)	0.565 (14.35)	0.084 (2.15)	1.389 (35.30)	1.156 (29.36)	1.452 (36.89)	0.665 (16.89)	0.696 (17.70)	0.123 (3.13)
22	851 00 JC 22.. P S . 50..	—	3.766 (95.66)	—	1.376 (34.95)	0.565 (14.35)	0.084 (2.15)	1.618 (41.10)	1.250 (31.75)	1.574 (39.99)	0.700 (17.78)	0.732 (18.60)	0.123 (3.13)
24	851 00 JC 24.. P S . 50..	—	3.985 (101.22)	—	1.500 (38.12)	0.598 (15.20)	0.084 (2.15)	1.669 (42.40)	1.374 (34.92)	1.698 (43.15)	0.800 (20.34)	0.833 (21.16)	0.150 (3.81)

Dimensions are in inches (millimeters)

Souriau 851 series

Hermetic versions

Square flange receptacle with removable straight backshell for heatshrink sleeving

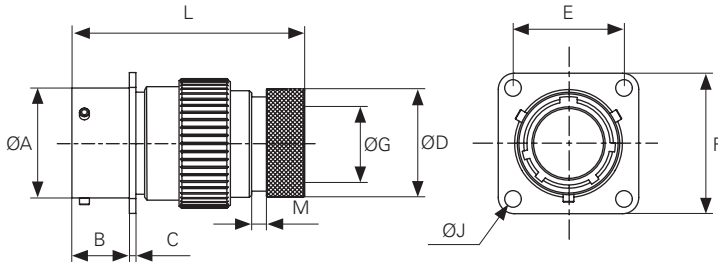

Shell size	Part numbers		L max		Ø A	B max	C max	Ø D max	E	F max	Ø G max	Ø J	M max
	solder contacts	crimp contacts	solder	crimp									
8	851 00 M 8.. P s . 50..	851 00 RM 8.. P s . 50..	1.668 (50.00)	1.668 (50.00)	0.473 (12.03)	0.451 (11.70)	0.051 (1.32)	0.533 (13.55)	0.594 (15.09)	0.826 (20.99)	0.277 (7.05)	0.123 (3.13)	0.137 (3.50)
10	851 00 M 10.. P s . 50..	851 00 RM 10.. P s . 50..	1.668 (50.00)	1.668 (50.00)	0.590 (15.01)	0.451 (11.70)	0.051 (1.32)	0.604 (15.35)	0.718 (18.26)	0.952 (24.19)	0.389 (9.90)	0.123 (3.13)	0.137 (3.50)
12	851 00 M 12.. P s . 50..	851 00 RM 12.. P s . 50..	1.668 (50.00)	1.668 (50.00)	0.750 (19.07)	0.451 (11.70)	0.051 (1.32)	0.766 (19.48)	0.811 (20.62)	1.044 (26.54)	0.496 (12.60)	0.123 (3.13)	0.137 (3.50)
14	851 00 M 14.. P s . 50..	851 00 RM 14.. P s . 50..	1.668 (50.00)	1.668 (50.00)	0.876 (22.25)	0.451 (11.70)	0.051 (1.32)	0.838 (21.30)	0.905 (23.00)	1.137 (28.89)	0.626 (15.90)	0.123 (3.13)	0.137 (3.50)
16	851 00 M 16.. P s . 50..	851 00 RM 16.. P s . 50..	1.668 (50.00)	1.668 (50.00)	1.000 (25.42)	0.451 (11.70)	0.051 (1.32)	0.964 (24.50)	0.968 (24.61)	1.231 (31.29)	0.746 (18.95)	0.123 (3.13)	0.137 (3.50)
18	851 00 M 18.. P s . 50..	851 00 RM 18.. P s . 50..	1.668 (50.00)	1.668 (50.00)	1.126 (28.60)	0.451 (11.70)	0.051 (1.32)	1.041 (26.45)	1.061 (26.97)	1.326 (33.69)	0.822 (20.90)	0.123 (3.13)	0.137 (3.50)
20	851 00 M 20.. P s . 50..	851 00 RM 20.. P s . 50..	2.098 (53.30)	2.098 (53.30)	1.250 (31.77)	0.565 (14.35)	0.084 (2.15)	1.209 (30.73)	1.156 (29.36)	1.452 (36.89)	0.933 (23.70)	0.123 (3.13)	0.137 (3.50)
22	851 00 M 22.. P s . 50..	851 00 RM 22.. P s . 50..	2.098 (53.30)	2.098 (53.30)	1.376 (34.95)	0.565 (14.35)	0.084 (2.15)	1.348 (34.24)	1.250 (31.75)	1.574 (39.99)	1.047 (26.60)	0.123 (3.13)	0.137 (3.50)
24	851 00 M 24.. P s . 50..	851 00 RM 24.. P s . 50..	2.098 (53.30)	2.098 (53.30)	1.500 (38.12)	0.598 (15.20)	0.084 (2.15)	1.435 (36.47)	1.374 (34.92)	1.698 (43.15)	1.153 (29.30)	0.150 (3.81)	0.137 (3.50)

Square flange receptacle with straight backshell for potting

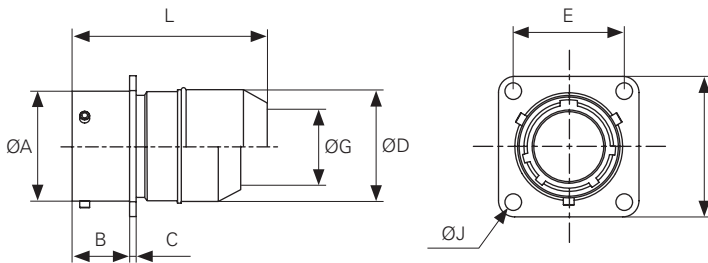

Cross reference

00 P	HE 301 B 00 P
	MS 3110 P
00 RP	HE 301 B 00 RP
	MS 3120 P

Shell size	Part numbers		L max		Ø A	B max	C max	Ø D max	E	F max	Ø G max	Ø J
	solder contacts	crimp contacts	solder	crimp								
8	851 00 P 8.. P s . 50..	851 00 RP 8.. P s . 50..	1.425 (36.20)	1.641 (41.70)	0.473 (12.03)	0.451 (11.70)	0.051 (1.32)	0.604 (15.34)	0.594 (15.09)	0.826 (20.99)	0.411 (10.46)	0.123 (3.13)
10	851 00 P 10.. P s . 50..	851 00 RP 10.. P s . 50..	1.425 (36.20)	1.641 (41.70)	0.590 (15.01)	0.451 (11.70)	0.051 (1.32)	0.696 (17.70)	0.718 (18.26)	0.952 (24.19)	0.533 (13.55)	0.123 (3.13)
12	851 00 P 12.. P s . 50..	851 00 RP 12.. P s . 50..	1.425 (36.20)	1.641 (41.70)	0.750 (19.07)	0.451 (11.70)	0.051 (1.32)	0.854 (21.69)	0.811 (20.62)	1.044 (26.54)	0.549 (13.96)	0.123 (3.13)
14	851 00 P 14.. P s . 50..	851 00 RP 14.. P s . 50..	1.425 (36.20)	1.641 (41.70)	0.876 (22.25)	0.451 (11.70)	0.051 (1.32)	0.940 (23.90)	0.905 (23.00)	1.137 (28.89)	0.685 (17.42)	0.123 (3.13)
16	851 00 P 16.. P s . 50..	851 00 RP 16.. P s . 50..	1.425 (36.20)	1.641 (41.70)	1.000 (25.42)	0.451 (11.70)	0.051 (1.32)	1.063 (27.00)	0.968 (24.61)	1.231 (31.29)	0.809 (20.56)	0.123 (3.13)
18	851 00 P 18.. P s . 50..	851 00 RP 18.. P s . 50..	1.453 (36.91)	1.750 (44.46)	1.126 (28.60)	0.451 (11.70)	0.051 (1.32)	1.200 (30.50)	1.061 (26.97)	1.326 (33.69)	0.931 (23.66)	0.123 (3.13)
20	851 00 P 20.. P s . 50..	851 00 RP 20.. P s . 50..	1.724 (43.80)	2.005 (50.93)	1.250 (31.77)	0.565 (14.35)	0.084 (2.15)	1.324 (33.65)	1.156 (29.36)	1.452 (36.89)	0.941 (23.92)	0.123 (3.13)
22	851 00 P 22.. P s . 50..	851 00 RP 22.. P s . 50..	1.724 (43.80)	2.005 (50.93)	1.376 (34.95)	0.565 (14.35)	0.084 (2.15)	1.460 (37.10)	1.250 (31.75)	1.574 (39.99)	1.004 (25.52)	0.123 (3.13)
24	851 00 P 24.. P s . 50..	851 00 RP 24.. P s . 50..	1.724 (43.80)	2.023 (51.40)	1.500 (38.12)	0.598 (15.20)	0.084 (2.15)	1.574 (40.00)	1.374 (34.92)	1.698 (43.15)	1.259 (32.00)	0.150 (3.81)

Dimensions are in inches (millimeters)

Square flange receptacle with straight backshell for heatshrink sleeving

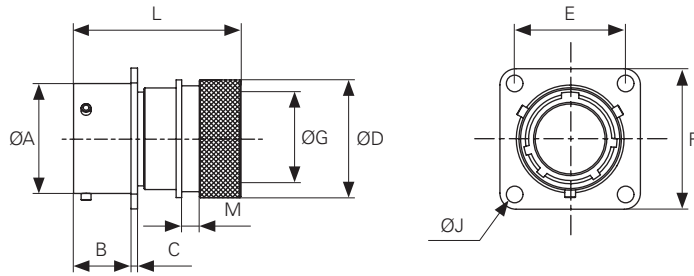

Shell size	Part numbers solder contacts	crimp contacts	L max solder	crimp	Ø A	B max	C max	Ø D max	E	F max	Ø G Max Solder	crimp	Ø J	M max
8	851 00 T 8.. P s . 50..	851 00 RT 8.. P s . 50..	1.444 (36.70)	1.417 (36.00)	0.473 (12.03)	0.460 (11.70)	0.051 (1.32)	0.604 (15.35)	0.594 (15.09)	0.826 (20.99)	0.283 (7.20)	0.263 (6.70)	0.123 (3.13)	0.145 (3.70)
10	851 00 T 10.. P s . 50..	851 00 RT 10.. P s . 50..	1.444 (36.70)	1.417 (36.00)	0.590 (15.01)	0.460 (11.70)	0.051 (1.32)	0.714 (18.15)	0.718 (18.26)	0.952 (24.19)	0.401 (10.20)	0.370 (9.40)	0.123 (3.13)	0.145 (3.70)
12	851 00 T 12.. P s . 50..	851 00 RT 12.. P s . 50..	1.444 (36.70)	1.417 (36.00)	0.750 (19.07)	0.460 (11.70)	0.051 (1.32)	0.923 (23.45)	0.811 (20.62)	1.044 (26.54)	0.519 (13.20)	0.460 (11.95)	0.123 (3.13)	0.145 (3.70)
14	851 00 T 14.. P s . 50..	851 00 RT 14.. P s . 50..	1.444 (36.70)	1.417 (36.00)	0.876 (22.25)	0.460 (11.70)	0.051 (1.32)	0.954 (24.25)	0.905 (23.00)	1.137 (28.89)	0.633 (16.10)	0.596 (15.15)	0.123 (3.13)	0.145 (3.70)
16	851 00 T 16.. P s . 50..	851 00 RT 16.. P s . 50..	1.535 (39.00)	1.507 (38.30)	1.000 (25.42)	0.460 (11.70)	0.051 (1.32)	1.163 (29.55)	1.061 (26.97)	1.231 (31.29)	0.757 (19.25)	0.710 (18.05)	0.123 (3.13)	0.145 (3.70)
18	851 00 T 18.. P s . 50..	851 00 RT 18.. P s . 50..	1.535 (39.00)	1.507 (38.30)	1.126 (28.60)	0.460 (11.70)	0.051 (1.32)	1.250 (31.75)	1.061 (26.97)	1.326 (33.69)	0.838 (21.30)	0.785 (19.95)	0.123 (3.13)	0.145 (3.70)
20	851 00 T 20.. P s . 50..	851 00 RT 20.. P s . 50..	1.783 (45.30)	1.740 (44.20)	1.250 (31.77)	0.565 (14.35)	0.084 (2.15)	1.411 (35.85)	1.411 (35.85)	1.452 (36.89)	0.960 (24.40)	0.907 (23.05)	0.123 (3.13)	0.145 (3.70)
22	851 00 T 22.. P s . 50..	851 00 RT 22.. P s . 50..	1.783 (45.30)	1.740 (44.20)	1.376 (34.95)	0.565 (14.35)	0.084 (2.15)	1.503 (38.20)	1.250 (31.75)	1.574 (39.99)	1.082 (27.50)	1.006 (25.55)	0.123 (3.13)	0.145 (3.70)
24	851 00 T 24.. P s . 50..	851 00 RT 24.. P s . 50..	1.732 (44.00)	1.677 (42.60)	1.500 (38.12)	0.598 (15.20)	0.084 (2.15)	1.626 (41.30)	1.374 (34.92)	1.698 (43.15)	1.204 (30.60)	1.127 (28.65)	0.150 (3.81)	0.145 (3.70)

Square flange receptacle with removable backshell for screen termination and heatshrink sleeving (38 & 42 suffix)

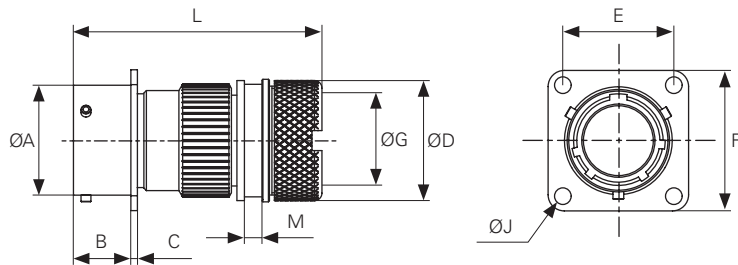

Shell size	Part numbers solder contacts	crimp contacts	L max solder	crimp	Ø A	B max	C max	Ø D max	E	F max	Ø G max	J	M max
8	851 00 T 8.. P s . 50..	851 00 RT 8.. P s . 50..	2.031 (51.60)	2.031 (51.60)	0.473 (12.03)	0.451 (11.70)	0.051 (1.32)	0.718 (18.25)	0.594 (15.09)	0.826 (20.99)	0.293 (7.45)	0.123 (3.13)	0.145 (3.70)
10	851 00 T 10.. P s . 50..	851 00 RT 10.. P s . 50..	2.031 (51.60)	2.031 (51.60)	0.590 (15.01)	0.451 (11.70)	0.051 (1.32)	0.797 (20.25)	0.718 (18.26)	0.952 (24.19)	0.354 (9.00)	0.123 (3.13)	0.145 (3.70)
12	851 00 T 12.. P s . 50..	851 00 RT 12.. P s . 50..	2.031 (51.60)	2.031 (51.60)	0.750 (19.07)	0.451 (11.70)	0.051 (1.32)	0.974 (24.75)	0.811 (20.62)	1.044 (26.54)	0.523 (13.30)	0.123 (3.13)	0.145 (3.70)
14	851 00 T 14.. P s . 50..	851 00 RT 14.. P s . 50..	2.031 (51.60)	2.031 (51.60)	0.876 (22.25)	0.451 (11.70)	0.051 (1.32)	1.092 (27.75)	0.905 (23.00)	1.137 (28.89)	0.649 (16.50)	0.123 (3.13)	0.145 (3.70)
16	851 00 T 16.. P s . 50..	851 00 RT 16.. P s . 50..	2.031 (51.60)	2.031 (51.60)	1.000 (25.42)	0.451 (11.70)	0.051 (1.32)	1.183 (30.05)	0.968 (24.61)	1.231 (31.29)	0.728 (18.50)	0.123 (3.13)	0.145 (3.70)
18	851 00 T 18.. P s . 50..	851 00 RT 18.. P s . 50..	2.047 (52.00)	2.047 (52.00)	1.126 (28.60)	0.451 (11.70)	0.051 (1.32)	1.344 (34.15)	1.061 (26.97)	1.326 (33.69)	0.862 (21.90)	0.123 (3.13)	0.145 (3.70)
20	851 00 T 20.. P s . 50..	851 00 RT 20.. P s . 50..	2.169 (55.10)	2.169 (55.10)	1.250 (31.77)	0.565 (14.35)	0.084 (2.15)	1.466 (37.25)	1.156 (29.36)	1.452 (36.89)	0.988 (25.10)	0.123 (3.13)	0.145 (3.70)
22	851 00 T 22.. P s . 50..	851 00 RT 22.. P s . 50..	2.169 (55.10)	2.169 (55.10)	1.376 (34.95)	0.565 (14.35)	0.084 (2.15)	1.592 (40.45)	1.250 (31.75)	1.574 (39.99)	1.110 (28.20)	0.123 (3.13)	0.145 (3.70)
24	851 00 T 24.. P s . 50..	851 00 RT 24.. P s . 50..	2.169 (55.10)	2.169 (55.10)	1.500 (38.12)	0.598 (15.20)	0.084 (2.15)	1.718 (43.65)	1.374 (34.92)	1.698 (43.15)	1.236 (31.40)	0.150 (3.81)	0.145 (3.70)

Dimensions are in inches (millimeters)

Souriau 851 series

Hermetic versions

Cable in-line receptacle with straight adaptor

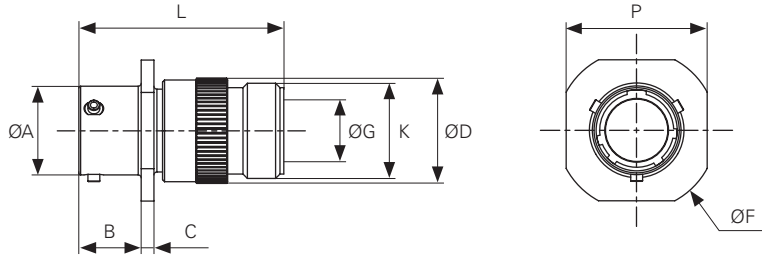

Cross reference

01 A	HE 301 B 01 A
01 RA	HE 301 B 01 RA

Shell size	Part numbers solder contacts	crimp contacts	L max solder	crimp	Ø A	B max	C max	Ø D max	Ø F max	Ø G max	K threading UNE F 2A	p max
8	851 01 A 8.. P s . 50..	851 01 RA 8.. P s . 50 ..	1.614 (41.00)	1.614 (41.00)	0.473 (12.03)	0.417 (10.60)	0.087 (2.22)	0.570 (14.50)	0.954 (24.24)	0.358 (9.10)	1/2 18	0.826 (20.99)
10	851 01 A 10.. P s . 50..	851 01 RA 10.. P s . 50..	1.614 (41.00)	1.614 (41.00)	0.590 (15.01)	0.417 (10.60)	0.087 (2.22)	0.736 (18.70)	1.080 (27.44)	0.475 (12.08)	5/8 24	0.952 (24.19)
12	851 01 A 12.. P s . 50..	851 01 RA 12.. P s . 50..	1.614 (41.00)	1.614 (41.00)	0.750 (19.07)	0.417 (10.60)	0.087 (2.22)	0.854 (21.70)	1.172 (29.79)	0.600 (15.25)	3/4 20	1.044 (26.54)
14	851 01 A 14.. P s . 50..	851 01 RA 14.. P s . 50..	1.614 (41.00)	1.614 (41.00)	0.876 (22.25)	0.417 (10.60)	0.087 (2.22)	0.988 (25.10)	1.263 (32.10)	0.714 (18.15)	7/8 20	1.137 (28.89)
16	851 01 A 16.. P s . 50..	851 01 RA 16.. P s . 50..	1.614 (41.00)	1.614 (41.00)	1.000 (25.42)	0.417 (10.60)	0.087 (2.22)	1.107 (28.13)	1.361 (34.59)	0.839 (21.32)	1-20	1.231 (31.29)
18	851 01 A 18.. P s . 50..	851 01 RA 18.. P s . 50..	1.614 (41.00)	1.614 (41.00)	1.126 (28.60)	0.417 (10.60)	0.087 (2.22)	1.235 (31.38)	1.454 (36.94)	0.957 (24.32)	1-3/16 18	1.326 (33.69)
20	851 01 A 20.. P s . 50..	851 01 RA 20.. P s . 50..	1.732 (44.00)	1.732 (44.00)	1.250 (31.77)	0.545 (13.85)	0.104 (2.65)	1.350 (34.30)	1.580 (40.15)	1.052 (26.73)	1-3/16 18	1.452 (36.89)
22	851 01 A 22.. P s . 50..	851 01 RA 22.. P s . 50..	1.732 (44.00)	1.732 (44.00)	1.376 (34.95)	0.545 (13.85)	0.104 (2.65)	1.480 (37.60)	1.663 (42.24)	1.207 (30.67)	1-7/16 18	1.574 (40.00)
24	851 01 A 24.. P s . 50..	851 01 RA 24.. P s . 50..	1.732 (44.00)	1.732 (44.00)	1.500 (38.12)	0.578 (14.70)	0.104 (2.65)	1.602 (40.70)	1.828 (46.44)	1.302 (33.08)	1-7/16 18	1.704 (43.29)

Cable in-line receptacle with straight cable clamp

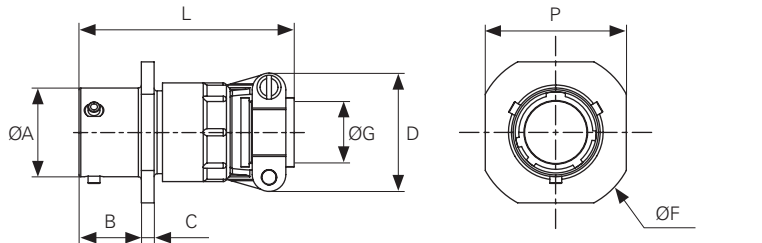

Cross reference

01 EC	HE 301 B 01 EC
	MS 3111 F
01 AC	HE 301 B 01 AC
01 RC	HE 301 B 01 RC
	MS 3121 F

Shell size	Part numbers solder contacts	crimp contacts	L max solder	crimp	Ø A	B max	C max	D max	Ø F max	Ø G max	P max
8	851 01 EC Ac 8.. P s . 50..	851 01 RC 8.. P s . 50..	1.889 (48.00)	1.862 (47.30)	0.473 (12.03)	0.417 (10.60)	0.087 (2.22)	0.783 (19.90)	0.954 (24.24)	0.137 (3.50)	0.826 (20.99)
10	851 01 EC Ac 10.. P s . 50..	851 01 RC 10.. P s . 50..	1.889 (48.00)	1.862 (47.30)	0.590 (15.01)	0.417 (10.60)	0.087 (2.22)	0.846 (21.50)	1.080 (27.44)	0.196 (5.00)	0.952 (24.19)
12	851 01 EC Ac 12.. P s . 50..	851 01 RC 12.. P s . 50..	1.889 (48.00)	1.862 (47.30)	0.750 (19.07)	0.417 (10.60)	0.087 (2.22)	0.984 (25.00)	1.172 (29.79)	0.322 (8.20)	1.044 (26.54)
14	851 01 EC Ac 14.. P s . 50..	851 01 RC 14.. P s . 50..	1.889 (48.00)	1.862 (47.30)	0.876 (22.25)	0.417 (10.60)	0.087 (2.22)	1.094 (27.80)	1.263 (32.10)	0.393 (10.00)	1.137 (28.89)
16	851 01 EC Ac 16.. P s . 50..	851 01 RC 16.. P s . 50..	2.007 (51.00)	1.988 (50.50)	1.000 (25.42)	0.417 (10.60)	0.087 (2.22)	1.157 (29.40)	1.361 (34.59)	0.511 (13.00)	1.231 (31.29)
18	851 01 EC Ac 18.. P s . 50..	851 01 RC 18.. P s . 50..	2.007 (51.00)	1.988 (50.50)	1.126 (28.60)	0.417 (10.60)	0.087 (2.22)	1.389 (35.30)	1.454 (36.94)	0.629 (16.00)	1.326 (33.69)
20	851 01 EC Ac 20.. P s . 50..	851 01 RC 20.. P s . 50..	2.086 (53.00)	2.027 (51.50)	1.250 (31.77)	0.545 (13.85)	0.104 (2.65)	1.389 (35.30)	1.580 (40.15)	0.629 (16.00)	1.452 (36.89)
22	851 01 EC Ac 22.. P s . 50..	851 01 RC 22.. P s . 50..	2.086 (53.00)	2.027 (51.50)	1.376 (34.95)	0.545 (13.85)	0.104 (2.65)	1.618 (41.10)	1.663 (42.24)	0.759 (19.30)	1.574 (40.00)
24	851 01 EC Ac 24.. P s . 50..	851 01 RC 24.. P s . 50..	2.086 (53.00)	2.027 (51.50)	1.500 (38.12)	0.578 (14.70)	0.104 (2.65)	1.669 (42.40)	1.828 (46.44)	0.811 (20.60)	1.704 (43.29)

Dimensions are in inches (millimeters)

Cable in-line receptacle with backnut

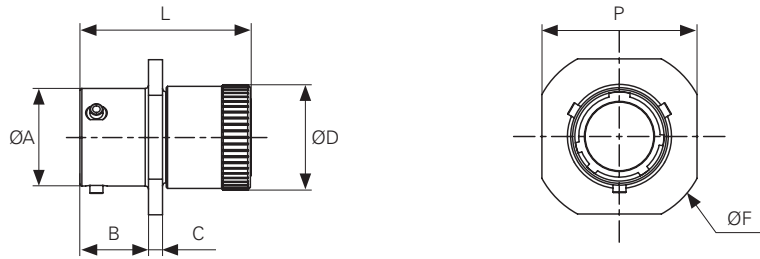

Cross reference

01 E	HE 301 B 01 E
	MS 3111 E
01 R	HE 301 B 01 R
	MS 3121 E

Shell size	Part numbers solder contacts	Part numbers crimp contacts	L max solder	L max crimp	Ø A	B max	C max	Ø D max	Ø F max	P max
8	851 01 E 8.. ^P s . 50..	851 01 R 8.. ^P s . 50..	1.287 (32.70)	1.259 (32.00)	0.473 (12.03)	0.417 (10.60)	0.087 (2.22)	0.531 (13.50)	0.954 (24.24)	0.826 (20.99)
10	851 01 E 10.. ^P s . 50..	851 01 R 10.. ^P s . 50..	1.287 (32.70)	1.259 (32.00)	0.590 (15.01)	0.417 (10.60)	0.087 (2.22)	0.657 (16.70)	1.080 (27.44)	0.952 (24.19)
12	851 01 E 12.. ^P s . 50..	851 01 R 12.. ^P s . 50..	1.287 (32.70)	1.259 (32.00)	0.750 (19.07)	0.417 (10.60)	0.087 (2.22)	0.783 (19.90)	1.172 (29.79)	1.044 (26.54)
14	851 01 E 14.. ^P s . 50..	851 01 R 14.. ^P s . 50..	1.287 (32.70)	1.259 (32.00)	0.876 (22.25)	0.417 (10.60)	0.087 (2.22)	0.921 (23.40)	1.263 (32.10)	1.137 (28.89)
16	851 01 E 16.. ^P s . 50..	851 01 R 16.. ^P s . 50..	1.287 (32.70)	1.259 (32.00)	1.000 (25.42)	0.417 (10.60)	0.087 (2.22)	1.047 (26.60)	1.361 (34.59)	1.231 (31.29)
18	851 01 E 18.. ^P s . 50..	851 01 R 18.. ^P s . 50..	1.287 (32.70)	1.259 (32.00)	1.126 (28.60)	0.417 (10.60)	0.087 (2.22)	1.161 (29.50)	1.454 (36.94)	1.326 (33.69)
20	851 01 E 20.. ^P s . 50..	851 01 R 20.. ^P s . 50..	1.358 (34.50)	1.315 (33.40)	1.250 (31.77)	0.545 (13.85)	0.104 (2.65)	1.287 (32.70)	1.580 (40.15)	1.452 (36.89)
22	851 01 E 22.. ^P s . 50..	851 01 R 22.. ^P s . 50..	1.358 (34.50)	1.315 (33.40)	1.376 (34.95)	0.545 (13.85)	0.104 (2.65)	1.417 (36.00)	1.663 (42.24)	1.574 (40.00)
24	851 01 E 24.. ^P s . 50..	851 01 R 24.. ^P s . 50..	1.358 (34.50)	1.315 (33.40)	1.500 (38.12)	0.578 (14.70)	0.104 (2.65)	1.539 (39.10)	1.828 (46.44)	1.704 (43.29)

Cable in line receptacle with removable straight backshell for screen termination and heatshrink sleeving

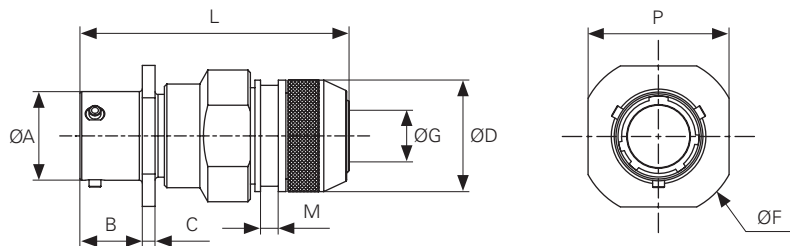

Shell size	Part numbers solder contacts	Part numbers crimp contacts	L max solder	L max crimp	Ø A	B max	C max	Ø D max	Ø F max	Ø G max	M max	P max
8	851 01 G 8.. ^P s . 50..	851 01 RG 8.. ^P s . 50..	2.126 (54.00)	2.126 (54.00)	0.473 (12.03)	0.417 (10.60)	0.087 (2.22)	0.641 (16.30)	0.954 (24.24)	0.293 (7.45)	0.141 (3.60)	0.826 (20.99)
10	851 01 G 10.. ^P s . 50..	851 01 RG 10.. ^P s . 50..	2.126 (54.00)	2.126 (54.00)	0.590 (15.01)	0.417 (10.60)	0.087 (2.22)	0.720 (18.30)	1.080 (27.44)	0.405 (10.30)	0.141 (3.60)	0.952 (24.19)
12	851 01 G 12.. ^P s . 50..	851 01 RG 12.. ^P s . 50..	2.126 (54.00)	2.126 (54.00)	0.750 (19.07)	0.417 (10.60)	0.087 (2.22)	0.878 (22.30)	1.172 (29.79)	0.519 (13.20)	0.141 (3.60)	1.044 (26.54)
14	851 01 G 14.. ^P s . 50..	851 01 RG 14.. ^P s . 50..	2.126 (54.00)	2.126 (54.00)	0.876 (22.25)	0.417 (10.60)	0.087 (2.22)	0.996 (25.30)	1.263 (32.10)	0.649 (16.50)	0.141 (3.60)	1.137 (28.89)
16	851 01 G 16.. ^P s . 50..	851 01 RG 16.. ^P s . 50..	2.126 (54.00)	2.126 (54.00)	1.000 (25.42)	0.417 (10.60)	0.087 (2.22)	1.114 (28.30)	1.361 (34.59)	0.761 (19.35)	0.141 (3.60)	1.231 (31.29)
18	851 01 G 18.. ^P s . 50..	851 01 RG 18.. ^P s . 50..	2.126 (54.00)	2.126 (54.00)	1.126 (28.60)	0.417 (10.60)	0.087 (2.22)	1.271 (32.30)	1.454 (36.94)	0.850 (21.60)	0.141 (3.60)	1.326 (33.69)
20	851 01 G 20.. ^P s . 50..	851 01 RG 20.. ^P s . 50..	2.334 (59.30)	2.334 (59.30)	1.250 (31.77)	0.545 (13.85)	0.104 (2.65)	1.350 (34.30)	1.580 (40.15)	0.976 (24.80)	0.141 (3.60)	1.452 (36.89)
22	851 01 G 22.. ^P s . 50..	851 01 RG 22.. ^P s . 50..	2.334 (59.30)	2.334 (59.30)	1.376 (34.95)	0.545 (13.85)	0.104 (2.65)	1.507 (38.30)	1.663 (42.24)	1.098 (27.90)	0.141 (3.60)	1.574 (40.00)
24	851 01 G 24.. ^P s . 50..	851 01 RG 24.. ^P s . 50..	2.334 (59.30)	2.334 (59.30)	1.500 (38.12)	0.578 (14.70)	0.104 (2.65)	1.626 (41.30)	1.828 (46.44)	1.220 (31.00)	0.141 (3.60)	1.704 (43.29)

Dimensions are in inches (millimeters)

Souriau 851 series

Hermetic versions

Cable in-line receptacle with straight sealing gland backshell

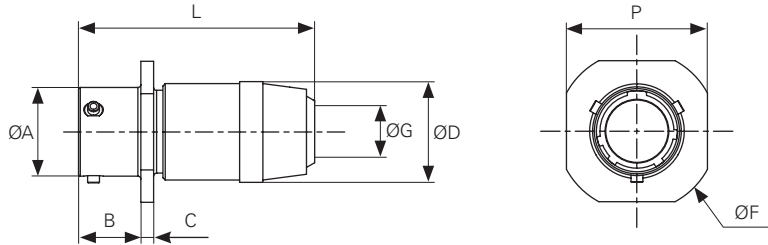

Cross reference

01 J	HE 301 B 01 J
------	---------------

Shell size	Part numbers solder contacts	crimp contacts	L max solder	crimp	Ø A	B max	C max	Ø D max	Ø F max	Ø G min	max	P max
8	851 01 J 8.. ^P s. s. 50..	—	1.874 (47.60)	—	0.473 (12.03)	0.417 (10.60)	0.087 (2.22)	0.567 (14.40)	0.954 (24.24)	0.197 (5.02)	0.230 (5.84)	0.826 (20.99)
10	851 01 J 10.. ^P s. s. 50..	—	1.874 (47.60)	—	0.590 (15.01)	0.417 (10.60)	0.087 (2.22)	0.693 (17.60)	1.080 (27.44)	0.233 (5.94)	0.266 (6.76)	0.952 (24.19)
12	851 01 J 12.. ^P s. s. 50..	—	1.917 (48.70)	—	0.750 (19.07)	0.417 (10.60)	0.087 (2.22)	0.830 (21.10)	1.172 (29.79)	0.367 (9.34)	0.400 (10.16)	1.044 (26.54)
14	851 01 J 14.. ^P s. s. 50..	—	2.106 (53.50)	—	0.876 (22.25)	0.417 (10.60)	0.087 (2.22)	0.960 (24.40)	1.263 (32.10)	0.445 (11.32)	0.478 (12.14)	1.137 (28.89)
16	851 01 J 16.. ^P s. s. 50..	—	2.322 (59.00)	—	1.000 (25.42)	0.417 (10.60)	0.087 (2.22)	1.086 (27.60)	1.361 (34.59)	0.578 (14.73)	0.612 (15.55)	1.231 (31.29)
18	851 01 J 18.. ^P s. s. 50..	—	2.559 (65.00)	—	1.126 (28.60)	0.417 (10.60)	0.087 (2.22)	1.212 (30.80)	1.454 (36.94)	0.629 (16.00)	0.662 (16.82)	1.326 (33.69)
20	851 01 J 20.. ^P s. s. 50..	—	3.114 (79.10)	—	1.250 (31.77)	0.545 (13.85)	0.104 (2.65)	1.342 (34.10)	1.580 (40.15)	0.665 (16.89)	0.697 (17.71)	1.452 (36.89)
22	851 01 J 22.. ^P s. s. 50..	—	3.149 (80.00)	—	1.376 (34.95)	0.545 (13.85)	0.104 (2.65)	1.468 (37.30)	1.663 (42.24)	0.700 (17.78)	0.732 (18.60)	1.574 (40.00)
24	851 01 J 24.. ^P s. s. 50..	—	3.543 (90.00)	—	1.500 (38.12)	0.578 (14.70)	0.104 (2.65)	1.594 (40.50)	1.828 (46.44)	0.800 (20.34)	0.833 (21.16)	1.704 (43.29)

Cable in-line receptacle with straight sealing gland and cable clamp backshell

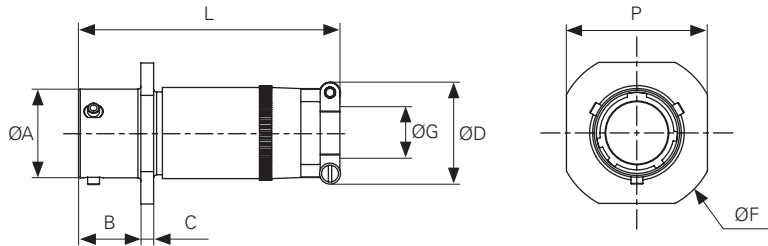

Cross reference

01 JC	HE 301 B 01 J
-------	---------------

Shell size	Part numbers solder contacts	crimp contacts	L max solder	crimp	Ø A	B max	C max	Ø D max	E	Ø F max	Ø G min	max	P max
8	851 01 JC 8.. ^P s. s. 50..	—	2.270 (57.68)	—	0.473 (12.03)	0.417 (10.60)	0.087 (2.22)	0.783 (19.90)	0.594 (15.09)	0.954 (24.24)	0.197 (5.02)	0.230 (5.84)	0.826 (20.99)
10	851 01 JC 10.. ^P s. s. 50..	—	2.270 (57.68)	—	0.590 (15.01)	0.417 (10.60)	0.087 (2.22)	0.846 (21.50)	0.718 (18.26)	1.080 (27.44)	0.233 (5.94)	0.266 (6.76)	0.952 (24.19)
12	851 01 JC 12.. ^P s. s. 50..	—	2.411 (61.24)	—	0.750 (19.07)	0.417 (10.60)	0.087 (2.22)	0.984 (25.00)	0.811 (20.62)	1.172 (29.79)	0.367 (9.34)	0.400 (10.16)	1.044 (26.54)
14	851 01 JC 14.. ^P s. s. 50..	—	2.598 (66.01)	—	0.876 (22.25)	0.417 (10.60)	0.087 (2.22)	1.094 (27.80)	0.905 (23.00)	1.263 (32.10)	0.445 (11.32)	0.478 (12.14)	1.137 (28.89)
16	851 01 JC 16.. ^P s. s. 50..	—	2.943 (74.75)	—	1.000 (25.42)	0.417 (10.60)	0.087 (2.22)	1.157 (29.40)	0.968 (24.61)	1.361 (34.59)	0.578 (14.73)	0.612 (15.55)	1.231 (31.29)
18	851 01 JC 18.. ^P s. s. 50..	—	3.172 (80.57)	—	1.126 (28.60)	0.417 (10.60)	0.087 (2.22)	1.389 (35.30)	1.061 (26.97)	1.454 (36.94)	0.629 (16.00)	0.662 (16.82)	1.326 (33.69)
20	851 01 JC 20.. ^P s. s. 50..	—	3.609 (91.69)	—	1.250 (31.77)	0.545 (13.85)	0.104 (2.65)	1.389 (35.30)	1.156 (29.36)	1.580 (40.15)	0.665 (16.89)	0.696 (17.70)	1.452 (36.89)
22	851 01 JC 22.. ^P s. s. 50..	—	3.766 (95.66)	—	1.376 (34.95)	0.545 (13.85)	0.104 (2.65)	1.618 (41.10)	1.250 (31.75)	1.663 (42.24)	0.700 (17.78)	0.732 (18.60)	1.574 (40.00)
24	851 01 JC 24.. ^P s. s. 50..	—	3.985 (101.22)	—	1.500 (38.12)	0.578 (14.70)	0.104 (2.65)	1.669 (42.40)	1.374 (34.92)	1.828 (46.44)	0.800 (20.34)	0.833 (21.16)	1.704 (43.29)

Dimensions are in inches (millimeters)

Cable connecting receptacle with removable straight backshell for heatshrink sleeving

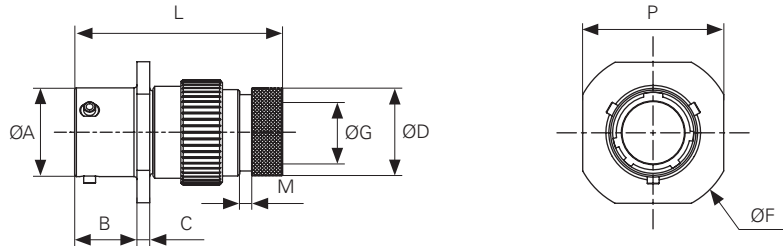

Shell size	Part numbers		L max		Ø A	B max	C max	Ø D max	Ø F max	Ø G max	M max	P max
	solder contacts	crimp contacts	solder	crimp								
8	851 01 M 8.. P s . 50..	851 01 RM 8.. P s . 50..	1.668 (50.00)	1.668 (50.00)	0.473 (12.03)	0.417 (10.60)	0.087 (2.22)	0.533 (13.55)	0.954 (24.24)	0.277 (7.05)	0.137 (3.50)	0.826 (20.99)
10	851 01 M 10.. P s . 50..	851 01 RM 10.. P s . 50..	1.668 (50.00)	1.668 (50.00)	0.590 (15.01)	0.417 (10.60)	0.087 (2.22)	0.604 (15.35)	1.080 (27.44)	0.389 (9.90)	0.137 (3.50)	0.952 (24.19)
12	851 01 M 12.. P s . 50..	851 01 RM 12.. P s . 50..	1.668 (50.00)	1.668 (50.00)	0.750 (19.07)	0.417 (10.60)	0.087 (2.22)	0.766 (19.48)	1.172 (29.79)	0.496 (12.60)	0.137 (3.50)	1.044 (26.54)
14	851 01 M 14.. P s . 50..	851 01 RM 14.. P s . 50..	1.668 (50.00)	1.668 (50.00)	0.876 (22.25)	0.417 (10.60)	0.087 (2.22)	0.838 (21.30)	1.263 (32.10)	0.626 (15.90)	0.137 (3.50)	1.137 (28.89)
16	851 01 M 16.. P s . 50..	851 01 RM 16.. P s . 50..	1.668 (50.00)	1.668 (50.00)	1.000 (25.42)	0.417 (10.60)	0.087 (2.22)	0.964 (24.50)	1.361 (34.59)	0.746 (18.95)	0.137 (3.50)	1.231 (31.29)
18	851 01 M 18.. P s . 50..	851 01 RM 18.. P s . 50..	1.668 (50.00)	1.668 (50.00)	1.126 (28.60)	0.417 (10.60)	0.087 (2.22)	1.041 (26.45)	1.454 (36.94)	0.822 (20.90)	0.137 (3.50)	1.326 (33.69)
20	851 01 M 20.. P s . 50..	851 01 RM 20.. P s . 50..	2.098 (53.30)	2.098 (53.30)	1.250 (31.77)	0.545 (13.85)	0.104 (2.65)	1.209 (30.73)	1.580 (40.15)	0.933 (23.70)	0.137 (3.50)	1.452 (36.89)
22	851 01 M 22.. P s . 50..	851 01 RM 22.. P s . 50..	2.098 (53.30)	2.098 (53.30)	1.376 (34.95)	0.545 (13.85)	0.104 (2.65)	1.348 (34.24)	1.663 (42.24)	1.047 (26.60)	0.137 (3.50)	1.574 (40.00)
24	851 01 M 24.. P s . 50..	851 01 RM 24.. P s . 50..	2.098 (53.30)	2.098 (53.30)	1.500 (38.12)	0.578 (14.70)	0.104 (2.65)	1.435 (36.47)	1.828 (46.44)	1.153 (29.30)	0.137 (3.50)	1.704 (43.29)

Cable connecting receptacle with straight backshell for potting

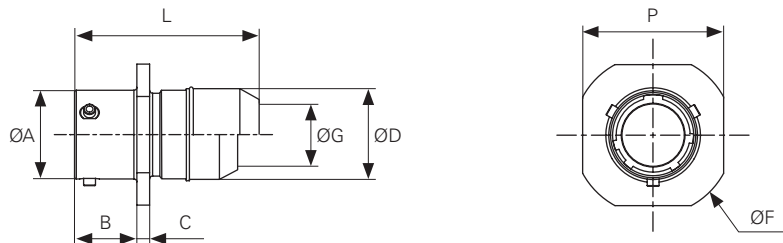

Cross reference

01 P	HE 301 B 01 P
	MS 3111 P
01 RP	HE 301 B 01 RP
	MS 3121 P

Shell size	Part numbers		L max		Ø A	B max	C max	Ø D max	Ø F max	Ø G max	P max
	solder contacts	crimp contacts	solder	crimp							
8	851 01 P 8.. P s . 50..	851 01 RP 8.. P s . 50..	1.425 (36.20)	1.641 (41.70)	0.473 (12.03)	0.417 (10.60)	0.087 (2.22)	0.604 (15.34)	0.954 (24.24)	0.411 (10.46)	0.826 (20.99)
10	851 01 P 10.. P s . 50..	851 01 RP 10.. P s . 50..	1.425 (36.20)	1.641 (41.70)	0.590 (15.01)	0.417 (10.60)	0.087 (2.22)	0.696 (17.70)	1.080 (27.44)	0.533 (13.55)	0.952 (24.19)
12	851 01 P 12.. P s . 50..	851 01 RP 12.. P s . 50..	1.425 (36.20)	1.641 (41.70)	0.750 (19.07)	0.417 (10.60)	0.087 (2.22)	0.854 (21.69)	1.172 (29.79)	0.549 (13.96)	1.044 (26.54)
14	851 01 P 14.. P s . 50..	851 01 RP 14.. P s . 50..	1.425 (36.20)	1.641 (41.70)	0.876 (22.25)	0.417 (10.60)	0.087 (2.22)	0.940 (23.90)	1.263 (32.10)	0.685 (17.42)	1.137 (28.89)
16	851 01 P 16.. P s . 50..	851 01 RP 16.. P s . 50..	1.425 (36.20)	1.641 (41.70)	1.000 (25.42)	0.417 (10.60)	0.087 (2.22)	1.063 (27.00)	1.361 (34.59)	0.809 (20.56)	1.231 (31.29)
18	851 01 P 18.. P s . 50..	851 01 RP 18.. P s . 50..	1.453 (36.91)	1.750 (44.46)	1.126 (28.60)	0.417 (10.60)	0.087 (2.22)	1.200 (30.50)	1.454 (36.94)	0.931 (23.66)	1.326 (33.69)
20	851 01 P 20.. P s . 50..	851 01 RP 20.. P s . 50..	1.724 (43.80)	2.005 (50.93)	1.250 (31.77)	0.545 (13.85)	0.104 (2.65)	1.324 (33.65)	1.580 (40.15)	0.941 (23.92)	1.452 (36.89)
22	851 01 P 22.. P s . 50..	851 01 RP 22.. P s . 50..	1.724 (43.80)	2.005 (50.93)	1.376 (34.95)	0.545 (13.85)	0.104 (2.65)	1.460 (37.10)	1.663 (42.24)	1.004 (25.52)	1.574 (40.00)
24	851 01 P 24.. P s . 50..	851 01 RP 24.. P s . 50..	1.724 (43.80)	2.023 (51.40)	1.500 (38.12)	0.578 (14.70)	0.104 (2.65)	1.574 (40.00)	1.828 (46.44)	1.259 (32.00)	1.704 (43.29)

Dimensions are in inches (millimeters)

Souriau 851 series

Hermetic versions

Cable in-line receptacle with straight backshell for heatshrink sleeving

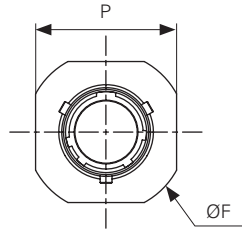
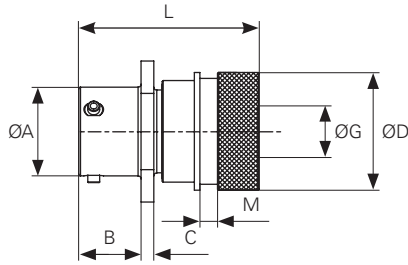

Shell size	Part numbers		L max		Ø A	B max	C max	Ø D max	F max	Ø G max		M max	P max
	solder contacts	crimp contacts	solder	crimp						solder	crimp		
8	851 01 T 8.. ^P s . 50..	851 01 RT 8.. ^P s . 50..	1.444 (36.70)	1.417 (36.00)	0.473 (12.03)	0.417 (10.60)	0.087 (2.22)	0.604 (15.35)	0.954 (24.24)	0.283 (7.20)	0.263 (6.70)	0.145 (3.70)	0.826 (20.99)
10	851 01 T 10.. ^P s . 50..	851 01 RT 10.. ^P s . 50..	1.444 (36.70)	1.417 (36.00)	0.590 (15.01)	0.417 (10.60)	0.087 (2.22)	0.714 (18.15)	1.080 (27.44)	0.401 (10.20)	0.370 (9.40)	0.145 (3.70)	0.952 (24.19)
12	851 01 T 12.. ^P s . 50..	851 01 RT 12.. ^P s . 50..	1.444 (36.70)	1.417 (36.00)	0.750 (19.07)	0.417 (10.60)	0.087 (2.22)	0.923 (23.45)	1.172 (29.79)	0.519 (13.20)	0.460 (11.95)	0.145 (3.70)	1.044 (26.54)
14	851 01 T 14.. ^P s . 50..	851 01 RT 14.. ^P s . 50..	1.444 (36.70)	1.417 (36.00)	0.876 (22.25)	0.417 (10.60)	0.087 (2.22)	0.954 (24.25)	1.263 (32.10)	0.633 (16.10)	0.596 (15.15)	0.145 (3.70)	1.137 (28.89)
16	851 01 T 16.. ^P s . 50..	851 01 RT 16.. ^P s . 50..	1.535 (39.00)	1.507 (38.30)	1.000 (25.42)	0.417 (10.60)	0.087 (2.22)	1.163 (29.55)	1.361 (34.59)	0.757 (19.25)	0.710 (18.05)	0.145 (3.70)	1.231 (31.29)
18	851 01 T 18.. ^P s . 50..	851 01 RT 18.. ^P s . 50..	1.535 (39.00)	1.507 (38.30)	1.126 (28.60)	0.417 (10.60)	0.087 (2.22)	1.250 (31.75)	1.454 (36.94)	0.838 (21.30)	0.785 (19.95)	0.145 (3.70)	1.326 (33.69)
20	851 01 T 20.. ^P s . 50..	851 01 RT 20.. ^P s . 50..	1.783 (45.30)	1.740 (44.20)	1.250 (31.77)	0.545 (13.85)	0.104 (2.65)	1.411 (35.85)	1.580 (40.15)	0.960 (24.40)	0.907 (23.05)	0.145 (3.70)	1.452 (36.89)
22	851 01 T 22.. ^P s . 50..	851 01 RT 22.. ^P s . 50..	1.783 (45.30)	1.740 (44.20)	1.376 (34.95)	0.545 (13.85)	0.104 (2.65)	1.503 (38.20)	1.663 (42.24)	1.082 (27.50)	1.006 (25.55)	0.145 (3.70)	1.574 (40.00)
24	851 01 T 24.. ^P s . 50..	851 01 RT 24.. ^P s . 50..	1.732 (44.00)	1.677 (42.60)	1.500 (38.12)	0.578 (14.70)	0.104 (2.65)	1.626 (41.30)	1.828 (46.44)	1.204 (30.60)	1.127 (28.65)	0.145 (3.70)	1.704 (43.29)

Cable connecting receptacle with removable straight backshell for screen termination and heatshrink sleeving (38 & 42 suffix)

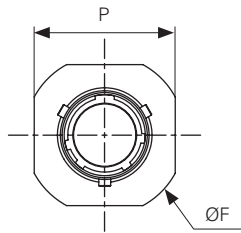
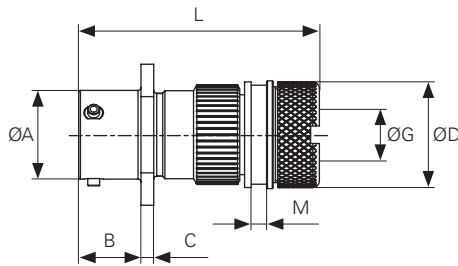

Shell size	Part numbers		L max		Ø A	B max	C max	Ø D max	E	F max	Ø G max	M max	P max
	solder contacts	crimp contacts	solder	crimp									
8	851 01 T 8.. ^P s . 50 ³⁸ ₄₂	851 01 RT 8.. ^P s . 50 ³⁸ ₄₂	2.031 (51.60)	2.031 (51.60)	0.473 (12.03)	0.417 (10.60)	0.087 (2.22)	0.718 (18.25)	0.594 (15.09)	0.954 (24.24)	0.293 (7.45)	0.145 (3.70)	0.826 (20.99)
10	851 01 T 10.. ^P s . 50 ³⁸ ₄₂	851 01 RT 10.. ^P s . 50 ³⁸ ₄₂	2.031 (51.60)	2.031 (51.60)	0.590 (15.01)	0.417 (10.60)	0.087 (2.22)	0.797 (20.25)	0.718 (18.26)	1.080 (27.44)	0.354 (9.00)	0.145 (3.70)	0.952 (24.19)
12	851 01 T 12.. ^P s . 50 ³⁸ ₄₂	851 01 RT 12.. ^P s . 50 ³⁸ ₄₂	2.031 (51.60)	2.031 (51.60)	0.750 (19.07)	0.417 (10.60)	0.087 (2.22)	0.974 (24.75)	0.811 (20.62)	1.172 (29.79)	0.523 (13.30)	0.145 (3.70)	1.044 (26.54)
14	851 01 T 14.. ^P s . 50 ³⁸ ₄₂	851 01 RT 14.. ^P s . 50 ³⁸ ₄₂	2.031 (51.60)	2.031 (51.60)	0.876 (22.25)	0.417 (10.60)	0.087 (2.22)	1.092 (27.75)	0.905 (23.00)	1.263 (32.10)	0.649 (16.50)	0.145 (3.70)	1.137 (28.89)
16	851 01 T 16.. ^P s . 50 ³⁸ ₄₂	851 01 RT 16.. ^P s . 50 ³⁸ ₄₂	2.031 (51.60)	2.031 (51.60)	1.000 (25.42)	0.417 (10.60)	0.087 (2.22)	1.183 (30.05)	0.968 (24.61)	1.361 (34.59)	0.728 (18.50)	0.145 (3.70)	1.231 (31.29)
18	851 01 T 18.. ^P s . 50 ³⁸ ₄₂	851 01 RT 18.. ^P s . 50 ³⁸ ₄₂	2.047 (52.00)	2.047 (52.00)	1.126 (28.60)	0.417 (10.60)	0.087 (2.22)	1.344 (34.15)	1.061 (26.97)	1.454 (36.94)	0.862 (21.90)	0.145 (3.70)	1.326 (33.69)
20	851 01 T 20.. ^P s . 50 ³⁸ ₄₂	851 01 RT 20.. ^P s . 50 ³⁸ ₄₂	2.169 (55.10)	2.169 (55.10)	1.250 (31.77)	0.545 (13.85)	0.104 (2.65)	1.466 (37.25)	1.156 (29.36)	1.580 (40.15)	0.988 (25.10)	0.145 (3.70)	1.452 (36.89)
22	851 01 T 22.. ^P s . 50 ³⁸ ₄₂	851 01 RT 22.. ^P s . 50 ³⁸ ₄₂	2.169 (55.10)	2.169 (55.10)	1.376 (34.95)	0.545 (13.85)	0.104 (2.65)	1.592 (40.45)	1.250 (31.75)	1.663 (42.24)	1.110 (28.20)	0.145 (3.70)	1.574 (40.00)
24	851 01 T 24.. ^P s . 50 ³⁸ ₄₂	851 01 RT 24.. ^P s . 50 ³⁸ ₄₂	2.169 (55.10)	2.169 (55.10)	1.500 (38.12)	0.578 (14.70)	0.104 (2.65)	1.718 (43.65)	1.374 (34.92)	1.828 (46.44)	1.236 (31.40)	0.145 (3.70)	1.704 (43.29)

Dimensions are in inches (millimeters)

Square flange receptacle not accepting backshell

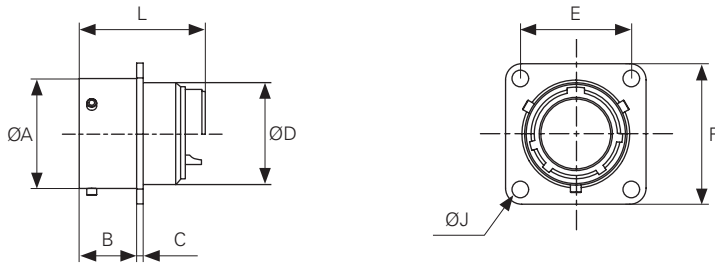

Cross reference

02 E	HE 301 B 02 E
	MS 3112 E
	VG 95328 H
02 R	HE 301 B 02 R
	MS 3122 E
	VG 95328 C

Shell size	Part numbers solder contacts	crimp contacts	L max solder	crimp	Ø A	B max	C max	Ø D max	E	F max	J
8	851 02 E 8.. ^P s . 50..	851 02 R 8.. ^P s . 50..	0.991 (25.18)	1.273 (32.35)	0.473 (12.03)	0.451 (11.70)	0.051 (1.32)	0.426 (10.84)	0.594 (15.09)	0.826 (20.99)	0.123 (3.13)
10	851 02 E 10.. ^P s . 50..	851 02 R 10.. ^P s . 50..	0.988 (25.10)	1.273 (32.35)	0.590 (15.01)	0.451 (11.70)	0.051 (1.32)	0.550 (13.99)	0.718 (18.26)	0.952 (24.19)	0.123 (3.13)
12	851 02 E 12.. ^P s . 50..	851 02 R 12.. ^P s . 50..	0.988 (25.10)	1.273 (32.35)	0.750 (19.07)	0.451 (11.70)	0.051 (1.32)	0.683 (17.37)	0.811 (20.62)	1.044 (26.54)	0.123 (3.13)
14	851 02 E 14.. ^P s . 50..	851 02 R 14.. ^P s . 50..	0.988 (25.10)	1.273 (32.35)	0.876 (22.25)	0.451 (11.70)	0.051 (1.32)	0.809 (20.57)	0.905 (23.00)	1.137 (28.89)	0.123 (3.13)
16	851 02 E 16.. ^P s . 50..	851 02 R 16.. ^P s . 50..	0.988 (25.10)	1.273 (32.35)	1.000 (25.42)	0.451 (11.70)	0.051 (1.32)	0.933 (23.72)	0.968 (24.61)	1.231 (31.29)	0.123 (3.13)
18	851 02 E 18.. ^P s . 50..	851 02 R 18.. ^P s . 50..	0.988 (25.10)	1.273 (32.35)	1.126 (28.60)	0.451 (11.70)	0.051 (1.32)	1.050 (26.69)	1.061 (26.97)	1.326 (33.69)	0.123 (3.13)
20	851 02 E 20.. ^P s . 50..	851 02 R 20.. ^P s . 50..	1.050 (26.67)	1.336 (33.95)	1.250 (31.77)	0.565 (14.35)	0.084 (2.15)	1.176 (29.89)	1.156 (29.36)	1.452 (36.89)	0.123 (3.13)
22	851 02 E 22.. ^P s . 50..	851 02 R 22.. ^P s . 50..	1.050 (26.67)	1.336 (33.95)	1.376 (34.95)	0.565 (14.35)	0.084 (2.15)	1.300 (33.04)	1.250 (31.75)	1.574 (39.99)	0.123 (3.13)
24	851 02 E 24.. ^P s . 50..	851 02 R 24.. ^P s . 50..	1.050 (26.67)	1.336 (33.95)	1.500 (38.12)	0.598 (15.20)	0.084 (2.15)	1.426 (36.24)	1.374 (34.92)	1.698 (43.15)	0.150 (3.81)

Jam nut receptacle not accepting backshell

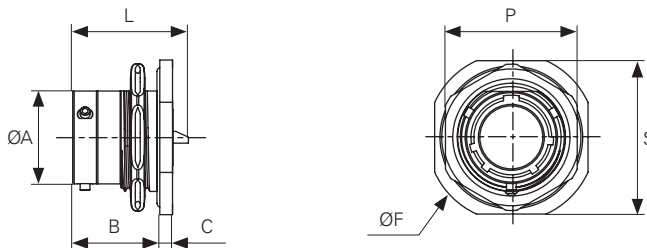

Cross reference

07 A	HE 301 B 07 A
-------------	---------------

Shell size	Part numbers solder contacts	crimp contacts	L max solder	crimp	Ø A	B max	C max	Ø F max	P max	S max
8	851 07 A 8.. ^P s . 50..	—	0.991 (25.18)	—	0.473 (12.03)	0.704 (17.90)	0.104 (2.64)	1.060 (26.94)	0.759 (19.29)	0.942 (23.94)
10	851 07 A 10.. ^P s . 50..	—	0.988 (25.10)	—	0.590 (15.01)	0.704 (17.90)	0.104 (2.64)	1.186 (30.14)	0.881 (22.38)	1.060 (26.94)
12	851 07 A 12.. ^P s . 50..	—	0.988 (25.10)	—	0.750 (19.07)	0.704 (17.90)	0.104 (2.64)	1.375 (34.94)	1.068 (27.13)	1.249 (31.74)
14	851 07 A 14.. ^P s . 50..	—	0.988 (25.10)	—	0.876 (22.25)	0.704 (17.90)	0.104 (2.64)	1.497 (38.04)	1.194 (30.33)	1.375 (34.94)
16	851 07 A 16.. ^P s . 50..	—	0.988 (25.10)	—	1.000 (25.42)	0.704 (17.90)	0.104 (2.64)	1.623 (41.24)	1.318 (33.48)	1.505 (38.24)
18	851 07 A 18.. ^P s . 50..	—	0.988 (25.10)	—	1.126 (28.60)	0.704 (17.90)	0.104 (2.64)	1.749 (44.44)	1.444 (36.68)	1.627 (41.34)
20	851 07 A 20.. ^P s . 50..	—	1.050 (26.67)	—	1.250 (31.77)	0.883 (22.45)	0.135 (3.44)	1.934 (49.14)	1.568 (39.83)	1.812 (46.04)
22	851 07 A 22.. ^P s . 50..	—	1.050 (26.67)	—	1.376 (34.95)	0.883 (22.45)	0.135 (3.44)	2.056 (52.24)	1.694 (43.03)	1.938 (49.24)
24	851 07 A 24.. ^P s . 50..	—	1.050 (26.67)	—	1.500 (38.12)	0.917 (23.30)	0.135 (3.44)	2.186 (55.54)	1.818 (46.18)	2.076 (52.74)

Dimensions are in inches (millimeters)

Souriau 851 series

Hermetic versions

Jam nut receptacle with backnut

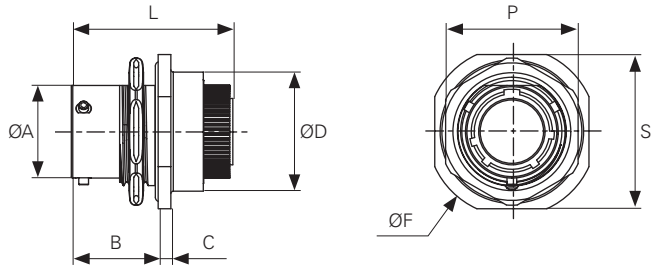

Cross reference

07 E	HE 301 B 07 E
	MS 3114 E
07 R	HE 301 B 07 R
	MS 3124 E
	VG 95328 D

Shell size	Part numbers solder contacts	Part numbers crimp contacts	L max solder	L max crimp	Ø A	B max	C max	Ø F max	P max	S max
8	851 07 E 8.. ^P _S . 50..	851 07 R 8.. ^P _S . 50..	1.342 (34.10)	1.318 (33.50)	0.473 (12.03)	0.704 (17.90)	0.104 (2.64)	1.060 (26.94)	0.759 (19.29)	0.942 (23.94)
10	851 07 E 10.. ^P _S . 50..	851 07 R 10.. ^P _S . 50..	1.342 (34.10)	1.318 (33.50)	0.590 (15.01)	0.704 (17.90)	0.104 (2.64)	1.186 (30.14)	0.881 (22.38)	1.060 (26.94)
12	851 07 E 12.. ^P _S . 50..	851 07 R 12.. ^P _S . 50..	1.342 (34.10)	1.318 (33.50)	0.750 (19.07)	0.704 (17.90)	0.104 (2.64)	1.375 (34.94)	1.068 (27.13)	1.249 (31.74)
14	851 07 E 14.. ^P _S . 50..	851 07 R 14.. ^P _S . 50..	1.342 (34.10)	1.318 (33.50)	0.876 (22.25)	0.704 (17.90)	0.104 (2.64)	1.497 (38.04)	1.194 (30.33)	1.375 (34.94)
16	851 07 E 16.. ^P _S . 50..	851 07 R 16.. ^P _S . 50..	1.342 (34.10)	1.318 (33.50)	1.000 (25.42)	0.704 (17.90)	0.104 (2.64)	1.623 (41.24)	1.318 (33.48)	1.505 (38.24)
18	851 07 E 18.. ^P _S . 50..	851 07 R 18.. ^P _S . 50..	1.342 (34.10)	1.318 (33.50)	1.126 (28.60)	0.704 (17.90)	0.104 (2.64)	1.749 (44.44)	1.444 (36.68)	1.627 (41.34)
20	851 07 E 20.. ^P _S . 50..	851 07 R 20.. ^P _S . 50..	1.547 (39.30)	1.492 (37.90)	1.250 (31.77)	0.883 (22.45)	0.135 (3.44)	1.934 (49.14)	1.568 (39.83)	1.812 (46.04)
22	851 07 E 22.. ^P _S . 50..	851 07 R 22.. ^P _S . 50..	1.547 (39.30)	1.492 (37.90)	1.376 (34.95)	0.883 (22.45)	0.135 (3.44)	2.056 (52.24)	1.694 (43.03)	1.938 (49.24)
24	851 07 E 24.. ^P _S . 50..	851 07 R 24.. ^P _S . 50..	1.547 (39.30)	1.492 (37.90)	1.500 (38.12)	0.917 (23.30)	0.135 (3.44)	2.186 (55.54)	1.818 (46.18)	2.076 (52.74)

Jam nut receptacle with straight cable clamp

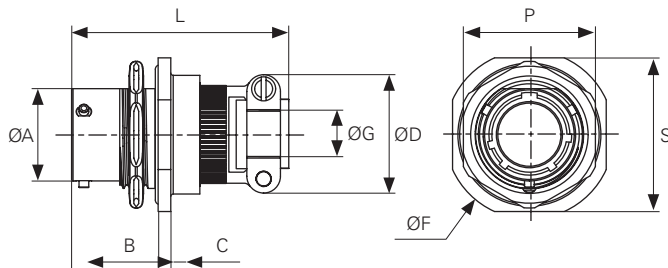

Cross reference

07 EC	HE 301 B 07 EC
	MS 3114 F
07 AC	HE 301 B 07 AC
07 RC	HE 301 B 07 RC
	MS 3124 F
	VG 95328 E

Shell size	Part numbers solder contacts	Part numbers crimp contacts	L max solder	L max crimp	Ø A	B max	C max	D max	Ø F max	Ø G max	P max	S max
8	851 07 ^{EC} _{AC} 8.. ^P _S . 50..	851 07 RC 8.. ^P _S . 50..	1.941 (49.31)	1.933 (49.10)	0.473 (12.03)	0.704 (17.90)	0.104 (2.64)	0.783 (19.90)	1.060 (26.94)	0.137 (3.50)	0.759 (19.29)	0.942 (23.94)
10	851 07 ^{EC} _{AC} 10.. ^P _S . 50..	851 07 RC 10.. ^P _S . 50..	1.941 (49.31)	1.933 (49.10)	0.590 (15.01)	0.704 (17.90)	0.104 (2.64)	0.846 (21.50)	1.186 (30.14)	0.196 (5.00)	0.881 (22.38)	1.060 (26.94)
12	851 07 ^{EC} _{AC} 12.. ^P _S . 50..	851 07 RC 12.. ^P _S . 50..	1.935 (49.17)	1.933 (49.10)	0.750 (19.07)	0.704 (17.90)	0.104 (2.64)	0.984 (25.00)	1.375 (34.94)	0.322 (8.20)	1.068 (27.13)	1.249 (31.74)
14	851 07 ^{EC} _{AC} 14.. ^P _S . 50..	851 07 RC 14.. ^P _S . 50..	1.935 (49.17)	1.933 (49.10)	0.876 (22.25)	0.704 (17.90)	0.104 (2.64)	1.094 (27.80)	1.497 (38.04)	0.393 (10.00)	1.194 (30.33)	1.375 (34.94)
16	851 07 ^{EC} _{AC} 16.. ^P _S . 50..	851 07 RC 16.. ^P _S . 50..	2.060 (52.34)	2.055 (52.20)	1.000 (25.42)	0.704 (17.90)	0.104 (2.64)	1.157 (29.40)	1.623 (41.24)	0.511 (13.00)	1.318 (33.48)	1.505 (38.24)
18	851 07 ^{EC} _{AC} 18.. ^P _S . 50..	851 07 RC 18.. ^P _S . 50..	2.095 (53.22)	2.090 (53.10)	1.126 (28.60)	0.704 (17.90)	0.104 (2.64)	1.389 (35.30)	1.749 (44.44)	0.629 (16.00)	1.444 (36.68)	1.627 (41.34)
20	851 07 ^{EC} _{AC} 20.. ^P _S . 50..	851 07 RC 20.. ^P _S . 50..	2.287 (58.10)	2.283 (58.00)	1.250 (31.77)	0.883 (22.45)	0.135 (3.44)	1.389 (35.30)	1.934 (49.14)	0.629 (16.00)	1.568 (39.83)	1.812 (46.04)
22	851 07 ^{EC} _{AC} 22.. ^P _S . 50..	851 07 RC 22.. ^P _S . 50..	2.287 (58.10)	2.283 (58.00)	1.376 (34.95)	0.883 (22.45)	0.135 (3.44)	1.618 (41.10)	2.056 (52.24)	0.759 (19.30)	1.694 (43.03)	1.938 (49.24)
24	851 07 ^{EC} _{AC} 24.. ^P _S . 50..	851 07 RC 24.. ^P _S . 50..	2.287 (58.10)	2.283 (58.00)	1.500 (38.12)	0.917 (23.30)	0.135 (3.44)	1.669 (42.40)	2.186 (55.54)	0.811 (20.60)	1.818 (46.18)	2.076 (52.74)

Dimensions are in inches (millimeters)

Jam nut receptacle with removable straight backshell for screen termination and heatshrink sleeving

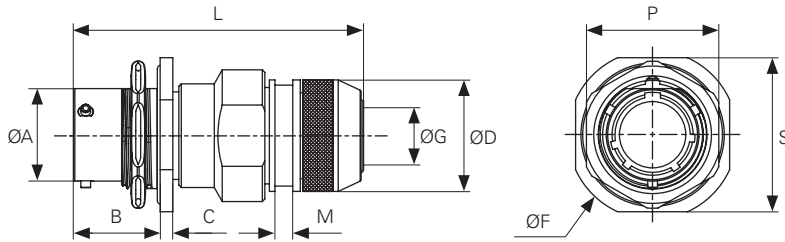

Cross reference

07 G	–
07 RG	VG 95328 T

Shell size	Part numbers		L max	Ø A	B max	C max	Ø D max	Ø F max	Ø G max	M max	P max	S max
	solder contacts	crimp contacts										
8	851 07 G 8.. ^P s. 50..	851 07 RG 8.. ^P s. 50..	2.448 (62.20)	0.473 (12.03)	0.704 (17.90)	0.104 (2.64)	0.641 (16.30)	1.060 (26.94)	0.293 (7.45)	0.141 (3.60)	0.759 (19.29)	0.942 (23.94)
10	851 07 G 10.. ^P s. 50..	851 07 RG 10.. ^P s. 50..	2.448 (62.20)	0.590 (15.01)	0.704 (17.90)	0.104 (2.64)	0.720 (18.30)	1.186 (30.14)	0.405 (10.30)	0.141 (3.60)	0.881 (22.38)	1.060 (26.94)
12	851 07 G 12.. ^P s. 50..	851 07 RG 12.. ^P s. 50..	2.448 (62.20)	0.750 (19.07)	0.704 (17.90)	0.104 (2.64)	0.878 (22.30)	1.375 (34.94)	0.519 (13.20)	0.141 (3.60)	1.068 (27.13)	1.249 (31.74)
14	851 07 G 14.. ^P s. 50..	851 07 RG 14.. ^P s. 50..	2.456 (62.40)	0.876 (22.25)	0.704 (17.90)	0.104 (2.64)	0.996 (25.30)	1.497 (38.04)	0.649 (16.50)	0.141 (3.60)	1.194 (30.33)	1.375 (34.94)
16	851 07 G 16.. ^P s. 50..	851 07 RG 16.. ^P s. 50..	2.456 (62.40)	1.000 (25.42)	0.704 (17.90)	0.104 (2.64)	1.114 (28.30)	1.623 (41.24)	0.761 (19.35)	0.141 (3.60)	1.318 (33.48)	1.505 (38.24)
18	851 07 G 18.. ^P s. 50..	851 07 RG 18.. ^P s. 50..	2.456 (62.40)	1.126 (28.60)	0.704 (17.90)	0.104 (2.64)	1.271 (32.30)	1.749 (44.44)	0.850 (21.60)	0.141 (3.60)	1.444 (36.68)	1.627 (41.34)
20	851 07 G 20.. ^P s. 50..	851 07 RG 20.. ^P s. 50..	2.657 (67.50)	1.250 (31.77)	0.883 (22.45)	0.135 (3.44)	1.350 (34.30)	1.934 (49.14)	0.976 (24.80)	0.141 (3.60)	1.568 (39.83)	1.812 (46.04)
22	851 07 G 22.. ^P s. 50..	851 07 RG 22.. ^P s. 50..	2.657 (67.50)	1.376 (34.95)	0.883 (22.45)	0.135 (3.44)	1.507 (38.30)	2.056 (52.24)	1.098 (27.90)	0.141 (3.60)	1.694 (43.03)	1.938 (49.24)
24	851 07 G 24.. ^P s. 50..	851 07 RG 24.. ^P s. 50..	2.657 (67.50)	1.500 (38.12)	0.917 (23.30)	0.135 (3.44)	1.626 (41.30)	2.186 (55.54)	1.220 (31.00)	0.141 (3.60)	1.818 (46.18)	2.076 (52.74)

Jam nut receptacle with straight backshell for potting

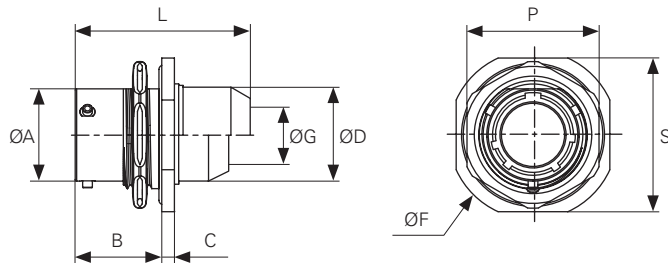

Cross reference

07 P	HE 301 B 07 P
	MS 3114 P
07 RP	HE 301 B 07 RP
	MS 3124 P

Shell size	Part numbers		L max	Ø A	B max	C max	Ø D max	Ø F max	Ø G max	P max	S max
	solder contacts	crimp contacts									
8	851 07 P 8.. ^P s. 50..	851 07 RP 8.. ^P s. 50..	1.350 (34.30)	0.473 (12.03)	0.704 (17.90)	0.104 (2.64)	0.954 (24.24)	1.060 (26.94)	0.411 (10.46)	0.759 (19.29)	0.942 (23.94)
10	851 07 P 10.. ^P s. 50..	851 07 RP 10.. ^P s. 50..	1.350 (34.30)	0.590 (15.01)	0.704 (17.90)	0.104 (2.64)	1.080 (27.44)	1.186 (30.14)	0.533 (13.55)	0.881 (22.38)	1.060 (26.94)
12	851 07 P 12.. ^P s. 50..	851 07 RP 12.. ^P s. 50..	1.350 (34.30)	0.750 (19.07)	0.704 (17.90)	0.104 (2.64)	1.172 (29.79)	1.375 (34.94)	0.549 (13.96)	1.068 (27.13)	1.249 (31.74)
14	851 07 P 14.. ^P s. 50..	851 07 RP 14.. ^P s. 50..	1.350 (34.30)	0.876 (22.25)	0.704 (17.90)	0.104 (2.64)	1.263 (32.10)	1.497 (38.04)	0.685 (17.42)	1.194 (30.33)	1.375 (34.94)
16	851 07 P 16.. ^P s. 50..	851 07 RP 16.. ^P s. 50..	1.350 (34.30)	1.000 (25.42)	0.704 (17.90)	0.104 (2.64)	1.361 (34.59)	1.623 (41.24)	0.809 (20.56)	1.318 (33.48)	1.505 (38.24)
18	851 07 P 18.. ^P s. 50..	851 07 RP 18.. ^P s. 50..	1.342 (34.10)	1.126 (28.60)	0.704 (17.90)	0.104 (2.64)	1.454 (36.94)	1.749 (44.44)	0.931 (23.66)	1.444 (36.68)	1.627 (41.34)
20	851 07 P 20.. ^P s. 50..	851 07 RP 20.. ^P s. 50..	1.663 (42.25)	1.250 (31.77)	0.883 (22.45)	0.135 (3.44)	1.580 (40.15)	1.934 (49.14)	0.941 (23.92)	1.568 (39.83)	1.812 (46.04)
22	851 07 P 22.. ^P s. 50..	851 07 RP 22.. ^P s. 50..	1.663 (42.25)	1.376 (34.95)	0.883 (22.45)	0.135 (3.44)	1.663 (42.24)	2.056 (52.24)	1.004 (25.52)	1.694 (43.03)	1.938 (49.24)
24	851 07 P 24.. ^P s. 50..	851 07 RP 24.. ^P s. 50..	1.703 (43.26)	1.500 (38.12)	0.917 (23.30)	0.135 (3.44)	1.828 (46.44)	2.186 (55.54)	1.259 (32.00)	1.818 (46.18)	2.076 (52.74)

Dimensions are in inches (millimeters)

Souriau 851 series

Hermetic versions

Jam nut receptacle with straight backshell for heatshrink sleeving

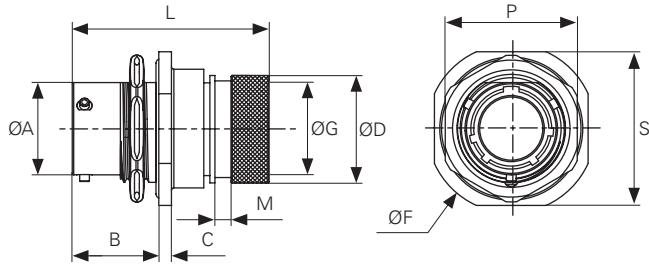

Cross reference

07 T	–
07 RT	VG 95328 S

Shell size	Part numbers		L max		Ø A	B max	C max	Ø D max	Ø F max	Ø G max		M max	P max	S max
	solder contacts	crimp contacts	solder	crimp						solder	crimp			
8	851 07 T 8.. ^P _{S . 50..}	851 07 RT 8.. ^P _{S . 50..}	1.677 (42.60)	1.633 (41.50)	0.473 (12.03)	0.704 (17.90)	0.104 (2.64)	0.604 (15.35)	1.060 (26.94)	0.283 (7.20)	0.263 (6.70)	0.145 (3.70)	0.759 (19.29)	0.942 (23.94)
10	851 07 T 10.. ^P _{S . 50..}	851 07 RT 10.. ^P _{S . 50..}	1.677 (42.60)	1.633 (41.50)	0.590 (15.01)	0.704 (17.90)	0.104 (2.64)	0.714 (18.15)	1.186 (30.14)	0.401 (10.20)	0.370 (9.40)	0.145 (3.70)	0.881 (22.38)	1.060 (26.94)
12	851 07 T 12.. ^P _{S . 50..}	851 07 RT 12.. ^P _{S . 50..}	1.677 (42.60)	1.633 (41.50)	0.750 (19.07)	0.704 (17.90)	0.104 (2.64)	0.923 (23.45)	1.375 (34.94)	0.519 (13.20)	0.460 (11.95)	0.145 (3.70)	1.068 (27.13)	1.249 (31.74)
14	851 07 T 14.. ^P _{S . 50..}	851 07 RT 14.. ^P _{S . 50..}	1.677 (42.60)	1.633 (41.50)	0.876 (22.25)	0.704 (17.90)	0.104 (2.64)	0.954 (24.25)	1.497 (38.04)	0.633 (16.10)	0.596 (15.15)	0.145 (3.70)	1.194 (30.33)	1.375 (34.94)
16	851 07 T 16.. ^P _{S . 50..}	851 07 RT 16.. ^P _{S . 50..}	1.748 (44.40)	1.724 (43.80)	1.000 (25.42)	0.704 (17.90)	0.104 (2.64)	1.163 (29.55)	1.623 (41.24)	0.757 (19.25)	0.710 (18.05)	0.145 (3.70)	1.318 (33.48)	1.505 (38.24)
18	851 07 T 18.. ^P _{S . 50..}	851 07 RT 18.. ^P _{S . 50..}	1.748 (44.40)	1.724 (43.80)	1.126 (28.60)	0.704 (17.90)	0.104 (2.64)	1.250 (31.75)	1.749 (44.44)	0.838 (21.30)	0.785 (19.95)	0.145 (3.70)	1.444 (36.68)	1.627 (41.34)
20	851 07 T 20.. ^P _{S . 50..}	851 07 RT 20.. ^P _{S . 50..}	2.004 (50.90)	1.960 (49.80)	1.250 (31.77)	0.883 (22.45)	0.135 (3.44)	1.411 (35.85)	1.934 (49.14)	0.960 (24.40)	0.907 (23.05)	0.145 (3.70)	1.568 (39.83)	1.812 (46.04)
22	851 07 T 22.. ^P _{S . 50..}	851 07 RT 22.. ^P _{S . 50..}	2.004 (50.90)	1.960 (49.80)	1.376 (34.95)	0.883 (22.45)	0.135 (3.44)	1.503 (38.20)	2.056 (52.24)	1.082 (27.50)	1.006 (25.55)	0.145 (3.70)	1.694 (43.03)	1.938 (49.24)
24	851 07 T 24.. ^P _{S . 50..}	851 07 RT 24.. ^P _{S . 50..}	1.964 (49.90)	1.909 (48.50)	1.500 (38.12)	0.917 (23.30)	0.135 (3.44)	1.626 (41.30)	2.186 (55.54)	1.204 (30.60)	1.127 (28.65)	0.145 (3.70)	1.818 (46.18)	2.076 (52.74)

Jam nut receptacle with removable straight backshell for screen termination and heatshrink sleeving (38 & 42 suffix)

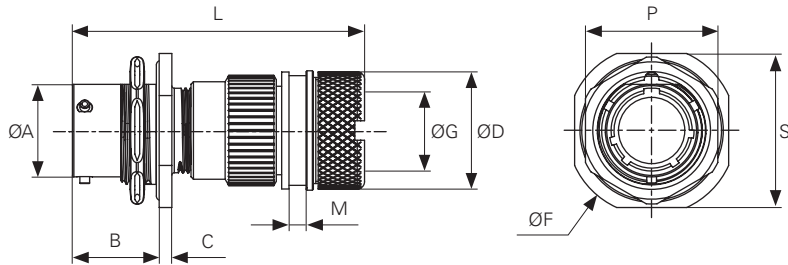

Shell size	Part numbers		L max		Ø A	B max	C max	Ø D max	Ø F max	Ø G max	M max	P max	S max
	solder contacts	crimp contacts	solder	crimp									
8	851 07 T 8.. ^P _{S . 50³⁸₄₂}	851 07 RT 8.. ^P _{S . 50³⁸₄₂}	2.362 (60.00)	2.362 (60.00)	0.473 (12.03)	0.704 (17.90)	0.104 (2.64)	0.718 (18.25)	1.060 (26.94)	0.293 (7.45)	0.145 (3.70)	0.759 (19.29)	0.942 (23.94)
10	851 07 T 10.. ^P _{S . 50³⁸₄₂}	851 07 RT 10.. ^P _{S . 50³⁸₄₂}	2.362 (60.00)	2.362 (60.00)	0.590 (15.01)	0.704 (17.90)	0.104 (2.64)	0.797 (20.25)	1.186 (30.14)	0.354 (9.00)	0.145 (3.70)	0.881 (22.38)	1.060 (26.94)
12	851 07 T 12.. ^P _{S . 50³⁸₄₂}	851 07 RT 12.. ^P _{S . 50³⁸₄₂}	2.362 (60.00)	2.362 (60.00)	0.750 (19.07)	0.704 (17.90)	0.104 (2.64)	0.974 (24.75)	1.375 (34.94)	0.523 (13.30)	0.145 (3.70)	1.068 (27.13)	1.249 (31.74)
14	851 07 T 14.. ^P _{S . 50³⁸₄₂}	851 07 RT 14.. ^P _{S . 50³⁸₄₂}	2.362 (60.00)	2.362 (60.00)	0.876 (22.25)	0.704 (17.90)	0.104 (2.64)	1.092 (27.75)	1.497 (38.04)	0.649 (16.50)	0.145 (3.70)	1.194 (30.33)	1.375 (34.94)
16	851 07 T 16.. ^P _{S . 50³⁸₄₂}	851 07 RT 16.. ^P _{S . 50³⁸₄₂}	2.362 (60.00)	2.362 (60.00)	1.000 (25.42)	0.704 (17.90)	0.104 (2.64)	1.183 (30.05)	1.623 (41.24)	0.728 (18.50)	0.145 (3.70)	1.318 (33.48)	1.505 (38.24)
18	851 07 T 18.. ^P _{S . 50³⁸₄₂}	851 07 RT 18.. ^P _{S . 50³⁸₄₂}	2.377 (60.40)	2.377 (60.40)	1.126 (28.60)	0.704 (17.90)	0.104 (2.64)	1.344 (34.15)	1.749 (44.44)	0.862 (21.90)	0.145 (3.70)	1.444 (36.68)	1.627 (41.34)
20	851 07 T 20.. ^P _{S . 50³⁸₄₂}	851 07 RT 20.. ^P _{S . 50³⁸₄₂}	2.496 (63.40)	2.496 (63.40)	1.250 (31.77)	0.883 (22.45)	0.135 (3.44)	1.466 (37.25)	1.934 (49.14)	0.988 (25.10)	0.145 (3.70)	1.568 (39.83)	1.812 (46.04)
22	851 07 T 22.. ^P _{S . 50³⁸₄₂}	851 07 RT 22.. ^P _{S . 50³⁸₄₂}	2.496 (63.40)	2.496 (63.40)	1.376 (34.95)	0.883 (22.45)	0.135 (3.44)	1.592 (40.45)	2.056 (52.24)	1.110 (28.20)	0.145 (3.70)	1.694 (43.03)	1.938 (49.24)
24	851 07 T 24.. ^P _{S . 50³⁸₄₂}	851 07 RT 24.. ^P _{S . 50³⁸₄₂}	2.496 (63.40)	2.496 (63.40)	1.500 (38.12)	0.917 (23.30)	0.135 (3.44)	1.718 (43.65)	2.186 (55.54)	1.236 (31.40)	0.145 (3.70)	1.818 (46.18)	2.076 (52.74)

Dimensions are in inches (millimeters)

Plug with straight adaptor

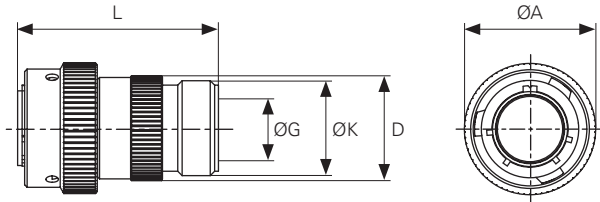

Cross reference

06 A	HE 301 B 06 A
06 RA	HE 301 B 06 RA

Shell size	Part numbers		L max		Ø A	Ø D max	Ø G max	F threading UNEF 2A
	solder contacts	crimp contacts	solder	crimp				
8	851 06 A 8.. P s . 50..	851 06 RA 8.. P s . 50..	1.614 (41.00)	1.614 (41.00)	0.750 (19.05)	0.570 (14.50)	0.358 (9.10)	1/2 18
10	851 06 A 10.. P s . 50..	851 06 RA 10.. P s . 50..	1.614 (41.00)	1.614 (41.00)	0.858 (21.80)	0.736 (18.70)	0.475 (12.08)	5/8 24
12	851 06 A 12.. P s . 50..	851 06 RA 12.. P s . 50..	1.614 (41.00)	1.614 (41.00)	1.029 (26.15)	0.854 (21.70)	0.600 (15.25)	3/4 20
14	851 06 A 14.. P s . 50..	851 06 RA 14.. P s . 50..	1.614 (41.00)	1.614 (41.00)	1.155 (29.35)	0.988 (25.10)	0.714 (18.15)	7/8 20
16	851 06 A 16.. P s . 50..	851 06 RA 16.. P s . 50..	1.614 (41.00)	1.614 (41.00)	1.279 (32.50)	1.107 (28.13)	0.839 (21.32)	1-20
18	851 06 A 18.. P s . 50..	851 06 RA 18.. P s . 50..	1.614 (41.00)	1.614 (41.00)	1.389 (35.30)	1.235 (31.38)	0.957 (24.32)	1-3/16 18
20	851 06 A 20.. P s . 50..	851 06 RA 20.. P s . 50..	1.732 (44.00)	1.704 (43.30)	1.529 (38.85)	1.350 (34.30)	1.052 (26.73)	1-3/16 18
22	851 06 A 22.. P s . 50..	851 06 RA 22.. P s . 50..	1.732 (44.00)	1.704 (43.30)	1.655 (42.05)	1.480 (37.60)	1.207 (30.67)	1-7/16 18
24	851 06 A 24.. P s . 50..	851 06 RA 24.. P s . 50..	1.732 (44.00)	1.712 (43.50)	1.775 (45.10)	1.602 (40.70)	1.302 (33.08)	1-7/16 18

Plug with straight cable clamp

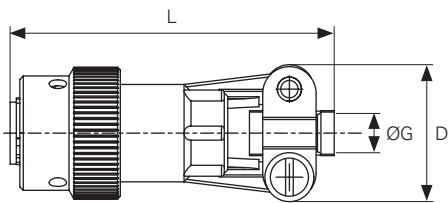

Cross reference

06 EC	HE 301 B 06 EC
	MS 3116 F
06 AC	HE 301 B 06 AC
06 RC	HE 301 B 06 RC
	MS 3126 F
	VG 95328 K

Shell size	Part numbers		L max		Ø A	D max	Ø G max
	solder contacts	crimp contacts	solder	crimp			
8	851 06 EC AC 8.. P s . 50..	851 06 RC 8.. P s . 50..	1.889 (48.00)	1.862 (47.30)	0.750 (19.05)	0.783 (19.90)	0.137 (3.50)
10	851 06 EC AC 10.. P s . 50..	851 06 RC 10.. P s . 50..	1.889 (48.00)	1.862 (47.30)	0.858 (21.80)	0.846 (21.50)	0.196 (5.00)
12	851 06 EC AC 12.. P s . 50..	851 06 RC 12.. P s . 50..	1.889 (48.00)	1.862 (47.30)	1.029 (26.15)	0.984 (25.00)	0.322 (8.20)
14	851 06 EC AC 14.. P s . 50..	851 06 RC 14.. P s . 50..	1.889 (48.00)	1.862 (47.30)	1.155 (29.35)	1.094 (27.80)	0.393 (10.00)
16	851 06 EC AC 16.. P s . 50..	851 06 RC 16.. P s . 50..	2.007 (51.00)	1.988 (50.50)	1.279 (32.50)	1.157 (29.40)	0.511 (13.00)
18	851 06 EC AC 18.. P s . 50..	851 06 RC 18.. P s . 50..	2.007 (51.00)	1.988 (50.50)	1.389 (35.30)	1.389 (35.30)	0.629 (16.00)
20	851 06 EC AC 20.. P s . 50..	851 06 RC 20.. P s . 50..	2.047 (52.00)	1.976 (50.20)	1.529 (38.85)	1.389 (35.30)	0.629 (16.00)
22	851 06 EC AC 22.. P s . 50..	851 06 RC 22.. P s . 50..	2.047 (52.00)	1.976 (50.20)	1.655 (42.05)	1.618 (41.10)	0.759 (19.30)
24	851 06 EC AC 24.. P s . 50..	851 06 RC 24.. P s . 50..	2.047 (52.00)	1.976 (50.20)	1.775 (45.10)	1.669 (42.40)	0.811 (20.60)

Dimensions are in inches (millimeters)

Souriau 851 series

Hermetic versions

Plug with backnut

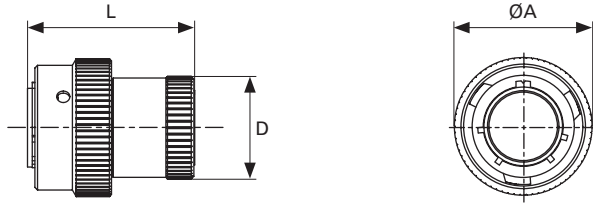

Cross reference

06 E	HE 301 B 06 E
	MS 3116 E
06 R	HE 301 B 06 R
	MS 3126 E

Shell size	Part numbers		L max		Ø A	Ø D max
	solder contacts	crimp contacts	solder	crimp		
8	851 06 E 8.. P s . 50..	851 06 R 8.. P s . 50..	1.281 (32.54)	1.259 (32.00)	0.750 (19.05)	0.531 (13.50)
10	851 06 E 10.. P s . 50..	851 06 R 10.. P s . 50..	1.281 (32.54)	1.259 (32.00)	0.858 (21.80)	0.657 (16.70)
12	851 06 E 12.. P s . 50..	851 06 R 12.. P s . 50..	1.281 (32.54)	1.259 (32.00)	1.029 (26.15)	0.783 (19.90)
14	851 06 E 14.. P s . 50..	851 06 R 14.. P s . 50..	1.281 (32.54)	1.259 (32.00)	1.155 (29.35)	0.921 (23.40)
16	851 06 E 16.. P s . 50..	851 06 R 16.. P s . 50..	1.281 (32.54)	1.259 (32.00)	1.279 (32.50)	1.047 (26.60)
18	851 06 E 18.. P s . 50..	851 06 R 18.. P s . 50..	1.281 (32.54)	1.259 (32.00)	1.389 (35.30)	1.165 (29.60)
20	851 06 E 20.. P s . 50..	851 06 R 20.. P s . 50..	1.311 (33.30)	1.263 (32.10)	1.529 (38.85)	1.287 (32.70)
22	851 06 E 22.. P s . 50..	851 06 R 22.. P s . 50..	1.311 (33.30)	1.263 (32.10)	1.655 (42.05)	1.417 (36.00)
24	851 06 E 24.. P s . 50..	851 06 R 24.. P s . 50..	1.311 (33.30)	1.263 (32.10)	1.775 (45.10)	1.539 (39.10)

Plug with straight sealing gland backshell

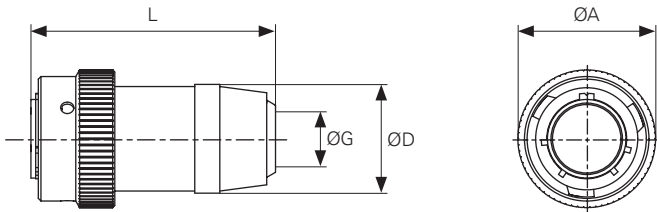

Cross reference

06 J	HE 301 B 06 J
-------------	---------------

Shell size	Part numbers		L max	crimp	Ø A	Ø D		Ø G	
	solder contacts	crimp contacts				max	min	max	
8	851 06 J 8.. P s . 50	—	1.874 (47.60)	—	0.750 (19.05)	0.567 (14.40)	0.197 (5.02)	0.230 (5.84)	
10	851 06 J 10.. P s . 50	—	1.874 (47.60)	—	0.858 (21.80)	0.693 (17.60)	0.233 (5.94)	0.266 (6.76)	
12	851 06 J 12.. P s . 50	—	1.917 (48.70)	—	1.029 (26.15)	0.830 (21.10)	0.367 (9.34)	0.400 (10.16)	
14	851 06 J 14.. P s . 50	—	2.106 (53.50)	—	1.155 (29.35)	0.960 (24.40)	0.445 (11.32)	0.478 (12.14)	
16	851 06 J 16.. P s . 50	—	2.322 (59.00)	—	1.279 (32.50)	1.086 (27.60)	0.578 (14.73)	0.612 (15.55)	
18	851 06 J 18.. P s . 50	—	2.559 (65.00)	—	1.389 (35.30)	1.212 (30.80)	0.629 (16.00)	0.662 (16.82)	
20	851 06 J 20.. P s . 50	—	3.114 (79.10)	—	1.529 (38.85)	1.342 (34.10)	0.665 (16.89)	0.697 (17.71)	
22	851 06 J 22.. P s . 50	—	3.149 (80.00)	—	1.655 (42.05)	1.468 (37.30)	0.700 (17.78)	0.732 (18.60)	
24	851 06 J 24.. P s . 50	—	3.543 (90.00)	—	1.775 (45.10)	1.594 (40.50)	0.800 (20.34)	0.833 (21.16)	

Dimensions are in inches (millimeters)

Plug with straight sealing gland and cable clamp backshells

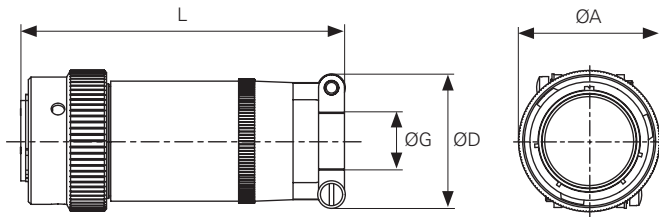

Cross reference

06 JC	MS 3116 J
--------------	-----------

Shell size	Part numbers solder contacts	crimp contacts	L max solder	crimp	A max	D max	G min	max
8	851 06 JC 8.. ^P / _s . 50..	—	2.270 (57.68)	—	0.750 (19.05)	0.783 (19.90)	0.197 (5.02)	0.230 (5.84)
10	851 06 JC 10.. ^P / _s . 50..	—	2.270 (57.68)	—	0.858 (21.80)	0.846 (21.50)	0.233 (5.94)	0.266 (6.76)
12	851 06 JC 12.. ^P / _s . 50..	—	2.411 (61.24)	—	1.029 (26.15)	0.984 (25.00)	0.367 (9.34)	0.400 (10.16)
14	851 06 JC 14.. ^P / _s . 50..	—	2.598 (66.01)	—	1.155 (29.35)	1.094 (27.80)	0.445 (11.32)	0.478 (12.14)
16	851 06 JC 16.. ^P / _s . 50..	—	2.943 (74.75)	—	1.279 (32.50)	1.157 (29.40)	0.578 (14.73)	0.612 (15.55)
18	851 06 JC 18.. ^P / _s . 50..	—	3.172 (80.57)	—	1.389 (35.30)	1.389 (35.30)	0.629 (16.00)	0.662 (16.82)
20	851 06 JC 20.. ^P / _s . 50..	—	3.609 (91.69)	—	1.529 (38.85)	1.389 (35.30)	0.665 (16.89)	0.696 (17.70)
22	851 06 JC 22.. ^P / _s . 50..	—	3.766 (95.66)	—	1.655 (42.05)	1.618 (41.10)	0.700 (17.78)	0.732 (18.60)
24	851 06 JC 24.. ^P / _s . 50..	—	3.985 (101.22)	—	1.775 (45.10)	1.669 (42.40)	0.800 (20.34)	0.833 (21.16)

Plug with long metallic adaptor and plastic cable gland

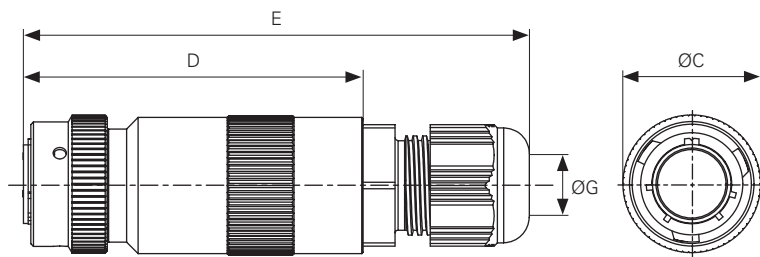

Shell size	Part numbers solder contacts	crimp contacts	L max solder	crimp	Ø A	D max	ØG min	max
8	851 06L 8 ^P / _s *	—	3.189 (81.00)	—	0.759 (19.30)	2.244 (57.00)	0.157 (4.00)	0.196 (5.00)
10	851 06L 10 ^P / _s *	—	3.307 (84.00)	—	0.866 (22.00)	2.244 (57.00)	0.157 (4.00)	0.236 (6.00)
12	851 06L 12 ^P / _s *	—	3.385 (86.00)	—	1.035 (26.30)	2.244 (57.00)	0.157 (4.00)	0.275 (7.00)
14	851 06L 14 ^P / _s *	—	3.425 (87.00)	—	1.161 (29.50)	2.244 (57.00)	0.157 (4.00)	0.354 (9.00)
16	851 06L 16 ^P / _s *	—	3.543 (90.00)	—	1.287 (32.70)	2.244 (57.00)	0.236 (6.00)	0.472 (12.00)

Note: * Specification available in black-zinc nickel or black anodized (see Page 13)

Dimensions are in inches (millimeters)

Souriau 851 series

Hermetic versions

Plug with removable straight backshell for heatshrink sleeving

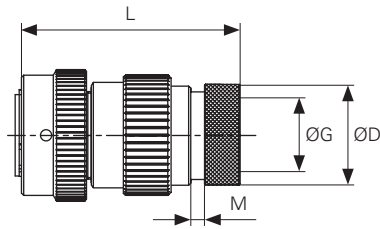

Shell size	Part numbers solder contacts	crimp contacts	L max solder	crimp	Ø A	Ø D max	Ø G max	M max
8	851 06 M 8.. ^P _s . 50..	851 06 RM 8.. ^P _s . 50..	1.668 (50.00)	1.668 (50.00)	0.750 (19.05)	0.533 (13.55)	0.277 (7.05)	0.137 (3.50)
10	851 06 M 10.. ^P _s . 50..	851 06 RM 10.. ^P _s . 50..	1.668 (50.00)	1.668 (50.00)	0.858 (21.80)	0.604 (15.35)	0.389 (9.90)	0.137 (3.50)
12	851 06 M 12.. ^P _s . 50..	851 06 RM 12.. ^P _s . 50..	1.668 (50.00)	1.668 (50.00)	1.029 (26.15)	0.766 (19.48)	0.496 (12.60)	0.137 (3.50)
14	851 06 M 14.. ^P _s . 50..	851 06 RM 14.. ^P _s . 50..	1.668 (50.00)	1.668 (50.00)	1.155 (29.35)	0.838 (21.30)	0.626 (15.90)	0.137 (3.50)
16	851 06 M 16.. ^P _s . 50..	851 06 RM 16.. ^P _s . 50..	1.668 (50.00)	1.668 (50.00)	1.279 (32.50)	0.964 (24.50)	0.746 (18.95)	0.137 (3.50)
18	851 06 M 18.. ^P _s . 50..	851 06 RM 18.. ^P _s . 50..	1.668 (50.00)	1.668 (50.00)	1.389 (35.30)	1.041 (26.45)	0.822 (20.90)	0.137 (3.50)
20	851 06 M 20.. ^P _s . 50..	851 06 RM 20.. ^P _s . 50..	2.047 (52.00)	2.047 (52.00)	1.529 (38.85)	1.209 (30.73)	0.933 (23.70)	0.137 (3.50)
22	851 06 M 22.. ^P _s . 50..	851 06 RM 22.. ^P _s . 50..	2.047 (52.00)	2.047 (52.00)	1.655 (42.05)	1.348 (34.24)	1.047 (26.60)	0.137 (3.50)
24	851 06 M 24.. ^P _s . 50..	851 06 RM 24.. ^P _s . 50..	2.047 (52.00)	2.047 (52.00)	1.775 (45.10)	1.435 (36.47)	1.153 (29.30)	0.137 (3.50)

Plug with short metallic adaptor and plastic cable gland with spiral protector

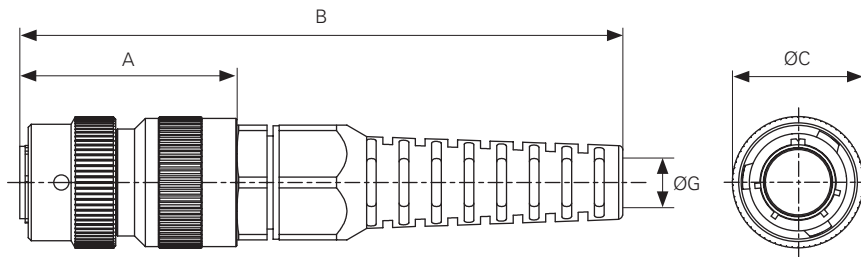

Shell size	Part numbers solder contacts	crimp contacts	L max solder	crimp	Ø A	D max	Ø G min	max
8	851 06NS 8 ^P _s *	—	3.582 (91.00)	—	0.759 (19.30)	1.456 (37.00)	0.157 (4.00)	0.256 (6.50)
10	851 06NS 10 ^P _s *	—	3.976 (101.00)	—	0.866 (22.00)	1.456 (37.00)	0.157 (4.00)	0.275 (7.00)
12	851 06NS 12 ^P _s *	—	4.488 (114.00)	—	1.035 (26.30)	1.456 (37.00)	0.157 (4.00)	0.275 (7.00)
14	851 06NS 14 ^P _s *	—	4.921 (125.00)	—	1.161 (29.50)	1.456 (37.00)	0.157 (4.00)	0.275 (7.00)
16	851 06NS 16 ^P _s *	—	5.669 (144.00)	—	1.287 (32.70)	1.653 (42.00)	0.236 (6.00)	0.433 (11.00)

Note: * Specification available in black-zinc nickel or black anodized (see Page 13)

Dimensions are in inches (millimeters)

Plug with long metallic adaptor and plastic cable gland with spiral protector

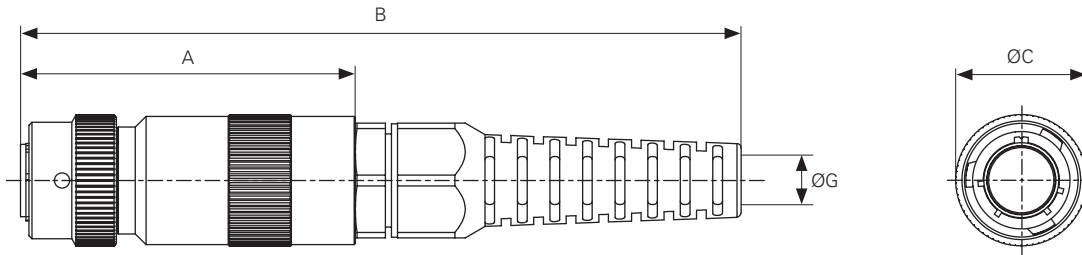

Shell size	Part numbers solder contacts	crimp contacts	L max solder	crimp	Ø A	D max	Ø G min	max
8	851 06NL 8.. ^P _s . 50..	–	4.370 (111.00)	–	0.759 (19.30)	2.244 (57.00)	0.157 (4.00)	0.256 (6.50)
10	851 06NL 10.. ^P _s . 50..	–	4.763 (121.00)	–	0.866 (22.00)	2.244 (57.00)	0.157 (4.00)	0.275 (7.00)
12	851 06NL 12.. ^P _s . 50..	–	5.275 (134.00)	–	1.035 (26.30)	2.244 (57.00)	0.157 (4.00)	0.275 (7.00)
14	851 06NL 14.. ^P _s . 50..	–	5.708 (145.00)	–	1.161 (29.50)	2.244 (57.00)	0.157 (4.00)	0.275 (7.00)
16	851 06NL 16.. ^P _s . 50..	–	6.259 (159.00)	–	1.287 (32.70)	2.244 (57.00)	0.236 (6.00)	0.433 (11.00)

Note: * Specification available in black-zinc nickel or black anodized (see Page 13)

Plug with straight backshell for potting

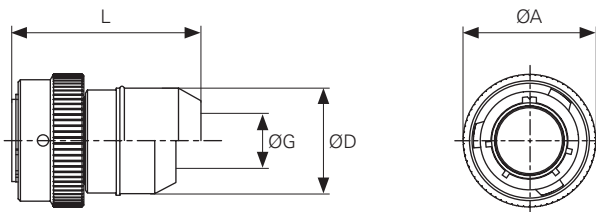

Cross reference

06 P	HE 301 B 06 P
	MS 3116 P
06 RP	HE 301 B 06 RP
	MS 3126 P

Shell size	Part numbers solder contacts	crimp contacts	L max solder	crimp	Ø A	Ø D max	Ø G
8	851 06 P 8.. ^P _s . 50..	851 06 RP 8.. ^P _s . 50..	1.425 (36.20)	1.657 (42.10)	0.750 (19.05)	0.604 (15.34)	0.411 (10.46)
10	851 06 P 10.. ^P _s . 50..	851 06 RP 10.. ^P _s . 50..	1.425 (36.20)	1.657 (42.10)	0.858 (21.80)	0.696 (17.70)	0.533 (13.55)
12	851 06 P 12.. ^P _s . 50..	851 06 RP 12.. ^P _s . 50..	1.425 (36.20)	1.657 (42.10)	1.029 (26.15)	0.854 (21.69)	0.549 (13.96)
14	851 06 P 14.. ^P _s . 50..	851 06 RP 14.. ^P _s . 50..	1.425 (36.20)	1.657 (42.10)	1.155 (29.35)	0.940 (23.90)	0.685 (17.42)
16	851 06 P 16.. ^P _s . 50..	851 06 RP 16.. ^P _s . 50..	1.425 (36.20)	1.657 (42.10)	1.279 (32.50)	1.063 (27.00)	0.809 (20.56)
18	851 06 P 18.. ^P _s . 50..	851 06 RP 18.. ^P _s . 50..	1.484 (37.70)	1.787 (45.40)	1.389 (35.30)	1.200 (30.50)	0.931 (23.66)
20	851 06 P 20.. ^P _s . 50..	851 06 RP 20.. ^P _s . 50..	1.669 (42.40)	1.668 (50.00)	1.529 (38.85)	1.324 (33.65)	0.941 (23.92)
22	851 06 P 22.. ^P _s . 50..	851 06 RP 22.. ^P _s . 50..	1.669 (42.40)	1.668 (50.00)	1.655 (42.05)	1.460 (37.10)	1.004 (25.52)
24	851 06 P 24.. ^P _s . 50..	851 06 RP 24.. ^P _s . 50..	1.687 (42.85)	1.668 (50.00)	1.775 (45.10)	1.574 (40.00)	1.259 (32.00)

Dimensions are in inches (millimeters)

Souriau 851 series

Hermetic versions

Plug with short metallic adaptor and plastic cable gland

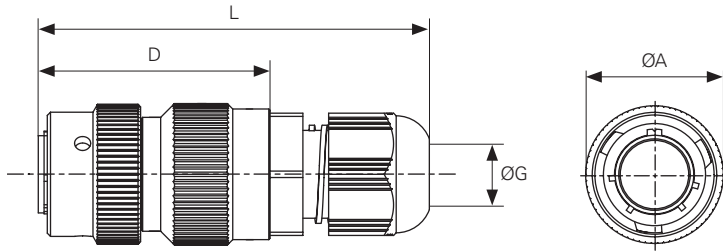

Shell size	Part numbers solder contacts	crimp contacts	L max solder	crimp	Ø A max	D max	Ø G min	max
8	851 06S 8 ^P s *	–	2.401 (61.00)	–	0.759 (19.30)	1.456 (37.00)	0.157 (4.00)	5.00
10	851 06S 10 ^P s *	–	2.519 (64.00)	–	0.866 (22.00)	1.456 (37.00)	0.157 (4.00)	6.00
12	851 06S 12 ^P s *	–	2.598 (66.00)	–	1.035 (26.30)	1.456 (37.00)	0.157 (4.00)	7.00
14	851 06S 14 ^P s *	–	2.637 (67.00)	–	1.161 (29.50)	1.456 (37.00)	0.157 (4.00)	9.00
16	851 06S 16 ^P s *	–	2.952 (75.00)	–	1.287 (32.70)	1.653 (42.00)	0.236 (6.00)	12.00

Note: * Specification available in black-zinc nickel or black anodized (see Page 13)

Plug with straight backshell for heatshrink sleeving

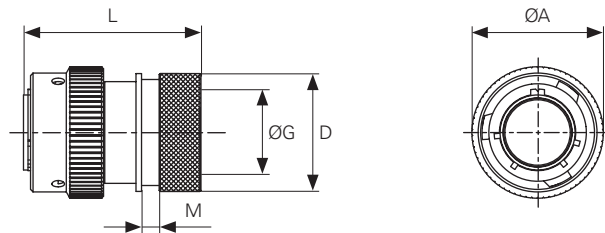

Cross reference

06 T	–
06 RT	VG 95328 J

Shell size	Part numbers solder contacts	crimp contacts	L max solder	crimp	Ø A	Ø D max	G min	max	M max
8	851 06 T 8.. ^P s . 50..	851 06 RT 8.. ^P s . 50..	1.444 (36.70)	1.417 (36.00)	0.750 (19.05)	0.604 (15.35)	0.283 (7.20)	0.263 (6.70)	0.145 (3.70)
10	851 06 T 10.. ^P s . 50..	851 06 RT 10.. ^P s . 50..	1.444 (36.70)	1.417 (36.00)	0.858 (21.80)	0.714 (18.15)	0.401 (10.20)	0.370 (9.40)	0.145 (3.70)
12	851 06 T 12.. ^P s . 50..	851 06 RT 12.. ^P s . 50..	1.444 (36.70)	1.417 (36.00)	1.029 (26.15)	0.923 (23.45)	0.519 (13.20)	0.460 (11.95)	0.145 (3.70)
14	851 06 T 14.. ^P s . 50..	851 06 RT 14.. ^P s . 50..	1.444 (36.70)	1.417 (36.00)	1.155 (29.35)	0.954 (24.25)	0.633 (16.10)	0.596 (15.15)	0.145 (3.70)
16	851 06 T 16.. ^P s . 50..	851 06 RT 16.. ^P s . 50..	1.535 (39.00)	1.507 (38.30)	1.279 (32.50)	1.163 (29.55)	0.757 (19.25)	0.710 (18.05)	0.145 (3.70)
18	851 06 T 18.. ^P s . 50..	851 06 RT 18.. ^P s . 50..	1.535 (39.00)	1.507 (38.30)	1.389 (35.30)	1.250 (31.75)	0.838 (21.30)	0.785 (19.95)	0.145 (3.70)
20	851 06 T 20.. ^P s . 50..	851 06 RT 20.. ^P s . 50..	1.732 (44.00)	1.688 (42.90)	1.529 (38.85)	1.411 (35.85)	0.960 (24.40)	0.907 (23.05)	0.145 (3.70)
22	851 06 T 22.. ^P s . 50..	851 06 RT 22.. ^P s . 50..	1.732 (44.00)	1.688 (42.90)	1.655 (42.05)	1.503 (38.20)	1.082 (27.50)	1.006 (25.55)	0.145 (3.70)
24	851 06 T 24.. ^P s . 50..	851 06 RT 24.. ^P s . 50..	1.681 (41.60)	1.637 (41.60)	1.775 (45.10)	1.626 (41.30)	1.204 (30.60)	1.127 (28.65)	0.145 (3.70)

Dimensions are in inches (millimeters)

Plug with straight adaptor for electrical pitch access

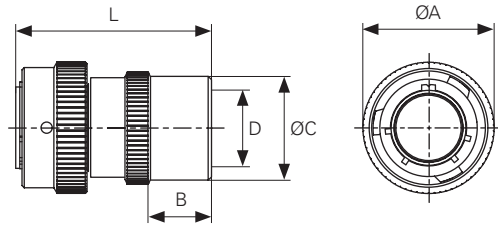

The Z type special adaptor equips crimp plug 851 06 RZ fits following accessories:

- Packing gland collet backshell
- Backshell for polyflex sleeving
- Backshell for C.N.O.M.O. tube

Shell size	Part numbers solder contacts	Part numbers crimp contacts	L max solder	L max crimp	Ø A max	B max	Ø D max	G threading PE
8	-	-	-	-	-	-	-	-
10	-	-	-	-	-	-	-	-
12	851 06 Z 12.. P s . 50..	851 06 RZ 12.. P s . 50..	1.693 (43.00)	1.693 (43.00)	1.029 (26.15)	0.358 (9.10)	0.976 (24.80)	0.433 (11.00)
14	851 06 Z 14.. P s . 50..	851 06 RZ 14.. P s . 50..	1.771 (45.00)	1.771 (45.00)	1.155 (29.35)	0.433 (11.00)	1.133 (28.80)	0.629 (16.00)
16	851 06 Z 16.. P s . 50..	851 06 RZ 16.. P s . 50..	1.771 (45.00)	1.771 (45.00)	1.279 (32.50)	0.433 (11.00)	1.212 (30.80)	0.629 (16.00)
18	851 06 Z 18.. P s . 50..	851 06 RZ 18.. P s . 50..	1.811 (46.00)	1.811 (46.00)	1.389 (35.30)	0.472 (12.00)	1.606 (40.80)	0.826 (21.00)
20	851 06 Z 20.. P s . 50..	851 06 RZ 20.. P s . 50..	1.830 (46.50)	1.830 (46.50)	1.529 (38.85)	0.472 (12.00)	1.606 (40.80)	0.826 (21.00)
22	851 06 Z 22.. P s . 50..	851 06 RZ 22.. P s . 50..	1.830 (46.50)	1.830 (46.50)	1.655 (42.05)	0.472 (12.00)	1.606 (40.80)	0.826 (21.00)
24	851 06 Z 24.. P s . 50..	851 06 RZ 24.. P s . 50..	2.578 (65.50)	2.578 (65.50)	1.775 (45.10)	1.236 (31.40)	1.771 (45.00)	1.141 (29.00)

Plug with elbow cable clamp backshell

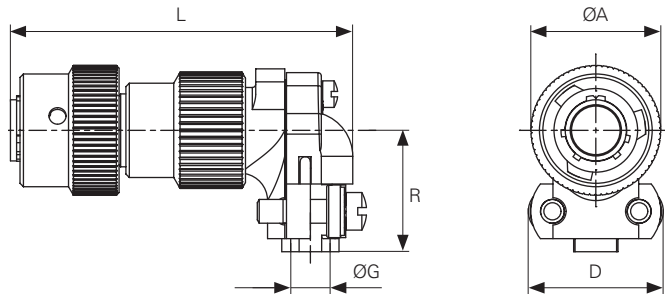

Cross reference

08 EC	HE 301 B 08 EC
08 RC	HE 301 B 08 RC

Shell size	Part numbers solder contacts	Part numbers crimp contacts	L max solder	L max crimp	Ø A max	D max	Ø G	R max
8	851 08 EC 8.. P s . 50..	851 08 RC 8.. P s . 50..	1.972 (50.10)	1.972 (50.10)	0.750 (19.05)	0.775 (19.70)	0.137 (3.50)	0.629 (16.00)
10	851 08 EC 10.. P s . 50..	851 08 RC 10.. P s . 50..	2.070 (52.60)	2.070 (52.60)	0.858 (21.80)	0.834 (21.20)	0.196 (5.00)	0.708 (18.00)
12	851 08 EC 12.. P s . 50..	851 08 RC 12.. P s . 50..	2.161 (54.90)	2.161 (54.90)	1.029 (26.15)	0.952 (24.20)	0.322 (8.20)	0.767 (19.50)
14	851 08 EC 14.. P s . 50..	851 08 RC 14.. P s . 50..	2.303 (58.50)	2.303 (58.50)	1.155 (29.35)	1.082 (27.50)	0.393 (10.00)	0.866 (22.00)
16	851 08 EC 16.. P s . 50..	851 08 RC 16.. P s . 50..	2.393 (60.80)	2.393 (60.80)	1.279 (32.50)	1.145 (29.10)	0.511 (13.00)	0.925 (23.50)
18	851 08 EC 18.. P s . 50..	851 08 RC 18.. P s . 50..	2.559 (65.00)	2.559 (65.00)	1.389 (35.30)	1.405 (35.70)	0.629 (16.00)	0.984 (25.00)
20	851 08 EC 20.. P s . 50..	851 08 RC 20.. P s . 50..	2.720 (69.10)	2.720 (69.10)	1.529 (38.85)	1.405 (35.70)	0.629 (16.00)	1.043 (26.50)
22	851 08 EC 22.. P s . 50..	851 08 RC 22.. P s . 50..	2.795 (71.00)	2.795 (71.00)	1.655 (42.05)	1.563 (39.70)	0.759 (19.30)	1.102 (28.00)
24	851 08 EC 24.. P s . 50..	851 08 RC 24.. P s . 50..	2.972 (75.50)	2.972 (75.50)	1.775 (45.10)	1.7121 (43.50)	0.811 (20.60)	1.220 (31.00)

Dimensions are in inches (millimeters)

Souriau 851 series

Hermetic versions

Plug with elbow backshell for potting

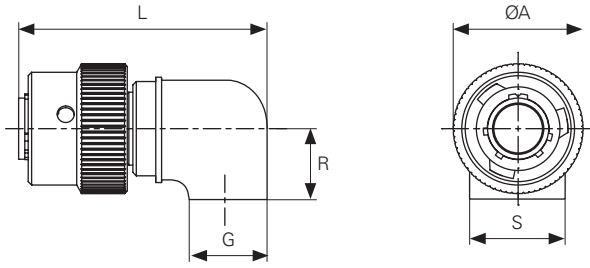

Cross reference

08 P	HE 301 B 08 P
08 RP	HE 301 B 08 RP

Shell size	Part numbers		L max		Ø A max	G max	R max	S max
	solder contacts	crimp contacts	solder	crimp				
8	851 08 P 8.. ^P _s . 50..	851 08 RP 8.. ^P _s . 50..	1.602 (40.70)	1.602 (40.70)	0.750 (19.05)	0.319 (8.10)	0.451 (11.70)	0.444 (11.30)
10	851 08 P 10.. ^P _s . 50..	851 08 RP 10.. ^P _s . 50..	1.767 (44.90)	1.767 (44.90)	0.858 (21.80)	0.444 (11.30)	0.565 (14.35)	0.570 (14.50)
12	851 08 P 12.. ^P _s . 50..	851 08 RP 12.. ^P _s . 50..	1.846 (46.90)	1.846 (46.90)	1.029 (26.15)	0.523 (13.30)	0.626 (15.90)	0.696 (17.70)
14	851 08 P 14.. ^P _s . 50..	851 08 RP 14.. ^P _s . 50..	1.937 (49.20)	1.937 (49.20)	1.155 (29.35)	0.633 (16.10)	0.641 (16.30)	0.791 (20.10)
16	851 08 P 16.. ^P _s . 50..	851 08 RP 16.. ^P _s . 50..	1.992 (50.60)	1.992 (50.60)	1.279 (32.50)	0.665 (16.90)	0.759 (19.30)	0.897 (22.80)
18	851 08 P 18.. ^P _s . 50..	851 08 RP 18.. ^P _s . 50..	2.039 (51.80)	2.039 (51.80)	1.389 (35.30)	0.712 (18.10)	0.811 (20.60)	1.007 (25.60)
20	851 08 P 20.. ^P _s . 50..	851 08 RP 20.. ^P _s . 50..	2.114 (53.70)	2.114 (53.70)	1.529 (38.85)	19.70 (19.70)	0.862 (21.90)	1.133 (28.80)
22	851 08 P 22.. ^P _s . 50..	851 08 RP 22.. ^P _s . 50..	2.157 (54.80)	2.157 (54.80)	1.655 (42.05)	0.819 (20.80)	0.925 (23.50)	1.244 (31.60)
24	851 08 P 24.. ^P _s . 50..	851 08 RP 24.. ^P _s . 50..	2.291 (58.20)	2.291 (58.20)	1.775 (45.10)	0.952 (24.20)	30.15 (30.15)	1.385 (35.20)

Shielded plug with straight adaptor

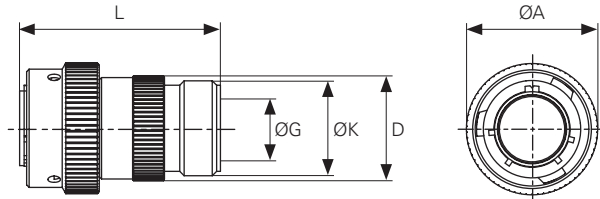

Cross reference

36 A	–
36 RA	VG 95328 N

Shell size	Part numbers		L max		Ø A max	Ø D max	Ø G max	K threading UNEF 2A
	solder contacts	crimp contacts	solder	crimp				
8	851 36 A 8.. ^P _s . 50..	851 36 RA 8.. ^P _s . 50..	1.614 (41.00)	1.614 (41.00)	0.750 (19.05)	0.570 (14.50)	0.358 (9.10)	1/2 28
10	851 36 A 10.. ^P _s . 50..	851 36 RA 10.. ^P _s . 50..	1.614 (41.00)	1.614 (41.00)	0.858 (21.80)	0.736 (18.70)	0.475 (12.08)	5/8 24
12	851 36 A 12.. ^P _s . 50..	851 36 RA 12.. ^P _s . 50..	1.614 (41.00)	1.614 (41.00)	1.029 (26.15)	0.854 (21.70)	0.600 (15.25)	3/4 20
14	851 36 A 14.. ^P _s . 50..	851 36 RA 14.. ^P _s . 50..	1.614 (41.00)	1.614 (41.00)	1.155 (29.35)	0.988 (25.0)	0.714 (18.15)	7/8 20
16	851 36 A 16.. ^P _s . 50..	851 36 RA 16.. ^P _s . 50..	1.614 (41.00)	1.614 (41.00)	1.279 (32.50)	1.107 (28.13)	0.839 (21.32)	1-20
18	851 36 A 18.. ^P _s . 50..	851 36 RA 18.. ^P _s . 50..	1.614 (41.00)	1.614 (41.00)	1.389 (35.30)	1.235 (31.38)	0.957 (24.32)	1-3/16 18
20	851 36 A 20.. ^P _s . 50..	851 36 RA 20.. ^P _s . 50..	1.704 (43.30)	1.704 (43.30)	1.529 (38.85)	1.350 (34.30)	1.052 (26.73)	1-3/16 18
22	851 36 A 22.. ^P _s . 50..	851 36 RA 22.. ^P _s . 50..	1.704 (43.30)	1.704 (43.30)	1.655 (42.05)	1.480 (37.60)	1.207 (30.67)	1-7/16 18
24	851 36 A 24.. ^P _s . 50..	851 36 RA 24.. ^P _s . 50..	1.7121 (43.50)	1.7121 (43.50)	1.775 (45.10)	1.602 (40.70)	1.302 (33.08)	1-7/16 18

Dimensions are in inches (millimeters)

Shielded plug with removable straight backshell for screen termination and heatshrink sleeving

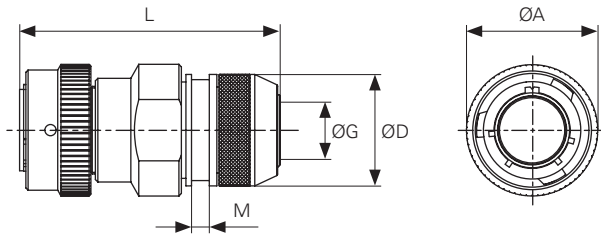

Cross reference

36 G	–
36 RG	VG 95328 M

Shell size	Part numbers solder contacts	Part numbers crimp contacts	L max solder	L max crimp	Ø A max	Ø D max	Ø G max	M max
8	851 36 G 8 .. P s . 50..	851 36 RG 8 .. P s . 50..	2.126 (54.00)	2.126 (54.00)	0.750 (19.05)	0.641 (16.30)	0.293 (7.45)	0.141 (3.60)
10	851 36 G 10 .. P s . 50..	851 36 RG 10 .. P s . 50..	2.126 (54.00)	2.126 (54.00)	0.858 (21.80)	0.720 (18.30)	0.405 (10.30)	0.141 (3.60)
12	851 36 G 12 .. P s . 50..	851 36 RG 12 .. P s . 50..	2.126 (54.00)	2.126 (54.00)	1.029 (26.15)	0.878 (22.30)	0.519 (13.20)	0.141 (3.60)
14	851 36 G 14 .. P s . 50..	851 36 RG 14 .. P s . 50..	2.126 (54.00)	2.126 (54.00)	1.155 (29.35)	0.996 (25.30)	0.649 (16.50)	0.141 (3.60)
16	851 36 G 16 .. P s . 50..	851 36 RG 16 .. P s . 50..	2.126 (54.00)	2.126 (54.00)	1.279 (32.50)	1.114 (28.30)	0.761 (19.35)	0.141 (3.60)
18	851 36 G 18 .. P s . 50..	851 36 RG 18 .. P s . 50..	2.126 (54.00)	2.126 (54.00)	1.389 (35.30)	1.271 (32.30)	0.850 (21.60)	0.141 (3.60)
20	851 36 G 20 .. P s . 50..	851 36 RG 20 .. P s . 50..	2.283 (58.00)	2.283 (58.00)	1.529 (38.85)	1.350 (34.30)	0.976 (24.80)	0.141 (3.60)
22	851 36 G 22 .. P s . 50..	851 36 RG 22 .. P s . 50..	2.283 (58.00)	2.283 (58.00)	1.655 (42.05)	1.507 (38.30)	1.098 (27.90)	0.141 (3.60)
24	851 36 G 24 .. P s . 50..	851 36 RG 24 .. P s . 50..	2.283 (58.00)	2.283 (58.00)	1.775 (45.10)	1.626 (41.30)	1.220 (31.00)	0.141 (3.60)

Shielded plug with removable straight backshell for screen termination and heatshrink sleeving (38 & 42 suffix)

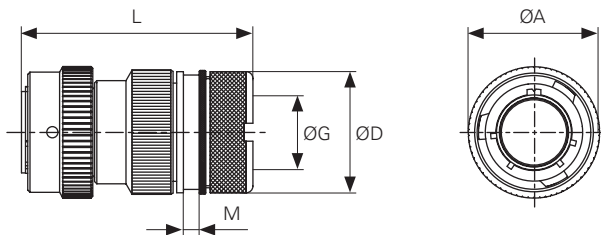

Shell size	Part numbers solder contacts	Part numbers crimp contacts	L max solder	L max crimp	Ø A max	Ø D max	Ø G max	M max
8	851 36 T 8 .. P s . 50..	851 36 RT 8 .. P s . 50..	2.031 (51.60)	2.031 (51.60)	0.750 (19.05)	0.718 (18.25)	0.293 (7.45)	0.145 (3.70)
10	851 36 T 10 .. P s . 50..	851 36 RT 10 .. P s . 50..	2.031 (51.60)	2.031 (51.60)	0.858 (21.80)	0.797 (20.25)	0.354 (9.00)	0.145 (3.70)
12	851 36 T 12 .. P s . 50..	851 36 RT 12 .. P s . 50..	2.031 (51.60)	2.031 (51.60)	1.029 (26.15)	0.974 (24.75)	0.523 (13.30)	0.145 (3.70)
14	851 36 T 14 .. P s . 50..	851 36 RT 14 .. P s . 50..	2.031 (51.60)	2.031 (51.60)	1.155 (29.35)	1.092 (27.75)	0.649 (16.50)	0.145 (3.70)
16	851 36 T 16 .. P s . 50..	851 36 RT 16 .. P s . 50..	2.031 (51.60)	2.031 (51.60)	1.279 (32.50)	1.183 (30.05)	0.728 (18.50)	0.145 (3.70)
18	851 36 T 18 .. P s . 50..	851 36 RT 18 .. P s . 50..	2.047 (52.00)	2.047 (52.00)	1.389 (35.30)	1.344 (34.15)	0.862 (21.90)	0.145 (3.70)
20	851 36 T 20 .. P s . 50..	851 36 RT 20 .. P s . 50..	2.122 (53.90)	2.122 (53.90)	1.529 (38.85)	1.466 (37.25)	0.988 (25.10)	0.145 (3.70)
22	851 36 T 22 .. P s . 50..	851 36 RT 22 .. P s . 50..	2.122 (53.90)	2.122 (53.90)	1.655 (42.05)	1.592 (40.45)	1.110 (28.20)	0.145 (3.70)
24	851 36 T 24 .. P s . 50..	851 36 RT 24 .. P s . 50..	2.122 (53.90)	2.122 (53.90)	1.775 (45.10)	1.718 (43.65)	1.236 (31.40)	0.145 (3.70)

Dimensions are in inches (millimeters)

Souriau 851 series

Hermetic connectors

Square flange receptacle

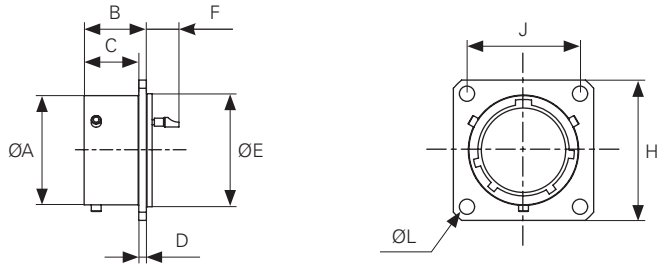

Cross reference

02 H	HE 301 B 02 H
-------------	---------------

Shell size	Part numbers	Ø A max	B	C max	D max	Ø E	F max	H max	J	Ø L
8	851 02 H 8.. P s . 50..	0.473 (12.03)	0.544 (13.84)	0.442 (11.24)	0.061 (1.55)	0.561 (14.27)	0.295 (7.5)	0.827 (21.03)	0.594 (15.09)	0.124 (3.15)
10	851 02 H 10.. P s . 50..	0.590 (15.01)	0.544 (13.84)	0.442 (11.24)	0.061 (1.55)	0.672 (17.07)	0.295 (7.5)	0.954 (24.23)	0.718 (18.26)	0.124 (3.15)
12	851 02 H 12.. P s . 50..	0.750 (19.07)	0.544 (13.84)	0.442 (11.24)	0.061 (1.55)	0.781 (19.84)	0.295 (7.5)	1.046 (26.59)	0.811 (20.62)	0.124 (3.15)
14	851 02 H 14.. P s . 50..	0.876 (22.25)	0.544 (13.84)	0.442 (11.24)	0.061 (1.55)	0.906 (23.01)	0.295 (7.5)	1.141 (28.98)	0.905 (23.00)	0.124 (3.15)
16	851 02 H 16.. P s . 50..	1.000 (25.42)	0.544 (13.84)	0.442 (11.24)	0.061 (1.55)	1.031 (26.19)	0.295 (7.5)	1.233 (31.34)	0.968 (24.61)	0.124 (3.15)
18	851 02 H 18.. P s . 50..	1.126 (28.60)	0.544 (13.84)	0.442 (11.24)	0.061 (1.55)	1.156 (29.36)	0.295 (7.5)	1.327 (33.73)	1.061 (26.97)	0.124 (3.15)
20	851 02 H 20.. P s . 50..	1.250 (31.77)	0.607 (15.42)	0.472 (12.00)	0.092 (2.36)	1.250 (31.75)	0.295 (7.5)	1.453 (36.91)	1.156 (29.36)	0.124 (3.15)
22	851 02 H 22.. P s . 50..	1.376 (34.95)	0.639 (16.23)	0.472 (12.00)	0.092 (2.36)	1.374 (34.92)	0.295 (7.5)	1.578 (40.10)	1.250 (31.75)	0.124 (3.15)
24	851 02 H 24.. P s . 50..	1.500 (38.12)	0.670 (17.04)	0.504 (12.81)	0.092 (2.36)	1.500 (38.10)	0.263 (6.7)	1.703 (43.27)	1.374 (34.92)	0.150 (3.82)

Jam nut receptacle

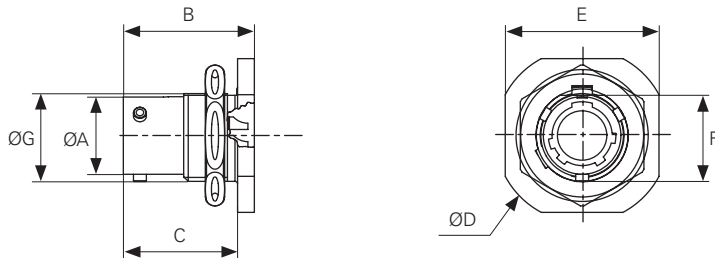

Cross reference

07 H	HE 301 B 07 H
	MS 3114 H
	VG 95328 F

Shell size	Part numbers	Ø A max	B max	C max	Ø D max	E max	F	Ø G max
8	851 07 H 8.. P s . 50..	0.473 (12.03)	0.811 (20.60)	0.706 (17.93)	1.077 (27.37)	0.947 (24.07)	0.524 (13.33)	0.561 (14.26)
10	851 07 H 10.. P s . 50..	0.590 (15.01)	0.811 (20.60)	0.706 (17.93)	1.203 (30.57)	1.071 (27.22)	0.650 (16.51)	0.686 (17.43)
12	851 07 H 12.. P s . 50..	0.750 (19.07)	0.811 (20.60)	0.706 (17.93)	1.390 (35.32)	1.259 (32.00)	0.812 (20.63)	0.873 (22.19)
14	851 07 H 14.. P s . 50..	0.876 (22.25)	0.811 (20.60)	0.706 (17.93)	1.515 (38.50)	1.384 (35.17)	0.936 (23.78)	0.998 (25.36)
16	851 07 H 16.. P s . 50..	1.000 (25.42)	0.811 (20.60)	0.706 (17.93)	1.640 (41.67)	1.509 (38.35)	1.060 (26.93)	1.123 (28.54)
18	851 07 H 18.. P s . 50..	1.126 (28.60)	0.811 (20.60)	0.706 (17.93)	1.765 (44.85)	1.634 (41.52)	1.185 (30.10)	1.248 (31.71)
20	851 07 H 20.. P s . 50..	1.250 (31.77)	1.029 (26.15)	0.884 (22.70)	1.953 (49.62)	1.821 (46.27)	1.310 (33.28)	1.373 (34.89)
22	851 07 H 22.. P s . 50..	1.376 (34.95)	1.029 (26.15)	0.884 (22.70)	2.077 (52.77)	1.947 (49.47)	1.435 (36.45)	1.498 (38.06)
24	851 07 H 24.. P s . 50..	1.500 (38.12)	1.062 (26.98)	0.926 (23.54)	2.203 (55.97)	2.071 (52.62)	1.560 (39.63)	1.623 (41.24)

Dimensions are in inches (millimeters)

Solder fixing receptacle

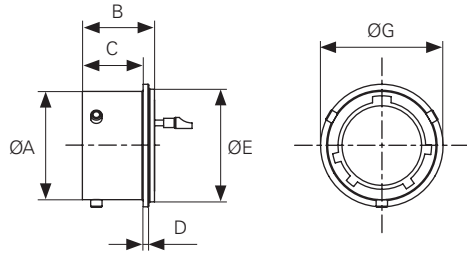

Cross reference

IH	HE 301 B 1H
	MS 3113 H
	VG 95328 G

Shell size	Part numbers	Ø A max	B	C max	D max	Ø E	F max	G max
8	851 02 IH 8.. P s . 50..	0.473 (12.03)	0.544 (13.84)	0.421 (10.70)	0.031 (0.80)	0.561 (14.27)	0.338 (8.60)	0.645 (16.40)
10	851 02 IH 10.. P s . 50..	0.590 (15.01)	0.544 (13.84)	0.421 (10.70)	0.031 (0.80)	0.672 (17.07)	0.338 (8.60)	0.763 (19.40)
12	851 02 IH 12.. P s . 50..	0.750 (19.07)	0.544 (13.84)	0.421 (10.70)	0.031 (0.80)	0.781 (19.84)	0.338 (8.60)	0.858 (21.80)
14	851 02 IH 14.. P s . 50..	0.876 (22.25)	0.544 (13.84)	0.421 (10.70)	0.031 (0.80)	0.906 (23.01)	0.338 (8.60)	0.984 (25.00)
16	851 02 IH 16.. P s . 50..	1.000 (25.42)	0.544 (13.84)	0.421 (10.70)	0.031 (0.80)	1.031 (26.19)	0.338 (8.60)	1.106 (28.10)
18	851 02 IH 18.. P s . 50..	1.126 (28.60)	0.544 (13.84)	0.421 (10.70)	0.031 (0.80)	1.156 (29.36)	0.338 (8.60)	1.232 (31.30)
20	851 02 IH 20.. P s . 50..	1.250 (31.77)	0.607 (15.42)	0.500 (12.70)	0.031 (0.80)	1.250 (31.75)	0.338 (8.60)	1.326 (33.70)
22	851 02 IH 22.. P s . 50..	1.376 (34.95)	0.639 (16.23)	0.500 (12.70)	0.031 (0.80)	1.374 (34.92)	0.338 (8.60)	1.452 (36.90)
24	851 02 IH 24.. P s . 50..	1.500 (38.12)	0.670 (17.04)	0.515 (13.10)	0.031 (0.80)	1.500 (38.10)	0.307 (7.80)	1.578 (40.10)

Dimensions are in inches (millimeters)

Souriau 851 series

PC tail connectors

Square flange receptacle

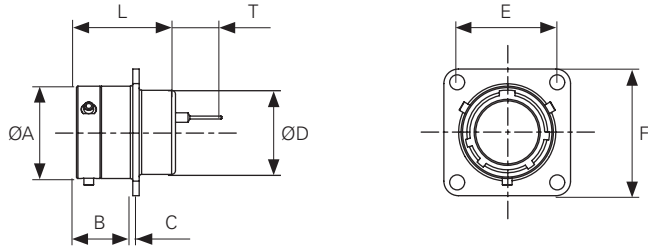

Shell size	Part numbers	Ø A max	B max	C max	Ø D max	E	F max	Ø J	L max	T
8	851 02 E 8.. ^P S . 50.. ¹⁶ 40	0.473 (12.03)	0.451 (11.70)	0.051 (1.32)	0.426 (10.84)	0.594 (15.09)	0.826 (20.99)	0.123 (3.13)	0.807 (20.50)	0.372 (9.46)
10	851 02 E 10.. ^P S . 50.. ¹⁶ 40	0.590 (15.01)	0.451 (11.70)	0.051 (1.32)	0.550 (13.99)	0.718 (18.26)	0.952 (24.19)	0.123 (3.13)	0.807 (20.50)	0.372 (9.46)
12	851 02 E 12.. ^P S . 50.. ¹⁶ 40	0.750 (19.07)	0.451 (11.70)	0.051 (1.32)	0.683 (17.37)	0.811 (20.62)	1.044 (26.54)	0.123 (3.13)	0.807 (20.50)	0.372 (9.46)
14	851 02 E 14.. ^P S . 50.. ¹⁶ 40	0.876 (22.25)	0.451 (11.70)	0.051 (1.32)	0.809 (20.57)	0.905 (23.00)	1.137 (28.89)	0.123 (3.13)	0.807 (20.50)	0.372 (9.46)
16	851 02 E 16.. ^P S . 50.. ¹⁶ 40	1.000 (25.42)	0.451 (11.70)	0.051 (1.32)	0.930 (23.62)	0.968 (24.61)	1.231 (31.29)	0.123 (3.13)	0.807 (20.50)	0.372 (9.46)
18	851 02 E 18.. ^P S . 50.. ¹⁶ 40	1.126 (28.60)	0.451 (11.70)	0.051 (1.32)	1.050 (26.69)	1.061 (26.97)	1.326 (33.69)	0.123 (3.13)	0.807 (20.50)	0.372 (9.46)
20	851 02 E 20.. ^P S . 50.. ¹⁶ 40	1.250 (31.77)	0.565 (14.35)	0.084 (2.15)	1.176 (29.89)	1.156 (29.36)	1.452 (36.89)	0.123 (3.13)	0.938 (23.80)	0.305 (7.76)
22	851 02 E 22.. ^P S . 50.. ¹⁶ 40	1.376 (34.95)	0.565 (14.35)	0.084 (2.15)	1.300 (33.04)	1.250 (31.75)	1.574 (39.99)	0.123 (3.13)	0.938 (23.80)	0.305 (7.76)
24	851 02 E 24.. ^P S . 50.. ¹⁶ 40	1.500 (38.12)	0.598 (15.20)	0.084 (2.15)	1.426 (36.24)	1.374 (34.92)	1.698 (43.15)	0.150 (3.81)	0.938 (23.80)	0.305 (7.76)

Jam nut receptacle

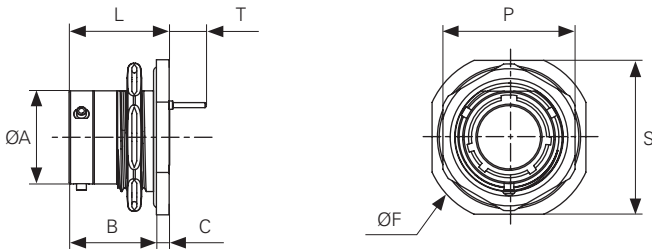

Shell size	Part numbers	Ø A max	B max	C max	Ø F max	L max	P max	S max	T
8	851 07 A 8.. ^P S . 50.. ¹⁶ 40	0.473 (12.03)	0.704 (17.90)	0.104 (2.64)	1.060 (26.94)	0.812 (20.64)	0.759 (19.29)	0.942 (23.94)	0.372 (9.46)
10	851 07 A 10.. ^P S . 50.. ¹⁶ 40	0.590 (15.01)	0.704 (17.90)	0.104 (2.64)	1.186 (30.14)	0.812 (20.64)	0.881 (22.38)	1.061 (26.95)	0.372 (9.46)
12	851 07 A 12.. ^P S . 50.. ¹⁶ 40	0.750 (19.07)	0.704 (17.90)	0.104 (2.64)	1.375 (34.94)	0.812 (20.64)	1.068 (27.13)	1.249 (31.74)	0.372 (9.46)
14	851 07 A 14.. ^P S . 50.. ¹⁶ 40	0.876 (22.25)	0.704 (17.90)	0.104 (2.64)	1.497 (38.04)	0.812 (20.64)	1.194 (30.33)	1.375 (34.94)	0.372 (9.46)
16	851 07 A 16.. ^P S . 50.. ¹⁶ 40	1.000 (25.42)	0.704 (17.90)	0.104 (2.64)	1.624 (41.26)	0.812 (20.64)	1.318 (33.48)	1.505 (38.24)	0.372 (9.46)
18	851 07 A 18.. ^P S . 50.. ¹⁶ 40	1.126 (28.60)	0.704 (17.90)	0.104 (2.64)	1.749 (44.44)	0.812 (20.64)	1.444 (36.68)	1.627 (41.34)	0.372 (9.46)
20	851 07 A 20.. ^P S . 50.. ¹⁶ 40	1.250 (31.77)	0.883 (22.45)	0.135 (3.44)	1.934 (49.14)	1.023 (25.99)	1.568 (39.83)	1.812 (46.04)	0.334 (8.49)
22	851 07 A 22.. ^P S . 50.. ¹⁶ 40	1.376 (34.95)	0.883 (22.45)	0.135 (3.44)	2.056 (52.24)	1.023 (25.99)	1.694 (43.03)	1.938 (49.24)	0.334 (8.49)
24	851 07 A 24.. ^P S . 50.. ¹⁶ 40	1.500 (38.12)	0.917 (23.30)	0.135 (3.44)	2.186 (55.54)	1.056 (26.84)	1.818 (46.18)	2.076 (52.74)	0.306 (7.79)

Dimensions in inches (millimeters)

Receptacle

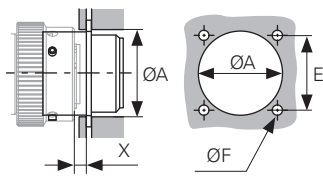

Square flange receptacle

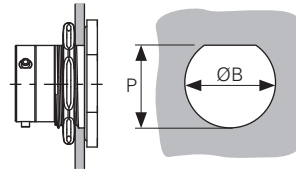

Jam nut receptacle

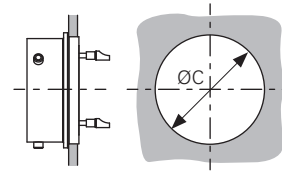

Solder fixing receptacle

Shell size	Ø A ^{±0.003 (±0.1)}	Ø B ^{±0.003 (±0.1*)}	Ø C ^{±0.003 (±0.1*)}	E ^{±0.005 (±0.15)}	F ^{±0.005 (±0.15)}	N		P ^{±0.003 (±0.1*)}	X min
						min	max		
8	0.612 (15.55)	0.574 (14.60)	0.578 (14.70)	0.594 (15.10)	0.124 (3.15)	0.061 (1.57)	0.124 (3.17)	0.541 (13.75)	0.114 (2.90)
10	0.740 (18.80)	0.698 (17.75)	0.688 (17.50)	0.718 (18.26)	0.124 (3.15)	0.061 (1.57)	0.124 (3.17)	0.667 (16.95)	0.114 (2.90)
12	0.872 (22.15)	0.885 (22.50)	0.795 (20.20)	0.811 (20.62)	0.124 (3.15)	0.061 (1.57)	0.124 (3.17)	0.846 (21.50)	0.114 (2.90)
14	0.996 (25.30)	1.011 (25.70)	0.921 (23.40)	0.905 (23.00)	0.124 (3.15)	0.061 (1.57)	0.124 (3.17)	0.952 (24.20)	0.114 (2.90)
16	1.120 (28.45)	1.135 (28.85)	1.047 (26.60)	0.968 (24.60)	0.124 (3.15)	0.061 (1.57)	0.124 (3.17)	1.076 (27.35)	0.114 (2.90)
18	1.246 (31.65)	1.261 (32.05)	1.173 (29.80)	1.061 (26.97)	0.124 (3.15)	0.061 (1.57)	0.124 (3.17)	1.202 (30.55)	0.114 (2.90)
20	1.370 (34.80)	1.385 (35.20)	1.263 (32.10)	1.156 (29.36)	0.124 (3.15)	0.061 (1.57)	0.250 (6.35)	1.326 (33.70)	0.216 (5.50)
22	1.496 (38.00)	1.511 (38.40)	1.389 (35.30)	1.250 (31.75)	0.124 (3.15)	0.061 (1.57)	0.250 (6.35)	1.452 (36.90)	0.216 (5.50)
24	1.622 (41.20)	1.635 (41.55)	1.511 (38.40)	1.374 (34.92)	0.150 (3.82)	0.061 (1.57)	0.250 (6.35)	1.576 (40.05)	0.216 (5.50)

Dimensions are in inches (millimeters)

Souriau 851 series

Specific connectors

Push-pull locking plug

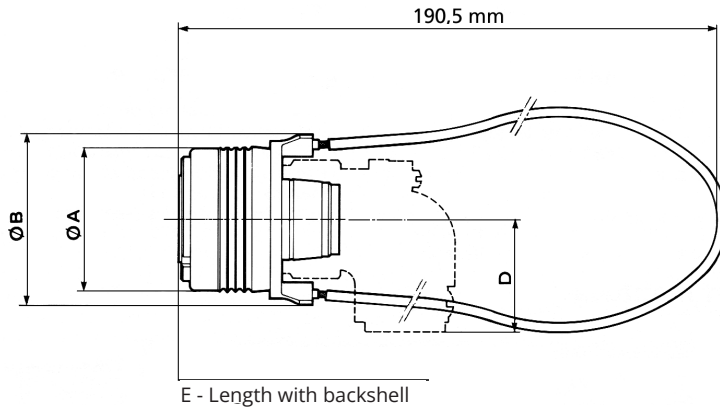

Key characteristics

- Locking: push coupling nut
- Unlocking: pull the lanyard
- Mounted: 851 receptacles
- Layouts and crimp solder contacts
- Black nylon cord, 106 mm

Backshell type	Dimension	Shell size 8	10	12	14	16	18	20	22	24
All	Ø A	0.767 (19.50)	0.897 (22.80)	1.074 (27.30)	1.212 (30.80)	1.338 (34.00)	1.456 (37.00)	1.614 (41.00)	1.752 (44.50)	1.937 (49.20)
All	Ø B	0.982 (24.95)	1.112 (28.25)	1.281 (32.55)	1.419 (36.05)	1.537 (39.05)	1.655 (42.05)	1.803 (45.80)	1.937 (49.20)	2.104 (53.45)
06 R	E	1.259 (32.00)	1.259 (32.00)	1.259 (32.00)	1.259 (32.00)	1.259 (32.00)	1.259 (32.00)	1.251 (31.80)	1.251 (31.80)	1.251 (31.80)
06 RC	E	1.862 (47.30)	1.862 (47.30)	1.862 (47.30)	1.862 (47.30)	1.988 (50.50)	1.988 (50.50)	1.964 (49.90)	1.964 (49.90)	1.964 (49.90)
06 RP	E	1.657 (42.10)	1.657 (42.10)	1.657 (42.10)	1.657 (42.10)	1.657 (42.10)	1.787 (45.40)	1.960 (49.80)	1.960 (49.80)	1.960 (49.80)
06 RA	E	1.614 (41.00)	1.614 (41.00)	1.614 (41.00)	1.614 (41.00)	1.614 (41.00)	1.614 (41.00)	1.693 (43.00)	1.693 (43.00)	1.700 (43.20)
06 RM	E	1.968 (50.00)	1.968 (50.00)	1.968 (50.00)	1.968 (50.00)	1.968 (50.00)	1.968 (50.00)	2.035 (51.70)	2.035 (51.70)	2.035 (51.70)
06 RT specifications 38 or 42	E	1.968 (50.00)	1.968 (50.00)	1.968 (50.00)	1.968 (50.00)	1.968 (50.00)	1.968 (50.00)	2.035 (51.70)	2.035 (51.70)	2.035 (51.70)
08RC	E	1.972 (50.10)	2.070 (52.60)	2.161 (54.90)	2.303 (58.50)	2.393 (60.80)	2.559 (65.00)	2.708 (71.20)	2.803 (71.20)	3.000 (76.20)
	D max	0.629 (16.00)	0.708 (18.00)	0.767 (19.50)	0.866 (22.00)	0.925 (23.50)	0.984 (25.00)	1.043 (26.50)	1.102 (28.00)	1.220 (31.00)

Note: For backshells dimensions, see previous pages

Dimensions are in inches (millimeters)

Ordering information

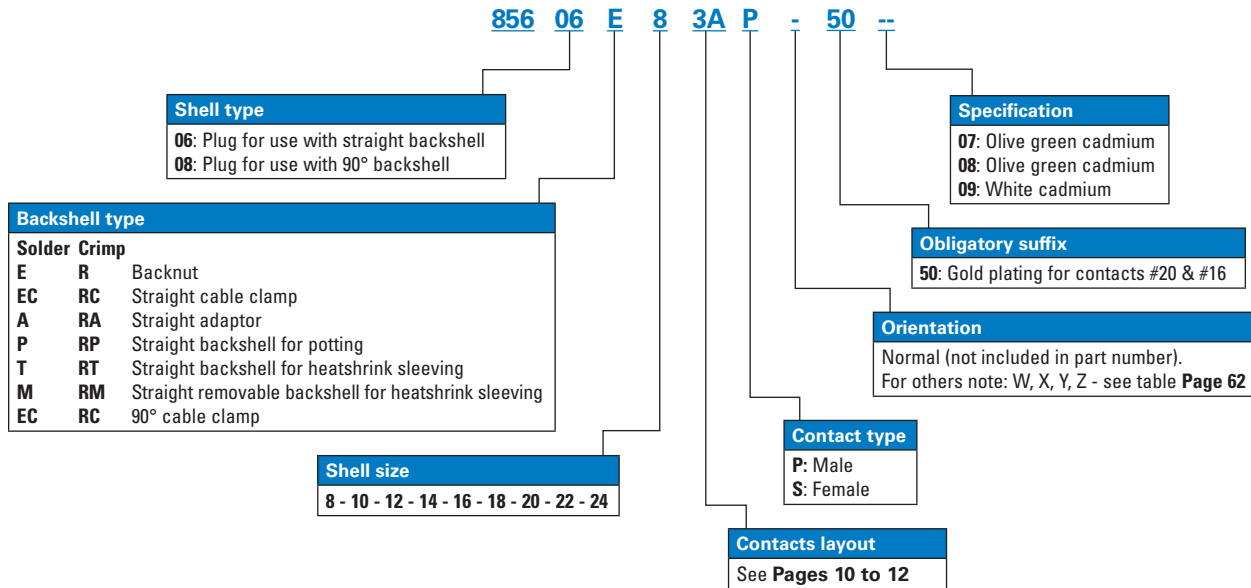

Souriau 851 series

Crimp contacts

Standard version

Contact size	Specification	Wire size		mm ²	Part number		Ø insulator	
		AWG	Inch ²		Male	Female	min	max
#20 Ø1.0 mm	For layouts 8-2, 8-3, 8-4 & 12-14	24-18	0.008-0.036	0.21-0.93	8500-9573*	8500-9213 900*	0.047 (1.20)	0.083 (2.11)
	For further contact layout	24-18	0.008-0.036	0.21-0.93	8500-697	8500-1758A 900	0.047 (1.20)	0.083 (2.11)
	Reducing sleeve	30-24	0.002-0.008	0.06-0.21	8500-781 B1		-	-
#16 Ø1.6 mm	-	18-14	0.036-0.075	0.93-1.91	8500-1300	8500-9331 900	0.062 (1.60)	0.110 (2.80)
	Reducing sleeve	20	0.023	0.60	8500-1985 B1		-	-

Note: * Not to be used with reducing sleeve

Thermocouple version

Contact size	Specification	Wire size		mm ²	Part number		Ø insulator	
		AWG	Inch ²		Male	Female	min	max
#20 Ø1.0 mm	Chromel	24-18	0.008-0.036	0.21-0.93	8500-809 A	8500-2054 900	0.047 (1.20)	0.083 (2.11)
	Alumel	24-18	0.008-0.036	0.21-0.93	8500-812 A	8500-2055 900	0.047 (1.20)	0.083 (2.11)
#16 Ø1.6 mm	Chromel	18-14	0.036-0.075	0.93-1.91	8500-1053	8500-1054 900	0.062 (1.60)	0.110 (2.80)
	Alumel	18-14	0.036-0.075	0.93-1.91	8500-1058	8500-1059 900	0.062	0.110

Dimensions are in inches (millimeters)

Ordering information

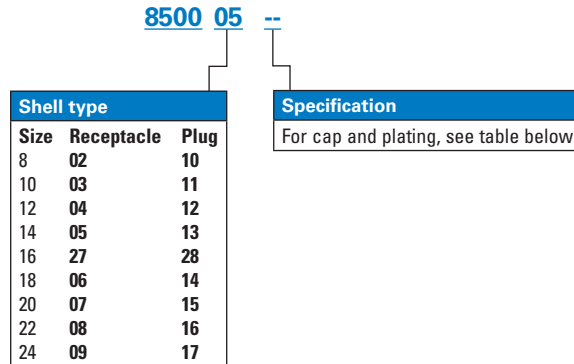

Cap type and plating

Cap type	Receptacle cap				Plug cap			
	Olive green Cadmium	White cadmium	Black anodized	Nickel	olive green cadmium	White cadmium	Black anodized	Nickel
Cap with chain and ring	D	02 D	29 D	44 D	D	02 D	29 D	44 D
Cap with nylon cord and ring	B	02 B	29 B	44 B	B	02 B	29 B	44 B
Cap with nylon cord and washer (shell 10, 12, 14, 16 and 18)	–	–	–	–	E	–	–	–
Cap with nylon cord and washer	H	–	–	44 H	–	–	–	–
Cap with chain and washer	J	–	–	–	–	–	–	–
Cap 500hr salt spray	JQ7	–	–	–	–	–	–	–
Cap without chain	M	–	–	–	M	–	–	–

Souriau 851 series

Caps

Caps for plugs

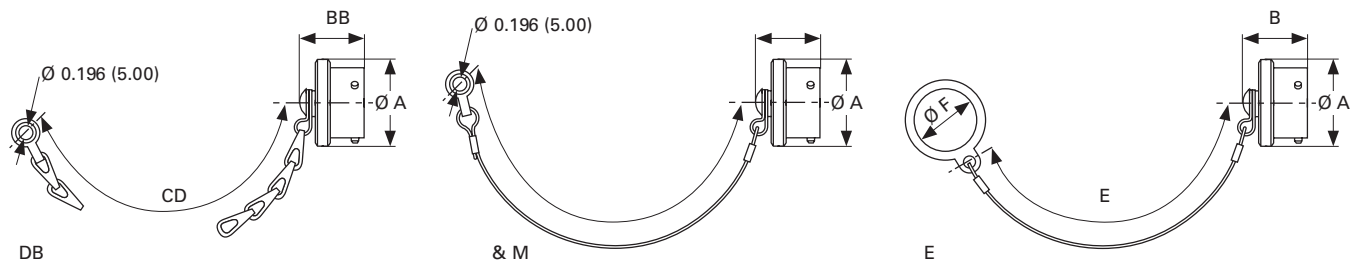

Shell size	Ø A max	B max	C	D ₀ ^{+0.236 (+6)}	E ₀ ^{+0.078 (+2)}	Ø F
8	0.661 (16.80)	0.781 (19.84)	5.196 (132)	5.039 (128)	refer to Eaton	refer to Eaton
10	0.779 (19.80)	0.781 (19.84)	5.196 (132)	5.039 (128)	5.196 (132)	0.551 (14.00)
12	0.940 (23.90)	0.781 (19.84)	5.826 (148)	5.511 (140)	5.826 (148)	0.693 (17.60)
14	1.063 (27.00)	0.781 (19.84)	5.826 (148)	5.511 (140)	5.826 (148)	0.819 (20.80)
16	1.189 (30.20)	0.781 (19.84)	5.826 (148)	5.511 (140)	5.826 (148)	1.007 (25.60)
18	1.315 (33.40)	0.781 (19.84)	5.826 (148)	5.511 (140)	5.826 (148)	1.129 (28.70)
20	1.437 (36.50)	0.844 (21.44)	6.614 (168)	6.023 (153)	refer to Eaton	refer to Eaton
22	1.566 (39.80)	0.844 (21.44)	6.614 (168)	6.023 (153)	refer to Eaton	refer to Eaton
24	1.688 (42.90)	0.874 (22.22)	6.614 (168)	6.023 (153)	refer to Eaton	refer to Eaton

Dimensions are in inches (millimeters)

Caps for receptacles

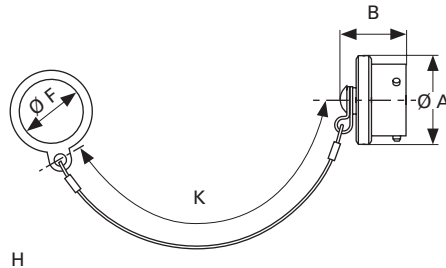
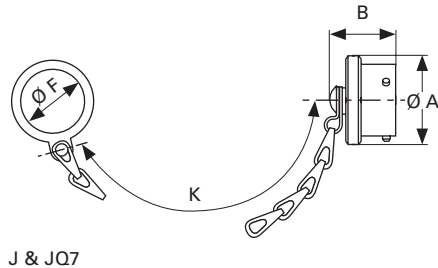
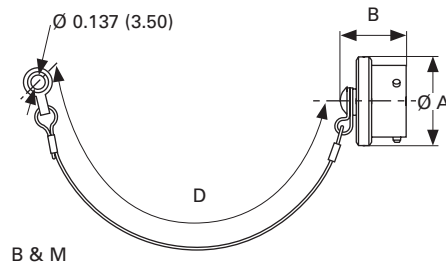
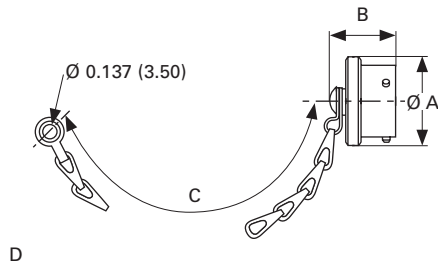

Shell size	Ø A max	B max	C ₀ ^{+0.078 (+2)}	D	J max	H ₀ ^{+0.078 (+2)}	K ₀ ^{+0.236 (+6)}
8	0.748 (19.00)	0.844 (21.44)	3.307 (84)	3.031 (77)	0.582 (14.80)	3.149 (80)	3.307 (84)
10	0.858 (21.80)	0.844 (21.44)	3.307 (84)	3.031 (77)	0.704 (17.90)	3.149 (80)	3.307 (84)
12	1.027 (26.10)	0.844 (21.44)	3.937 (100)	3.503 (89)	0.884 (22.70)	3.543 (90)	3.937 (100)
14	1.153 (29.30)	0.844 (21.44)	3.937 (100)	3.503 (89)	1.019 (25.90)	3.543 (90)	3.937 (100)
16	1.279 (32.50)	0.844 (21.44)	3.937 (100)	3.503 (89)	1.141 (29.00)	3.543 (90)	3.937 (100)
18	1.389 (35.30)	0.844 (21.44)	3.937 (100)	3.503 (89)	1.267 (32.20)	3.543 (90)	3.937 (100)
20	1.527 (38.80)	0.844 (21.44)	4.566 (116)	4.015 (102)	1.394 (35.40)	4.330 (110)	4.566 (116)
22	1.653 (42.00)	0.844 (21.44)	4.566 (116)	4.015 (102)	1.519 (38.60)	4.330 (110)	4.566 (116)
24	1.775 (45.10)	0.874 (22.22)	4.566 (116)	4.015 (102)	1.641 (41.70)	4.330 (110)	4.566 (116)

Plastic protective caps for receptacles and plugs





Shell size	Caps for receptacles	Caps for plugs
8	8500-5585 A	8500-5594
10	8500-5586 A	8500-5595
12	8500-5587 A	8500-5596
14	8500-5588 A	8500-5597
16	8500-5589 A	8500-5598
18	8500-5590 A	8500-5599
20	8500-5591 A	8500-5600
22	8500-5592 A	8500-5601
24	8500-5593 A	8500-5602

Dimensions are in inches (millimeters)

Souriau 851 series

Accessories

Filler plugs

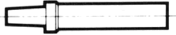
Contact size #20 Ø1 mm	Color	#16 Ø1.6 mm	Color
8500-4144 A (MS 3187 A 20)	Red	8500-479	Blue
			
		8500-4267 (MS 3187-16)	Blue
			

Dummy receptacles

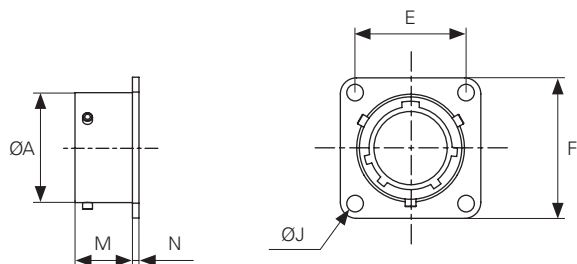

Shell size	Part numbers	Ø A	C max	E	J	M max	N max
8	8500-18	0.473 (12.03)	0.826 (20.99)	0.594 (15.09)	0.123 (3.13)	0.451 (11.70)	0.051 (1.32)
10	8500-19	0.590 (15.01)	0.952 (24.19)	0.718 (18.26)	0.123 (3.13)	0.451 (11.70)	0.051 (1.32)
12	8500-20	0.750 (19.07)	1.044 (26.54)	0.811 (20.62)	0.123 (3.13)	0.451 (11.70)	0.051 (1.32)
14	8500-21	0.876 (22.25)	1.137 (28.89)	0.905 (23.00)	0.123 (3.13)	0.451 (11.70)	0.051 (1.32)
16	8500-26	1.000 (25.42)	1.231 (31.29)	0.968 (24.61)	0.123 (3.13)	0.451 (11.70)	0.051 (1.32)
18	8500-22	1.126 (28.60)	1.326 (33.69)	1.061 (26.97)	0.123 (3.13)	0.451 (11.70)	0.051 (1.32)
20	8500-23	1.250 (31.77)	1.452 (36.89)	1.156 (29.36)	0.123 (3.13)	0.565 (14.35)	0.084 (2.15)
22	8500-24	1.376 (34.95)	1.574 (39.99)	1.250 (31.75)	0.123 (3.13)	0.565 (14.35)	0.084 (2.15)
24	8500-25	1.500 (38.12)	1.698 (43.15)	1.374 (34.92)	0.150 (3.81)	0.598 (15.20)	0.084 (2.15)

Gaskets

Shell size	Gaskets for square flange receptacle neoprene		Gaskets for jam nut receptacle neoprene	
		Fairprene ^(R)		Viton ^(TM)
8	8500-275	8500-4164	3330102	3330675
10	8500-276	8500-4165	3330103	3330670
12	8500-277	8500-4166	3330104	3330671
14	8500-278	8500-4167	3330105	3330672
16	8500-283	8500-4168	3330106	3331048
18	8500-279	8500-4169	3330107	3331049
20	8500-280	8500-4170	3330108	3331050
22	8500-281	8500-4171	3330109	3331051
24	8500-282	8500-4172	3330110	3331052

Dimensions are in inches (millimeters)

Crimping tools

Crimp tooling
Contact #20 & 16



8365
(M 22520/1-01)

Locator contact #20 & 16



8365-02
(M 22520/1-02)

Crimp tooling Contact #20



8476-01
(M 22520/2-01)

Locator Contact #20



8476-02
(M 22520/2-02)

Insertion tools

Crimp contact



8500-29B*

Extraction tools

Crimp contact #20



8500-36A

Insertion tools

Crimp contact #16



8500-38A

Strap backshell



Note: * Except 8-2, 8-3, 8-4, 12-14 contact layouts, use insertion tool 8500-93B

Souriau 851 series

Stripping and crimping instructions

Stripping instructions

Use a well-maintained stripping plier that is suitable for the wire size to be stripped.

To maintain the connector's excellent sealing characteristics and, at the same time, meet the highest cabling standards the wires should have the following external sheath dimensions:

Contacts size	Ø over sheath	
	min	max
20	1.20	2.11
16	1.60	2.80

Recommended loading:

- 50% with maximum diameter wires
- 50% with minimum diameter wires
- 100% with medium size wires

Size 20 contacts for cables:

- When Ø over insulation ≤ 2 mm strip to a 4.5 mm length
- When Ø over insulation > 2 mm strip to a 7 mm length

Size 16 contacts, strip the cable to a length of 6 mm

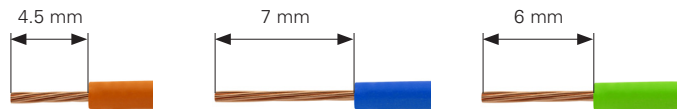

Cable-contact assembly

Push the wire into the crimp barrel and verify that it has gone in properly by looking at the side hole in the barrel.



Reducing sleeve

If a wire with a cross-section area of less than 0.21 mm² is used with a size 20 contact, it will be necessary to use a reducing sleeve: ref. 8500-781.

Wires with cross-section area of 0.6 mm² may be used with size 16 contacts by using a reducing sleeve, ref. 8500-1985.

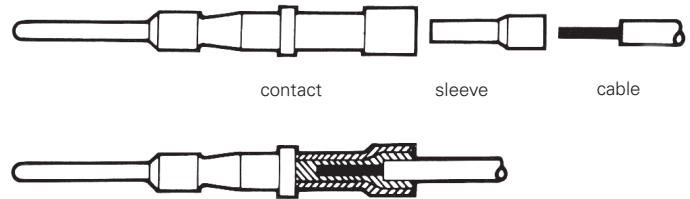

Crimping instructions

With crimping pliers MS 22520/1-01 Souriau part number 8365 and turret MS 22520/1-02 8365-02:



- «red» position for size 20 contacts
- «blue» position for size 16 contacts.



Crimping pliers MS 22520/2-01, Souriau part number 8476-01 and locator MS 22520/2-02 8476-02: Size 20 contacts only.

Note: Not to be used with reducing sleeve.

Squeeze pliers until you hear a distinct click. The pliers should spring open when the ratchet mechanism is released.

- Hold indenter side up; insert the wire, contact assembly or wire-reducing sleeve contact assembly between the four indenters, ensuring that the contact bottoms in the locator.
- Fully close the jaws, once the contact is crimped the pliers must spring open, remove wire and crimped contact, check crimp aspect.



Crimp contact insertion

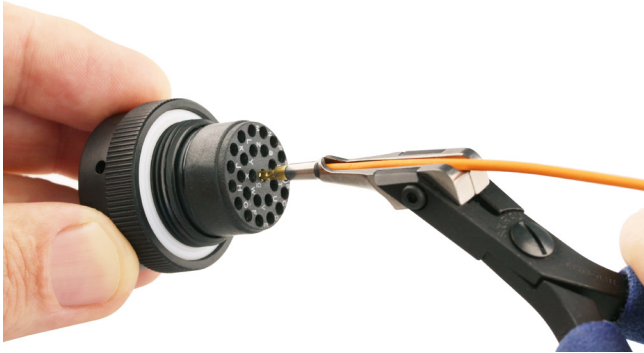

Disassemble and slide connector rear accessory over cables.

Insertion tools:

- Pliers 8500-29B
- Except 8-2, 8-3, 8-4, 12-14 contact layouts: tool 8500-93B

Use of insertion tools:

- Manually insert the contact into the desired insert cavity.
- Insert the wire between the plier jaws, the tip of the jaws butting the contact shoulder.
- Introduce contacts one by one in insert cavities pushing straight in until the contact snaps into position and the clip ensures contact retention.

Filler plugs

Where certain contacts are unwired and where it is necessary to fully maintain the connector's sealing characteristics, a filler plug must be used.

Note: That the contact must be inserted before the filler plug.

Crimp contact extraction



All contacts for use in insulators with clips are extracted using a semi-automatic tool:

- size 20 contacts: tool type 8500-36A
- size 16 contacts: tool type 8500-38A

Disassemble and slide connector rear accessory over cables.

- Do not operate the tool slide button.
- Bring the tool tip over the male or female contact to be removed from connector front (mating face) as far as the first mark for male contacts and the second mark for female contacts.

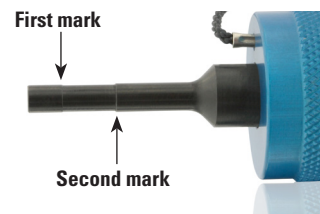

- This operation should be conducted delicately in a direction parallel to the contact center line with a light turning action.
- Extract contact by pushing the slide button fully forward, carefully remove tool and pull wire to release the wire-contact assembly.

Note: Tools have an adjustable spring system (rear knurled knob) for automatic contact disengagement.

Souriau 851 series

Drilling pattern - male rear face

Shell Size Dimension in mm

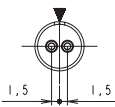
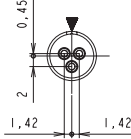
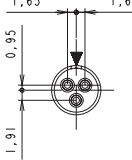
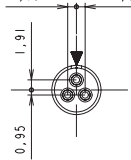
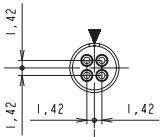
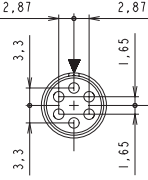
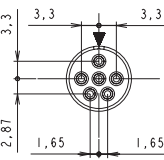
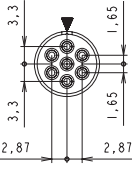
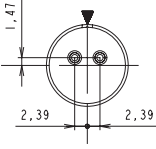
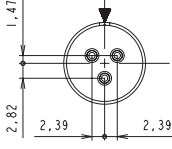
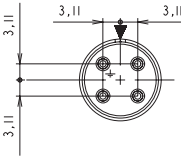
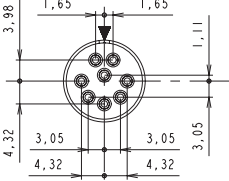
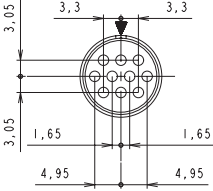
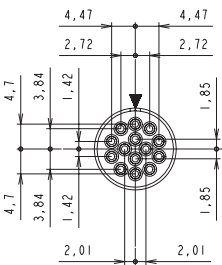
Shell Size	Dimension in mm	Dimension in mm	Dimension in mm	Dimension in mm
8				
	8-2 2 contacts 2 x Ø1.0 (#20)	8-3 3 contacts 3 x Ø1.0 (#20)	8-3A/8-98 3 contacts 3 x Ø1.0 (#20)	8-33 3 contacts 3 x Ø1.0 (#20)
				
	8-4 4 contacts 4 x Ø1.0 (#20)			
10				
	10-6 6 contacts 6 x Ø1.0 (#20)	10-98 6 contacts 6 x Ø1.0 (#20)	10-7 7 contacts 7 x Ø1.0 (#20)	
12				
	12-2 2 contacts 2 x Ø1.6 (#16)	12-3 3 contacts 3 x Ø1.6 (#16)	12-4 3 contacts + ground 4 x Ø1.6 (#16)	12-8 8 contacts 8 x Ø1.0 (#20)
				
	12-10 10 contacts 10 x Ø1.0 (#20)	12-14 14 contacts 14 x Ø1.0 (#20)		

Shell Size Dimension in mm

14

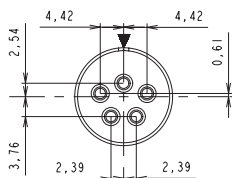

14-5
5 contacts
5 x Ø1.6 (#16)

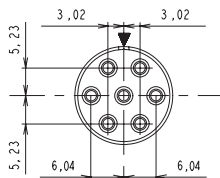

14-7
6 contacts + ground
7 x Ø1.6 (#16)

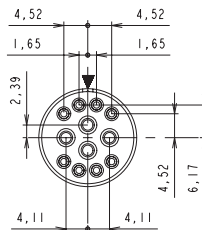

14-12
12 contacts
8 x Ø1.0 (#20) + 4 x Ø1.6 (#16)

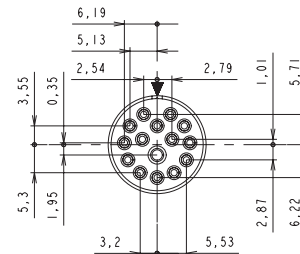

14-15
15 contacts
14 x Ø1.0 (#20) + 1 x Ø1.6 (#16)

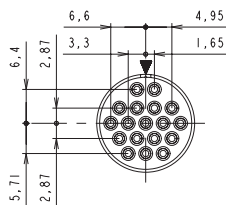

14-18
18 contacts
18 x Ø1.0 (#20)

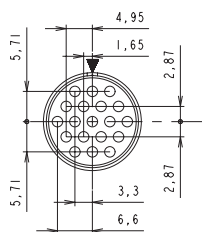

14-19
19 contacts
19 x Ø1.0 (#20)

16

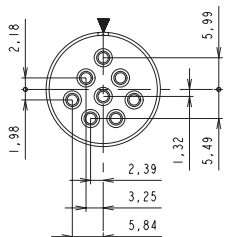

16-8
8 contacts
8 x Ø1.6 (#16)

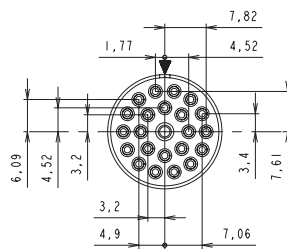

16-23
23 contacts
22 x Ø1.0 (#20) + 1 x Ø1.6 (#16)

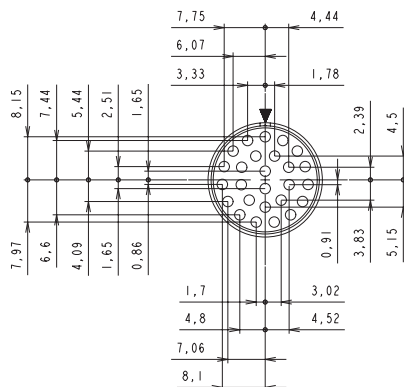

16-26
26 contacts
26 x Ø1.0 (#20)

Souriau 851 series

Drilling pattern - male rear face

Shell Size Dimension in mm

18

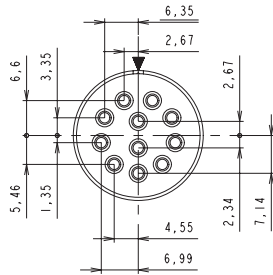

18-11
11 contacts
11xØ1.6 (#16)

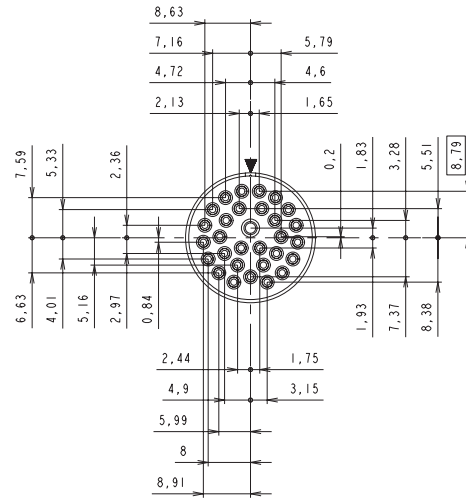

18-30
30 contacts
29xØ1.0 (#20)
1xØ1.6 (#16)

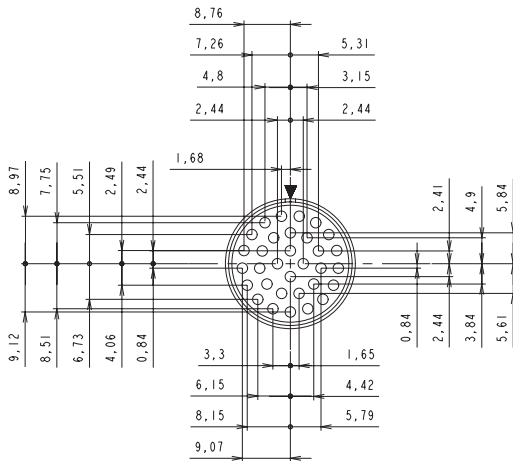

18-32
32 contacts
32xØ1.6 (#16)

20

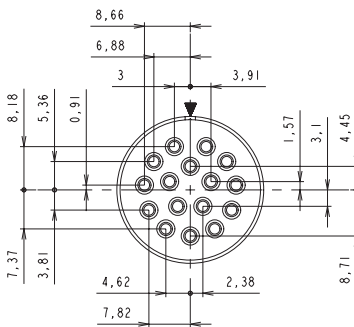

20-16
16 contacts
16xØ1.6 (#16)

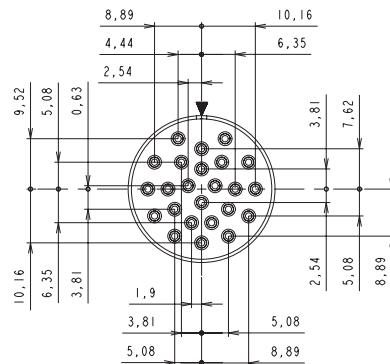

20-24
24 contacts
24xØ1.0 (#20)

Shell Size Dimension in mm

20

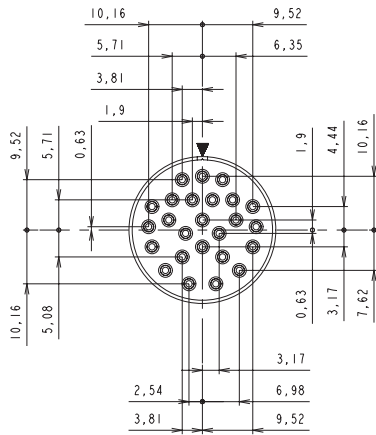

20-25
25 contacts
25 x Ø1.0 (#20)

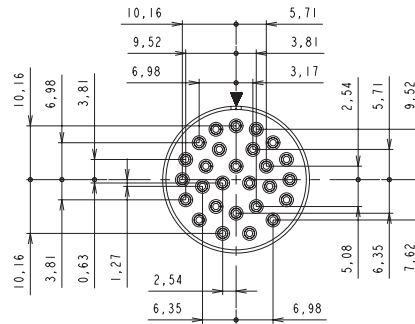

20-27
27 contacts
27 x Ø1.0 (#20)

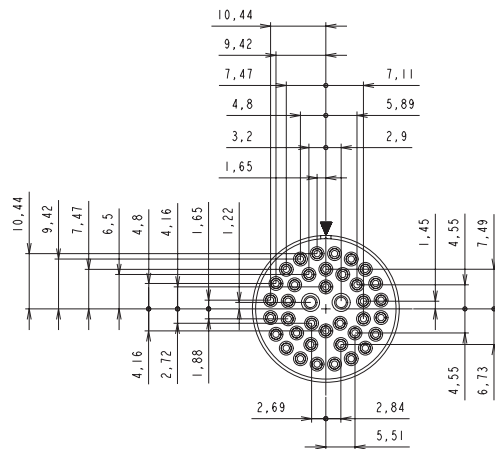

20-39
39 contacts
37 x Ø1.0 (#20) + 2 x Ø1.6 (#16)

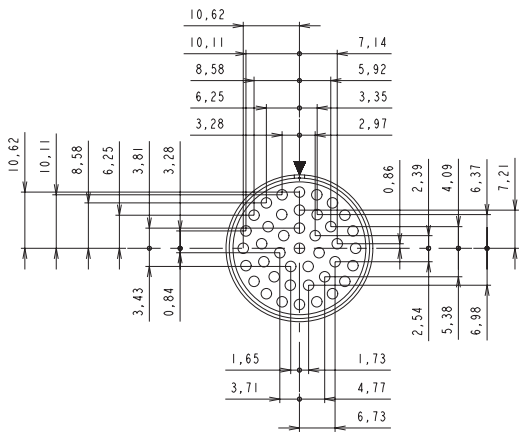

20-41
41 contacts
41 x Ø1.0 (#20)

22

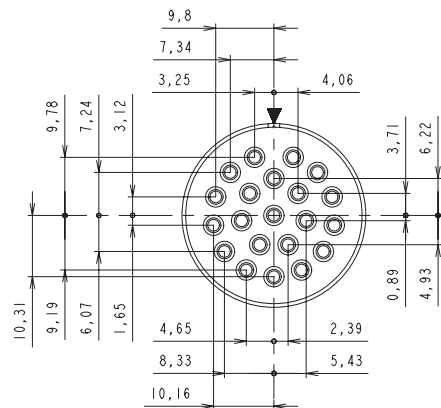

22-21
21 contacts
21 x Ø1.6 (#16)

Souriau 851 series

Drilling pattern - male rear face

Shell Size Dimension in mm

22

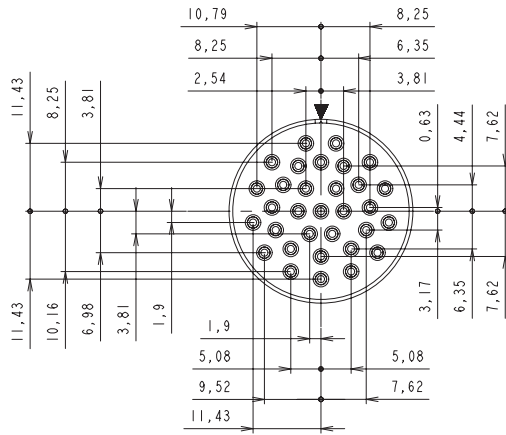

22-32
32 contacts
32 x Ø1.0 (#20)

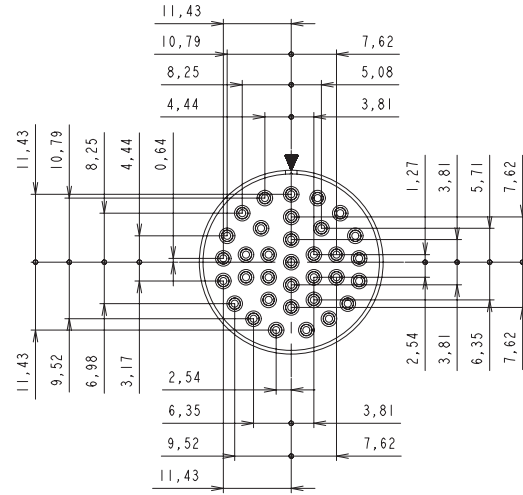

22-34
34 contacts
34 x Ø1.0 (#20)

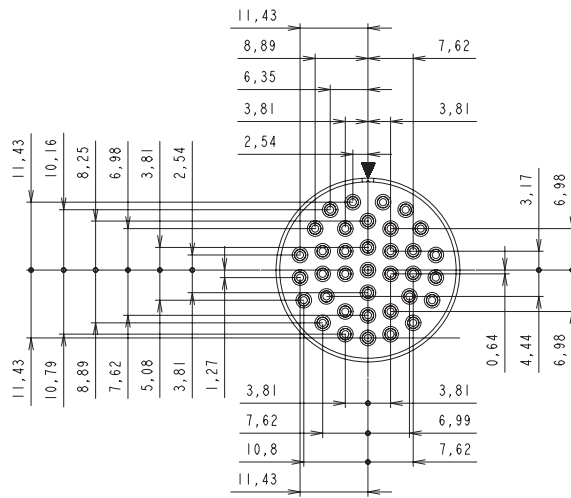

22-36
36 contacts
36 x Ø1.0 (#20)

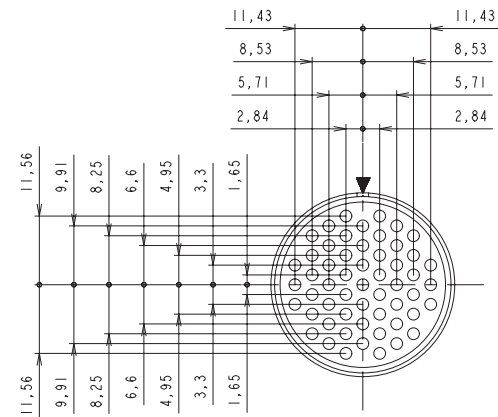

22-55
55 contacts
55 x Ø1.0 (#20)

Shell Size Dimension in mm

24

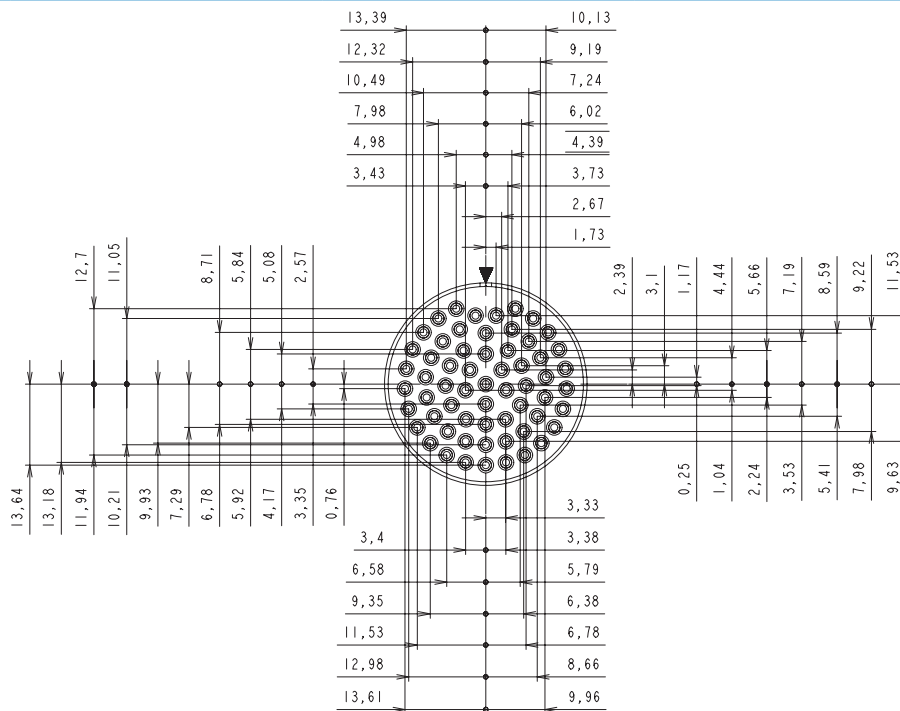

24-61
61 contacts
61 x Ø1.0 (#20)

Souriau 851 series

Discrimination/keying methods

An insulator is rotated within the metal body, as viewed from the front face of a male insulator (receptacle or plug).

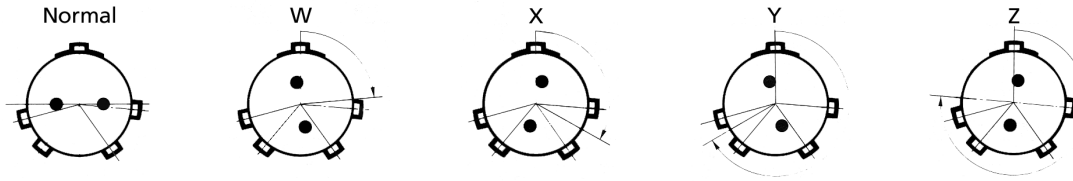

Shells	Layouts	Angle in degrees				NFC 93422 HE 301B		MIL-DTL-26482 G Series I		Service 1 1500 Vrms	Service 2 2300 Vrms
		W	X	Y	Z	Solder	Crimp	Solder	Crimp		
8	2	58	122	–	–			•		X	
	3	60	210	–	–			•		X	
	3A (98)*	60	210	–	–			•	•	X	
	4	45	–	–	–			•		X	
	33	90	–	–	–		•	•	•	X	
10	6	90	–	–	–	•	•	•	•	X	
	7*	90	–	–	–					X	
	98	90	180	240	270			•	•	X	
12	3	–	–	180	–	•	•	•	•		X
	4										
	8	90	112	203	292			•	•	X	
	10	60	155	270	295	•	•	•	•	X	
	2	–	–	–	–						X
	14*	45						•		X	
14	5	40	92	184	273	•	•	•	•		X
	7										
	12	43	90	–	–	•	•	•	•	X	
	15	17	110	155	234	•	•	•	•	X	
	18	15	90	180	270			•	•	X	
	19	30	165	315	–	•	•	•	•	X	
16	8	54	152	180	331	•	•	•	•		X
	23	158	270	–	–	•	•	•	•	X	
	26	60	–	275	338	•	•	•	•	X	
18	11	62	119	241	340	•	•	•	•		X
	32	85	138	222	265	•	•	•	•	X	
	30	180	193	285	350			•	•	X	
20	16	238	318	333	347	•	•	•	•		X
	39	63	144	252	333	•	•	•	•	X	
	41	45	126	225	–	•	•	•	•	X	
	24	70	145	215	290			•	•	X	
	25	72	144	216	288					X	
	27	72	144	216	288		•		•	X	
22	21	16	135	175	349	•	•	•	•		X
	36	72	144	216	288		•			X	
	55	30	142	226	314	•	•	•	•	X	
	32	72	145	215	288				•	X	
	34	62	142	218	298				•	X	
24	61	90	180	270	324	•	•	•	•	X	

Note: * 8-98 layout, W and X non-standard orientations, 10-7 & 12-14 layouts, W non-standard orientation

For more information, contact us:
[Eaton.com/interconnect-support](https://www.eaton.com/interconnect-support)



For more information, contact us:
[eaton.com/interconnect-support](https://www.eaton.com/interconnect-support)

© 2024 Eaton
All Rights Reserved
Document No. TF700-32
March 2024

Eaton is a registered trademark.

All other trademarks are property of
their respective owners.