

LPC 2,5/18-ST-5,08 - PCB connector



1110602

<https://www.phoenixcontact.com/in/products/1110602>

Please be informed that the data shown in this PDF document is generated from our online catalog. Please find the complete data in the user documentation. Our general terms of use for downloads are valid.

PCB connector, nominal cross section: 2.5 mm², color: green, nominal current: 16 A, rated voltage (III/2): 320 V, contact surface: Tin, contact connection type: Socket, number of rows: 1, number of positions: 18, product range: LPC 2,5/..-ST, pitch: 5.08 mm, connection method: Lever Push-in connection, conductor/PCB connection direction: 0 °, locking clip: - Locking clip, plug-in system: COMBICON MSTB 2,5, locking: without, mounting: without, type of packaging: packed in cardboard



Your advantages

- Tool-free lever principle enables time-saving connection and release of conductors with/without ferrules
- Clear lever positions provide reliable feedback on opened or closed clamping spaces
- Time-saving push-in connection when lever is closed
- Quick and convenient testing using integrated test option

Commercial data

Item number	1110602
Packing unit	25 pc
Minimum order quantity	50 pc
Note	Made to order (non-returnable)
Sales key	*****
Product key	AACBAA
GTIN	4063151027438
Weight per piece (including packing)	34.032 g
Weight per piece (excluding packing)	34.032 g
Customs tariff number	85366990
Country of origin	PL

LPC 2,5/18-ST-5,08 - PCB connector



1110602

<https://www.phoenixcontact.com/in/products/1110602>

Technical data

Product properties

Product line	COMBICON Connectors M
Product type	PCB connector
Product family	LPC 2,5/..-ST
Number of positions	18
Pitch	5.08 mm
Number of rows	1

Electrical properties

Nominal current I_N	16 A
Nominal voltage U_N	320 V
Degree of pollution	3
Contact resistance	1 m Ω
Rated voltage (III/3)	250 V
Rated surge voltage (III/3)	4 kV
Rated voltage (III/2)	320 V
Rated surge voltage (III/2)	4 kV
Rated voltage (II/2)	630 V
Rated surge voltage (II/2)	4 kV

Connection data

Connection technology

Connector system	COMBICON MSTB 2,5
Nominal cross section	2.5 mm ²
Contact connection type	Socket

Interlock

Locking type	without
Mounting flange	without

Conductor connection

Connection method	Lever Push-in connection
Connection direction of the conductor to plug-in direction	0 °
Conductor/PCB connection direction	0 °
Conductor cross section rigid	0.2 mm ² ... 2.5 mm ²
Conductor cross section flexible	0.2 mm ² ... 2.5 mm ²
Conductor cross section AWG	26 ... 12
Conductor cross section flexible, with ferrule without plastic sleeve	0.25 mm ² ... 2.5 mm ²
Conductor cross section, flexible, with ferrule, with plastic sleeve	0.25 mm ² ... 2.5 mm ²
2 conductors with the same cross section, flexible, with TWIN ferrule with plastic sleeve	0.5 mm ² ... 1 mm ²

LPC 2,5/18-ST-5,08 - PCB connector



1110602

<https://www.phoenixcontact.com/in/products/1110602>

Cylindrical gauge a x b / diameter	2.8 mm x 2.0 mm / 2.4 mm
Stripping length	10 mm

Specifications for ferrules without insulating collar

recommended crimping tool	1212034 CRIMPFOX 6
ferrules without insulating collar, according to DIN 46228-1	Cross section: 0.25 mm ² ; Length: 7 mm
	Cross section: 0.34 mm ² ; Length: 7 mm
	Cross section: 0.5 mm ² ; Length: 8 mm ... 10 mm
	Cross section: 0.75 mm ² ; Length: 8 mm ... 10 mm
	Cross section: 1 mm ² ; Length: 8 mm ... 12 mm
	Cross section: 1.5 mm ² ; Length: 10 mm ... 12 mm
	Cross section: 2.5 mm ² ; Length: 10 mm ... 12 mm

Specifications for ferrules with insulating collar

recommended crimping tool	1212034 CRIMPFOX 6
ferrules with insulating collar, according to DIN 46228-4	Cross section: 0.25 mm ² ; Length: 8 mm ... 10 mm
	Cross section: 0.34 mm ² ; Length: 8 mm ... 10 mm
	Cross section: 0.5 mm ² ; Length: 8 mm ... 10 mm
	Cross section: 0.75 mm ² ; Length: 10 mm ... 12 mm
	Cross section: 1 mm ² ; Length: 10 mm ... 12 mm
	Cross section: 1.5 mm ² ; Length: 10 mm ... 12 mm
	Cross section: 2.5 mm ² ; Length: 12 mm

Material specifications

Material data - contact

Note	WEEE/RoHS-compliant, free of whiskers according to IEC 60068-2-82/JEDEC JESD 201
Contact material	Cu alloy
Surface characteristics	hot-dip tin-plated
Metal surface terminal point (top layer)	Tin (4 - 8 µm Sn)
Metal surface contact area (top layer)	Tin (4 - 8 µm Sn)

Material data - housing

Color (Housing)	green (6021)
Insulating material	PA
Insulating material group	I
CTI according to IEC 60112	600
Flammability rating according to UL 94	V0
Glow wire flammability index GWFI according to EN 60695-2-12	850
Glow wire ignition temperature GWIT according to EN 60695-2-13	775
Temperature for the ball pressure test according to EN 60695-10-2	125 °C

Material data – actuating element

Color (Actuating element)	orange (2003)
---------------------------	---------------

LPC 2,5/18-ST-5,08 - PCB connector

1110602

<https://www.phoenixcontact.com/in/products/1110602>

Insulating material	PA GF
Insulating material group	I
CTI according to IEC 60112	600
Flammability rating according to UL 94	V0

Dimensions

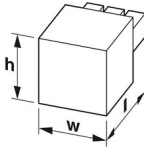
Dimensional drawing	
Pitch	5.08 mm
Width [w]	93.15 mm
Height [h]	15.39 mm
Length [l]	27.73 mm

Notes

Notes on operation	In accordance with IEC 61984, COMBICON connectors have no switching power (COC). During designated use, they must not be plugged in or disconnected when carrying voltage or under load.
--------------------	--

Mechanical tests

Conductor connection

Specification	IEC 60999-1:1999-11
Result	Test passed

Test for conductor damage and slackening

Specification	IEC 60999-1:1999-11
Result	Test passed

Repeated connection and disconnection

Specification	IEC 60999-1:1999-11
Result	Test passed

Pull-out test

Specification	IEC 60999-1:1999-11
Conductor cross section/conductor type/tractive force setpoint/actual value	0.2 mm ² / solid / > 10 N
	0.2 mm ² / flexible / > 10 N
	2.5 mm ² / solid / > 50 N
	2.5 mm ² / flexible / > 50 N

Insertion and withdrawal forces

Result	Test passed
No. of cycles	25
Insertion strength per pos. approx.	7 N

LPC 2,5/18-ST-5,08 - PCB connector



1110602

<https://www.phoenixcontact.com/in/products/1110602>

Withdraw strength per pos. approx.	6 N
Resistance of inscriptions	
Specification	IEC 60068-2-70:1995-12
Result	Test passed
Polarization and coding	
Specification	IEC 60512-13-5:2006-02
Result	Test passed
Visual inspection	
Specification	IEC 60512-1-1:2002-02
Result	Test passed
Dimension check	
Specification	IEC 60512-1-2:2002-02
Result	Test passed

Environmental and real-life conditions

Vibration test

Specification	IEC 60068-2-6:2007-12
Frequency	10 - 150 - 10 Hz
Sweep speed	1 octave/min
Amplitude	0.35 mm (10 Hz ... 60.1 Hz)
Sweep speed	50 m/s ² (60.1 Hz ... 150 Hz)
Test duration per axis	2.5 h

Durability test

Specification	IEC 60512-9-1:2010-03
Impulse withstand voltage at sea level	4.8 kV
Contact resistance R ₁	1 mΩ
Contact resistance R ₂	1.2 mΩ
Insertion/withdrawal cycles	25
Insulation resistance, neighboring positions	> 5 MΩ

Climatic test

Specification	ISO 6988:1985-02
Corrosive stress	0.2 dm ³ SO ₂ on 300 dm ³ /40 °C/1 cycle
Thermal stress	105 °C/168 h
Power-frequency withstand voltage	2.21 kV

Ambient conditions

Ambient temperature (operation)	-40 °C ... 105 °C (dependent on the derating curve)
Ambient temperature (storage/transport)	-40 °C ... 70 °C
Relative humidity (storage/transport)	30 % ... 70 %
Ambient temperature (assembly)	-5 °C ... 100 °C

LPC 2,5/18-ST-5,08 - PCB connector



1110602

<https://www.phoenixcontact.com/in/products/1110602>

Electrical tests

Thermal test | Test group C

Specification	IEC 60512-5-1:2002-02
Tested number of positions	20

Insulation resistance

Specification	IEC 60512-3-1:2002-02
Insulation resistance, neighboring positions	> 5 MΩ

Temperature cycles

Specification	IEC 60999-1:1999-11
Result	Test passed

Air clearances and creepage distances |

Specification	IEC 60664-1:2007-04
Insulating material group	I
Comparative tracking index (IEC 60112)	CTI 600
Rated insulation voltage (III/3)	250 V
Rated surge voltage (III/3)	4 kV
minimum clearance value - non-homogenous field (III/3)	3 mm
minimum creepage distance (III/3)	3.2 mm
Rated insulation voltage (III/2)	320 V
Rated surge voltage (III/2)	4 kV
minimum clearance value - non-homogenous field (III/2)	3 mm
minimum creepage distance (III/2)	3 mm
Rated insulation voltage (II/2)	630 V
Rated surge voltage (II/2)	4 kV
minimum clearance value - non-homogenous field (II/2)	3 mm
minimum creepage distance (II/2)	3.2 mm

Packaging specifications

Type of packaging	packed in cardboard
-------------------	---------------------

LPC 2,5/18-ST-5,08 - PCB connector



1110602

<https://www.phoenixcontact.com/in/products/1110602>

Drawings

Diagram

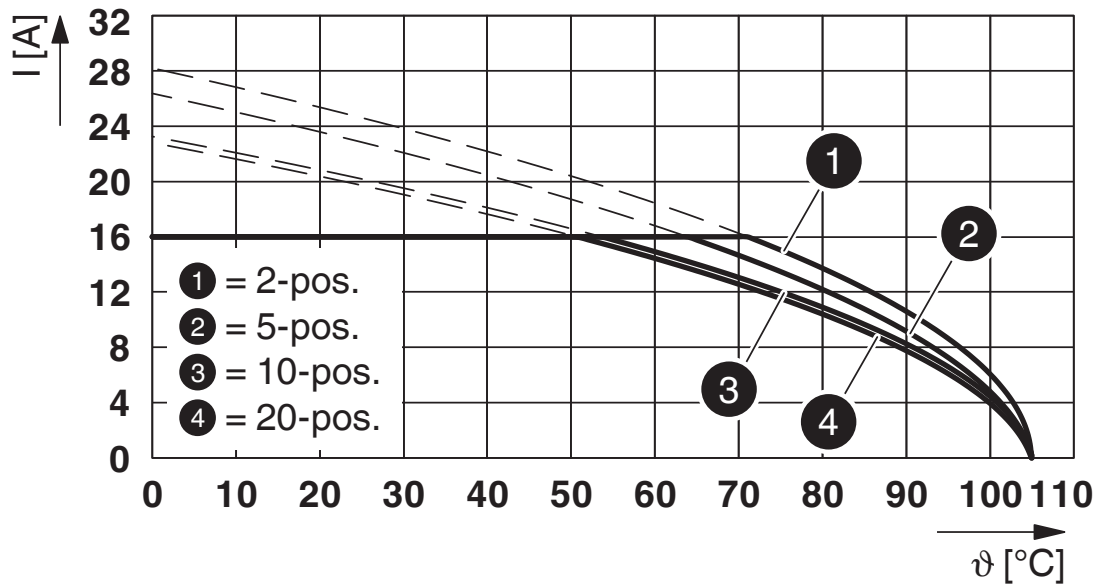

Type: LPC 2,5/...-ST-5,08 with CCA 2,5/...-G-5,08 P...THR

LPC 2,5/18-ST-5,08 - PCB connector





1110602

<https://www.phoenixcontact.com/in/products/1110602>

Approvals

To download certificates, visit the product detail page: <https://www.phoenixcontact.com/in/products/1110602>

 VDE Zeichengenehmigung Approval ID: 40053722				
	Nominal voltage U_N	Nominal current I_N	Cross section AWG	Cross section mm^2
	320 V	16 A	-	0.2 - 2.5

 UL Recognized Approval ID: E60425-20210715				
	Nominal voltage U_N	Nominal current I_N	Cross section AWG	Cross section mm^2
Use group F	320 V	16 A	26 - 12	-

 cULus Recognized Approval ID: E60425-20210715				
	Nominal voltage U_N	Nominal current I_N	Cross section AWG	Cross section mm^2
Use group B	300 V	16 A	26 - 12	-
Use group D	300 V	10 A	26 - 12	-

LPC 2,5/18-ST-5,08 - PCB connector



1110602

<https://www.phoenixcontact.com/in/products/1110602>

Classifications

ECLASS

ECLASS-11.0	27460202
ECLASS-12.0	27460202
ECLASS-13.0	27460202

ETIM

ETIM 8.0	EC002638
----------	----------

UNSPSC

UNSPSC 21.0	39121400
-------------	----------

LPC 2,5/18-ST-5,08 - PCB connector



1110602

<https://www.phoenixcontact.com/in/products/1110602>

Environmental product compliance

China RoHS	Environmentally friendly use period: unlimited = EFUP-e
	No hazardous substances above threshold values

LPC 2,5/18-ST-5,08 - PCB connector

1110602

<https://www.phoenixcontact.com/in/products/1110602>

Accessories

CP-MSTB - Coding profile

1734634

<https://www.phoenixcontact.com/in/products/1734634>

Coding profile, is inserted into the slot on the plug or inverted header, red insulating material



CCA 2,5/18-G-5,08 P26THR - PCB header

1827692

<https://www.phoenixcontact.com/in/products/1827692>

PCB headers, nominal cross section: 2.5 mm², color: black, nominal current: 12 A, rated voltage (III/2): 320 V, contact surface: Tin, contact connection type: Pin, number of potentials: 18, number of rows: 1, number of positions: 18, number of connections: 18, product range: CCA 2,5/...-G, pitch: 5.08 mm, connection method: Plug-in connection, mounting: THR soldering, pin layout: Linear pinning, solder pin [P]: 2.6 mm, number of solder pins per potential: 1, plug-in system: COMBICON MSTB 2,5, Pin connector pattern alignment: Standard, locking: without, mounting: without, type of packaging: packed in cardboard



LPC 2,5/18-ST-5,08 - PCB connector

1110602

<https://www.phoenixcontact.com/in/products/1110602>

CCVA 2,5/18-G-5,08 P26THR - PCB header

1827935

<https://www.phoenixcontact.com/in/products/1827935>



PCB headers, nominal cross section: 2.5 mm², color: black, nominal current: 12 A, rated voltage (III/2): 320 V, contact surface: Tin, contact connection type: Pin, number of potentials: 18, number of rows: 1, number of positions: 18, number of connections: 18, product range: CCVA 2,5/..-G, pitch: 5.08 mm, mounting: THR soldering, pin layout: Linear pinning, solder pin [P]: 2.6 mm, number of solder pins per potential: 1, plug-in system: COMBICON MSTB 2,5, Pin connector pattern alignment: Standard, locking: without, mounting: without, type of packaging: packed in cardboard

MDSTB 2,5/18-G1-5,08 - PCB header

1762525

<https://www.phoenixcontact.com/in/products/1762525>



PCB headers, nominal cross section: 2.5 mm², color: green, nominal current: 10 A, rated voltage (III/2): 320 V, contact surface: Tin, contact connection type: Pin, number of potentials: 36, number of rows: 2, number of positions: 18, number of connections: 36, product range: MDSTB 2,5/..-G1, pitch: 5.08 mm, mounting: Wave soldering, pin layout: Linear pinning, solder pin [P]: 3.5 mm, number of solder pins per potential: 1, plug-in system: COMBICON MSTB 2,5, Pin connector pattern alignment: Standard, locking: without, mounting: without, type of packaging: packed in cardboard, In combination with MVSTB or FKCV plug components, both an MVSTBW (or FKCVW) and an MVSTBR plug (or FKCVR) must be used. Combination with TMSTBP plug components is not possible!

LPC 2,5/18-ST-5,08 - PCB connector

1110602

<https://www.phoenixcontact.com/in/products/1110602>



MSTB 2,5/18-G-5,08 - PCB header

1759172

<https://www.phoenixcontact.com/in/products/1759172>

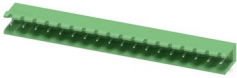

PCB headers, nominal cross section: 2.5 mm², color: green, nominal current: 12 A, rated voltage (III/2): 320 V, contact surface: Tin, contact connection type: Pin, number of potentials: 18, number of rows: 1, number of positions: 18, number of connections: 18, product range: MSTB 2,5/..-G, pitch: 5.08 mm, mounting: Wave soldering, pin layout: Linear pinning, solder pin [P]: 3.5 mm, number of solder pins per potential: 1, plug-in system: COMBICON MSTB 2,5, Pin connector pattern alignment: Standard, locking: without, mounting: without, type of packaging: packed in cardboard

MSTBA 2,5/18-G-5,08 - PCB header

1757404

<https://www.phoenixcontact.com/in/products/1757404>

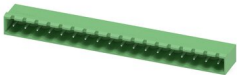

PCB headers, nominal cross section: 2.5 mm², color: green, nominal current: 12 A, rated voltage (III/2): 320 V, contact surface: Tin, contact connection type: Pin, number of potentials: 18, number of rows: 1, number of positions: 18, number of connections: 18, product range: MSTBA 2,5/..-G, pitch: 5.08 mm, mounting: Wave soldering, pin layout: Linear pinning, solder pin [P]: 3.5 mm, number of solder pins per potential: 1, plug-in system: COMBICON MSTB 2,5, Pin connector pattern alignment: Standard, locking: without, mounting: without, type of packaging: packed in cardboard

LPC 2,5/18-ST-5,08 - PCB connector

1110602

<https://www.phoenixcontact.com/in/products/1110602>

MSTBV 2,5/18-G-5,08 - PCB header

1758173

<https://www.phoenixcontact.com/in/products/1758173>

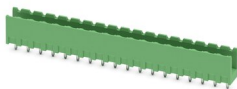

PCB headers, nominal cross section: 2.5 mm², color: green, nominal current: 12 A, rated voltage (III/2): 320 V, contact surface: Tin, contact connection type: Pin, number of potentials: 18, number of rows: 1, number of positions: 18, number of connections: 18, product range: MSTBV 2,5/..-G, pitch: 5.08 mm, mounting: Wave soldering, pin layout: Linear pinning, solder pin [P]: 3.9 mm, number of solder pins per potential: 1, plug-in system: COMBICON MSTB 2,5, Pin connector pattern alignment: Standard, locking: without, mounting: without, type of packaging: packed in cardboard

MSTBVA 2,5/18-G-5,08 - PCB header

1755891

<https://www.phoenixcontact.com/in/products/1755891>

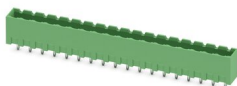

PCB headers, nominal cross section: 2.5 mm², color: green, nominal current: 12 A, rated voltage (III/2): 320 V, contact surface: Tin, contact connection type: Pin, number of potentials: 18, number of rows: 1, number of positions: 18, number of connections: 18, product range: MSTBVA 2,5/..-G, pitch: 5.08 mm, mounting: Wave soldering, pin layout: Linear pinning, solder pin [P]: 3.9 mm, number of solder pins per potential: 1, plug-in system: COMBICON MSTB 2,5, Pin connector pattern alignment: Standard, locking: without, mounting: without, type of packaging: packed in cardboard

LPC 2,5/18-ST-5,08 - PCB connector

1110602

<https://www.phoenixcontact.com/in/products/1110602>



MSTBW 2,5/18-G-5,08 - PCB header

1735727

<https://www.phoenixcontact.com/in/products/1735727>



PCB headers, nominal cross section: 2.5 mm², color: green, nominal current: 12 A, rated voltage (III/2): 320 V, contact surface: Tin, contact connection type: Pin, number of potentials: 18, number of rows: 1, number of positions: 18, number of connections: 18, product range: MSTBW 2,5/..-G, pitch: 5.08 mm, mounting: Wave soldering, pin layout: Linear pinning, solder pin [P]: 3.5 mm, number of solder pins per potential: 1, plug-in system: COMBICON MSTB 2,5, Pin connector pattern alignment: Standard, locking: without, mounting: without, type of packaging: packed in cardboard

SMSTB 2,5/18-G-5,08 - PCB header

1769625

<https://www.phoenixcontact.com/in/products/1769625>



PCB headers, nominal cross section: 2.5 mm², color: green, nominal current: 12 A, rated voltage (III/2): 320 V, contact surface: Tin, contact connection type: Pin, number of potentials: 18, number of rows: 1, number of positions: 18, number of connections: 18, product range: SMSTB 2,5/..-G, pitch: 5.08 mm, mounting: Wave soldering, pin layout: Linear pinning, solder pin [P]: 3.5 mm, number of solder pins per potential: 1, plug-in system: COMBICON MSTB 2,5, Pin connector pattern alignment: Standard, locking: without, mounting: without, type of packaging: packed in cardboard

LPC 2,5/18-ST-5,08 - PCB connector



1110602

<https://www.phoenixcontact.com/in/products/1110602>

SMSTBA 2,5/18-G-5,08 - PCB header

1767533

<https://www.phoenixcontact.com/in/products/1767533>



PCB headers, nominal cross section: 2.5 mm², color: green, nominal current: 12 A, rated voltage (III/2): 320 V, contact surface: Tin, contact connection type: Pin, number of potentials: 18, number of rows: 1, number of positions: 18, number of connections: 18, product range: SMSTBA 2,5/...-G, pitch: 5.08 mm, mounting: Wave soldering, pin layout: Linear pinning, solder pin [P]: 3.5 mm, number of solder pins per potential: 1, plug-in system: COMBICON MSTB 2,5, Pin connector pattern alignment: Standard, locking: without, mounting: without, type of packaging: packed in cardboard

Phoenix Contact 2023 © - all rights reserved

<https://www.phoenixcontact.com>

PHOENIX CONTACT (I) Pvt. Ltd.

A-58/2, Okhla Industrial Area, Phase - II, New Delhi-110 020

+91.1275.71420

info@phoenixcontact.co.in