

## KL73 薄膜チップインダクタ

Thin Film Chip Inductors

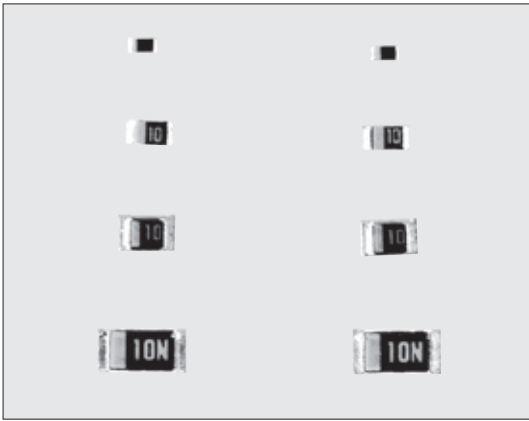

### ■構造図 Construction

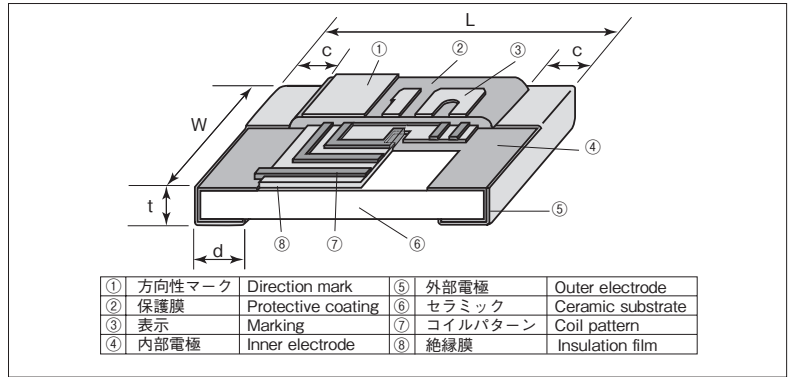

外装色：紺 Coating color : Dark blue

### ■特長 Features

- 独自の薄膜多層化技術により低抵抗、高Qを実現。
- ±2%の狭偏差により回路の無調整が可能。
- 自己共振周波数が高く、高周波特性が優れている。
- 薄型小形形状で高密度実装に対応（1005サイズから3216サイズまで各タイプをラインアップ）。
- 方向性表示あり。（全サイズ）
- 1608サイズ以上では、L値表示があります。
- リフロー、フローはんだ付けに対応します。
- 端子鉛フリー品は、欧州RoHS対応品です。
- AEC-Q200に対応（データ取得）しています。
- KOA original thin-film multi-layer technology realizes low DC resistance and high Q.
- No circuit adjustment is possible due to narrow tolerance ±2%.
- High self resonant frequency and excellent high frequency characteristics.
- Applicable to high density mounting with thin and miniature type (each type of 1005~3216 sizes is lined up).
- Direction marking. (All size)
- Inductance value marking. (1J, 2A, 2B)
- Suitable for both reflow and flow solderings.
- Products with lead free termination meet EU-RoHS requirements.
- AEC-Q200 qualified.

### ■外形寸法 Dimensions

形名 Type (Inch Size Code)	寸法 Dimensions (mm)					Weight (g) (1000pcs)
	L	W	c	d	t	
1E (0402)	1.0±0.1	0.5±0.05	0.15±0.1	0.25±0.1	0.35±0.05	0.68
1J (0603)	1.6±0.2	0.8±0.1	0.3±0.1	0.3±0.1	0.5±0.1	2.14
2A (0805)	2.0±0.2	1.25±0.2	0.4±0.2	0.3±0.2	0.5±0.1	4.54
2B (1206)	3.2±0.2	1.6±0.2	0.5±0.2	0.4 <sup>+0.2</sup> <sub>-0.1</sub>	0.6±0.1	9.14

### ■品名構成 Type Designation

例 Example

KL73	1E	T	TP	10N	G
品 種 Product Code	形 状 Style	端子表面材質 Terminal Surface Material	二次加工 Taping	公称インダクタンス Nominal Inductance	許容差 Tolerance
	1E:1.0×0.5mm 1J:1.6×0.8mm 2A:2.0×1.25mm 2B:3.2×1.6mm	T:Sn	TP:2mm pitch paper TE:4mm pitch plastic embossed BK: Bulk		B:±0.1nH C:±0.2nH G:±2% J:±5%

端子表面材質は鉛フリーめっき品が標準となります。

環境負荷物質含有についてEU-RoHS以外の物質に対するご要求がある場合にはお問合せください。テーピングの詳細については巻末のAPPENDIX Cを参照してください。

The terminal surface material lead free is standard.

Contact us when you have control request for environmental hazardous material other than the substance specified by EU-RoHS.

For further information on taping, please refer to APPENDIX C on the back pages.

### ■用途 Applications

- 移動体通信機器の端末及び基地局の高周波回路
- High frequency circuits in terminal and base station of mobile wireless equipment.

### ■性能 Performance

試験項目 Test Items	規格値 Performance Requirements Maximum ΔL/L		試験方法 Test Methods
	保証値 Limit	代表値 Typical	
はんだ耐熱性 Resistance to soldering heat	ΔL/L:±2%、ΔQ/Q:±20% 外観・構造に著しい異常がないこと。 Without distinct damage in appearance and construction.	ΔL/L:±0.5% ΔQ/Q:±1.5%	260°C±5°C, 10s±1s
温度急変 Rapid change of temperature	ΔL/L:±2%、ΔQ/Q:±20% 外観・構造に著しい異常がないこと。 Without distinct damage in appearance and construction.	ΔL/L:±0.5% ΔQ/Q:±1.6%	-40°C (30min.) / +125°C (30min.) 100 cycles
低温放置 Low temperature exposure	ΔL/L:±2%、ΔQ/Q:±20% 外観・構造に著しい異常がないこと。 Without distinct damage in appearance and construction.	ΔL/L:±0.7% ΔQ/Q:±1.2%	-40°C±3°C, 1000h
高温放置 High temperature exposure	ΔL/L:±2%、ΔQ/Q:±20% 外観・構造に著しい異常がないこと。 Without distinct damage in appearance and construction.	ΔL/L:±0.4% ΔQ/Q:±1.3%	125°C±2°C, 1000h
耐湿性 Moisture endurance	ΔL/L:±2%、ΔQ/Q:±20% 外観・構造に著しい異常がないこと。 Without distinct damage in appearance and construction. 絶縁抵抗:50MΩ以上 Insulation Resistance:50MΩ or more	ΔL/L:±0.4% ΔQ/Q:±1.4%	40°C±2°C, 90%~95%RH, 1000h
耐溶剤性 Resistance to solvent	ΔL/L:±2%、ΔQ/Q:±20% 表示・外観・構造に著しい異常がないこと。 Without distinct damage in appearance, construction and marking.	ΔL/L:±0.6% ΔQ/Q:±1.2%	チップコイルをJIS K8839 (1995) 2-プロパノールの試薬 (温度20°C~25°C) の中に30s±5s秒間、浸せきする。 Immerse the inductors for 30s±5s in the reagent (20°C~25°C) of JIS K8839 (1995)

## ■ 定格 Ratings

使用温度範囲 Operating temperature range : -40°C~+125°C

テーピング記号と包装数/リール Taping code and Q'ty/Reel : 1E : TP (10,000pcs), 1J : TE (4,000pcs)

形名 Type	表示 Marking	公称インダクタンス Nominal Inductance (nH)	インダクタンス許容差 Inductance Tolerance	Q値 Quality Factor Min.	自己共振周波数 Self Resonant Frequency (MHz) Min.	直流抵抗 DC Resistance (Ω) Max.	許容直流電流 Allowable DC Current (mA) Max.	測定周波数 Measuring Frequency (MHz)
KL73 1E TTP N56B	—	0.56	B:±0.1nH	7	14,000	0.10	700	500
KL73 1E TTP N68B	—	0.68						
KL73 1E TTP N82B	—	0.82						
KL73 1E TTP 1N0□	—	1.0	B:±0.1nH C:±0.2nH	10	12,000	0.15		
KL73 1E TTP 1N2□	—	1.2						
KL73 1E TTP 1N5□	—	1.5						
KL73 1E TTP 1N8□	—	1.8						
KL73 1E TTP 2N2□	—	2.2						
KL73 1E TTP 2N7□	—	2.7						
KL73 1E TTP 3N3□	—	3.3						
KL73 1E TTP 3N9□	—	3.9						
KL73 1E TTP 4N7□	—	4.7						
KL73 1E TTP 5N6□	—	5.6						
KL73 1E TTP 6N8□	—	6.8						
KL73 1E TTP 8N2□	—	8.2						
KL73 1E TTP 10N□	—	10						
KL73 1E TTP 12N□	—	12						
KL73 1E TTP 15N□	—	15						
KL73 1E TTP 18N□	—	18						
KL73 1E TTP 22N□	—	22						
KL73 1E TTP 27N□	—	27						
KL73 1E TTP 33N□	—	33						
KL73 1E TTP 33N□	—	33	G:±2% J:±5%	7	1,500	5.00	150	
KL73 1E TTP 33N□	—	33			1,000			
KL73 1J TTE 1N0C	L1	1.0	C:±0.2nH	10	13,000	0.10	650	500
KL73 1J TTE 1N2C	L2	1.2		15				
KL73 1J TTE 1N5C	L3	1.5		20	10,000	0.15	450	
KL73 1J TTE 1N8C	L4	1.8						
KL73 1J TTE 2N2C	22	2.2						
KL73 1J TTE 2N7C	27	2.7						
KL73 1J TTE 3N3C	33	3.3						
KL73 1J TTE 3N9C	39	3.9						
KL73 1J TTE 4N7C	47	4.7						
KL73 1J TTE 5N6□	56	5.6		25	5,000	0.50	350	
KL73 1J TTE 6N8□	68	6.8						
KL73 1J TTE 8N2□	82	8.2						
KL73 1J TTE 10N□	10	10						
KL73 1J TTE 12N□	12	12						
KL73 1J TTE 15N□	15	15						
KL73 1J TTE 18N□	H1	18	10	1,500	1.50	200		
KL73 1J TTE 22N□	H2	22						
KL73 1J TTE 27N□	H3	27						
KL73 1J TTE 33N□	H4	33						
KL73 1J TTE 39N□	H5	39						
KL73 1J TTE 47N□	H6	47						
KL73 1J TTE 56N□	H7	56						
KL73 1J TTE 68N□	H8	68						
KL73 1J TTE 68N□	H8	68	600	2.50	150			
KL73 1J TTE 68N□	H8	68						
KL73 1J TTE 68N□	H8	68						
KL73 1J TTE 68N□	H8	68	600	4.00	100			
KL73 1J TTE 68N□	H8	68						
KL73 1J TTE 68N□	H8	68	600	4.50	100			
KL73 1J TTE 68N□	H8	68						

インダクタ  
Inductor

形名中□にはインダクタンス許容差記号(B、C、G、J)が入ります。 The code for inductance tolerance (B, C, G, J) enters □.

## ■ 使用上の注意 Precautions for Use

- ランドパターンの大きさによりQ値に影響が生じますので、事前の実機にて特性をご確認ください。
- 腐食性ガス（塩素ガス、硫化ガス、酸性ガス等）の雰囲気内では使用しないでください。
- KL73は、インダクタの特性において方向性を持ちます。使用用途、回路によっては、コイルをおく方向により特性が変化します。
- The pattern size of pad may affect Q values, so confirm the characteristics beforehand by actual machines.
- Do not use this product in an atmosphere filled with corrosive gas such as chlorine, sulfide, acid, etc.
- KL73 series are an asymmetric inductor. The characteristics of KL73 series are influenced according to the layout direction of the product in some applications or circuits.

# THIN FILM INDUCTORS

## KL73 薄膜チップインダクタ Thin Film Chip Inductors

### ■定格(続き) Ratings (Continued)

使用温度範囲 Operating temperature range : -40°C~+125°C

テーピング記号と包装数/リール Taping code and Q'ty/Reel : 2A, 2B : TE (4,000pcs)

形名 Type	表示 Marking	公称インダクタンス Nominal Inductance (nH)	インダクタンス許容差 Inductance Tolerance	Q値 Quality Factor Min.	自己共振周波数 Self Resonant Frequency (MHz) Min.	直流抵抗 DC Resistance (Ω) Max.	許容直流電流 Allowable DC Current (mA) Max.	測定周波数 Measuring Frequency (MHz)																			
KL73 2A TTE 1N0C	1.0	1.0	C:±0.2nH	20	13,000	0.25	900	500																			
KL73 2A TTE 1N2C	1.2	1.2			10,000																						
KL73 2A TTE 1N5C	1.5	1.5			9,000																						
KL73 2A TTE 1N8C	1.8	1.8			8,000																						
KL73 2A TTE 2N2C	2.2	2.2			6,000																						
KL73 2A TTE 2N7C	2.7	2.7			5,000																						
KL73 2A TTE 3N3C	3.3	3.3			4,500																						
KL73 2A TTE 3N9C	3.9	3.9		25	4,000	0.50	700																				
KL73 2A TTE 4N7C	4.7	4.7			3,000																						
KL73 2A TTE 5N6□	5.6	5.6			2,500																						
KL73 2A TTE 6N8□	6.8	6.8			2,000																						
KL73 2A TTE 8N2□	8.2	8.2			1,500																						
KL73 2A TTE 10N□	10	10			1,000																						
KL73 2A TTE 12N□	12	12			800																						
KL73 2A TTE 15N□	15	15	15	700	1.00	400																					
KL73 2A TTE 18N□	18	18					20	600	1.50	300																	
KL73 2A TTE 22N□	22	22									10	500	2.00	250													
KL73 2A TTE 27N□	27	27													25	400	2.50	200									
KL73 2A TTE 33N□	33	33																	35	300	3.00	150					
KL73 2A TTE 39N□	39	39																					40	2,500	4.00	100	
KL73 2A TTE 47N□	47	47																									25
KL73 2A TTE 56N□	56	56	15	1,500	1.00	200																					
KL73 2A TTE 68N□	68	68					25	1,000	1.50	150																	
KL73 2A TTE 82N□	82	82									40	500	2.00	100													
KL73 2B TTE 2N2C	2N2	2.2													G:±2% J:±5%	25	9,000	0.25									
KL73 2B TTE 2N7C	2N7	2.7																	35	7,000	0.50	900					
KL73 2B TTE 3N3C	3N3	3.3																					40	6,000	1.00	800	
KL73 2B TTE 3N9C	3N9	3.9																									25
KL73 2B TTE 4N7C	4N7	4.7	15	4,500	2.00	400																					
KL73 2B TTE 5N6□	5N6	5.6					10	4,000	2.50	300																	
KL73 2B TTE 6N8□	6N8	6.8									25	3,500	3.00	200													
KL73 2B TTE 8N2□	8N2	8.2													40	3,000	4.00	150									
KL73 2B TTE 10N□	10N	10																	25	2,500	5.00	100					
KL73 2B TTE 12N□	12N	12																					15	2,000	1.00	500	
KL73 2B TTE 15N□	15N	15																									25
KL73 2B TTE 18N□	18N	18	40	1,000	2.00	300																					
KL73 2B TTE 22N□	22N	22					25	500	2.50	200																	
KL73 2B TTE 27N□	27N	27									15	400	3.00	150													
KL73 2B TTE 33N□	33N	33													40	300	4.00	100									
KL73 2B TTE 39N□	39N	39																	25	200	5.00	50					
KL73 2B TTE 47N□	47N	47																					15	150	6.00	20	
KL73 2B TTE 56N□	56N	56																									40
KL73 2B TTE 68N□	68N	68	25	50	8.00	5																					
KL73 2B TTE 82N□	82N	82					15	20	9.00	2																	
KL73 2B TTE 100□	100	100									40	10	10.00	1													

形名中□にはインダクタンス許容差記号(G, J)が入ります。 The code for inductance tolerance (G, J) enters □.

インダクタ  
Inductor

## ■特性 Characteristics

測定器 Test equipment : HP4291B impedance analyzer (1E, 1J, 2A, 2B)

L-f 特性 L-Frequency Characteristics

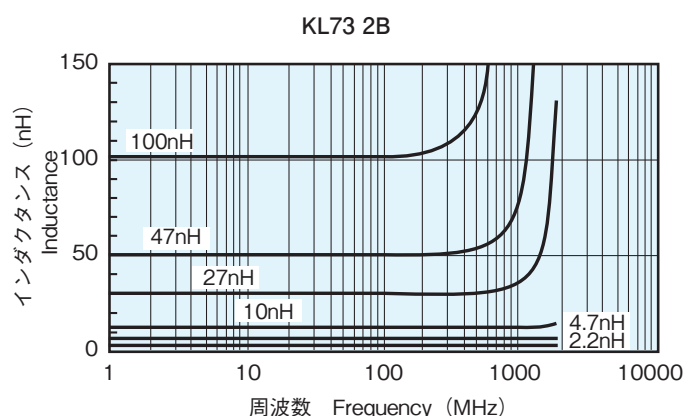
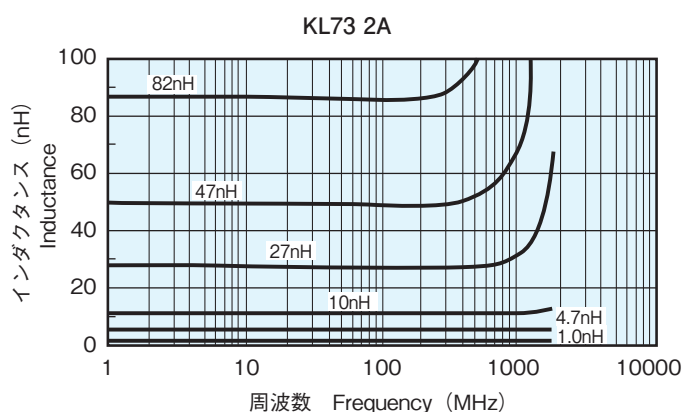
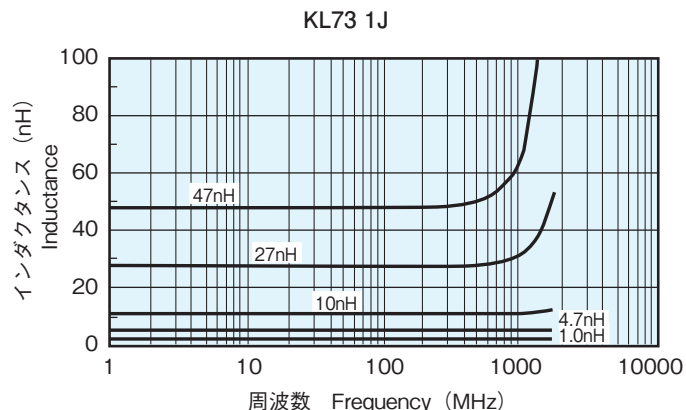
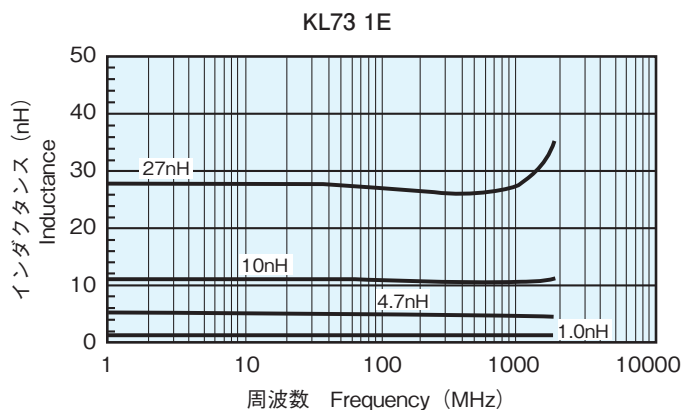

Q-f 特性 Q-Frequency Characteristics

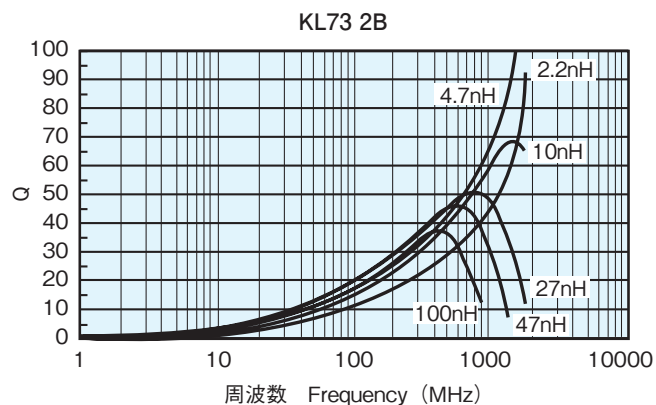
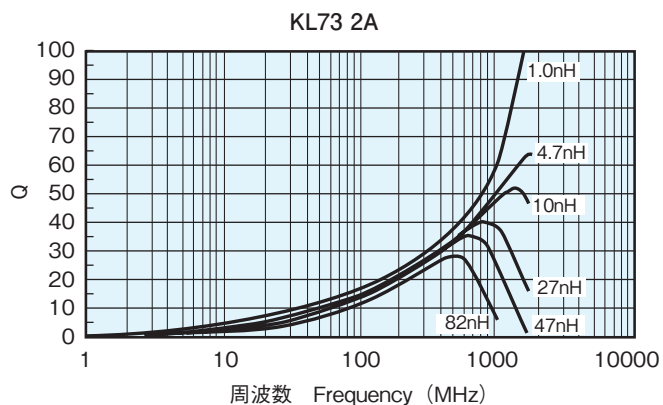
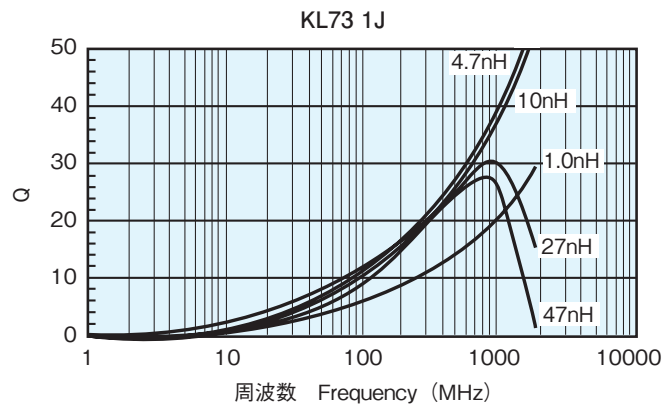
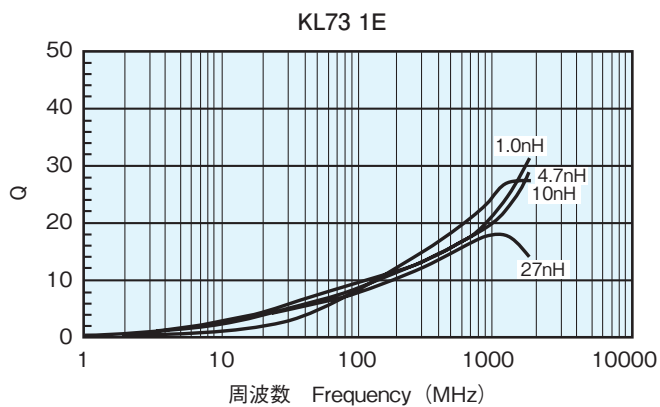

インダクタ  
Inductor