

EFDKA

Automotive metalized polypropylene film DC-link capacitors



Product features

- High capacitance density
- Self-healing property
- High ripple current and low loss
- High reliability
- AEC-Q200
- THB Grade IIIB

Applications

- xEV Traction inverter
- On board charger (OBC)
- xEV DC/DC converter
- Solar inverter
- UPS
- AC Motor drive
- Air conditioner
- Switch mode power supplies (SMPS)

Environmental compliance and general specifications

- Operating temperature range: -55 °C to +105 °C



Part number system

EF	DK	A	80	J	505	D07	2L	H
Capacitor type	Family	Grade	Voltage (Vdc)	Tolerance	Capacitance (pF)	Size code	Terminal code	Lead length code
EF = film capacitors	Radial leads DC link	A = automotive grade	45=450 55=550 60=600 70=700 80=800 90=900 1A=1000 1B=1100 1C=1200	J = ±5% K = ±10%	First two digits= significant figures, third digit = number of zeros example: 505 = 5000000 pF	Refer to size code table	Refer to terminal code table	Refer to lead length code table

Terminal code table

Digit one (Lead/terminal type)	Digit two (Lead Ipsilateral)
2 leads for straight cut	2 10.2 mm B
4 leads for straight cut	4 12.7 mm G
	20.3 mm D
	N/A L

Lead length code table

Lead length	Code
3.0 ±0.5 mm (Bulk)	D
3.5±0.5 mm (Bulk)	E
4.0 ±0.5 mm (Bulk)	F
4.5 ±0.5 mm (Bulk)	G
5.0 ±0.5 mm (Bulk)	H
5.5 ±0.5 mm (Bulk)	J
6.0 ±0.5 mm (Bulk)	K
6.5±0.5 mm (Bulk)	M
7.0 ±0.5 mm (Bulk)	N

Dimensions-mm

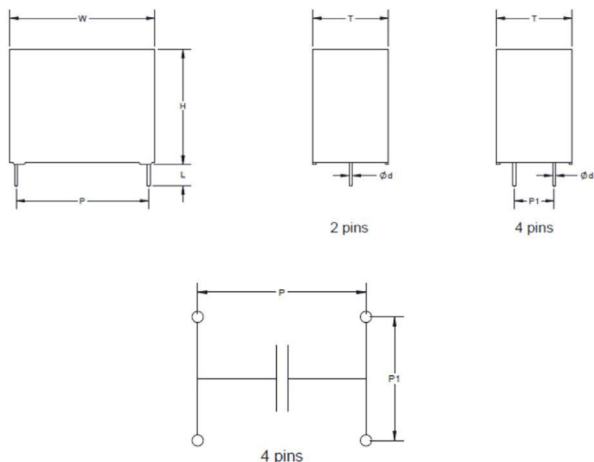

Part marking

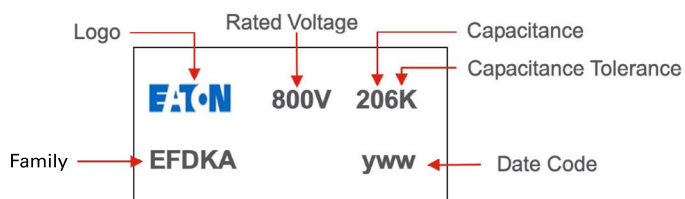

Size code table

Size	Dimension-mm						Pitch-mm				OD-mm			Lead length
	Code	W	Tolerance (±)	H	Tolerance (±)	T	Tolerance (±)	P	Tolerance (±)	P1	Tolerance (±)	4 leads	2 leads	
D02	32	0.8	18	0.8	9	0.8	27.5	0.5	\	\	\	0.8	0.05	Refer to Lead Length Code Table
D03	32	0.8	20	0.8	11	0.8	27.5	0.5	\	\	\	0.8	0.05	
D04	32	0.8	22	0.8	13	0.8	27.5	0.5	\	\	\	0.8	0.05	
D06	32	0.8	24.5	0.8	13	0.8	27.5	0.5	\	\	\	0.8	0.05	
D07	32	0.8	24.5	0.8	15	0.8	27.5	0.5	\	\	\	0.8	0.05	
D08	32	0.8	28	0.8	14	0.8	27.5	0.5	\	\	\	0.8	0.05	
D10	32	0.8	30	0.8	16	0.8	27.5	0.5	\	\	\	0.8	0.05	
D12	32	0.8	33	0.8	18	0.8	27.5	0.5	\	\	\	0.8	0.05	
D13	32	0.8	37	0.8	22	0.8	27.5	0.5	10.2	0.5	1	0.8	0.05	
E07	42	1	30	1	17	1	37.5	0.5	\	\	\	1	0.05	
E10	42	1	32	1	19	1	37.5	0.5	\	\	\	1	0.05	
E11	42	1	37	1	22	1	37.5	0.5	10.2	0.5	1.2	1	0.05	
E12	42	1	37	1	28	1	37.5	0.5	10.2	0.5	1.2	1	0.05	
E13	42	1	40	1	20	1	37.5	0.5	10.2	0.5	1.2	1	0.05	
E14	42	1	43	1	28	1	37.5	0.5	10.2	0.5	1.2	1	0.05	
E15	42	1	44	1	24	1	37.5	0.5	10.2	0.5	1.2	1	0.05	
E16	42	1	45	1	30	1	37.5	0.5	20.3	0.5	1.2	1	0.05	
E17	42	1	50	1	35	1	37.5	0.5	20.3	0.5	1.2	1	0.05	
E18	42	1	55	1	40	1	37.5	0.5	20.3	0.5	1.2	1	0.05	
E19	42	1	60	1	45	1	37.5	0.5	20.3	0.5	1.2	1	0.05	
F01	57.5	1	45	1	25	1	52.5	0.5	10.2	0.5	1.2	1.2	0.05	
F02	57.5	1	45	1	30	1	52.5	0.5	20.3	0.5	1.2	1.2	0.05	
F03	57.5	1	50	1	35	1	52.5	0.5	20.3	0.5	1.2	1.2	0.05	
F04	57.5	1	55	1	45	1	52.5	0.5	20.3	0.5	1.2	1.2	0.05	
F06	57.5	1	65	1	45	1	52.5	0.5	20.3	0.5	1.2	1.2	0.05	

Remark: case color is black.

Rating and part number

Rated voltage 450 Vdc

Capacitance value (μF)	Dimensions					I _{rms} +70 °C, 10 kHz (A)	Peak current (A)	Surge current (A)	ESR 10 kHz (mΩ)	ESL (nH)	Thermal resistance (°C/W)	dv/dt (V/μs)	Lead wire diameter (mm)	Part number ¹
	W (mm)	H (mm)	T (mm)	P (mm)	P1 (mm)									
5	32	20	11	27.5	\	5.0	325	975	20	25	30	65	0.8	EFDKA45J505D032LH
10	32	24.5	15	27.5	\	7.0	650	1950	11	25	27.8	65	0.8	EFDKA45J106D072LH
15	32	33	18	27.5	\	11	975	2925	7.0	25	17.7	65	0.8	EFDKA45J156D122LH
22	32	37	22	27.5	\	11	1430	4290	5.0	27	24.8	65	0.8	EFDKA45J226D132LH
25	32	37	22	27.5	\	12	1625	4875	4.8	27	24.8	65	0.8	EFDKA45J256D132LH
30	42	40	20	37.5	10.2	12.5	1050	3150	7.5	30	12.8	35	1.2	EFDKA45J306E134BH
35	42	37	22	37.5	10.2	13.5	1225	3675	7.0	30	11.8	35	1.2	EFDKA45J356E114BH
40	42	37	28	37.5	10.2	14.5	1400	4200	6.2	30	11.5	35	1.2	EFDKA45J406E124BH
50	42	43	28	37.5	10.2	16	1750	5250	5.0	30	11.7	35	1.2	EFDKA45J506E144BH
50	42	45	30	37.5	20.3	16	1750	5250	5.0	30	11.7	35	1.2	EFDKA45J506E164DH
60	42	45	30	37.5	20.3	16.5	2100	6300	4.5	30	12.2	35	1.2	EFDKA45J606E164DH
80	42	50	35	37.5	20.3	20.5	2800	8400	3.8	30	12.2	35	1.2	EFDKA45J806E174DH
110	42	60	45	37.5	20.3	24.5	3850	11550	3.6	30	12.2	35	1.2	EFDKA45J117E194DH
130	42	60	45	37.5	20.3	28.5	4550	13650	3.0	30	12.2	35	1.2	EFDKA45J137E194DH
75	57.5	45	30	52.5	20.3	16.5	1500	4500	5.5	35	10	20	1.2	EFDKA45J756F024DH
80	57.5	45	30	52.5	20.3	17	1600	4800	5.0	35	10.4	20	1.2	EFDKA45J806F024DH
100	57.5	50	35	52.5	20.3	18	2000	6000	4.5	35	10.3	20	1.2	EFDKA45J107F034DH
110	57.5	50	35	52.5	20.3	19	2200	6600	4.0	35	10.4	20	1.2	EFDKA45J117F034DH
120	57.5	50	35	52.5	20.3	21.5	2400	7200	3.8	35	10.4	20	1.2	EFDKA45J127F034DH
160	57.5	55	45	52.5	20.3	28.5	3200	9600	3.0	35	10.4	20	1.2	EFDKA45J167F044DH
200	57.5	65	45	52.5	20.3	33	4000	12000	2.6	35	10.4	20	1.2	EFDKA45J207F064DH

1. Standard part numbers listed--addition configurations available for tolerance, terminal and lead length. See part number system for available tolerances and terminal and lead length tables for available options.

Rating and part number

Rated voltage 550 Vdc

Capacitance value (μF)	Dimensions					I _{rms} +70 °C, 10 kHz (A)	Peak current (A)	Surge current (A)	ESR 10 kHz (mΩ)	ESL (nH)	Thermal resistance (°C/W)	dv/dt (V/μs)	Lead wire diameter (mm)	Part number ¹
	W (mm)	H (mm)	T (mm)	P (mm)	P1 (mm)									
5	32	22	13	27.5	\	5.5	325	975	19.5	25	25.4	65	0.8	EFDKA55J505D042LH
10	32	33	18	27.5	\	7.5	650	1950	10.5	25	25.4	65	0.8	EFDKA55J106D122LH
15	32	37	22	27.5	\	11.5	975	2925	6.8	27	16.7	65	0.8	EFDKA55J156D132LH
22	32	37	22	27.5	\	11.5	1430	4290	4.9	27	23.1	65	0.8	EFDKA55J226D132LH
30	42	44	24	37.5	10.2	13	1050	3150	7.2	30	12.3	35	1.2	EFDKA55J306E154BH
35	42	45	30	37.5	20.3	13.8	1225	3675	6.8	30	11.6	35	1.2	EFDKA55J356E164DH
40	42	45	30	37.5	20.3	14.8	1400	4200	6.0	30	11.4	35	1.2	EFDKA55J406E164DH
50	42	50	35	37.5	20.3	17	1750	5250	4.8	30	10.8	35	1.2	EFDKA55J506E174DH
60	42	50	35	37.5	20.3	18	2100	6300	4.2	30	11	35	1.2	EFDKA55J606E174DH
70	42	50	35	37.5	20.3	20.5	2450	7350	3.8	30	11	35	1.2	EFDKA55J706E174DH
110	42	60	45	37.5	20.3	24.5	3850	11550	3.6	30	11	35	1.2	EFDKA55J117E194DH
75	57.5	45	30	52.5	20.3	16.8	1500	4500	5.2	35	10.2	20	1.2	EFDKA55J756F024DH
100	57.5	50	35	52.5	20.3	18.5	2000	6000	4.3	35	10.2	20	1.2	EFDKA55J107F034DH
110	57.5	50	35	52.5	20.3	20	2200	6600	4.0	35	9.4	20	1.2	EFDKA55J117F034DH
140	57.5	55	45	52.5	20.3	26	2800	8400	3.5	35	6.3	20	1.2	EFDKA55J147F044DH
170	57.5	65	45	52.5	20.3	32	3400	10200	2.8	35	5.2	20	1.2	EFDKA55J177F064DH
180	57.5	65	45	52.5	20.3	33	3600	10800	2.6	35	5.2	20	1.2	EFDKA55J187F064DH

1. Standard part numbers listed---addition configurations available for tolerance, terminal and lead length. See part number system for available tolerances and terminal and lead length tables for available options.

Rating and part number

Rated voltage 600 Vdc

Capacitance value (μF)	Dimensions					I _{rms} +70 °C, 10 kHz (A)	Peak current (A)	Surge current (A)	ESR 10 kHz (mΩ)	ESL (nH)	Thermal resistance (°C/W)	dv/dt (V/μs)	Lead wire diameter (mm)	Part number ¹
	W (mm)	H (mm)	T (mm)	P (mm)	P1 (mm)									
2	32	18	9	27.5	\	2.9	130	390	40	25	44.6	65	0.8	EFDKA60J205D022LH
3	32	20	11	27.5	\	4.0	195	585	28	25	33.5	65	0.8	EFDKA60J305D032LH
4	32	20	11	27.5	\	5.5	260	780	23	25	21.6	65	0.8	EFDKA60J405D032LH
5	32	22	13	27.5	\	7.0	325	975	14.5	25	21.1	65	0.8	EFDKA60J505D042LH
6	32	24.5	15	27.5	\	7.3	390	1170	13	25	21.7	65	0.8	EFDKA60J605D072LH
7	32	24.5	15	27.5	\	8.5	455	1365	12	25	17.3	65	0.8	EFDKA60J705D072LH
8	32	28	14	27.5	\	9.5	520	1560	11	25	15.1	65	0.8	EFDKA60J805D082LH
9	32	30	16	27.5	\	10.5	585	1755	10.5	25	13	65	0.8	EFDKA60J905D102LH
10	32	30	16	27.5	\	11	650	1950	10	25	12.4	65	0.8	EFDKA60J106D102LH
12	32	33	18	27.5	\	12	780	2340	9.5	25	11	65	0.8	EFDKA60J126D122LH
15	32	37	22	27.5	\	12	975	2925	9.5	27	11	65	0.8	EFDKA60J156D132LH
15	32	37	22	27.5	10.2	14.5	975	2925	7.0	27	10.2	65	1	EFDKA60J156D134BH
18	32	37	22	27.5	\	12.5	1170	3510	9.0	27	10.7	65	0.8	EFDKA60J186D132LH
18	32	37	22	27.5	10.2	16.5	1170	3510	6.0	27	9.2	65	1	EFDKA60J186D134BH
10	42	30	17	37.5	\	7.0	350	1050	18	28	17	35	1	EFDKA60J106E072LH
12	42	30	17	37.5	\	8.0	420	1260	12	28	19.5	35	1	EFDKA60J126E072LH
15	42	32	19	37.5	\	9.5	525	1575	11	28	15.1	35	1	EFDKA60J156E102LH
20	42	40	20	37.5	10.2	12.5	700	2100	9.0	30	10.7	35	1.2	EFDKA60J206E134BH
22	42	40	20	37.5	10.2	13.5	770	2310	8.0	30	10.3	35	1.2	EFDKA60J226E134BH
25	42	40	20	37.5	10.2	15.5	875	2625	7.0	30	8.9	35	1.2	EFDKA60J256E134BH
30	42	44	24	37.5	10.2	16.5	1050	3150	6.5	30	8.5	35	1.2	EFDKA60J306E154BH
35	42	45	30	37.5	20.3	18.5	1225	3675	6.0	30	7.3	35	1.2	EFDKA60J356E164DH
40	42	45	30	37.5	20.3	20.5	1400	4200	5.0	30	7.1	35	1.2	EFDKA60J406E164DH
45	42	50	35	37.5	20.3	23	1575	4725	4.5	30	6.3	35	1.2	EFDKA60J456E174DH
50	42	50	35	37.5	20.3	25	1750	5250	4.0	30	6.0	35	1.2	EFDKA60J506E174DH
60	42	55	40	37.5	20.3	27	2100	6300	3.8	30	5.4	35	1.2	EFDKA60J606E184DH
70	42	55	40	37.5	20.3	29	2450	7350	3.5	30	5.1	35	1.2	EFDKA60J706E184DH
75	42	60	45	37.5	20.3	30	2625	7875	3.0	30	5.6	35	1.2	EFDKA60J756E194DH
80	42	60	45	37.5	20.3	32	2800	8400	2.8	30	5.2	35	1.2	EFDKA60J806E194DH
85	42	60	45	37.5	20.3	34	2975	8925	2.5	30	5.2	35	1.2	EFDKA60J856E194DH
40	57.5	45	25	52.5	10.2	13.5	800	2400	8.0	35	10.3	20	1.2	EFDKA60J406F014BH
45	57.5	45	25	52.5	10.2	14	900	2700	7.5	35	10.2	20	1.2	EFDKA60J456F014BH
50	57.5	45	25	52.5	10.2	15.5	1000	3000	7.0	35	8.9	20	1.2	EFDKA60J506F014BH
55	57.5	45	30	52.5	20.3	17	1100	3300	6.2	35	8.4	20	1.2	EFDKA60J556F024DH
60	57.5	45	30	52.5	20.3	18.5	1200	3600	6.0	35	7.3	20	1.2	EFDKA60J606F024DH
65	57.5	50	35	52.5	20.3	20	1300	3900	5.5	35	6.8	20	1.2	EFDKA60J656F034DH

1. Standard part numbers listed---addition configurations available for tolerance, terminal and lead length. See part number system for available tolerances and terminal and lead length tables for available options.

Rating and part number

Rated voltage 600 Vdc

Capacitance value (μF)	Dimensions					I _{rms} +70 °C, 10 kHz (A)	Peak current (A)	Surge current (A)	ESR 10 kHz (mΩ)	ESL (nH)	Thermal resistance (°C/W)	dv/dt (V/μs)	Lead wire diameter (mm)	Part number ¹
	W (mm)	H (mm)	T (mm)	P (mm)	P1 (mm)									
70	57.5	50	35	52.5	20.3	21.5	1400	4200	5.0	35	6.5	20	1.2	EFDKA60J706F034DH
75	57.5	50	35	52.5	20.3	23.5	1500	4500	4.5	35	6.0	20	1.2	EFDKA60J756F034DH
80	57.5	50	35	52.5	20.3	24.5	1600	4800	4.2	35	5.9	20	1.2	EFDKA60J806F034DH
90	57.5	55	45	52.5	20.3	26	1800	5400	4.0	35	5.5	20	1.2	EFDKA60J906F044DH
100	57.5	55	45	52.5	20.3	29	2000	6000	3.4	35	5.2	20	1.2	EFDKA60J107F044DH
110	57.5	55	45	52.5	20.3	30	2200	6600	3.0	35	5.6	20	1.2	EFDKA60J117F044DH
120	57.5	65	45	52.5	20.3	32	2400	7200	2.8	35	5.2	20	1.2	EFDKA60J127F064DH
130	57.5	65	45	52.5	20.3	33	2600	7800	2.6	35	5.3	20	1.2	EFDKA60J137F064DH
140	57.5	65	45	52.5	20.3	34	2800	8400	2.5	35	5.2	20	1.2	EFDKA60J147F064DH

1. Standard part numbers listed---addition configurations available for tolerance, terminal and lead length. See part number system for available tolerances and terminal and lead length tables for available options.

Rating and part number

Rated voltage 700 Vdc

Capacitance value (μF)	Dimensions					I _{rms} +70 °C, 10 kHz (A)	Peak current (A)	Surge current (A)	ESR 10 kHz (mΩ)	ESL (nH)	Thermal resistance (°C/W)	dv/dt (V/μs)	Lead wire diameter (mm)	Part number ¹
	W (mm)	H (mm)	T (mm)	P (mm)	P1 (mm)									
2	32	18	9	27.5	\	2.9	130	390	40	25	44.6	65	0.8	EFDKA70J205D022LH
3	32	20	11	27.5	\	4.0	195	585	28	25	33.5	65	0.8	EFDKA70J305D032LH
4	32	20	11	27.5	\	5.5	260	780	23	25	21.6	65	0.8	EFDKA70J405D032LH
5	32	22	13	27.5	\	7.0	325	975	14.5	25	21.1	65	0.8	EFDKA70J505D042LH
6	32	24.5	15	27.5	\	7.3	390	1170	13	25	21.7	65	0.8	EFDKA70J605D072LH
7	32	24.5	15	27.5	\	8.5	455	1365	12	25	17.3	65	0.8	EFDKA70J705D072LH
8	32	28	14	27.5	\	9.5	520	1560	11	25	15.1	65	0.8	EFDKA70J805D082LH
9	32	30	16	27.5	\	10.5	585	1755	10.5	25	13.0	65	0.8	EFDKA70J905D102LH
10	32	30	16	27.5	\	11	650	1950	10	25	12.4	65	0.8	EFDKA70J106D102LH
12	32	33	18	27.5	\	12	780	2340	9.5	25	11	65	0.8	EFDKA70J126D122LH
15	32	37	22	27.5	\	12	975	2925	9.5	27	11	65	0.8	EFDKA70J156D132LH
15	32	37	22	27.5	10.2	14.5	975	2925	7.0	27	10.2	65	1	EFDKA70J156D134BH
18	32	37	22	27.5	\	12.5	1170	3510	9.0	27	10.7	65	0.8	EFDKA70J186D132LH
18	32	37	22	27.5	10.2	16.5	1170	3510	6.0	27	9.2	65	1	EFDKA70J186D134BH
10	42	30	17	37.5	\	7.0	350	1050	18	28	17	35	1	EFDKA70J106E072LH
12	42	30	17	37.5	\	8.0	420	1260	12	28	19.5	35	1	EFDKA70J126E072LH
15	42	32	19	37.5	\	9.5	525	1575	11	28	15.1	35	1	EFDKA70J156E102LH
20	42	40	20	37.5	10.2	12.5	700	2100	9.0	30	10.7	35	1.2	EFDKA70J206E134BH
22	42	40	20	37.5	10.2	13.5	770	2310	8.0	30	10.3	35	1.2	EFDKA70J226E134BH
25	42	40	20	37.5	10.2	15.5	875	2625	7.0	30	8.9	35	1.2	EFDKA70J256E134BH
30	42	44	24	37.5	10.2	16.5	1050	3150	6.5	30	8.5	35	1.2	EFDKA70J306E154BH
35	42	45	30	37.5	20.3	18.5	1225	3675	6.0	30	7.3	35	1.2	EFDKA70J356E164DH
40	42	45	30	37.5	20.3	20.5	1400	4200	5.0	30	7.1	35	1.2	EFDKA70J406E164DH
45	42	50	35	37.5	20.3	23	1575	4725	4.5	30	6.3	35	1.2	EFDKA70J456E174DH
50	42	50	35	37.5	20.3	25	1750	5250	4.0	30	6.0	35	1.2	EFDKA70J506E174DH
60	42	55	40	37.5	20.3	27	2100	6300	3.8	30	5.4	35	1.2	EFDKA70J606E184DH
70	42	55	40	37.5	20.3	29	2450	7350	3.5	30	5.1	35	1.2	EFDKA70J706E184DH
75	42	60	45	37.5	20.3	30	2625	7875	3.0	30	5.6	35	1.2	EFDKA70J756E194DH
80	42	60	45	37.5	20.3	32	2800	8400	2.8	30	5.2	35	1.2	EFDKA70J806E194DH
85	42	60	45	37.5	20.3	34	2975	8925	2.5	30	5.2	35	1.2	EFDKA70J856E194DH
40	57.5	45	25	52.5	10.2	13.5	800	2400	8.0	35	10.3	20	1.2	EFDKA70J406F014BH
45	57.5	45	25	52.5	10.2	14	900	2700	7.5	35	10.2	20	1.2	EFDKA70J456F014BH
50	57.5	45	25	52.5	10.2	15.5	1000	3000	7.0	35	8.9	20	1.2	EFDKA70J506F014BH
55	57.5	45	30	52.5	20.3	17	1100	3300	6.2	35	8.4	20	1.2	EFDKA70J556F024DH
60	57.5	45	30	52.5	20.3	18.5	1200	3600	6.0	35	7.3	20	1.2	EFDKA70J606F024DH

1. Standard part numbers listed--addition configurations available for tolerance, terminal and lead length. See part number system for available tolerances and terminal and lead length tables for available options.

Rating and part number

Rated voltage 700 Vdc

Capacitance value (μF)	Dimensions					I _{rms} +70 °C, 10 kHz (A)	Peak current (A)	Surge current (A)	ESR 10 kHz (mΩ)	ESL (nH)	Thermal resistance (°C/W)	dv/dt (V/μs)	Lead wire diameter (mm)	Part number ¹
	W (mm)	H (mm)	T (mm)	P (mm)	P1 (mm)									
65	57.5	50	35	52.5	20.3	20	1300	3900	5.5	35	6.8	20	1.2	EFDKA70J656F034DH
70	57.5	50	35	52.5	20.3	21.5	1400	4200	5.0	35	6.5	20	1.2	EFDKA70J706F034DH
75	57.5	50	35	52.5	20.3	23.5	1500	4500	4.5	35	6.0	20	1.2	EFDKA70J756F034DH
80	57.5	50	35	52.5	20.3	24.5	1600	4800	4.2	35	5.9	20	1.2	EFDKA70J806F034DH
90	57.5	55	45	52.5	20.3	26	1800	5400	4.0	35	5.5	20	1.2	EFDKA70J906F044DH
100	57.5	55	45	52.5	20.3	29	2000	6000	3.4	35	5.2	20	1.2	EFDKA70J107F044DH
110	57.5	55	45	52.5	20.3	30	2200	6600	3.0	35	5.6	20	1.2	EFDKA70J117F044DH
120	57.5	65	45	52.5	20.3	32	2400	7200	2.8	35	5.2	20	1.2	EFDKA70J127F064DH
130	57.5	65	45	52.5	20.3	33	2600	7800	2.6	35	5.3	20	1.2	EFDKA70J137F064DH
140	57.5	65	45	52.5	20.3	34	2800	8400	2.5	35	5.2	20	1.2	EFDKA70J147F064DH

1. Standard part numbers listed---addition configurations available for tolerance, terminal and lead length. See part number system for available tolerances and terminal and lead length tables for available options.

Rating and part number

Rated voltage 800 Vdc

Capacitance value (μF)	Dimensions					I _{rms} +70 °C, 10 kHz (A)	Peak current (A)	Surge current (A)	ESR 10 kHz (mΩ)	ESL (nH)	Thermal resistance (°C/W)	dv/dt (V/μs)	Lead wire diameter (mm)	Part number ¹
	W (mm)	H (mm)	T (mm)	P (mm)	P1 (mm)									
2	32	18	9	27.5	\	2.9	130	390	40	25	44.6	65	0.8	EFDKA80J205D022LH
3	32	20	11	27.5	\	4.5	195	585	26	25	28.5	65	0.8	EFDKA80J305D032LH
4	32	24.5	13	27.5	\	5.8	260	780	22	25	20.3	65	0.8	EFDKA80J405D062LH
5	32	24.5	15	27.5	\	7.5	325	975	14	25	19	65	0.8	EFDKA80J505D072LH
6	32	30	16	27.5	\	8.5	390	1170	12	25	17.3	65	0.8	EFDKA80J605D102LH
7	32	30	16	27.5	\	9.5	455	1365	11	25	15.1	65	0.8	EFDKA80J705D102LH
8	32	33	18	27.5	\	10.5	520	1560	10.5	25	13	65	0.8	EFDKA80J805D122LH
9	32	33	18	27.5	\	11.5	585	1755	10.2	25	11.1	65	0.8	EFDKA80J905D122LH
10	32	37	22	27.5	\	12	650	1950	9.5	25	11	65	0.8	EFDKA80J106D132LH
10	32	37	22	27.5	10.2	14	650	1950	8.5	25	9.0	65	1	EFDKA80J106D134BH
12	32	37	22	27.5	\	12	780	2340	9.5	25	11	65	0.8	EFDKA80J126D132LH
12	32	37	22	27.5	10.2	15	780	2340	8.0	25	8.3	65	1	EFDKA80J126D134BH
14	32	37	22	27.5	\	12	910	2730	9.5	25	11	65	0.8	EFDKA80J146D132LH
14	32	37	22	27.5	10.2	16	910	2730	7.5	25	7.8	65	1	EFDKA80J146D134BH
8	42	30	17	37.5	\	5.5	280	840	22.5	28	22	35	1	EFDKA80J805E072LH
9	42	30	17	37.5	\	6.0	315	945	21.5	28	19.4	35	1	EFDKA80J905E072LH
10	42	32	19	37.5	\	7.0	350	1050	18	28	17	35	1	EFDKA80J106E102LH
12	42	32	19	37.5	\	8.0	420	1260	12	28	19.5	35	1	EFDKA80J126E102LH
14	42	32	19	37.5	\	9.5	490	1470	11	28	15.1	35	1	EFDKA80J146E102LH
15	42	40	20	37.5	10.2	12.5	525	1575	9.0	30	10.7	35	1.2	EFDKA80J156E134BH
20	42	44	24	37.5	10.2	13.5	700	2100	8.0	30	10.3	35	1.2	EFDKA80J206E154BH
25	42	44	24	37.5	10.2	16.5	875	2625	6.5	30	8.5	35	1.2	EFDKA80J256E154BH
30	42	45	30	37.5	20.3	20	1050	3150	5.8	30	6.5	35	1.2	EFDKA80J306E164DH
35	42	50	35	37.5	20.3	22	1225	3675	5.5	30	5.6	35	1.2	EFDKA80J356E174DH
40	42	50	35	37.5	20.3	25	1400	4200	4.8	30	5.0	35	1.2	EFDKA80J406E174DH
45	42	55	40	37.5	20.3	28	1575	4725	4.0	30	4.8	35	1.2	EFDKA80J456E184DH
50	42	55	40	37.5	20.3	31	1750	5250	3.6	30	4.3	35	1.2	EFDKA80J506E184DH
55	42	60	45	37.5	20.3	32.5	1925	5775	3.4	30	4.2	35	1.2	EFDKA80J556E194DH
60	42	60	45	37.5	20.3	34	2100	6300	3.2	30	4.1	35	1.2	EFDKA80J606E194DH
65	42	60	45	37.5	20.3	35	2275	6825	2.8	30	4.4	35	1.2	EFDKA80J656E194DH
25	57.5	45	25	52.5	10.2	8.5	500	1500	12	35	17.3	20	1.2	EFDKA80J256F014BH
30	57.5	45	25	52.5	10.2	10	600	1800	10.5	35	14.3	20	1.2	EFDKA80J306F014BH
35	57.5	45	25	52.5	10.2	12	700	2100	9.5	35	11	20	1.2	EFDKA80J356F014BH
40	57.5	45	30	52.5	20.3	14	800	2400	8.5	35	9.0	20	1.2	EFDKA80J406F024DH
45	57.5	45	30	52.5	20.3	15.5	900	2700	7.0	35	8.9	20	1.2	EFDKA80J456F024DH

1. Standard part numbers listed--addition configurations available for tolerance, terminal and lead length. See part number system for available tolerances and terminal and lead length tables for available options.

Rating and part number

Rated voltage 800 Vdc

Capacitance value (μF)	Dimensions					I _{rms} +70 °C, 10 kHz (A)	Peak current (A)	Surge current (A)	ESR 10 kHz (mΩ)	ESL (nH)	Thermal resistance (°C/W)	dv/dt (V/μs)	Lead wire diameter (mm)	Part number ¹
	W (mm)	H (mm)	T (mm)	P (mm)	P1 (mm)									
50	57.5	50	35	52.5	20.3	17	1000	3000	5.8	35	8.9	20	1.2	EFDKA80J506F034DH
55	57.5	50	35	52.5	20.3	19	1100	3300	5.5	35	7.6	20	1.2	EFDKA80J556F034DH
60	57.5	50	35	52.5	20.3	21	1200	3600	4.8	35	7.1	20	1.2	EFDKA80J606F034DH
65	57.5	55	45	52.5	20.3	22.5	1300	3900	4.6	35	6.4	20	1.2	EFDKA80J656F044DH
70	57.5	55	45	52.5	20.3	24	1400	4200	4.5	35	5.8	20	1.2	EFDKA80J706F044DH
75	57.5	55	45	52.5	20.3	25.5	1500	4500	4.3	35	5.4	20	1.2	EFDKA80J756F044DH
80	57.5	55	45	52.5	20.3	26	1600	4800	4.2	35	5.3	20	1.2	EFDKA80J806F044DH
90	57.5	55	45	52.5	20.3	27.5	1800	5400	4.0	35	5.0	20	1.2	EFDKA80J906F044DH
100	57.5	65	45	52.5	20.3	31.5	2000	6000	3.2	35	4.7	20	1.2	EFDKA80J107F064DH
110	57.5	65	45	52.5	20.3	34	2200	6600	3.0	35	4.3	20	1.2	EFDKA80J117F064DH

1. Standard part numbers listed---addition configurations available for tolerance, terminal and lead length. See part number system for available tolerances and terminal and lead length tables for available options.

Rating and part number

Rated voltage 900 Vdc

Capacitance value (μF)	Dimensions					I _{rms} +70 °C, 10 kHz (A)	Peak current (A)	Surge current (A)	ESR 10 kHz (mΩ)	ESL (nH)	Thermal resistance (°C/W)	dv/dt (V/μs)	Lead wire diameter (mm)	Part number ¹
	W (mm)	H (mm)	T (mm)	P (mm)	P1 (mm)									
1	32	18	9	27.5	\	2.0	70	210	65	25	57.7	70	0.8	EFDKA90J105D022LH
2	32	20	11	27.5	\	3.2	140	420	38	25	38.5	70	0.8	EFDKA90J205D032LH
3	32	22	13	27.5	\	4.8	210	630	30	25	21.7	70	0.8	EFDKA90J305D042LH
4	32	24.5	15	27.5	\	6.0	280	840	20.5	25	20.3	70	0.8	EFDKA90J405D072LH
5	32	30	16	27.5	\	7.5	350	1050	12	25	22.2	70	0.8	EFDKA90J505D102LH
6	32	33	18	27.5	\	7.8	420	1260	11.5	25	21.4	70	0.8	EFDKA90J605D122LH
7	32	33	18	27.5	\	10.5	490	1470	10.2	25	13.3	70	0.8	EFDKA90J705D122LH
8	32	37	22	27.5	\	11.5	560	1680	9.5	25	11.9	70	0.8	EFDKA90J805D132LH
8	32	37	22	27.5	10.2	12.5	560	1680	9.0	25	10.7	70	1	EFDKA90J805D134BH
9	32	37	22	27.5	\	11.8	630	1890	9.7	25	11.1	70	0.8	EFDKA90J905D132LH
9	32	37	22	27.5	10.2	14	630	1890	7.8	25	9.8	70	1	EFDKA90J905D134BH
10	32	37	22	27.5	\	12	700	2100	9.5	25	11	70	0.8	EFDKA90J106D132LH
10	32	37	22	27.5	10.2	15.5	700	2100	7.2	25	8.7	70	1	EFDKA90J106D134BH
5	42	30	17	37.5	\	3.8	175	525	28	28	37.1	35	1	EFDKA90J505E072LH
6	42	30	17	37.5	\	4.5	210	630	25	28	29.6	35	1	EFDKA90J605E072LH
7	42	30	17	37.5	\	5.0	245	735	22	28	27.3	35	1	EFDKA90J705E072LH
8	42	32	19	37.5	\	6.0	280	840	19.5	28	21.4	35	1	EFDKA90J805E102LH
10	42	40	20	37.5	10.2	7.5	350	1050	13	30	20.5	35	1.2	EFDKA90J106E134BH
12	42	37	22	37.5	10.2	9.0	420	1260	11.5	30	16.1	35	1.2	EFDKA90J126E114BH
15	42	44	24	37.5	10.2	10.5	525	1575	10.5	30	13	35	1.2	EFDKA90J156E154BH
18	42	44	24	37.5	10.2	13	630	1890	8.8	30	10.1	35	1.2	EFDKA90J186E154BH
20	42	44	24	37.5	10.2	14.5	700	2100	7.5	30	9.5	35	1.2	EFDKA90J206E154BH
25	42	45	30	37.5	20.3	17.5	875	2625	6.2	30	7.9	35	1.2	EFDKA90J256E164DH
30	42	50	35	37.5	20.3	21.5	1050	3150	5.0	30	6.5	35	1.2	EFDKA90J306E174DH
35	42	55	40	37.5	20.3	23	1225	3675	4.6	30	6.2	35	1.2	EFDKA90J356E184DH
40	42	55	40	37.5	20.3	26.5	1400	4200	3.9	30	5.5	35	1.2	EFDKA90J406E184DH
45	42	60	45	37.5	20.3	30	1575	4725	3.4	30	4.9	35	1.2	EFDKA90J456E194DH
50	42	60	45	37.5	20.3	33.5	1750	5250	3.0	30	4.5	35	1.2	EFDKA90J506E194DH
15	57.5	45	25	52.5	10.2	5.5	300	900	22	35	22.5	20	1.2	EFDKA90J156F014BH
20	57.5	45	25	52.5	10.2	7.5	400	1200	13.5	35	19.8	20	1.2	EFDKA90J206F014BH
25	57.5	45	25	52.5	10.2	9.0	500	1500	11.5	35	16.1	20	1.2	EFDKA90J256F014BH
30	57.5	45	30	52.5	20.3	11	600	1800	10.0	35	12.4	20	1.2	EFDKA90J306F024DH
35	57.5	45	30	52.5	20.3	12.5	700	2100	9.0	35	10.7	20	1.2	EFDKA90J356F024DH
40	57.5	50	35	52.5	20.3	14.5	800	2400	7.5	35	9.5	20	1.2	EFDKA90J406F034DH
45	57.5	50	35	52.5	20.3	16	900	2700	6.8	35	8.6	20	1.2	EFDKA90J456F034DH
50	57.5	50	35	52.5	20.3	18	1000	3000	6.4	35	7.2	20	1.2	EFDKA90J506F034DH

1. Standard part numbers listed---addition configurations available for tolerance, terminal and lead length. See part number system for available tolerances and terminal and lead length tables for available options.

Rating and part number

Rated voltage 900 Vdc

Capacitance value (μF)	Dimensions					I _{rms} +70 °C, 10 kHz (A)	Peak current (A)	Surge current (A)	ESR 10 kHz (mΩ)	ESL (nH)	Thermal resistance (°C/W)	dv/dt (V/μs)	Lead wire diameter (mm)	Part number ¹
	W (mm)	H (mm)	T (mm)	P (mm)	P1 (mm)									
55	57.5	55	45	52.5	20.3	20	1100	3300	5.6	35	6.7	20	1.2	EFDKA90J556F044DH
60	57.5	55	45	52.5	20.3	21.5	1200	3600	4.8	35	6.8	20	1.2	EFDKA90J606F044DH
65	57.5	55	45	52.5	20.3	23	1300	3900	4.5	35	6.3	20	1.2	EFDKA90J656F044DH
70	57.5	65	45	52.5	20.3	25	1400	4200	4.0	35	6.0	20	1.2	EFDKA90J706F064DH
75	57.5	65	45	52.5	20.3	25.5	1500	4500	3.9	35	5.9	20	1.2	EFDKA90J756F064DH
80	57.5	65	45	52.5	20.3	26.5	1600	4800	3.8	35	5.6	20	1.2	EFDKA90J806F064DH
85	57.5	65	45	52.5	20.3	28.5	1700	5100	3.6	35	5.1	20	1.2	EFDKA90J856F064DH

1. Standard part numbers listed---addition configurations available for tolerance, terminal and lead length. See part number system for available tolerances and terminal and lead length tables for available options.

Rating and part number

Rated voltage 1000 Vdc

Capacitance value (μF)	Dimensions					I _{rms} +70 °C, 10 kHz (A)	Peak current (A)	Surge current (A)	ESR 10 kHz (mΩ)	ESL (nH)	Thermal resistance (°C/W)	dv/dt (V/μs)	Lead wire diameter (mm)	Part number ¹
	W (mm)	H (mm)	T (mm)	P (mm)	P1 (mm)									
1	32	18	9	27.5	\	2.0	75	225	65	25	57.7	75	0.8	EFDKA1AJ105D022LH
2	32	22	13	27.5	\	3.5	150	450	38	25	32.2	75	0.8	EFDKA1AJ205D042LH
3	32	24.5	15	27.5	\	5.0	225	675	22	25	27.3	75	0.8	EFDKA1AJ305D072LH
4	32	30	16	27.5	\	7.0	300	900	16.5	25	18.6	75	0.8	EFDKA1AJ405D102LH
5	32	33	18	27.5	\	8.5	375	1125	12.5	25	16.6	75	0.8	EFDKA1AJ505D122LH
6	32	33	18	27.5	\	9.0	450	1350	11.5	25	16.1	75	0.8	EFDKA1AJ605D122LH
7	32	37	22	27.5	\	9.5	525	1575	11	25	15.1	75	0.8	EFDKA1AJ705D132LH
7	32	37	22	27.5	10.2	11.5	525	1575	9.8	25	11.6	75	1	EFDKA1AJ705D134BH
8	32	37	22	27.5	\	10.5	600	1800	10.5	25	13	75	0.8	EFDKA1AJ805D132LH
8	32	37	22	27.5	10.2	13	600	1800	8.8	25	10.1	75	1	EFDKA1AJ805D134BH
5	42	30	17	37.5	\	3.8	175	525	28	28	37.1	35	1	EFDKA1AJ505E072LH
6	42	30	17	37.5	\	4.5	210	630	25	28	29.6	35	1	EFDKA1AJ605E072LH
7	42	30	17	37.5	\	5.0	245	735	22	28	27.3	35	1	EFDKA1AJ705E072LH
8	42	32	19	37.5	\	6.0	280	840	19.5	28	21.4	35	1	EFDKA1AJ805E102LH
10	42	40	20	37.5	10.2	7.5	350	1050	13	30	20.5	35	1.2	EFDKA1AJ106E134BH
12	42	37	22	37.5	10.2	9.0	420	1260	11.5	30	16.1	35	1.2	EFDKA1AJ126E114BH
15	42	44	24	37.5	10.2	11.5	525	1575	10	30	11.3	35	1.2	EFDKA1AJ156E154BH
18	42	45	30	37.5	20.3	14	630	1890	7.8	30	9.8	35	1.2	EFDKA1AJ186E164DH
20	42	45	30	37.5	20.3	15.5	700	2100	7.0	30	8.9	35	1.2	EFDKA1AJ206E164DH
25	42	50	35	37.5	20.3	19.5	875	2625	5.5	30	7.2	35	1.2	EFDKA1AJ256E174DH
30	42	55	40	37.5	20.3	23	1050	3150	4.6	30	6.2	35	1.2	EFDKA1AJ306E184DH
35	42	55	40	37.5	20.3	25	1225	3675	4.0	30	6.0	35	1.2	EFDKA1AJ356E184DH
40	42	60	45	37.5	20.3	28.5	1400	4200	3.6	30	5.1	35	1.2	EFDKA1AJ406E194DH
15	57.5	45	25	52.5	10.2	5.8	300	900	19.8	35	22.5	20	1.2	EFDKA1AJ156F014BH
20	57.5	45	25	52.5	10.2	7.5	400	1200	13.5	35	19.8	20	1.2	EFDKA1AJ206F014BH
25	57.5	45	25	52.5	10.2	9.5	500	1500	11	35	15.1	20	1.2	EFDKA1AJ256F014BH
30	57.5	45	30	52.5	20.3	11.5	600	1800	9.8	35	11.6	20	1.2	EFDKA1AJ306F024DH
35	57.5	45	30	52.5	20.3	13.5	700	2100	8.0	35	10.3	20	1.2	EFDKA1AJ356F024DH
40	57.5	50	35	52.5	20.3	15.5	800	2400	7.0	35	8.9	20	1.2	EFDKA1AJ406F034DH
45	57.5	55	45	52.5	20.3	17.5	900	2700	6.2	35	7.9	20	1.2	EFDKA1AJ456F044DH
50	57.5	55	45	52.5	20.3	19.5	1000	3000	5.8	35	6.8	20	1.2	EFDKA1AJ506F044DH
55	57.5	55	45	52.5	20.3	21	1100	3300	5.0	35	6.8	20	1.2	EFDKA1AJ556F044DH
60	57.5	65	45	52.5	20.3	23	1200	3600	4.6	35	6.2	20	1.2	EFDKA1AJ606F064DH
65	57.5	65	45	52.5	20.3	25	1300	3900	4.2	35	5.7	20	1.2	EFDKA1AJ656F064DH
70	57.5	65	45	52.5	20.3	27	1400	4200	3.8	35	5.4	20	1.2	EFDKA1AJ706F064DH

1. Standard part numbers listed--additional configurations available for tolerance, terminal and lead length. See part number system for available tolerances and terminal and lead length tables for available options.

Rating and part number

Rated voltage 1100 Vdc

Capacitance value (µF)	Dimensions					I _{rms} +70 °C, 10 kHz (A)	Peak current (A)	Surge current (A)	ESR 10 kHz (mΩ)	ESL (nH)	Thermal resistance (°C/W)	dv/dt (V/µs)	Lead wire diameter (mm)	Part number ¹
	W (mm)	H (mm)	T (mm)	P (mm)	P1 (mm)									
1	32	20	11	27.5	\	2.2	80	240	65	25	47.7	80	0.8	EFDKA1BJ105D032LH
1.5	32	22	13	27.5	\	2.5	120	360	46	25	52.2	80	0.8	EFDKA1BJ155D042LH
2	32	24.5	13	27.5	\	4.8	160	480	24.5	25	26.6	80	0.8	EFDKA1BJ205D062LH
3	32	30	16	27.5	\	6.5	240	720	18.5	25	19.2	80	0.8	EFDKA1BJ305D102LH
4	32	33	18	27.5	\	8.5	320	960	12.5	25	16.6	80	0.8	EFDKA1BJ405D122LH
5	32	37	22	27.5	\	9.8	400	1200	10.8	25	14.5	80	0.8	EFDKA1BJ505D132LH
5	32	37	22	27.5	10.2	10.5	400	1200	10.5	25	13	80	1	EFDKA1BJ505D134BH
6	32	37	22	27.5	\	10.5	480	1440	10.5	25	13	80	0.8	EFDKA1BJ605D132LH
6	32	37	22	27.5	10.2	13	480	1440	8.8	25	10.1	80	1	EFDKA1BJ605D134BH
3	42	30	17	37.5	\	2.5	120	360	46	28	52.2	40	1	EFDKA1BJ305E072LH
4	42	30	17	37.5	\	3.5	160	480	32.5	28	37.7	40	1	EFDKA1BJ405E072LH
4.7	42	32	19	37.5	\	4.0	188	564	28	28	33.5	40	1	EFDKA1BJ475E102LH
5	42	32	19	37.5	\	4.2	200	600	26	28	32.7	40	1	EFDKA1BJ505E102LH
6	42	32	19	37.5	\	5.0	240	720	23.5	28	25.5	40	1	EFDKA1BJ605E102LH
7	42	40	20	37.5	10.2	6.0	280	840	18.5	30	22.5	40	1.2	EFDKA1BJ705E134BH
8	42	37	22	37.5	10.2	6.5	320	960	16.5	30	21.5	40	1.2	EFDKA1BJ805E114BH
9	42	37	22	37.5	10.2	7.5	360	1080	13	30	20.5	40	1.2	EFDKA1BJ905E114BH
10	42	44	24	37.5	10.2	8.5	400	1200	12	30	17.3	40	1.2	EFDKA1BJ106E154BH
12	42	44	24	37.5	10.2	10	480	1440	10.8	30	13.9	40	1.2	EFDKA1BJ126E154BH
14	42	45	30	37.5	20.3	12	560	1680	9.5	30	11	40	1.2	EFDKA1BJ146E164DH
15	42	45	30	37.5	20.3	13	600	1800	8.5	30	10.4	40	1.2	EFDKA1BJ156E164DH
18	42	50	35	37.5	20.3	15	720	2160	7.0	30	9.5	40	1.2	EFDKA1BJ186E174DH
20	42	50	35	37.5	20.3	16.5	800	2400	6.5	30	8.5	40	1.2	EFDKA1BJ206E174DH
25	42	55	40	37.5	20.3	20.5	1000	3000	5.0	30	7.1	40	1.2	EFDKA1BJ256E184DH
30	42	60	45	37.5	20.3	24.5	1200	3600	4.3	30	5.8	40	1.2	EFDKA1BJ306E194DH
15	57.5	45	25	52.5	10.2	6.5	300	900	16.5	35	21.5	20	1.2	EFDKA1BJ156F014BH
20	57.5	45	30	52.5	20.3	9.0	400	1200	11.5	35	16.1	20	1.2	EFDKA1BJ206F024DH
25	57.5	50	35	52.5	20.3	11	500	1500	10	35	12.4	20	1.2	EFDKA1BJ256F034DH
30	57.5	50	35	52.5	20.3	13	600	1800	8.6	35	10.3	20	1.2	EFDKA1BJ306F034DH
35	57.5	55	45	52.5	20.3	14.5	700	2100	7.5	35	9.5	20	1.2	EFDKA1BJ356F044DH
40	57.5	55	45	52.5	20.3	16	800	2400	6.8	35	8.6	20	1.2	EFDKA1BJ406F044DH
45	57.5	55	45	52.5	20.3	17.5	900	2700	6.2	35	7.9	20	1.2	EFDKA1BJ456F044DH
50	57.5	65	45	52.5	20.3	19.5	1000	3000	5.6	35	7.0	20	1.2	EFDKA1BJ506F064DH
55	57.5	65	45	52.5	20.3	21.5	1100	3300	4.8	35	6.8	20	1.2	EFDKA1BJ556F064DH

1. Standard part numbers listed--addition configurations available for tolerance, terminal and lead length. See part number system for available tolerances and terminal and lead length tables for available options.

Rating and part number

Rated voltage 1200 Vdc

Capacitance value (μF)	Dimensions					I _{rms} +70 °C, 10 kHz (A)	Peak current (A)	Surge current (A)	ESR 10 kHz (mΩ)	ESL (nH)	Thermal resistance (°C/W)	dv/dt (V/μs)	Lead wire diameter (mm)	Part number ¹
	W (mm)	H (mm)	T (mm)	P (mm)	P1 (mm)									
1	32	20	11	27.5	\	3.5	90	270	35	25	35	90	0.8	EFDKA1CJ105D032LH
2	32	24.5	15	27.5	\	5.0	180	540	24	25	25	90	0.8	EFDKA1CJ205D072LH
3	32	30	16	27.5	\	7.5	270	810	13	25	20.5	90	0.8	EFDKA1CJ305D102LH
4	32	33	18	27.5	\	9.5	360	1080	11	25	15.1	90	0.8	EFDKA1CJ405D122LH
5	32	37	22	27.5	\	10.5	450	1350	10.5	25	13	90	0.8	EFDKA1CJ505D132LH
5	32	37	22	27.5	10.2	12	450	1350	9.5	25	11	90	1	EFDKA1CJ505D134BH
3	42	30	17	37.5	\	3.2	135	405	35	28	41.9	45	1	EFDKA1CJ305E072LH
4	42	30	17	37.5	\	4.2	180	540	28	28	30.4	45	1	EFDKA1CJ405E072LH
5	42	32	19	37.5	\	5.5	225	675	21.5	28	23.1	45	1	EFDKA1CJ505E102LH
6	42	40	20	37.5	10.2	6.5	270	810	16.5	30	21.5	45	1.2	EFDKA1CJ605E134BH
7	42	37	22	37.5	10.2	7.5	315	945	13	30	20.5	45	1.2	EFDKA1CJ705E114BH
8	42	44	24	37.5	10.2	8.5	360	1080	12	30	17.3	45	1.2	EFDKA1CJ805E154BH
9	42	44	24	37.5	10.2	10	405	1215	10.8	30	13.9	45	1.2	EFDKA1CJ905E154BH
10	42	44	24	37.5	10.2	11	450	1350	10	30	12.4	45	1.2	EFDKA1CJ106E154BH
12	42	45	30	37.5	20.3	13	540	1620	8.5	30	10.4	45	1.2	EFDKA1CJ126E164DH
15	42	50	35	37.5	20.3	16	675	2025	6.8	30	8.6	45	1.2	EFDKA1CJ156E174DH
18	42	50	35	37.5	20.3	18	810	2430	6.2	30	7.5	45	1.2	EFDKA1CJ186E174DH
20	42	55	40	37.5	20.3	20	900	2700	5.5	30	6.8	45	1.2	EFDKA1CJ206E184DH
25	42	60	45	37.5	20.3	25	1125	3375	4.3	30	5.6	45	1.2	EFDKA1CJ256E194DH
12	57.5	45	25	52.5	10.2	6.5	300	900	16.5	35	21.5	25	1.2	EFDKA1CJ126F014BH
15	57.5	45	25	52.5	10.2	7.5	375	1125	13	35	20.5	25	1.2	EFDKA1CJ156F014BH
20	57.5	45	30	52.5	20.3	11	500	1500	10	35	12.4	25	1.2	EFDKA1CJ206F024DH
25	57.5	50	35	52.5	20.3	13	625	1875	8.6	35	10.3	25	1.2	EFDKA1CJ256F034DH
30	57.5	55	45	52.5	20.3	14.5	750	2250	7.5	35	9.5	25	1.2	EFDKA1CJ306F044DH
35	57.5	55	45	52.5	20.3	16	875	2625	6.8	35	8.6	25	1.2	EFDKA1CJ356F044DH
40	57.5	65	45	52.5	20.3	20	1000	3000	5.5	35	6.8	25	1.2	EFDKA1CJ406F064DH
45	57.5	65	45	52.5	20.3	22.5	1125	3375	4.8	35	6.2	25	1.2	EFDKA1CJ456F064DH

1. Standard part numbers listed---addition configurations available for tolerance, terminal and lead length. See part number system for available tolerances and terminal and lead length tables for available options.

General information

Application	DC Link / DC Filtering
Dielectric	Metallized Polypropylene Film
Reference standard	IEC 61071/EN 61071, AEC-Q200D
Climatic category	55/105/56 IEC60068-1
Operating temperature range	-55 °C to +105 °C, (derate working voltage [U_R] by 1.25% for +85 °C to +105 °C)
Protection	Solvent resistant plastic case UL94 V-0, Thermosetting resin sealing UL 94V-0 compliant
Installation	Any position
Packaging	Packed in cardboard boxes with protection for the terminals
Storage conditions	Storage time: ≤24 months from the date marked on the package label, Average relative humidity per year ≤70%, RH≤85% for 30 days in one year, Dew is absent, Temperature: -40 °C to +85 °C
RoHS compliant	Compliant with the restricted substance requirements of Directive 2011/65/EU
Flame retardant grade	Flame retardant performance accords with horizontal combustion grade HB and vertical combustion grade V-0
Application note and limiting conditions	These capacitors are designed only for DC voltage so should not be used for AC line. The continuous peak voltage shall not exceed the rated DC voltage rating

Construction

Metallized film	OPP & Al/Zn
Metal sprayed	Sn/Zn Alloy
Connection electrode	Tinned copper wires
Plastic case	Plastic Case (UL94V-0)
Filling	Epoxy Resin (UL94V-0)

Film construction

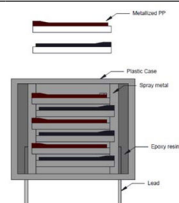

Electrical and general characteristics

Voltage range (U_R)	450 Vdc to 1200 Vdc
Capacitance range	1.0 μ F to 200 μ F
Capacitance tolerance	±5% or ±10% at +20 °C
Capacitance	Measuring frequency at 1 kHz, +20 °C Measuring voltage: 1.0 ±0.2 V
Standard atmospheric conditions for static test	Ambient temperature +15 °C to +35 °C Relative humidity 45% to 75% Air pressure 86 kPa to 106 kPa
Withstanding DC voltage between terminals U_{TT}	1.5 x U_R for 10 seconds (between terminations) @ +20 °C ±5 °C
Withstanding AC voltage between terminal and case U_{TC}	3000 Vac, 50/60 Hz 60 s (at +20 ±5 °C)
Dissipation factor	≤20 × 10 ⁻⁴ at 1 kHz; C ≤20 μ F at +20 °C ≤30 × 10 ⁻⁴ at 1 kHz; 20 μ F < C ≤80 μ F at +20 °C ≤40 × 10 ⁻⁴ at 1 kHz; C >80 μ F at +20 °C
Insulation resistance	RC between leads, at 100 V +20 °C; 1 minute > 30,000 M Ω * μ F
Self-inductance	<1 nH per mm of lead spacing
Life expectancy	100,000 hours (U_R hotspot = +85 °C) ($\Delta C/C$ ≤5%)
Failure rate	100 FIT
Maximum altitude	2000 m
Overtolerance	Maximum duration within one day: Apply 110% of rated voltage 30% of on-load duration Apply 115% of rated voltage 30 minutes Apply 120% of rated voltage 5 minutes Apply 130% of rated voltage 1 minute

Characteristics curves

Expected life curve

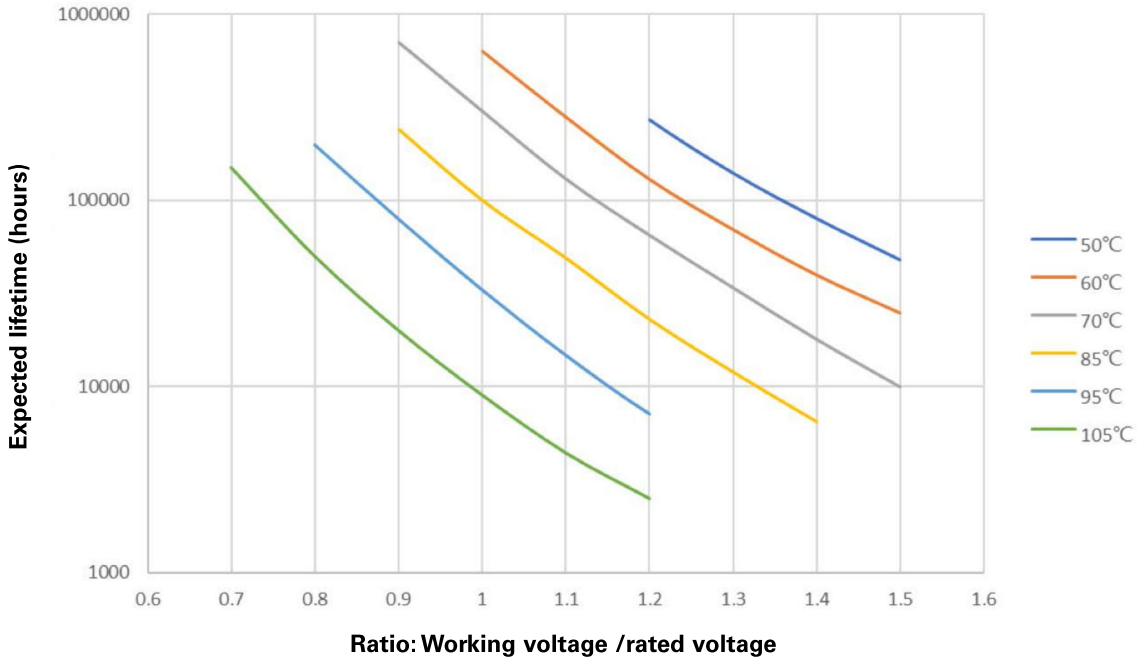

Derating of U_R vs temperature

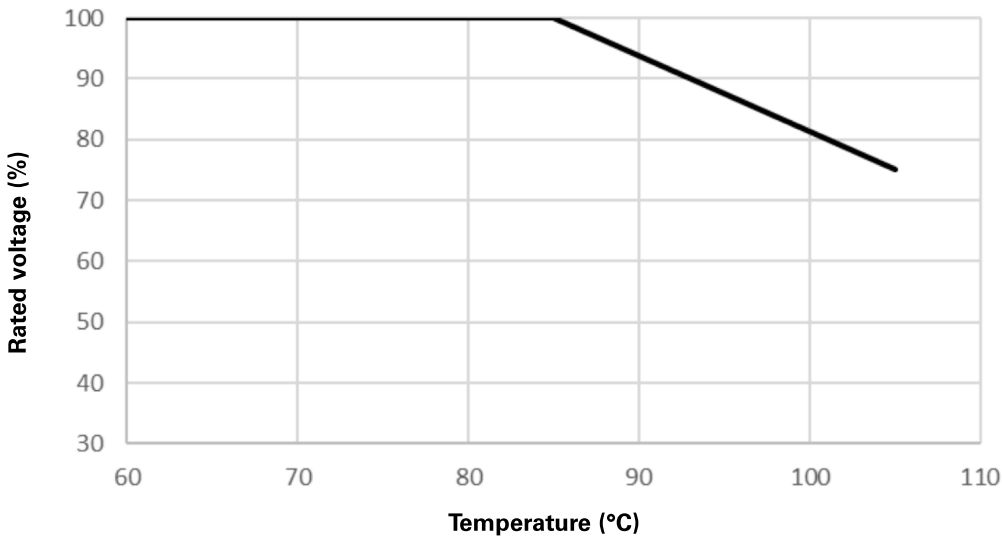

Characteristics curves

Derating of I_{rms} vs temperature

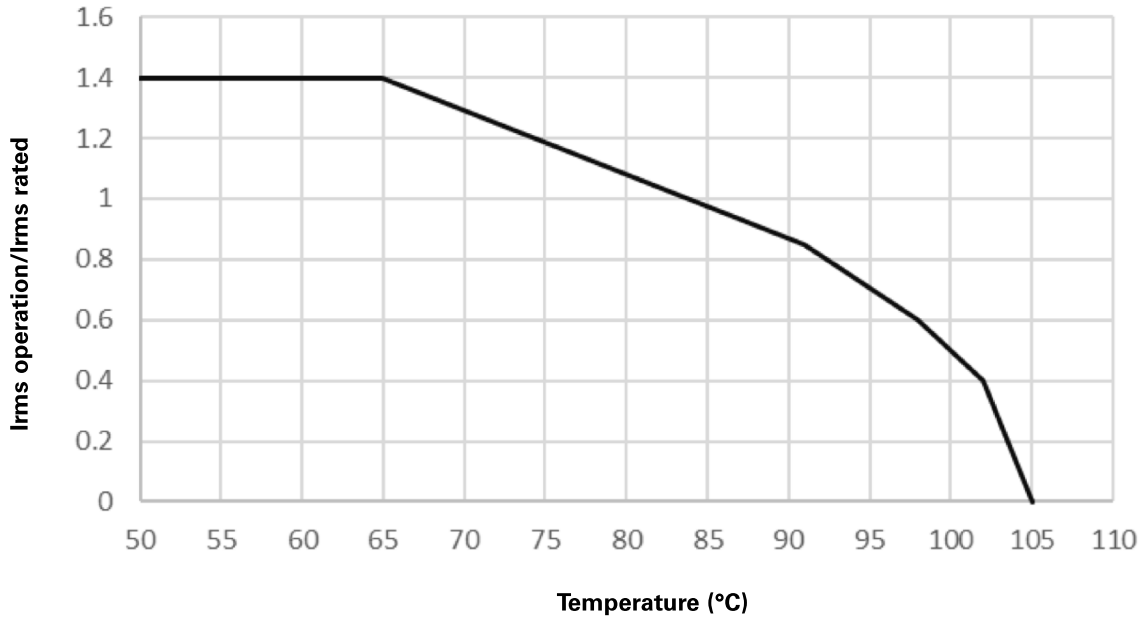

Impedance vs frequency

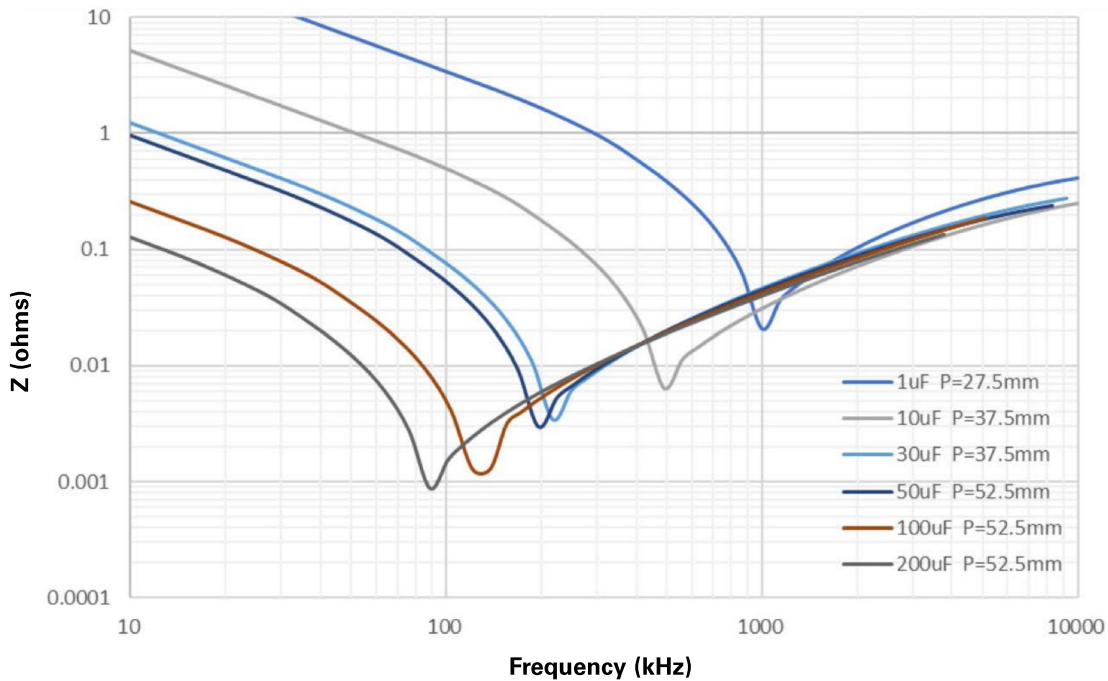

Environmental test

Test	Test condition	Performance
High temperature exposure	Reference: MIL-STD-202 Method 108, +105 +/- 2 °C 1000 hours	Capacitance change rate ($\Delta C/C$): $\leq \pm 3\%$ DF change ($\Delta tg\delta$): $\leq 50 \cdot 10^{-4}$ at 1 kHz Insulation resistance: $\geq 50\%$ of initial limit (T-T) test voltage: $1.5 \times U_p/10$ s (T-C) test voltage: 3000 Vac/60 s ESR change rate ($\Delta ESR / ESR$): $\leq \pm 300\%$
Temperature cycling	Reference: JESD22 Method JA-104, High temperature: +105 +/-5 °C, Low temperature: -55 +/-5 °C, 1000 cycles, 30 minutes for each temperature	Capacitance change rate ($\Delta C/C$): $\leq \pm 5\%$ DF change ($\Delta tg\delta$): $\leq 50 \cdot 10^{-4}$ at 1 kHz Insulation resistance: $\geq 50\%$ of initial limit (T-T) test voltage: $1.5 \times U_p/10$ s (T-C) test voltage: 3000 Vac/60 s ESR change rate ($\Delta ESR / ESR$): $\leq \pm 300\%$
Moisture resistance	Reference: MIL-STD-202 Method 106 (+25 °C to 65 °C for 2.5 hours), (+65 °C for 3 hours), (+65 °C to +25 °C for 2.5 hours), (+25 °C to +65 °C for 2.5 hours), (+65 °C for 3 hours), (+65 °C to +25 °C for 2.5 hours) , (+25 °C for 8 hours) Keep humidity 90%~100% for 10 cycles	Capacitance change rate ($\Delta C/C$): $\leq \pm 5\%$ DF change ($\Delta tg\delta$): $\leq 50 \cdot 10^{-4}$ at 1 kHz Insulation resistance: $\geq 50\%$ of initial limit (T-T) test voltage: $1.5 \times U_p/10$ s (T-C) test voltage: 3000 Vac/60 s ESR change rate ($\Delta ESR / ESR$): $\leq \pm 300\%$
Biased humidity 1	Reference: MIL-STD-202 Method 103, 60 °C + 95% R.H, Rated voltage, 1000 hours	Capacitance change rate ($\Delta C/C$): $\leq \pm 5\%$ DF change ($\Delta tg\delta$): $\leq 50 \cdot 10^{-4}$ at 1 kHz Insulation resistance: $\geq 50\%$ of initial limit (T-T) test voltage: $1.5 \times U_p/10$ s (T-C) test voltage: 3000 Vac/60 s ESR change rate ($\Delta ESR / ESR$): $\leq \pm 300\%$
Biased humidity 2	Reference: MIL-STD-202 Method 103, 85 °C + 85% R.H, Rated voltage, 1000 hours	Capacitance change rate ($\Delta C/C$): $\leq \pm 10\%$ DF change ($\Delta tg\delta$): $\leq 50 \cdot 10^{-4}$ at 1 kHz Insulation resistance: $\geq 50\%$ of initial limit (T-T) test voltage: $1.5 \times U_p/10$ s (T-C) test voltage: 3000 Vac/60 s ESR change rate ($\Delta ESR / ESR$): $\leq \pm 300\%$
Operational life	Testing method per IEC 61071, Test temperature: +105 +/-2 °C., Apply 130% of (75% rated voltage) for 1,000 +24/-0 hours. Duration: 500 hours, 1000 charges and discharges at 1.4 x I peak (maximum respective peak current in continuous operation)	Capacitance change rate ($\Delta C/C$): $\leq \pm 5\%$ DF change ($\Delta tg\delta$): $\leq 50 \cdot 10^{-4}$ at 1 kHz Insulation resistance: $\geq 50\%$ of initial limit (T-T) test voltage: $1.5 \times U_p/10$ s (T-C) test voltage: 3000 Vac/60 s ESR change rate ($\Delta ESR / ESR$): $\leq \pm 300\%$
Terminal strength (lead)	Tension: $0.50 < D \leq 0.80$, 10 N, $0.80 < D \leq 1.25$, 20 N Bending force: $0.50 < D \leq 0.80$, 5 N, $0.80 < D \leq 1.25$, 10 N Make two successive bends in each direction	Shall be no abnormality
Resistance to solvents	Reference: MIL-STD-202 Method 215, Solvent: propa- nol, Immersion time: 3 minutes, Drying time: 5 minutes, Mechanical treatment: 10 rubbing (toothbrush), 3 cycles	Capacitance change rate ($\Delta C/C$): $\leq \pm 1\%$ DF change ($\Delta tg\delta$): $\leq 50 \cdot 10^{-4}$ at 1 kHz Insulation resistance: $\geq 50\%$ of initial limit (T-T) test voltage: $1.5 \times U_p/10$ s (T-C) test voltage: 3000 Vac/60 s ESR change rate ($\Delta ESR / ESR$): $\leq \pm 300\%$
Mechanical shock	Reference: MIL-STD-202 Method 213, Pulse-shape: half-sine wave, Acceleration: 100 g, Duration of pulse: 6 ms, 18 times	Capacitance change rate ($\Delta C/C$): $\leq \pm 1\%$ DF change ($\Delta tg\delta$): $\leq 50 \cdot 10^{-4}$ at 1 kHz Insulation resistance: $\geq 50\%$ of initial limit (T-T) test voltage: $1.5 \times U_p/10$ s (T-C) test voltage: 3000 Vac/60 s ESR change rate ($\Delta ESR / ESR$): $\leq \pm 300\%$
Vibration	Reference: MIL-STD-202 Method 204, Frequency Change: 10 ~ 2000 Hz, 5 g force, 20 minutes, Direction: X, Y, Z, 12 cycles in each direction	Capacitance change rate ($\Delta C/C$): $\leq \pm 1\%$ DF change ($\Delta tg\delta$): $\leq 50 \cdot 10^{-4}$ at 1 kHz Insulation resistance: $\geq 50\%$ of initial limit (T-T) test voltage: $1.5 \times U_p/10$ s (T-C) test voltage: 3000 Vac/60 s ESR change rate ($\Delta ESR / ESR$): $\leq \pm 300\%$
Resistance to soldering heat	Reference: MIL-STD-202 Method 210, +260 +/- 5 °C 1.5 mm from roots	Capacitance change rate ($\Delta C/C$): $\leq \pm 0.5\%$ DF change ($\Delta tg\delta$): $\leq 50 \cdot 10^{-4}$ at 1 kHz Insulation resistance: $\geq 50\%$ of initial limit (T-T) test voltage: $1.5 \times U_p/10$ s (T-C) test voltage: 3000 Vac/60 s ESR change rate ($\Delta ESR / ESR$): $\leq \pm 300\%$
Solderability	Reference: J-STD-002, Soldering temperature: +245 +/-5 °C	More than 95% of circumferential surface of lead wire shall be covered with new solder

Environmental test

Test	Test condition	Performance
Electrical characterization	Parametrically test per lot at room, -55 °C, 105 °C	Capacitance change rate ($\Delta C/C$): $\leq \pm 5\%$ DF change ($\Delta tg\delta$): $\leq 50 \cdot 10^{-4}$ at 1 kHz Insulation resistance: $\geq 50\%$ of initial limit (T-T) test voltage: $1.5 \times U_R/10$ s (T-C) test voltage: 3000 Vac/60 s ESR change rate ($\Delta ESR / ESR$): $\leq \pm 300\%$
Passive flammability class B	Test duration for actual volume V $V \leq 250$ for 10 s $250 < V \leq 500$ for 20 s $500 < V \leq 1750$ for 30 s $V > 1750$ for 60 s	After removing test flame from capacitor, the capacitor must not continue to burn for more than 10 seconds. No burning particle must drop from the sample.
Humidity resistance	Reference: MIL-STD-202 Method 106, 40 +/-2 °C 90% to 95% R.H, 56 days	Capacitance change rate ($\Delta C/C$): $\leq \pm 5\%$ DF change ($\Delta tg\delta$): $\leq 50 \cdot 10^{-4}$ at 1 kHz Insulation resistance: $\geq 50\%$ of initial limit (T-T) test voltage: $1.5 \times U_R/10$ s (T-C) test voltage: 3000 Vac/60 s ESR change rate ($\Delta ESR / ESR$): $\leq \pm 300\%$

Electrical test

Test	Test condition	Performance
Self healing test	Apply 150% of rated voltage Duration: 10 seconds Number of clearings ≤ 5 Clearing = voltage drop of 5 % increase the voltage at 100 V/s till 5 clearings occur with a maximum of $2.5 \times U$ NDC for a duration of 10 seconds	Capacitance change rate ($\Delta C/C$): $\leq \pm 0.5\%$ DF change ($\Delta tg\delta$): $\leq 50 \cdot 10^{-4}$ at 1 kHz Insulation resistance: $\geq 50\%$ of initial limit (T-T) test voltage: $1.5 \times U_R/10$ s (T-C) test voltage: 3000 Vac/60 s ESR change rate ($\Delta ESR / ESR$): $\leq \pm 300\%$
Surge discharge test	Five charges and discharges in ten minutes. Test voltage: 1.1 UR Test current: 1.1 times the maximum impulse current The interelectrode withstand voltage was tested within five minutes after the test.	Capacitance change rate ($\Delta C/C$): $\leq \pm 1\%$ DF change ($\Delta tg\delta$): $\leq 50 \cdot 10^{-4}$ at 1 kHz Insulation resistance: $\geq 50\%$ of initial limit (T-T) test voltage: $1.5 \times U_R/10$ s (T-C) test voltage: 3000 Vac/60 s ESR change rate ($\Delta ESR / ESR$): $\leq \pm 300\%$
Thermal stability	Temperature: ambient temperature Test current: 1.1 Irms Test frequency: 10 kHz Test time: 48 hours. During, the last 6 hours, the temperature of the case near of the top rise shall be measured per 1.5 hours.	Capacitance change rate ($\Delta C/C$): $\leq \pm 2\%$ DF change ($\Delta tg\delta$): $\leq 50 \cdot 10^{-4}$ at 1 kHz Insulation resistance: $\geq 50\%$ of initial limit (T-T) test voltage: $1.5 \times U_R/10$ s (T-C) test voltage: 3000 Vac/60 s ESR change rate ($\Delta ESR / ESR$): $\leq \pm 300\%$

Packaging information

Pitch mm	Size	Dimension-mm			Package quantity
	Code	W	H	T	Bulk pack/box
27.5	D02	32	18	9	340
	D03	32	20	11	280
	D04	32	22	13	230
	D06	32	24.5	13	230
	D07	32	24.5	15	200
	D08	32	28	14	220
	D10	32	30	16	190
	D12	32	33	18	170
	D13	32	37	22	140
37.5	E07	42	30	17	126
	E10	42	32	19	112
	E11	42	37	22	98
	E12	42	37	28	77
	E13	42	40	20	105
	E14	42	43	28	77
	E15	42	44	24	91
	E16	42	45	30	70
	E17	42	50	35	63
52.5	E18	42	55	40	49
	E19	42	60	45	49
	F01	57.5	45	25	60
	F02	57.5	45	30	50
	F03	57.5	50	35	45
	F04	57.5	55	45	35
	F06	57.5	65	45	35

Wave solder profile

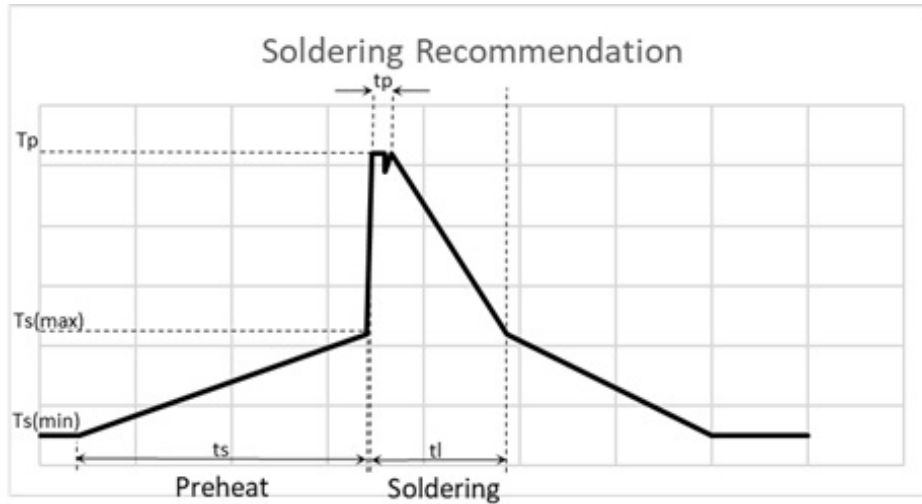

Profile feature

Preheat	• T_s maximum	110 °C
	• T_s minimum	NA
	• t_s	< 150 seconds
Soldering	• T_p	260 °C ±5 °C
	• t_p	< 10 seconds
	• t_l	≤60 seconds

Capacitor body maximum temperature at wave soldering ≤120 °C

Manual solder

+400 °C, 3 seconds maximum by soldering iron, generally manual, hand soldering is not recommended

Life Support Policy: Eaton does not authorize the use of any of its products for use in life support devices or systems without the express written approval of an officer of the Company. Life support systems are devices which support or sustain life, and whose failure to perform, when properly used in accordance with instructions for use provided in the labeling, can be reasonably expected to result in significant injury to the user.

Eaton reserves the right, without notice, to change design or construction of any products and to discontinue or limit distribution of any products. Eaton also reserves the right to change or update, without notice, any technical information contained in this bulletin.

Eaton
Electronics Division
1000 Eaton Boulevard
Cleveland, OH 44122
United States
Eaton.com/electronics

© 2023 Eaton
All Rights Reserved
Printed in USA
Publication No. ELX1264 BU-ELX22128
May 2023

Eaton is a registered trademark.

All other trademarks are property of their respective owners.

Follow us on social media to get the latest product and support information.

