



HYBRID & ELECTRIC VEHICLE CONNECTION SYSTEM

Off-the-shelf Portfolio



• APTIV •

At Aptiv, we are born to move

Aptiv is a **global technology company** that develops safer, greener and more connected solutions enabling the future of mobility.

Headquartered in Dublin, Aptiv has approximately 160,000 employees and operates 15 technical centers, as well as manufacturing sites and customer support centers in 45 countries.

VISIT [APTIV.COM](https://www.aptiv.com) →

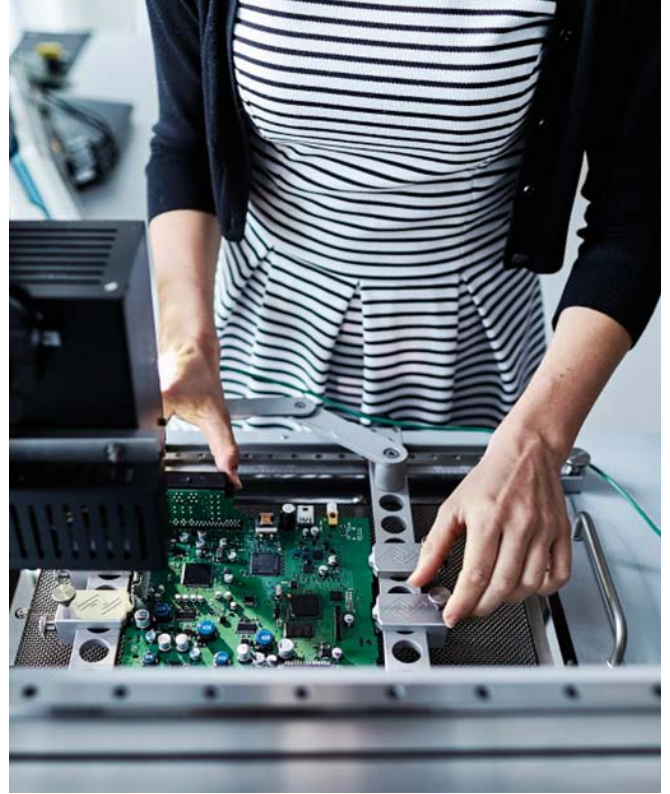

Aptiv is ready when and where you need us

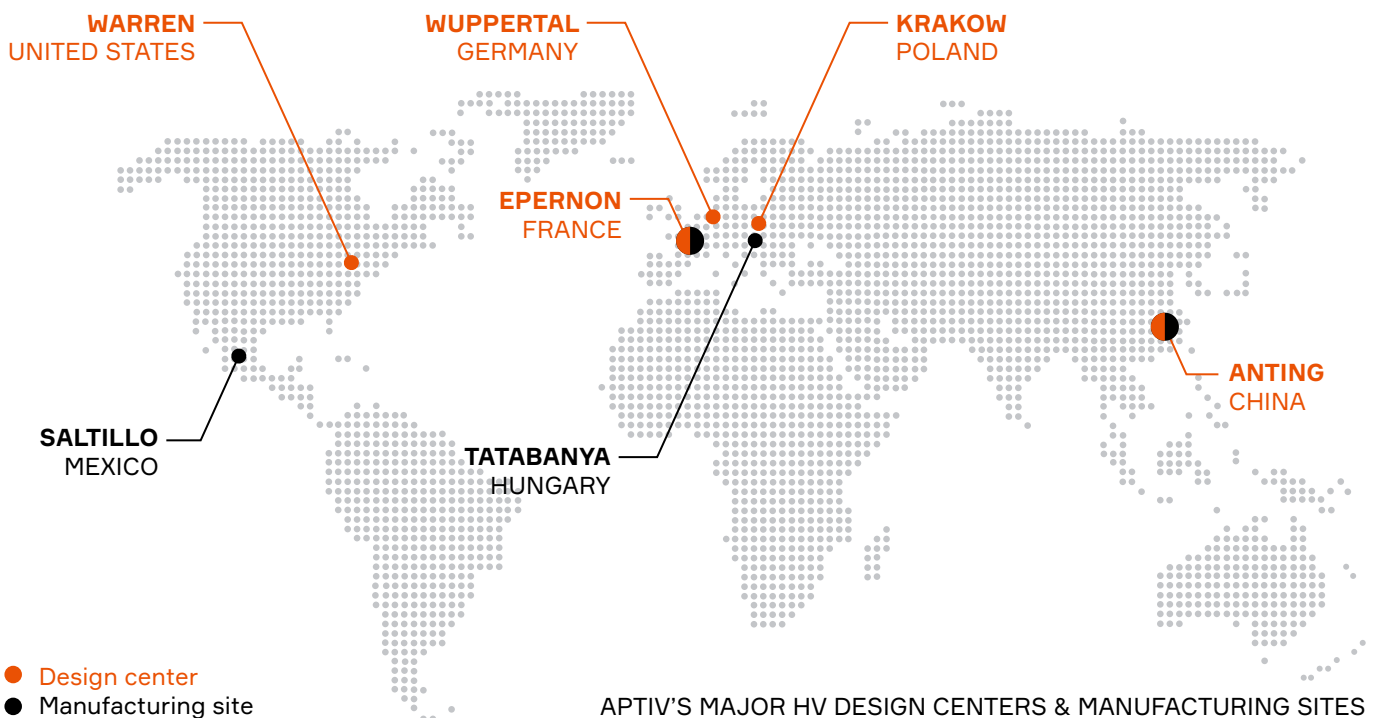

The world of transportation

Aptiv has been a trusted automotive supplier for decades, introducing practical innovations in the areas of safety, efficiency, and connectivity.

The transportation market has been advancing in these areas and Aptiv can offer product solutions designed for the tougher operational and environmental requirements.

Commercial and recreation vehicles are often exposed to higher levels of environmental forces, including vibration, dust, water, debris, and temperature. To protect the integrity of the electrical system, high performance connection systems are required.

To deliver superior performance, a number of complex factors in the electrical system must be addressed in the component design, including sealing, locking features, and materials.



Image Source : PSA

Did you KNOW?

Hybrid and electric vehicles are creating a host of challenges, including the demand for a new generation of high performance, high

power connectors and charging solutions. Many additional power electronics devices are added to the vehicle architecture including lithium-ion (Li-ion) batteries, inverters and DC (Direct Current) converters. Their impact on connector design results in handling operation voltages that range from 400V up to 1000 V and carrying currents as high as 250A.



Why is vehicle electrification now a reality?



ENVIRONMENTAL
CONCERNS



GOVERNMENT
REGULATIONS AND
INCENTIVES

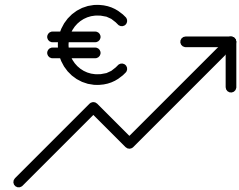

IMPROVING ECONOMIC
STANDARDS



Driven by environmental concerns and a combination of government regulations and incentives, the market for EVs (Electric Vehicles) and HEVs (Hybrid Electric Vehicles) is now becoming a reality. In addition, EVs and HEVs reduce the dependence on potential oil price increases.

Aptiv is currently driving the innovations required for future multi-voltage architectures. Our research and development teams have leveraged the lessons learned from the collaboration with OEM's to focus on technological excellence and to provide real-life electrification performance.

With a unique expertise in architecture optimization and systems integration, Aptiv has created one of the most comprehensive portfolios of the high power connection systems.

Superior Sealing Performances



All of our mated connection systems feature at least external IP67 sealing performance.

To ensure optimum sealing performance, our connectors are designed for the harshest conditions due to a back sealing feature.

Superior Shielding Performances



EV and HEV electrical and electronic systems generate unwanted electromagnetic interference (EMI) which radiate from the interconnecting cables. The connection systems are designed by minimizing the paths along which these signals can escape. Our connectors and cabling designs provide high levels of shielding effectiveness to ensure EMI free performance of the complete system.

Superior Safety Performances

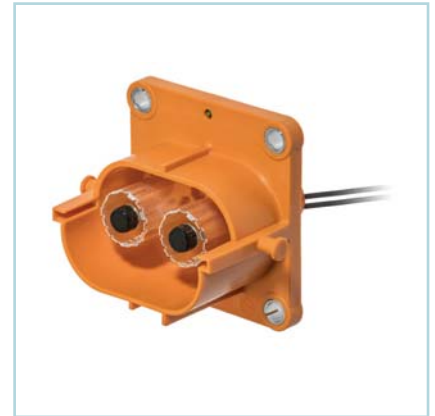

Our connectors provide finger-proof, 2-step disconnection technologies to guarantee optimum safety during all handling operations. They continue to meet with changing requirements of the OEM's in regard to HVIL on a vehicle system and connection system level. Additionally, our ErgoMate™ axial mating system helps achieve a lower profile solution while reducing mating forces. Our solutions offer position assurances in multiple options including: CPA (Connector Position Assurance), TPA (Terminal Position Assurance) and SPA (Screw Position Assurance).

A comprehensive product portfolio

1

High Voltage Auxiliary Modules

APPLICATION:

PTC heater, DC / DC converter, On-Board Charger (OBC), Electric AC, Battery pack, HV PDU

2

High Voltage Power Conversion

HV battery, E-motor, AC / DC inverter, Power electric box, Distribution Unit (HV PDU), DC / DC converter



High Voltage connection systems designed specifically for the voltage and current needs of auxiliary modules, such as PTC heater, DC / DC converter, on-board charger (OBC), electric pack and HV power distribution unit (PDU).

See page **10-31**



High Voltage connection systems designed specifically for the voltage and current needs up to 250A. Power conversion modules consist of inverters, drive motors/generators, and high current/high voltage battery outputs.

See page **32-57**

3

High Voltage 12, 24, 48 Volt Solutions

48V electrical centers, Power distribution boxes, Start-stop systems, E-turbo, Battery, Active suspension, BSG units, High current harness and devices, Sealed pass-through panel mount systems



Growing requirements and a quickly increasing market for 48 Volt applications drive our technology for innovative solutions. Two key characteristics define these solutions: High current carrying capabilities and high sealing protection.

See page **58-63**

4

Charging Solutions

On-vehicle charging inlets, Grid-to-vehicle charging, Charging infrastructure-to-vehicle



With Aptiv products plug-in, hybrid and electric vehicles can be powered safely and efficiently at home or away. Aptiv offers a complete line of all global charging standards: SAE J1772 (North America and Japan), IEC62196 Type II (Europe) and GB/T 20234 (China). In addition, SAE has established a common footprint for DC (Direct Current) fast charging in North America and Europe, better known as Combo 1 and Combo 2.

See page **64-79**

• **APTIV** •

Performance key & Aptiv design indicators key

VOLTAGE

Range: 12V - 1000V

AMPERAGE

Range: 10A - 250A

TEMPERATURE

Class	Ambient Temperature Range
T1	-40°C to +85°C
T2	-40°C to +100°C
T3	-40°C to +125°C
T4	-40°C to +150°C

VIBRATION

Class	Common Name	Typical Application
V1	Chassis Profile	Components on sprung portions of vehicle not coupled to Engine
V2	Engine Profile	Components coupled to Engine with severe vibration possible
V3	Severe On-Engine	Components subject to severe vibration
V4	Extreme Vibration	Used as needed to correlate to extreme vibration areas



• APTIV •

Auxiliary Modules Solutions

SELECTOR GUIDE

APPLICATIONS:

- PTC heater
- DC / DC converter
- On-Board Charger (OBC)
- Electric AC
- Battery pack
- HV PDU







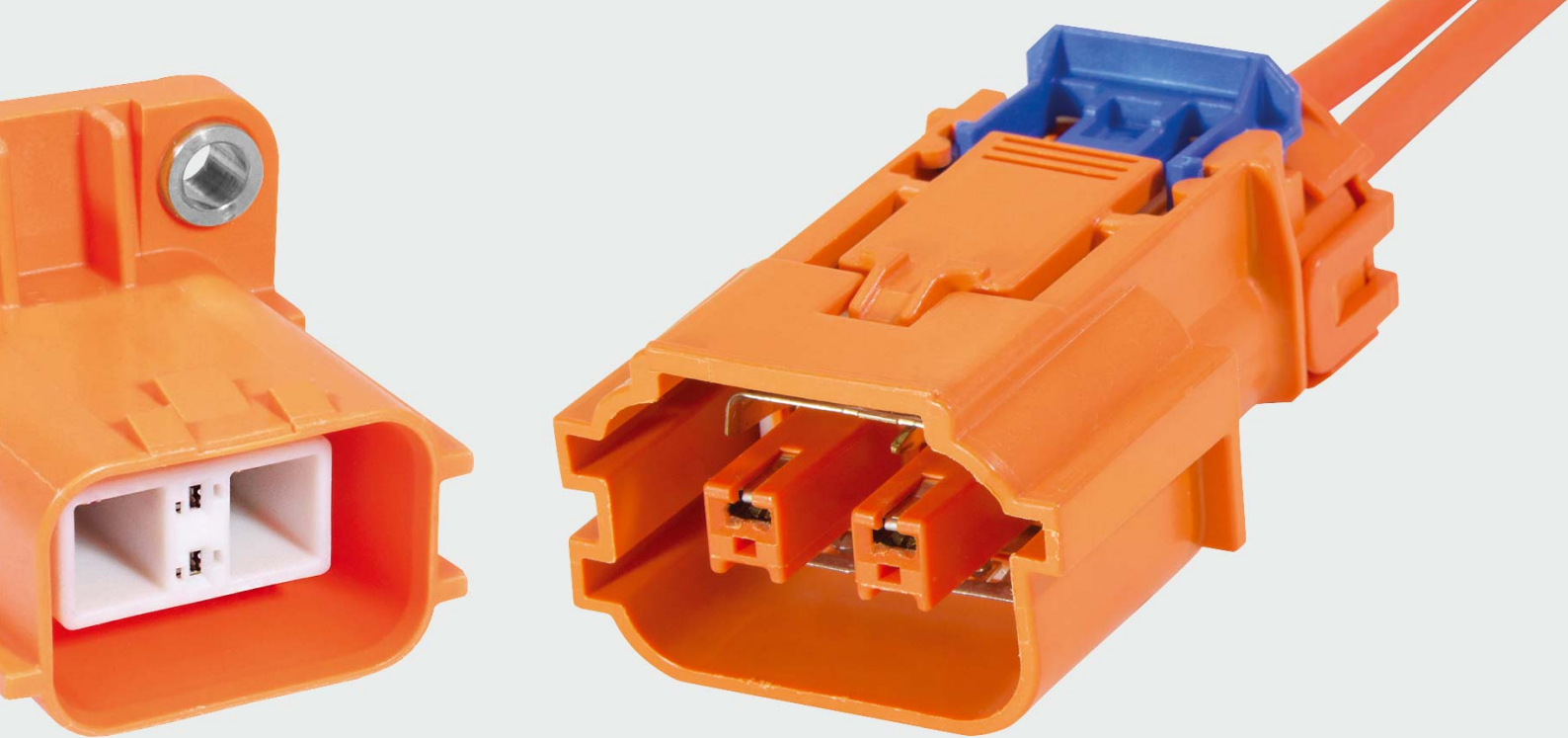

Application	Battery pack, DC / DC converter, On-Board Charger (OBC)			Splicing accessory loads
Product name	SHIELD-PACK™ HV280 2 WAY	SHIELD-PACK™ HV280 3 BAY HEADER*	SHIELD-PACK™ HV280 4 WAY	SHIELD-PACK™ HV280/630 SPLICE
Amperage at 85°C	40 A	40 A	40 A	40 A
Voltage	1000 V	1000 V	1000 V	1000 V
Orientation	90° 180°	180°	180°	180°
# of ways (power)	2	2	4	4
HVIL	✓	✓	✓	✓
Shielding	Individual	Individual	Individual	Individual
Vibration Class	V2	V2	V1	V1
Temperature Class	T3	T3	T3	T3
Sections power	2 - 5 mm ²	2 - 5 mm ²	3 - 5 mm ²	3 - 5 mm ²
Sections HVIL	0.5 mm ²	0.5 mm ²	0.5 - 0.75 mm ²	0.5 - 0.75 mm ²
See Page	12-13	14-15	16-17	18-19

* Please refer to this product for project with space constraints.

** Also compatible for individual cable shielding.



  			  		
Battery pack, DC / DC converter, Electric AC, PTC heater, HV PDU, On-Board Charger (OBC)			On-Board Charger (OBC)		
SHIELD-PACK™ HV630	APEX® HV280	APEX® HV280 DIRECT MATE	SHIELD-PACK™ AK CLASS 1	16 & 32A ON-BOARD CHARGERS	APEX® 950 ON-BOARD CHARGER CONNECTOR
50 A	40 A	40 A	32 A	32 A	125 A
1000 V	1000 V	850 V	1000 V	600 V	750 V
180°	180°	180°	180°	180°	180°
2	2	2	2 & 3	4	4 + 1
×	✓	✓	✓	✓	✓
Individual	Bundle	Bundle**	Multicore	No	No
V2	V1	V2	V2	V1	V3
T3	T3	T3	T4	T3	T3
2 - 6 mm ²	2.5 - 6 mm ²	2.5 - 6 mm ²	2.5 - 4.0 mm ²	3 - 6 mm ²	10 - 16 mm ²
-	0.5 - 0.75 mm ²	0.5 - 0.75 mm ²	0.5 mm ²	0.75 - 1.0 mm ²	0.5 mm ²
20-21	22-23	24-25	26-27	28-29	30-31

SHIELD-PACK™ HV280 2 WAY



2 Way 180° Connection System with Pluggable Inner Connector



2 Way 180° Connection System without Pluggable Inner Connector



2 Way 90° Connection System

APPLICATIONS

- Battery pack

- DC / DC converter

- On-board charger (OBC)

BENEFITS

- Inner connector with TPA can be plugged into header during device assembly (on wire-to-device)
- Industry-leading vibration performance
- Field proven design used across electrification market

FEATURES

- Tool-less unmating system
- Finger proof/touch safe
- Aluminum compression bushings
- ISO cable compatible

AVAILABLE CONFIGURATIONS

Connector Type	Wire-to-device, wire-to-wire
Cable Exit Orientation	90°, 180°
Cable Range (mm ²)	2 - 5 (power) 0.5 (HVIL)
Terminal Type	CTS 2.8, Metri-pack 2.8
# of Power Terminals	2
Shielding Type	Individual
HVIL	Shunt on female
Assembly Assurance	CPA/TPA
Number of Indexes	3 (180°), 1 (90°)

PERFORMANCE

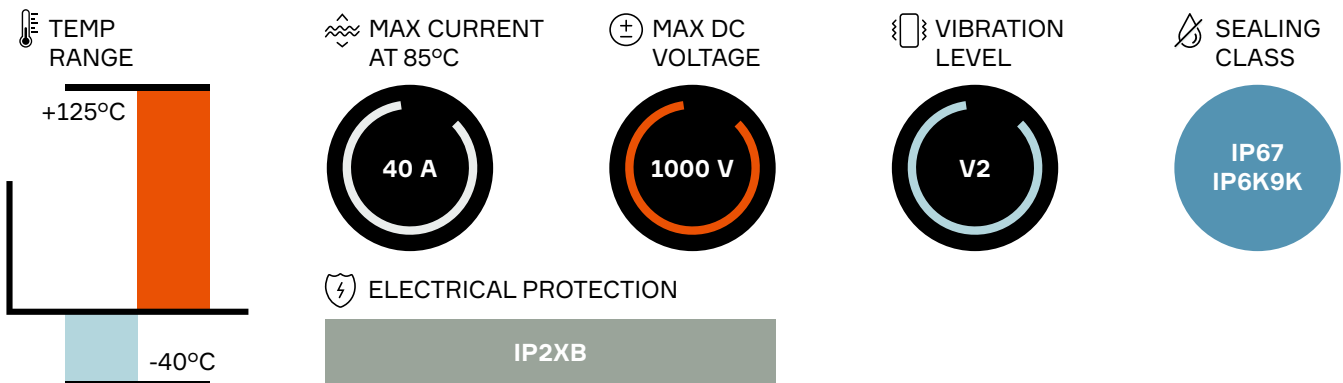

Index	Header with pluggable inner connector		Header	Male inline connector	Mating connector	BOM
	Outer Header	Inner connector				
2 Way 180° Connection System						
101	35201196	15526394	33240508	33358013	33339283	1
102	35201197	15526395	33240509	33358014	33353455	
103	35201198	15526396	33240510	33358015	33353456	
2 Way 90° Connection System						
101	33341078	33341079			33339283	1

ASSOCIATED PARTS

Part number	Description	BOM
Header		
13753470	Metri-pack 2.8 male terminal 1 - 2 mm ²	2
13753471	Metri-pack 2.8 male terminal 3 mm ²	
13790534	Metri-pack 2.8 male terminal 4 - 5 mm ²	
15432235	CTS HVIL female terminal 0.5 mm ²	2
15526390	TPA	1
Inline Male		
13753470	Metri-pack 2.8 male terminal 1 - 2 mm ²	2
13753471	Metri-pack 2.8 male terminal 3 mm ²	
13790534	Metri-pack 2.8 male terminal 4 - 5 mm ²	
13737699	Inner ferrule 3 mm ²	2
33292550	Inner ferrule 5 mm ²	
13737702	Outer ferrule 3 mm ²	2
33292551	Outer ferrule 5 mm ²	
15513453	Cable seal 3 mm ²	1
15513451	Cable seal 5 mm ²	1
13824779	TPA / strain relief 3 mm ²	1
13888072	TPA / strain relief 5 mm ²	1
Mating connector		
13882331	CTS 2.8 female terminal 3 - 5 mm ²	2
13737699	Inner ferrule 3 mm ²	2
33292550	Inner ferrule 5 mm ²	
13737702	Outer ferrule 3 mm ²	2
33292551	Outer ferrule 5 mm ²	
15513453	Cable seal 3 mm ²	1
15513451	Cable seal 5 mm ²	1
13824779	TPA / strain relief 3 mm ²	1
13888072	TPA / strain relief 5 mm ²	1

DIMENSION MEASUREMENT SAMPLE

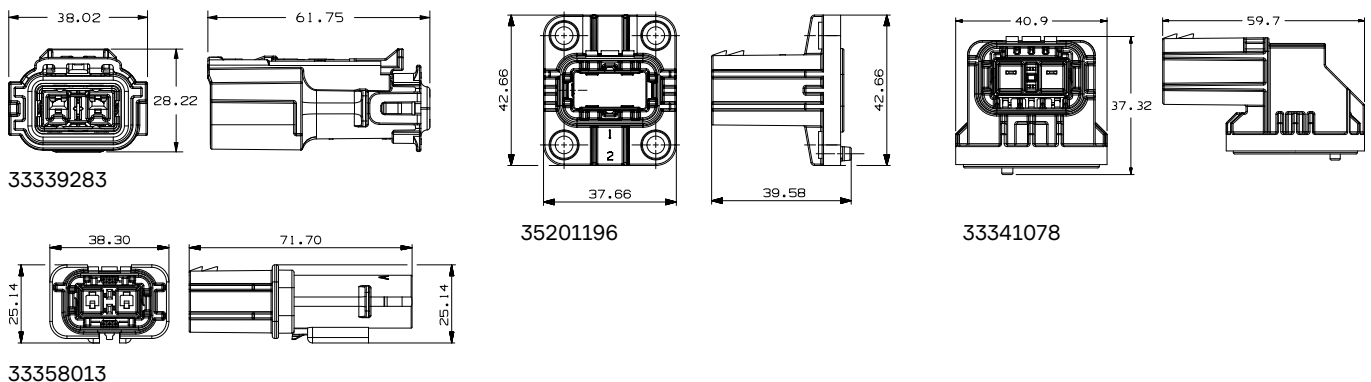

Part numbers, specifications, dimensions and performance data in this document are for general references only and are subject to change without notice. To verify product information, please contact an Aptiv representative.

SHIELD-PACK™ HV280

3 BAY HEADER

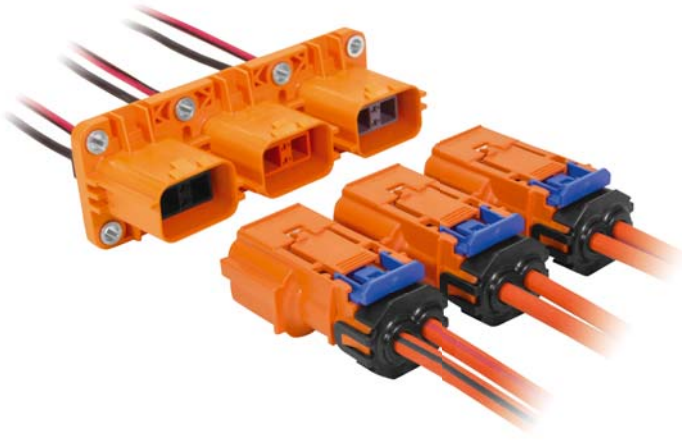

BENEFITS

- Answering to space constraints by having the 3 headers bolted together
- Inner connector with TPA can be plugged into header during device assembly (on wire-to-device)
- Industry-leading vibration performance
- Field proven design used across electrification market

FEATURES

- Tool-less unmatting system
- Finger proof/touch safe
- Aluminum compression bushings
- ISO cable compatible

APPLICATIONS

Battery pack

DC / DC converter

On-board charger (OBC)

AVAILABLE CONFIGURATIONS

Connector Type	Wire-to-device
Cable Exit Orientation	180°
Cable Range (mm ²)	2 - 5 (power) 0.5 (HVIL)
Terminal Type	CTS 1.2, Metri-pack 2.8
# of Power Terminals	2
Shielding Type	Individual
HVIL	Shunt on female
Assembly Assurance	CPA/TPA
Number of Indexes	3

PERFORMANCE

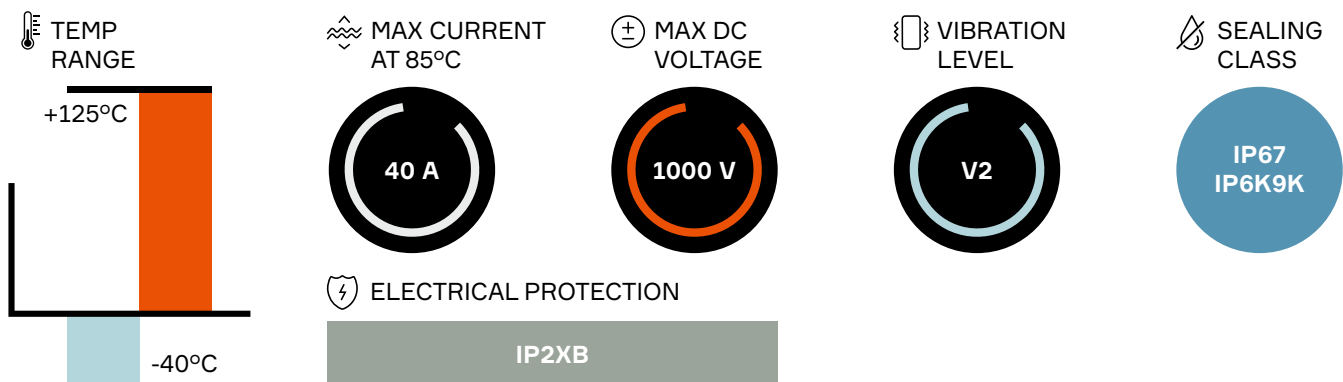

Index	Header outer	Header inner connector	Mating connector	BOM
103	33223976	15526396	33353456	1
104		15526397	33353457	
105		33137225	33353458	

ASSOCIATED PARTS

Part number	Description	BOM
Header		
13753470	Metri-pack 2.8 male terminal 1 - 2 mm ²	2
13753471	Metri-pack 2.8 male terminal 3 mm ²	
13790534	Metri-pack 2.8 male terminal 4 - 5 mm ²	
15432235	CTS HVIL female terminal 0.5 mm ²	2
15526390	TPA	1
Mating connector		
13882331	CTS 2.8 female terminal 3 - 5 mm ²	2
13737699	Inner ferrule 3 mm ²	2
33292550	Inner ferrule 5 mm ²	
13737702	Outer ferrule 3 mm ²	2
33292551	Outer ferrule 5 mm ²	
15513453	Cable seal 3 mm ²	1
15513451	Cable seal 5 mm ²	1
13824779	TPA / strain relief 3 mm ²	1
13888072	TPA / strain relief 5 mm ²	1

DIMENSION MEASUREMENT SAMPLE

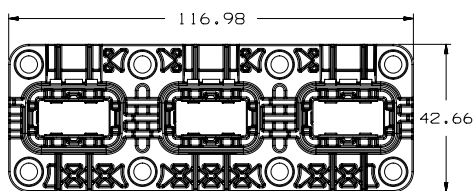

33223976

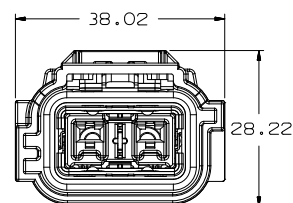
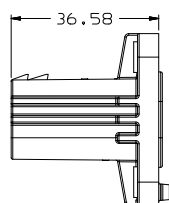

33353456

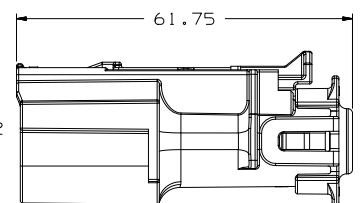

SHIELD-PACK™ HV280 4 WAY



BENEFITS

- No mechanical assist needed for mating
- Compact system design with integrated HVIL
- Robust error-proof assembly and system mating

FEATURES

- Tool-less unmating system
- Finger proof/touch safe
- 4 power circuits
- Panel mount to device with face seal (on wire-to-device)
- Aluminum compression bushings
- Internal HVIL (shunted in harness connector)
- ISO cable compatible

APPLICATIONS

- Battery pack
- DC / DC converter
- On-board charger (OBC)

AVAILABLE CONFIGURATIONS

Connector Type	Wire-to-device
Cable Exit Orientation	180°
Cable Range (mm ²)	3 - 5 (power) 0.5 - 0.75 mm (HVIL)
Terminal Type	CTS 2.8
# of Power Terminals	4
Shielding	Individual
HVIL	Shunt on female
Assembly Assurance	CPA
Number of Indexes	2

PERFORMANCE

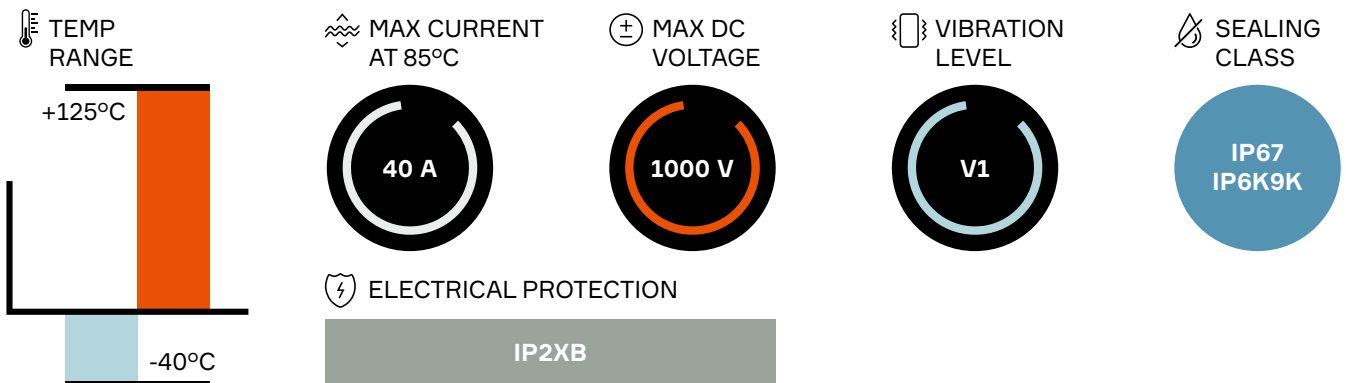

Index	Header outer	Header inner connector	Mating connector	BOM
101	35099959	35099976	33314147	1
102	35161787	35149737	33314148	

ASSOCIATED PARTS

Part number	Description	BOM
Header		
13597855	MTS 0.64 HVIL female terminal 0.5 - 0.75 mm	2
13753471	CTS 2.8 male terminal 3 - 5 mm ²	4
13790534	CTS 2.8 male terminal 4 - 5 mm ²	
33314145	TPA (Terminal Position Assurance)	2
Mating Connector		
13882331	CTS 2.8 female terminal 3 - 5 mm ²	4
13737699	Inner ferrule 3 mm ² ISO cable	4
33292550	Inner ferrule 5 mm ² ISO cable	
13737702	Outer ferrule 3 mm ² ISO cable	4
33292551	Outer ferrule 5 mm ² ISO cable	
35072736	3 mm ² ISO cable seal	1
35072735	5 mm ² ISO cable seal	
35072739	3 mm ² ISO cable seal cover	1
35072738	5 mm ² ISO cable seal cover	

DIMENSION MEASUREMENT SAMPLE

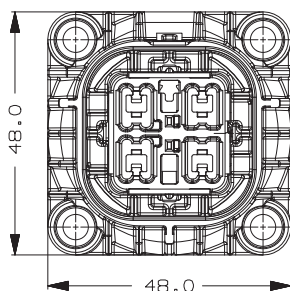

35099959

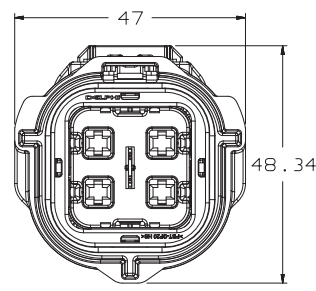
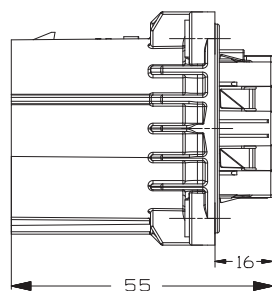

33314147

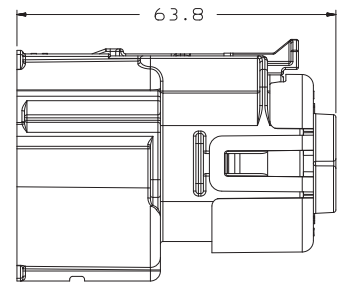

SHIELD-PACK™ HV280/630 SPLICE

BENEFITS

- Removes splices from the wiring harness and integrates splicing capabilities into connector
- No mechanical assist needed for mating

FEATURES

- Tool-less unmating system
- Finger proof/touch safe
- Panel mount to device with face seal
- Aluminum compression bushings
- Internal HVIL (shunted in harness connector)
- ISO cable compatible

APPLICATIONS

Splicing accessory loads

AVAILABLE CONFIGURATIONS

Connector Type	Wire-to-device
Cable Exit Orientation	180°
Cable Range (mm ²)	3 - 5 (power) 0.5 - 0.75 (HVIL)
Terminal type	CTS 2.8(2) / 6.3(2)
# of Power Terminals	4
Shielding	Individual
HVIL	Shunt on female
Assembly Assurance	CPA
Number of Indexes	2

PERFORMANCE

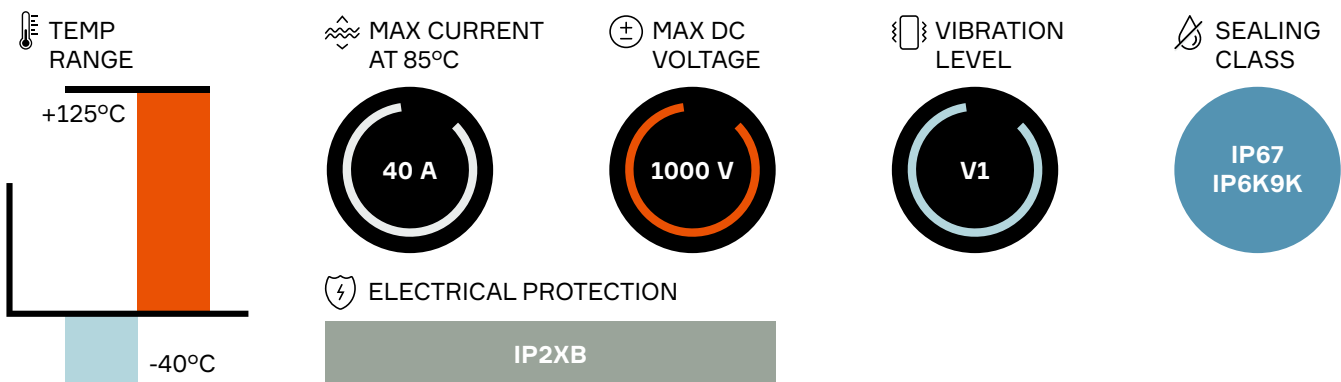

Index	Header outer	Header inner connector	Mating connector	BOM
101	33300632	33311166	33300634	1
102	33300633	33311167	33300635	

ASSOCIATED PARTS

Part number	Description	BOM
Header		
13597855	MTS 0.64 HVIL female terminal 0.5 - 0.75 mm	2
33299800	630/280 male terminal 3 - 5 mm ²	2
33299799	TPA (Terminal Position Assurance)	2
Mating Connector		
13882331	CTS 2.8 female terminal 3 - 5 mm ²	2
13984302	CTS 6.3 female terminal 2.5 - 4 mm ²	2
13984307	CTS 6.3 female terminal 4 - 6 mm ²	
13737699	Inner ferrule 3 mm ² ISO cable	4
33292550	Inner ferrule 5 mm ² ISO cable	
13737702	Outer ferrule 3 mm ² ISO cable	4
33292551	Outer ferrule 5 mm ² ISO cable	
35072736	3 mm ² ISO cable seal	1
35072735	5 mm ² ISO cable seal	
35072739	3 mm ² ISO cable seal cover	1
35072738	5 mm ² ISO cable seal cover	

APPLICATION GUIDE

Power circuits shown, two sets of 2 in x 1 out

Application Guide for Aptiv 4W CTS 630/280 Shielded Connection
Typical Application – * Load Current Guidance



Terminal crimp wings are shown un-crimped.

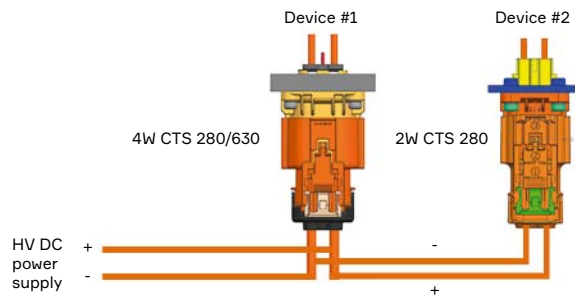

*** Typical steady state currents with 5 mm² cable on all circuits**

Input from DC power supply: 40 - 45 A
 Current to Device #1: ≤ 40 A
 Current to Device #2: ≤ 30 A

** Connector current ratings in vehicle applications will be affected by multiple factors including device heating, harness coverings, and device duty cycles. Please review application details with Aptiv Product Engineering for verification of current carrying capability.*

DIMENSION MEASUREMENT SAMPLE

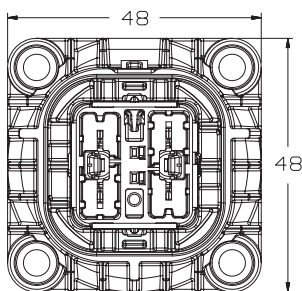

33300632

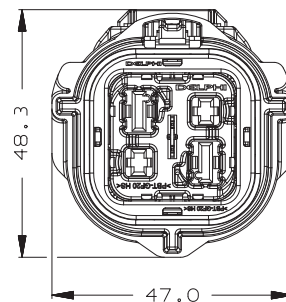
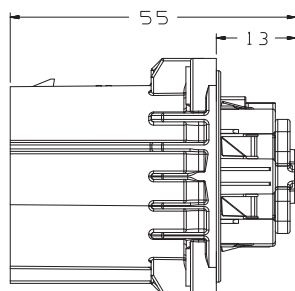

33300634

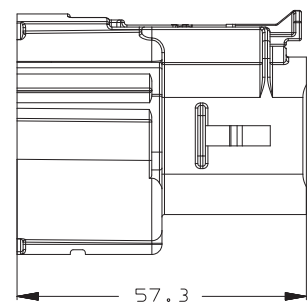

Part numbers, specifications, dimensions and performance data in this document are for general references only and are subject to change without notice. To verify product information, please contact an Aptiv representative.



SHIELD-PACK™ HV630



HV630 Header and Mating connector*

BENEFITS

- Inner connector with TPA can be plugged into header during device assembly (on wire-to-device)
- Industry's most compact 630 2 way system
- Industry leading vibration performance
- External header housing is the same for the HV280 and HV630

FEATURES

- Tool-less unmating system
- Finger proof/touch safe
- Panel mount to device with face seal (on wire-to-device)
- Aluminum compression bushings
- ISO cable compatible
- Secondary terminal locking

APPLICATIONS

Battery pack

DC / DC converter

On-board charger (OBC)

AVAILABLE CONFIGURATIONS

Connector Type	Wire-to-device, wire-to-wire
Cable Exit Orientation	180°
Cable Range (mm ²)	3 - 6 (power)
Terminal Type	CTS 6.3
# of Power Terminals	2
Shielding Type	Individual
HVIL	None
Assembly Assurance	TPA (wire-to-device) CPA (wire-to-wire)
Number of Indexes	3 (wire-to-device) 3 (wire-to-wire)

* Mating connector is most commonly available with the natural beige color

PERFORMANCE

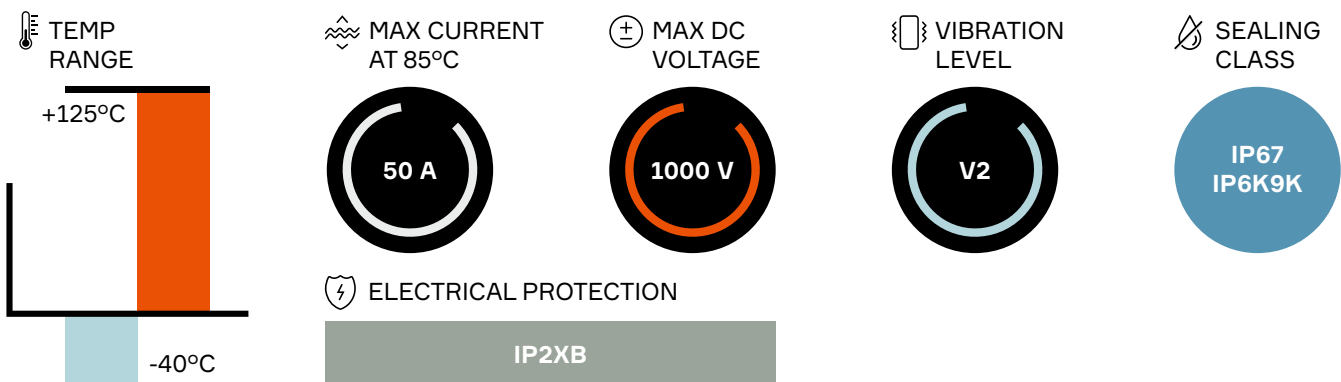

Index	Header outer	Header inner connector	Inline connector	Mating connector	BOM
101	35201196	35028833	35201706	35028839	1
102	35201197	35028834	35201707	35028840	
103	35201198	35028835	35201708	35028841	

ASSOCIATED PARTS

Part number	Description	BOM
Header		
33375907	2.4 - 3.4 cable OD 3 - 6 mm ²	2
35028830	TPA (Terminal Position Assurance)	1
Inline connector		
35063063	4.8 male terminal	2
Mating connector		
13737699	Inner ferrule 3 mm ² cable	2
13737700	Inner ferrule 4 mm ² cable	
33292550	Inner ferrule 5 mm ² & 6 mm ² cable	
13737702	Outer ferrule 3 mm ² & 4 mm ² cable	2
33292551	Outer ferrule 5 mm ² & 6 mm ² cable	
13824779	Seal retainers 3 mm ² & 4 mm ² cable	1
13888072	Seal retainers 5 mm ² & 6 mm ² cable	
15513453	Cable seal 3 mm ² cable	1
15513452	Cable seal 4 mm ² cable	
15513451	Cable seal 5 mm ² & 6 mm ² cable	

DIMENSION MEASUREMENT SAMPLE

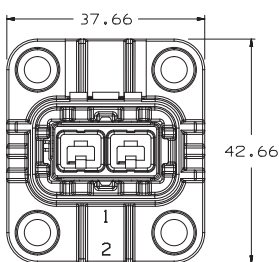

35201196

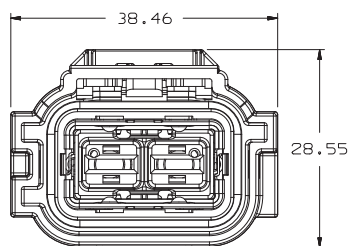
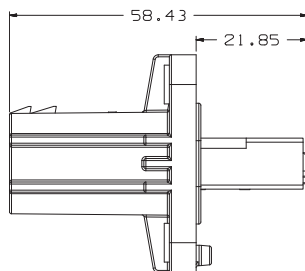

35028839

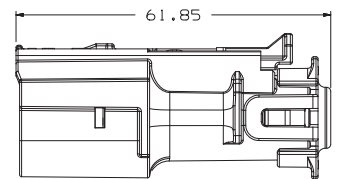

APEX[®] HV280

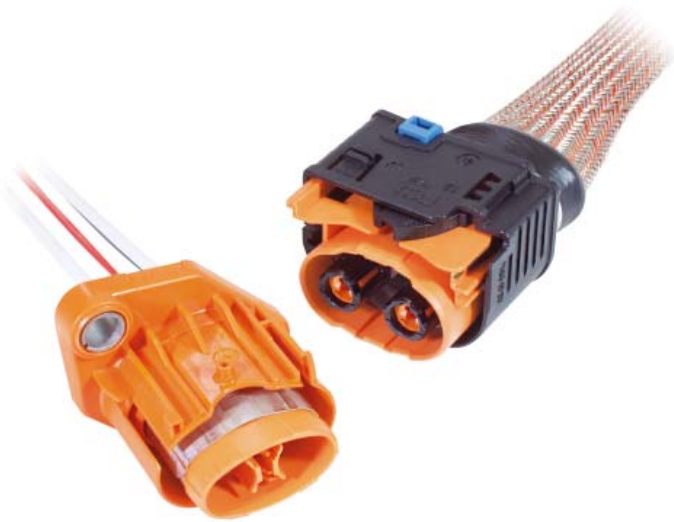

BENEFITS

- Two-stage disconnect for safe unmating
- Compact package with unique integrated electric interlock
- Header is sealed in both mated and unmated position

FEATURES

- Bundle shielding with external braid
- HVIL shunted in harness connector

APPLICATIONS

Battery pack
DC / DC converter
On-board charger (OBC)

AVAILABLE CONFIGURATIONS

Connector Type	Wire-to-device
Cable Exit Orientation	180°
Cable Range (mm ²)	2.5 - 6 (power) 0.5 - 0.75 (HVIL)
Terminal Type	Apex [®] 2.8
# of Power Terminals	2
Shielding	Bundle
HVIL	Shunt on female
Assembly Assurance	CPA
Number of Indexes	2

PERFORMANCE

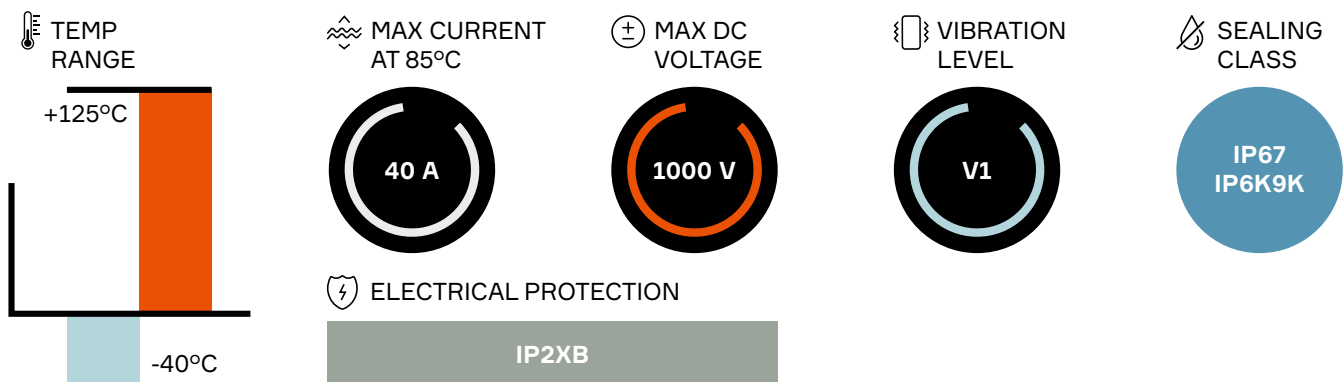

Index	Header connector	Mating connector	BOM
101	33511766	33517428	1
102	33511767	33511765	

ASSOCIATED PARTS

Part number	Description	BOM
Header		
15509074	APEX® 2.8 male terminal 2.5 mm ²	2
15516298	APEX® 2.8 male terminal 4 - 6 mm ²	
33511802	DCS2 1.5 male terminal gold-plated 0.22 - 0.35 mm ²	2
10779703	DCS2 1.5 male terminal gold-plated 0.5 - 1.0 mm ²	
Mating connector		
13627267	APEX® 2.5 mm ²	2
10810733	APEX® 4 - 6 mm ²	
Seals		
33512180	Header and mating: APEX® 2.8 female & male single wire seal 2.5 mm ²	2
33512175	Header and mating: APEX® 2.8 female & male single wire seal red 4 mm ²	
35289308	Header and mating: APEX® 2.8 female & male single wire seal 6 mm ²	
15441379	Header: DCS/DSQ 1.5 red single wire seal 0.22 - 0.5 mm ²	2
15441380	Header: DCS/DSQ 1.5 grey single wire seal 0.75 - 1.0 mm ²	

DIMENSION MEASUREMENT SAMPLE

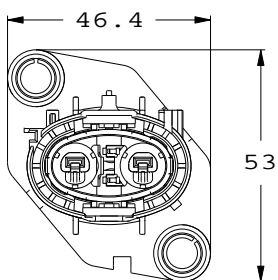

33511766

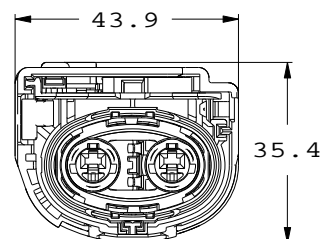
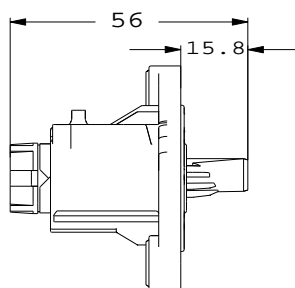

33517428

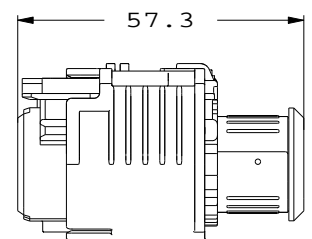

APEX[®] HV280 DIRECT MATE

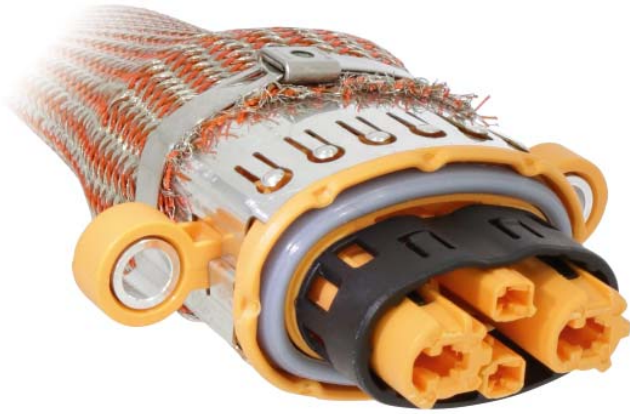

BENEFITS

- Same connector for both bundle and individual cable shielding
- Cost effective solution thanks to the direct connection between the female connector and the male terminals within the device case
- High EMC & RFI shielding performance with direct connection to metal device case

FEATURES

- Two HV power circuits (APEX[®] 2.8 mm terminal)
- Bundle shielding with external braid in serial production
- Individual cable shielding version available by request
- Integrated HVIL (HV interlock line)

APPLICATIONS

Battery pack

DC / DC converter

On-board charger (OBC)

AVAILABLE CONFIGURATIONS

Connector Type	Wire-to-device
Cable Exit Orientation	180°
Cable Range (mm ²)	2.5 - 6 (power) 0.5 - 0.75 (HVIL)
Terminal Type	APEX [®] 2.8
# of Power Terminals	2
Shielding	Bundle (also compatible for individual cable shielding)
HVIL	Pass-through or shunt on header
Assembly Assurance	None (screwed)
Number of Indexes	1

PERFORMANCE

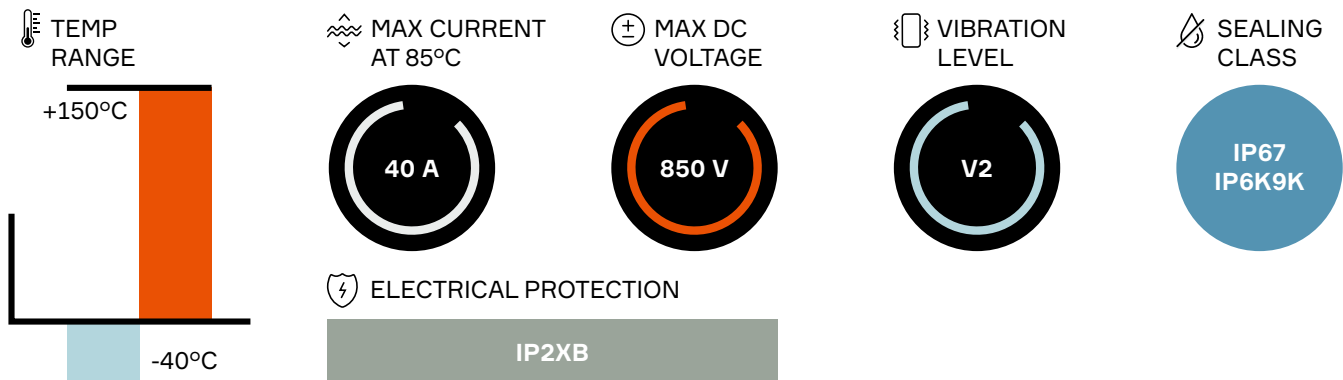

Header connector	Mating connector	BOM
Not needed (mates directly to device)	35208936	1

ASSOCIATED PARTS

Part number	Description	BOM
Mating connector		
15509074	APEX® 2.8 female terminal 2.5 mm ²	2
15516298	APEX® 2.8 female terminal 4 - 6 mm ²	
13834764	Single wire seal 3.4 - 4.4 mm	2
35206690	Cable strain relief	2
15549847	DSQ 1.5 female terminal silver-plated 0.35 - 0.5 mm ²	2
15549848	DSQ 1.5 female terminal silver-plated 0.75 - 1.0 mm ²	
15441379	DCS 1.5 red single wire seal 0.35 - 0.5 mm ²	2
15441380	DCS 1.5 grey single wire seal 0.75 - 1 mm ²	

DIMENSION MEASUREMENT SAMPLE

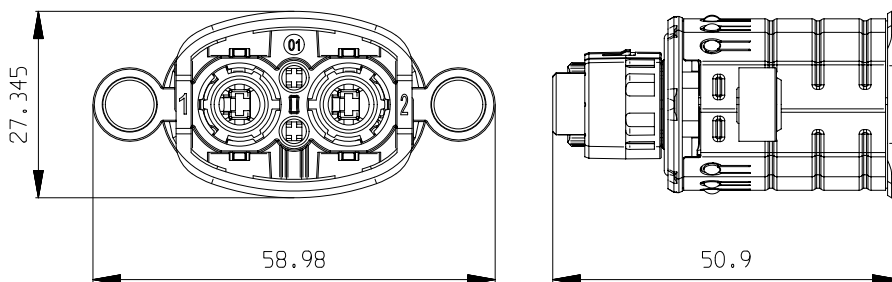

35208936

SHIELD-PACK™ AK CLASS 1 AK



BENEFITS

- Standard AK interface
- High vibrations and operating temperatures
- Multiple layouts & HVIL options in the same interface

FEATURES

- Designed according to AK interface specification and LV215 latest revision
- Finger proof/touch safe
- Multicore shielded cable for wiring simplification
- Fully interchangeable with other AK supplier sources

APPLICATIONS

Battery pack

DC / DC converter

Electric AC

PTC heater

HV PDU

On-board charger (OBC)

AVAILABLE CONFIGURATIONS

Connector Type	Wire-to-device
Cable Exit Orientation	180°
Cable Range (mm ²)	2.5 - 4.0 (power) 0.5 - 0.75 (HVIL)
Terminal Type (mm)	2.8
# of Power Terminals	2
Shielding	Multicore
HVIL	Shunt on female or inline
Assembly Assurance	CPA/TPA
Number of Indexes	5

PERFORMANCE

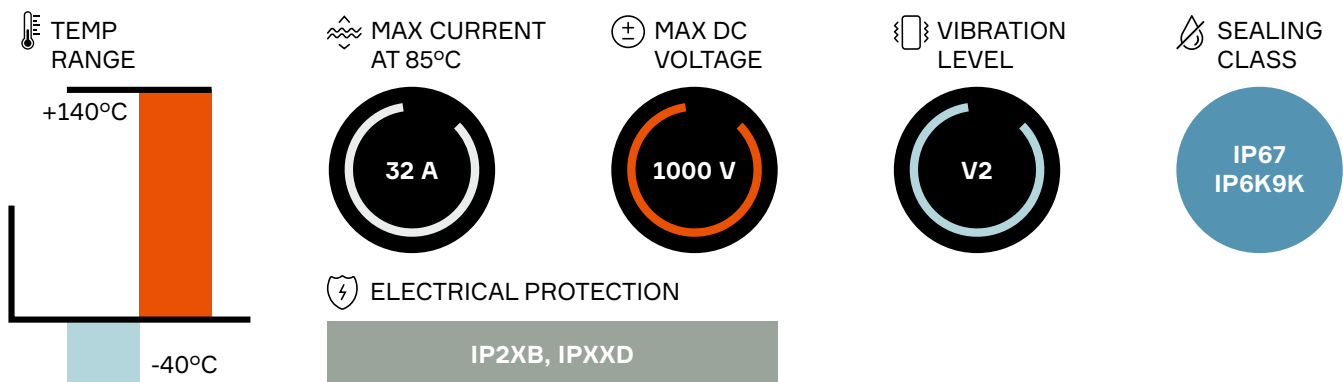

Code	Header 2 way	Header 3 way	Mating outer housing	BOM
A	35149836	35149842	33372017	1
B	35149837	35149843	33372014	
C	35149838	35149844	33372016	
D	35149839	35149845	33372015	
E	35149840	35149846	35061103	

ASSOCIATED PARTS

Part number	Description	BOM		
		2 way, HVIL pass-through	2 way, HVIL shunt	3 way
Header				
35194900	DCS-2 2.8 male terminal 2.5-4 mm ² Ag	2	2	3
35149868	HVIL terminal 0.5 - 0.75	2	2	-
35149869	TPA (Terminal Position Assurance)	1	1	-
15540356	TPA (Terminal Position Assurance)	-	-	1
Mating Connector				
33514302	DCK 2.8 female terminal 2.5 mm ² Ag	2	2	3
33522728	DCK 2.8 female terminal 4 mm ² Ag or*			
13799603	CTS 2.8 female terminal 2.5 mm ² Ag	2	2	-
13882331	CTS 2.8 female terminal 4 mm ² Ag			
33504709	Male duo twin 0.64 0.5 mm ²	1	1	1
35174268	Spacer	2	2	2
35174446	Shielding	-	-	1
35174249	Cable strain relief 3 x 2.5 mm ²	-	-	1
35174250	Cable seal 3 x 2.5 mm ²	-	-	1
35174511	Inner housing 2 way	1	-	-
35174507	Cable strain relief 2 x 4.0 mm ²	-	1	-
35174508	Cable seal 2 x 4.0 mm ²	1	1	-
35174280	Inner ferrule	1	1	1
35174278	Outer ferrule	1	1	1
35174509	Inner housing sub-assembly	-	1	-
35174448	Inner housing 3 way	-	-	1
35174513	TPA (Terminal Position Assurance)	1	-	-
35174510	Cable strain relief 2 x 4.0 + 2 x 0.5 mm ²	1	-	-

* Both DCK terminals and CTS terminals are compatible.

Component Kits**

Part number	Description (pass-through version)	Part number	Description (shunted version)
35122237	2 x 4 mm ² + 2 x 0.5 mm ² cable code A	33367712	2 x 4 mm ² cable code A
35122238	2 x 4 mm ² + 2 x 0.5 mm ² cable code B	35122240	2 x 4 mm ² cable code B
33367711	2 x 4 mm ² + 2 x 0.5 mm ² cable code C	35122241	2 x 4 mm ² cable code C
35122239	2 x 4 mm ² + 2 x 0.5 mm ² cable code D	33367710	2 x 4 mm ² cable code D
35086591	2 x 4 mm ² + 2 x 0.5 mm ² cable code E	35086590	2 x 4 mm ² cable code E

** Available configurations with associated BOM (Bill Of Materials).

DIMENSION MEASUREMENT SAMPLE

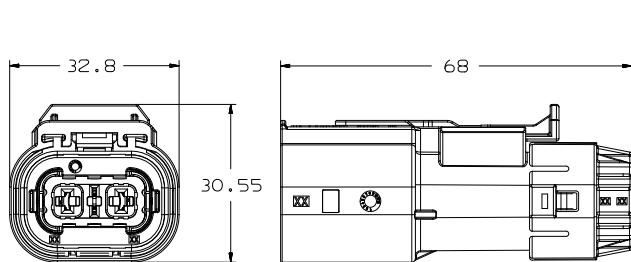

33367712

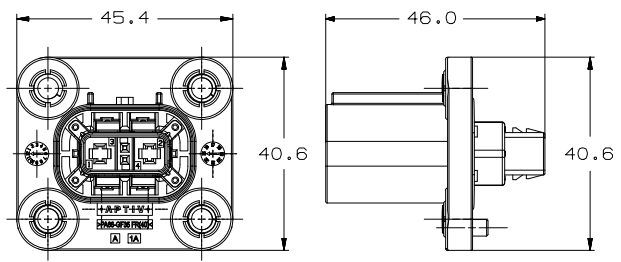

35149836

Part numbers, specifications, dimensions and performance data in this document are for general references only and are subject to change without notice. To verify product information, please contact an Aptiv representative.



16 & 32A ON-BOARD CHARGERS

BENEFITS

- Field proven technology widely used across electrification market
- Configurable for both 1-phase and 3-phase applications
- Compact packaging

FEATURES

- Finger proof/touch safe
- Capability for 4 power circuits and 2 signal circuits
- Unshielded system with terminal spacing for HV applications
- One-stage locking system with CPA
- Aluminum compression bushings

APPLICATIONS

On-board charger (OBC)

AVAILABLE CONFIGURATIONS

Connector Type	Wire-to-device, wire-to-wire
Cable Exit Orientation	180°
Cable Range (mm ²)	3 - 5 (power) 0.75 - 1.0 (HVIL)
Terminal Type	HES 1.0 (signal) HES 2.4 (power)
# of Power Terminals	4 (2 signal terminals)
Shielding Type	Unshielded
HVIL	None
Assembly Assurance	CPA
Number of Indexes	2

PERFORMANCE

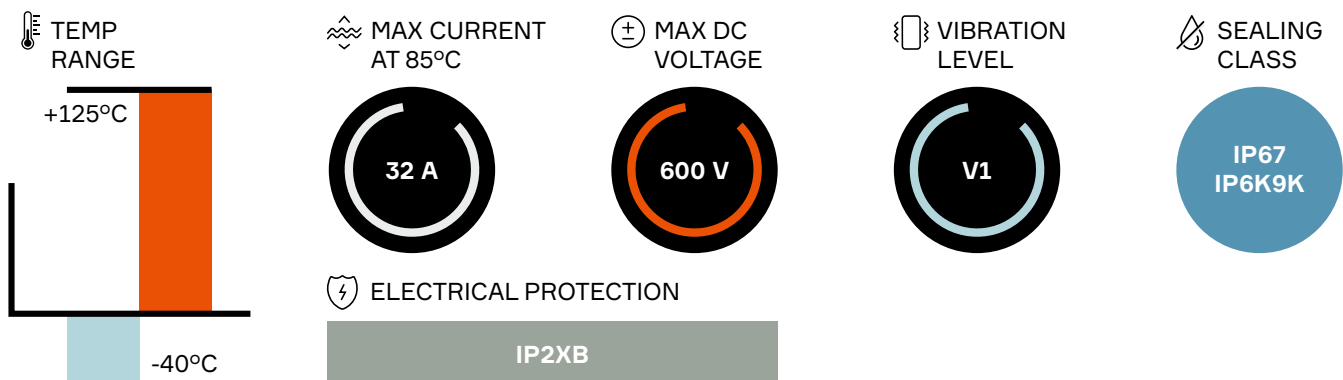

6 Way Device Connection System

Header connector	Mating connector		BOM
	16A	32A	
33229378	13879051 (2+2)	13879048 (2+2)	1
	15525754 (3+0)	15525753 (3+0)	
	13879050 (3+2)	13879047 (3+2)	
	13879049 (4+2)	13879046 (4+2)	

6 Way Inline Connection System

Male inline 16A	Male inline 32A	Mating connector	
		16A	32A
13990593 (2+2)	13990590 (2+2)	13879051 (2+2)	13879048 (2+2)
13990591 (4+2)	13990588 (4+2)	13879049 (4+2)	13879046 (4+2)

ASSOCIATED PARTS

Part number	Description	BOM
Header / Male inline		
13663724	1.0 HES gold-plated 0.75 - 1.0 mm ²	2 or 4
13783283	2.4 HES gold-plated 2 - 3 mm ²	2, 3, or 4
13783284	2.4 HES gold-plated 4 - 5 mm ²	
Mating connector		
13663728	1.0 HES gold-plated 0.75 - 1.0 mm ²	2 or 4
13783300	2.4 HES gold-plated 2 - 3 mm ²	2, 3, or 4
13783301	2.4 HES gold-plated 4 - 5 mm ²	

DIMENSION MEASUREMENT SAMPLE

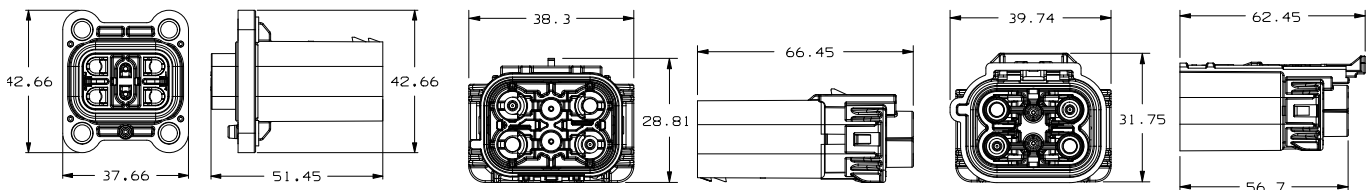

33229378

13990590

13879048*

* Female connector is compatible with both device & inline male connectors.

Part numbers, specifications, dimensions and performance data in this document are for general references only and are subject to change without notice. To verify product information, please contact an Aptiv representative.



APEX[®] 950 ON-BOARD CHARGER CONNECTOR



BENEFITS

- Header is sealed in mated or unmated position
- Unshielded 4 + 1 way to connector designed for on-board chargers up to 125A 3-phase
- Panel mount to device with face seal to module

FEATURES

- Unique integrated electric interlock
- HVIL shunted in harness connector
- ErgoMate™ slider for easy handling and reduced mating force

APPLICATIONS

On-board charger (OBC)

AVAILABLE CONFIGURATIONS

Connector Type	Wire-to-device
Cable Exit Orientation	180°
Cable Range (mm ²)	10 - 16 (power) 0.5 (HVIL)
Terminal Type	9.5
# of Terminals	4 (9.5) + 1 (2.8)
Shielding Type	Unshielded
HVIL	Shunt on female
Assembly Assurance	CPA
Number of Indexes	1

PERFORMANCE

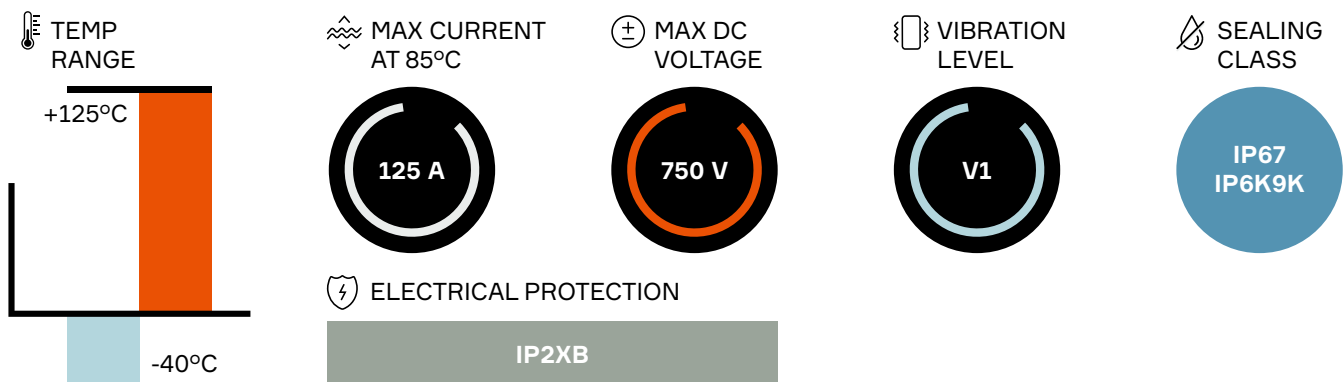

Header connector	Mating connector	BOM
33402137	33402139	1

ASSOCIATED PARTS

Part number	Description	BOM
Header		
33514386	APEX® 950 10 - 16 mm ²	4
15516298	APEX® 2.8 4 mm ²	1
10779703	DCS2 1.5 male terminal gold-plated 0.5 - 1.0 mm ²	2
Mating connector		
33514387	APEX® 950 10 - 16 mm ²	4
10810733	APEX® 2.8 4 mm ²	1
Seals		
33503295	Header and mating: APEX® 950 yellow single wire seal 16 mm ²	4
33503294	Header and mating: APEX® 950 blue single wire seal 10 mm ²	
33512175	Header and mating: APEX® 2.8 red single wire seal 4 mm ²	1
15441379	Header and mating: APEX® DCS 1.5 red single wire seal 0.22 - 0.5 mm ²	2

DIMENSION MEASUREMENT SAMPLE

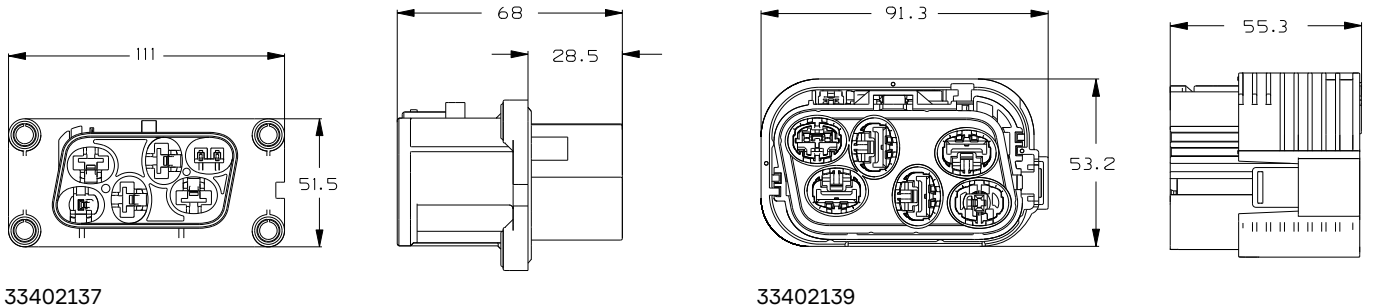

Part numbers, specifications, dimensions and performance data in this document are for general references only and are subject to change without notice. To verify product information, please contact an Aptiv representative.

Power Conversion

SELECTOR GUIDE

APPLICATIONS:

- HV battery
- E-motor
- AC / DC inverter
- Power electric box
- Distribution Unit (HV PDU)
- DC / DC converter

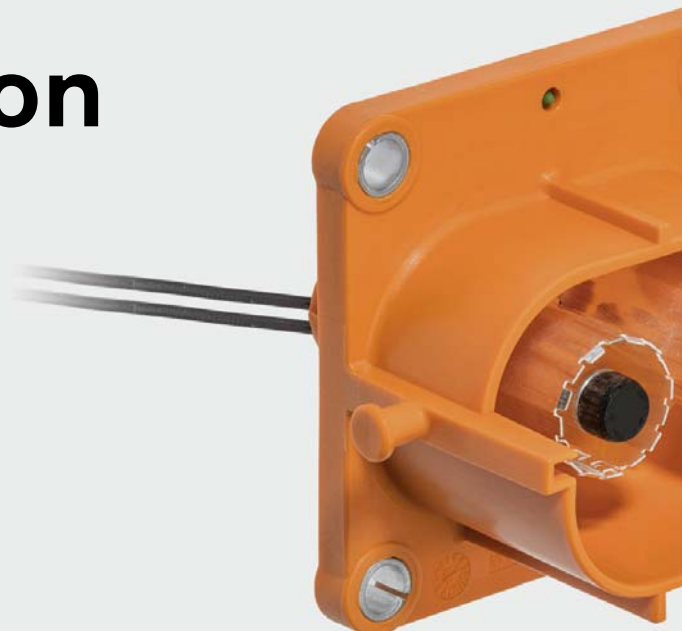







Application	AC / DC inverter, DC / DC converter, HV battery, Power electric box, HV PDU			E-motor, AC / DC inverter, Power electric box, HV PDU	
Description	SHIELD-PACK™ AK CLASS 4	HV RCS 890 SW SERIES	HV RCS 800 SERIES	HV RCS 890 SERIES	HV RCS 890 RV 2 WAY SERIES
Amperage at 85°C	245 A	210 A	210 A	200 A	200 A
Voltage	1000 V	600 V	1000 V	1000 V	1000 V
Orientation	90° 180°	90°	180°	90°	90°
# of ways (power)	2	2	2	2	2
HVIL	✓	✓	✓	✓	✓
Shielding	Individual	Individual	Bundle	Bundle	Bundle
Vibration Class	V2	V1*	V1	V1	V1
Temperature Class	T4	T3	T3	T3	T3
Sections power	25 - 50 mm ²	35 - 70 mm ²	35 - 50 mm ²	35 - 50 mm ²	16 - 70 mm ²
Sections HVIL	0.5 mm ²	0.35 - 1.0 mm ²	0.5 - 0.75 mm ²	0.5 - 0.75 mm ²	0.5 - 0.75 mm ²
See Page	34-35	36-37	38-39	40-41	42-43

* For classification V2 please consult an Aptiv representative.

** For solution with HVIL please contact your local Aptiv representativ.



						
AC / DC inverter, DC / DC converter, HV battery, Power electric box, HV PDU				AC / DC inverter, HV battery, HV PDU, Power electric box, E-motor		
HV RCS 890 RV 3 WAY SERIES	HV RCS 800 DIRECT MATE 1 WAY	HV RCS 800 DIRECT MATE 2 WAY	HV RCS 890 DIRECT MATE 2 WAY	SHIELD-PACK™ HV2000	HV AK PASS-THROUGH	HV METAL PASS-THROUGH
200 A	210 A	210 A	200 A	250 A	N/A	N/A
1000 V	850 V	850 V	850 V	1000 V	600 V (AC) 1000 V (DC)	600 V (AC) 1000 V (DC)
90°	180°	180°	90°	90°	180°	180°
3	1	2	2	2	1, 2 & 3	1
✓	×	×**	✓	✓	×	×
Bundle	Unshielded	Individual	Individual	Individual	Individual	Individual
V1	V1*	V1*	V1*	V3	V4	V3
T3	T3	T3	T3	T3	T4	T3
16 - 70 mm ²	35 - 50 mm ²	35 - 50 mm ²	35 - 50 mm ²	35 - 50 mm ²	16 - 50 mm ²	25 - 50 mm ²
0.5 - 0.75 mm ²	–	–	0.35 - 1.0 mm ²	0.5 mm ²	–	–
44-45	46-47	48-49	50-51	52-53	54-55	56-57

SHIELD-PACK™ AK CLASS 4 AK



BENEFITS

- Standard AK interface
- High robustness against vibrations
- Higher operating temperatures

FEATURES

- Header compatible with both straight & right angle female connector
- Connector and header design according to AK interface specification and LV215 latest revision
- Individual shielded cables
- Fully compatible with other AK supplier sources

APPLICATIONS

AC / DC inverter
 HV battery
 HV PDU
 E-motor
 Power electric box

AVAILABLE CONFIGURATIONS

Connector Type	Wire-to-device
Cable Exit Orientation	90°, 180°
Cable Range (mm ²)	25 - 50 (power) 0.5 (HVIL)
Terminal Type	8 mm round contact system
# of Power Terminals	2
Shielding	Individual
HVIL	Shunt on female
Assembly Assurance	CPA/TPA
Number of Indexes	4

PERFORMANCE

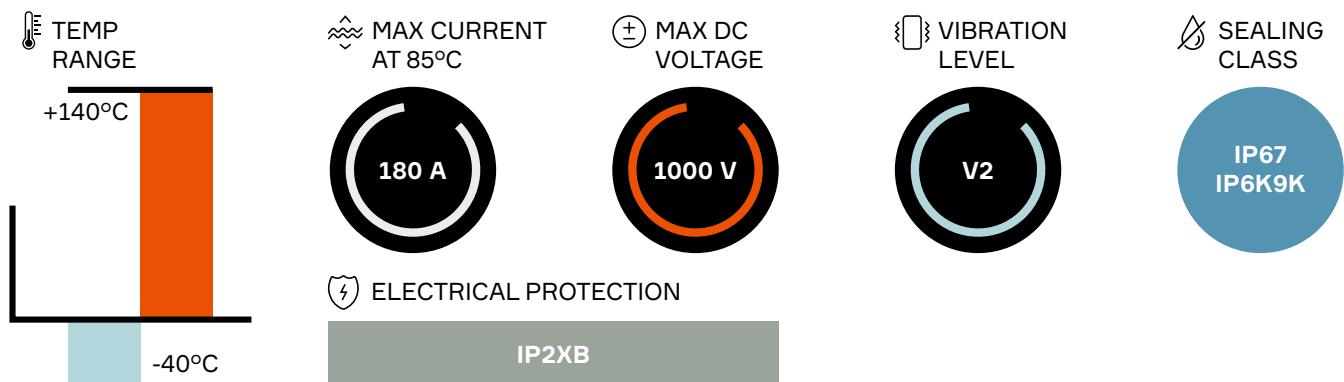

Code	Header UL HB	Header UL VO	2 way mating outer housing	BOM
A	35166503	33351454	33355781	1
B	35166504	33351455	33355782	
C	35166505	-	33355783	
D	35166506	-	33355784	

ASSOCIATED PARTS

Description	Cable size			BOM*
	25 mm ²	35 mm ²	50 mm ²	
Outer insulation	35172730			2
Active female terminal	35172744			2
Crimp female terminal	35172741	35172742		2
Inner ferrule	35172724	35172725	35172726	2
Outer ferrule - Ni plated	35172727	35172728	35172729	2
Cable strain relief	35172735	35172736	35172737	2
Cable seal	35172732	35172733	35172734	2
HVIL 1.2 male terminal MCON* 0.5 mm ²	13954415			3
HVIL 1.2 male terminal MCON* 0.75 mm ²	13952636			3

* Reference refers to external supplier.

Component Kits**

Part number	Code	Part number	Code	Part number	Code
Assembly for 25 mm² cable		Assembly for 35 mm² cable		Assembly for 50 mm² cable	
35039798	A	35039802	A	35039808	A
35039799	B	35039804	B	35039809	B
35039800	C	35039805	C	35039810	C
35039801	D	35039806	D	35039811	D

** Available configurations with associated BOM (Bill Of Materials).

DIMENSION MEASUREMENT SAMPLE

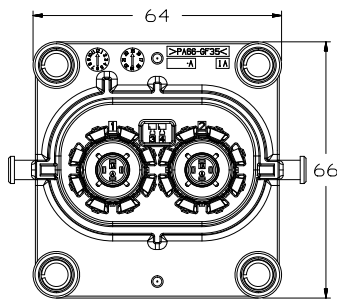

35166503

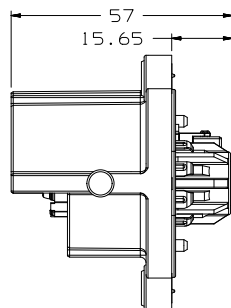

33355781

Part numbers, specifications, dimensions and performance data in this document are for general references only and are subject to change without notice. To verify product information, please contact an Aptiv representative.

HV RCS 890 SW SERIES



BENEFITS

- Specifically designed for compact environments
- High-water protections resulting from sealed unmated header
- Easy assembly thanks to slider feature on female connector

FEATURES

- Header has flat and simple device interface
- Connectors dismounting in 2 steps for time delay between interlock opening and power disconnection
- Slider solution offers the maximum pressure surface in limited space conditions

APPLICATIONS

AC / DC inverter

DC / DC converter

HV battery

Power electric box

HV PDU

AVAILABLE CONFIGURATIONS

Connector Type	Wire-to-device
Cable Exit Orientation	90°
Cable Range (mm ²)	35 - 70
Terminal Type	8 mm round contact system
# of Power Terminals	2
Shielding	Individual
HVIL	Shunt on female
Assembly Assurance	CPA
Number of Indexes	1

PERFORMANCE

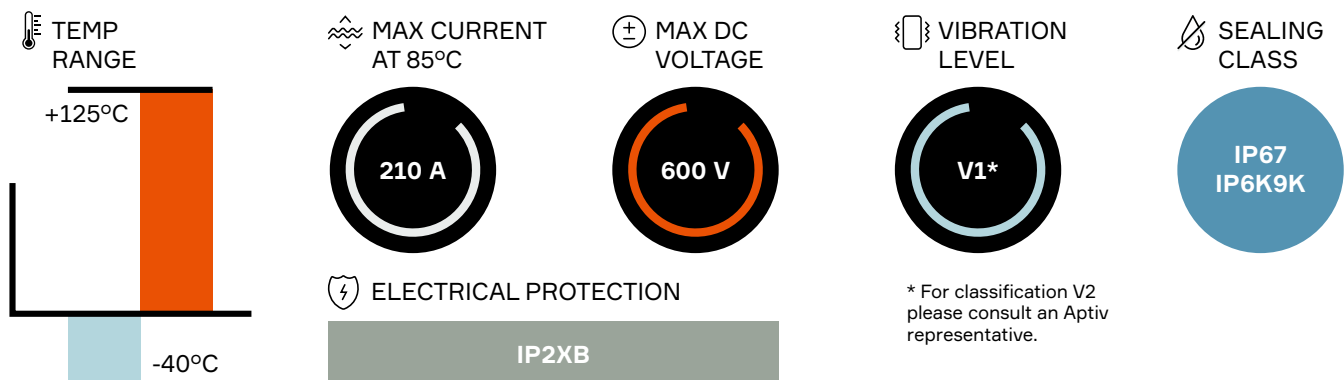

Header connector	Mating connector	BOM
35254402	35254366	1

ASSOCIATED PARTS

Part number	Description	BOM
Header		
15549847	DSQ 1.5 female terminal silver-plated 0.35 - 0.50 mm ²	2
15549848	DSQ 1.5 female terminal silver-plated 0.75 - 1.00 mm ²	
15441379	DCS/DSQ 1.5 male red single wire seal 0.22 - 0.5 mm ²	2
15441380	DCS/DSQ 1.5 male grey single wire seal 0.75 - 1.0 mm ²	
Mating Connector		
33502217	RCS890 female terminal silver-plated 35 - 50 mm ²	2
35166051	RCS890 female terminal silver-plated 70 mm ²	
35082415	Outer ferrule 35 mm ²	2
35234890	Outer ferrule 50 - 70 mm ²	
35084603	Recovery shield assembly 35 mm ²	2
35236787	Recovery shield assembly 50 - 70 mm ²	
35084610	Single wire seal & retainer 35 mm ²	2
35084586	Single wire seal & retainer 50 mm ²	
35236755	Single wire seal & retainer 70 mm ²	

DIMENSION MEASUREMENT SAMPLE

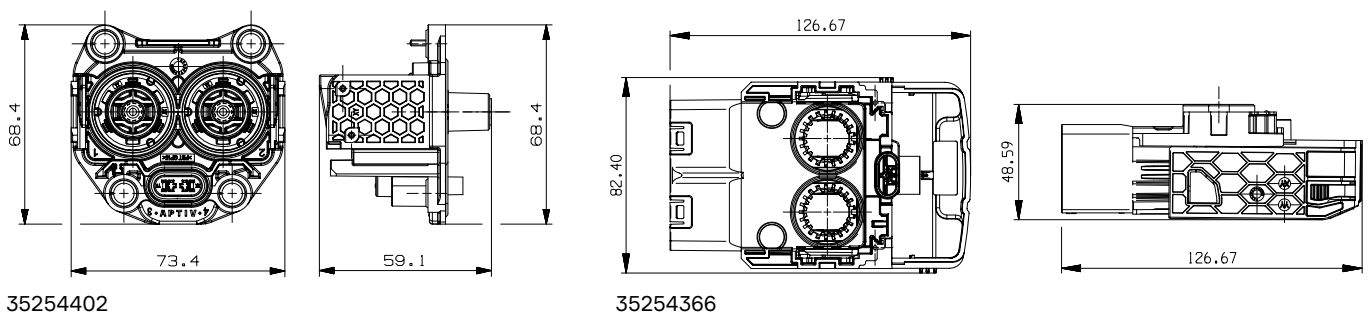

Part numbers, specifications, dimensions and performance data in this document are for general references only and are subject to change without notice. To verify product information, please contact an Aptiv representative.

HV RCS 800 SERIES



BENEFITS

- Easy to assemble with integrated ErgoMate™ Axial Mating Assist System on harness connector
- Compact package with unique integrated electric interlock
- Header is sealed in both mated and unmated positions

FEATURES

- Bundle shielding with external braid
- Panel mount to device with face seal to module
- Two-stage disconnect for safe unmating

APPLICATIONS

AC / DC inverter
 DC / DC converter
 HV battery
 Power electric box
 HV PDU

AVAILABLE CONFIGURATIONS

Connector Type	Wire-to-device
Cable Exit Orientation	180°
Cable Range (mm ²)	35 - 50 (power) 0.5 - 0.75 (HVIL)
Terminal Type	8 mm round contact system
# of Power Terminals	2
Shielding	Bundle
HVIL	Shunt on female
Assembly Assurance	CPA
Number of Indexes	2

PERFORMANCE

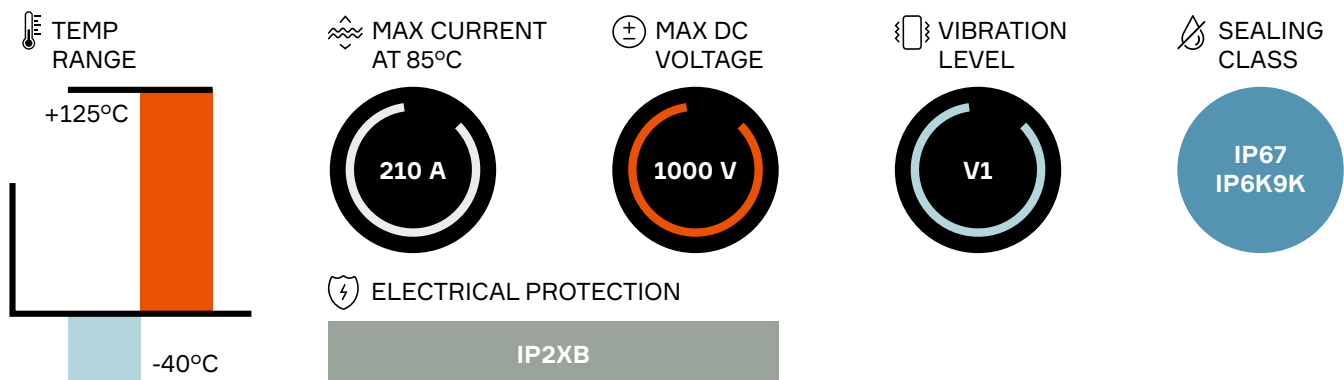

Index	Header connector	Mating connector	BOM
1	33511764	13974469	1
2	33511762	33511761	

ASSOCIATED PARTS

Part number	Description	BOM
Header		
33512193	RCS 800/890 male pin terminal silver version standard length	2
33511746	RCS 800/890 male pin terminal silver version V1 length	
33511747	RCS 800/890 male pin terminal silver version V2 length	
10779703	DCS2 1.5 male terminal gold-plated 0.5 - 1.0 mm ²	2
15441379	DCS/DSQ 1.5 red single wire seal 0.22 - 0.5 mm ²	2
15441380	DCS/DSQ 1.5 grey single wire seal 0.75 - 1.0 mm ²	
Mating Connector		
13893887	RCS 800 female terminal silver version 35 - 50 mm ²	2
13893889	RCS 800 female retainer (plug)	2
13893888	RCS 800 female 35 - 40 mm ² (plug)	2
13923559	RCS 800 female 50 mm ² (plug)	

DIMENSION MEASUREMENT SAMPLE

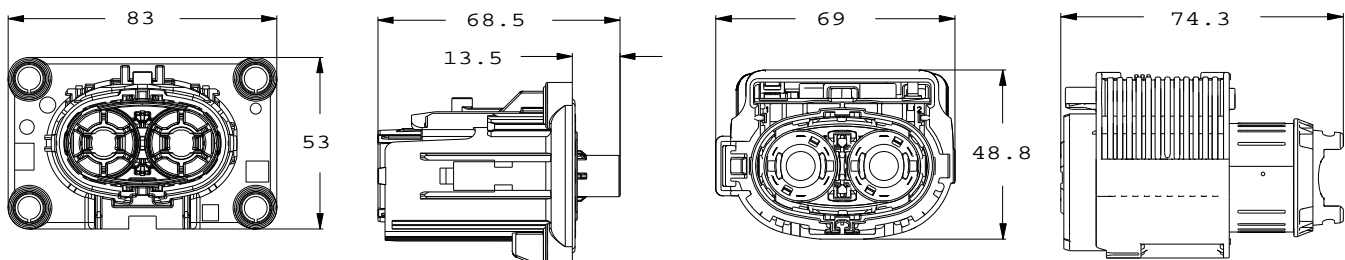

33511764

13974469

HV RCS 890 SERIES

FOR NEW DESIGN, CONSIDER THE NEW HV 890 RV SERIES



BENEFITS

- Easy to assemble with integrated ErgoMate™ Axial Mating Assist System on harness connector
- Compact package with unique integrated electric interlock
- Header is sealed in both mated and unmated position

FEATURES

- Bundle shielding with external braid
- Panel mount to device with face seal to module
- Two-stage disconnect for safe unmating

APPLICATIONS

AC / DC inverter
DC / DC converter
HV battery
Power electric box
HV PDU

AVAILABLE CONFIGURATIONS

Connector Type	Wire-to-device
Cable Exit Orientation	90°
Cable Range (mm ²)	35 - 50 (power) 0.5 - 0.75 (HVIL)
Terminal Type	8 mm round contact system
# of Power Terminals	2
Shielding	Bundle
HVIL	Shunt on female
Assembly Assurance	CPA
Number of Indexes	1

PERFORMANCE

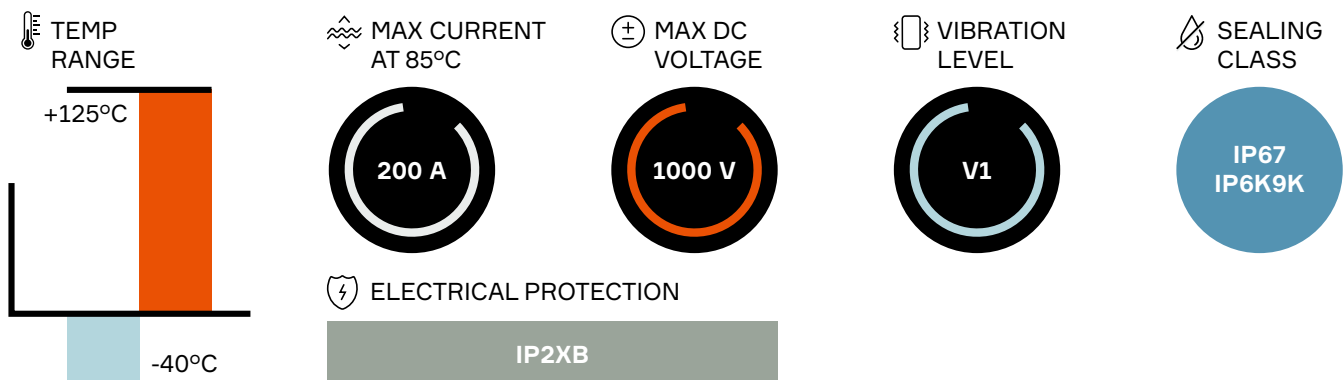

Header connector	Mating connector	BOM
33503821	33511750	1

ASSOCIATED PARTS

Part number	Description	BOM
Header		
33512193	RCS 800/890 male pin terminal silver version standard length	2
33511746	RCS 800/890 male pin terminal silver version V1 length	
33511747	RCS 800/890 male pin terminal silver version V2 length	
10811962	DCS2 1.5 female terminal gold-plated 0.5 - 1.0 mm ²	2
15441379	DCS/DSQ 1.5 red single wire seal 0.22 - 0.5 mm ²	2
15441380	DCS/DSQ 1.5 grey single wire seal 0.75 - 1.0 mm ²	
Mating Connector		
33511752	RCS 890 female terminal silver version 16 - 25 mm ²	2
33502217	RCS 890 female terminal silver version 35 - 50 mm ²	
35166051	RCS 890 female terminal silver version 70 mm ²	
33521619	RCS 890 single wire seal & retainer 16-25 mm ²	2
33511753	RCS 890 single wire seal & retainer 35 - 40 mm ²	
33511754	RCS 890 single wire seal & retainer 50 mm ²	
35199856	RCS 890 single wire seal & retainer 70 mm ²	
33504038	RCS 890 2-way half clamp	2

DIMENSION MEASUREMENT SAMPLE

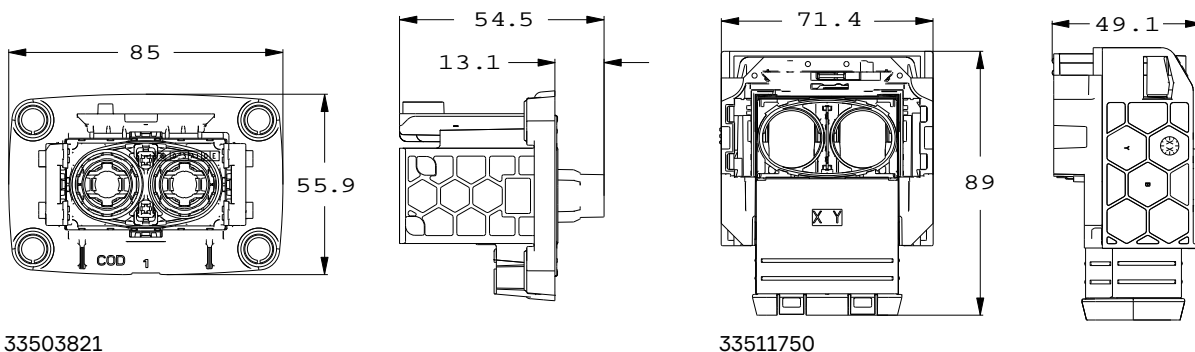

33503821

33511750

HV RCS 890 RV 2 WAY SERIES

USE FOR NEW DESIGN



BENEFITS

- Ultra compact design for applications with space constraints
- Panel mount to device with face seal to module
- Header is sealed in both mated and unmated position

FEATURES

- Two-stage disconnect for safe unmating
- Easier mating with Slider Mating Assist System on harness connector
- Bundle shielding with external braid
- HVIL shunted in harness connector

APPLICATIONS

AC / DC inverter
DC / DC converter
HV battery
Power electric box
HV PDU

AVAILABLE CONFIGURATIONS

Connector Type	Wire-to-device
Cable Exit Orientation	90°
Cable Range (mm ²)	16 - 70 (power) 0.35 - 1.0 (HVIL)
Terminal Type	8 mm round contact system
# of Power Terminals	2
Shielding	Bundle
HVIL	Shunt on female
Assembly Assurance	CPA
Number of Indexes	2

PERFORMANCE

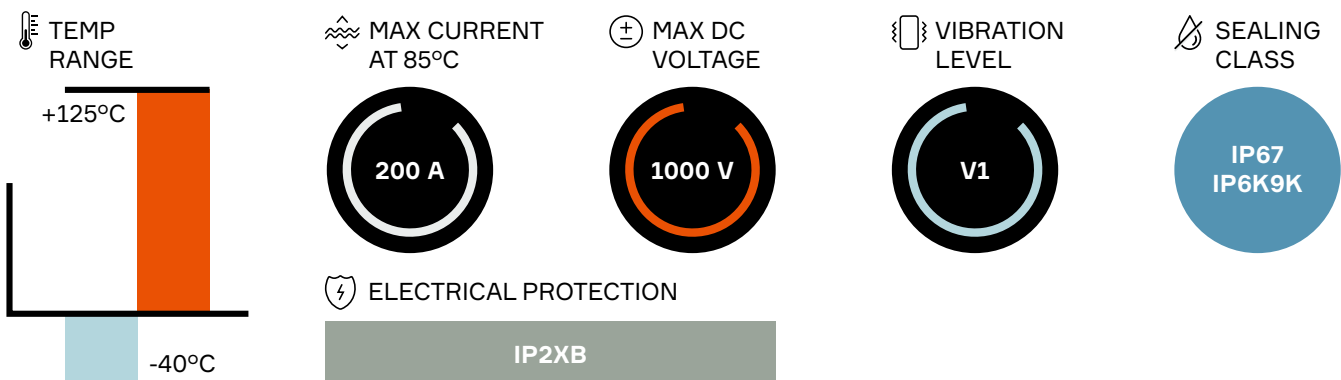

Index	Header connector	Mating connector	BOM
1	35326611	35092244	1
2	35326613	35092239	

ASSOCIATED PARTS

Part number	Description	BOM
Header		
10811962	DCS2 1.5 female terminal gold-plated 0.5 - 1.0 mm ²	2
15441379	DCS/DSQ 1.5 red single wire seal 0.35 - 0.5 mm ²	2
15441380	DCS/DSQ 1.5 grey single wire seal 0.75 - 1.0 mm ²	
33273083	RCS 800 male bus bar terminal silver version polarized pin	2
Mating Connector		
33511752	RCS 890 female terminal silver version 16 - 25 mm ²	2
33502217	RCS 890 female terminal silver version 35 - 50 mm ²	
35166051	RCS 890 female terminal silver version 70 mm ²	
33521619	RCS 890 single wire seal & retainer (plug) 16 - 25 mm ²	2
33511753	RCS 890 2-way female single wire seal & retainer (plug) 35 - 40 mm ²	
33511754	RCS 890 2-way female single wire seal & retainer (plug) 50 mm ²	
35199856	RCS 890 2-way female single wire seal & retainer (plug) 70 mm ²	
35091447	RCS 890 2-way half clamp	2

DIMENSION MEASUREMENT SAMPLE

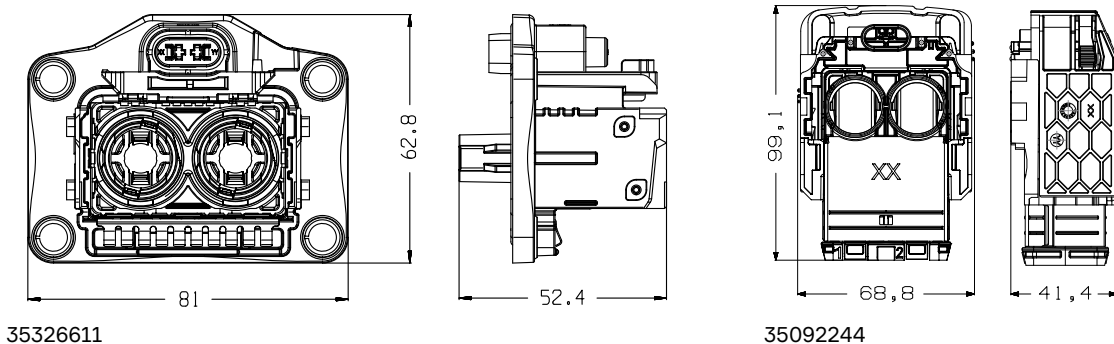

HV RCS 890 RV 3 WAY SERIES

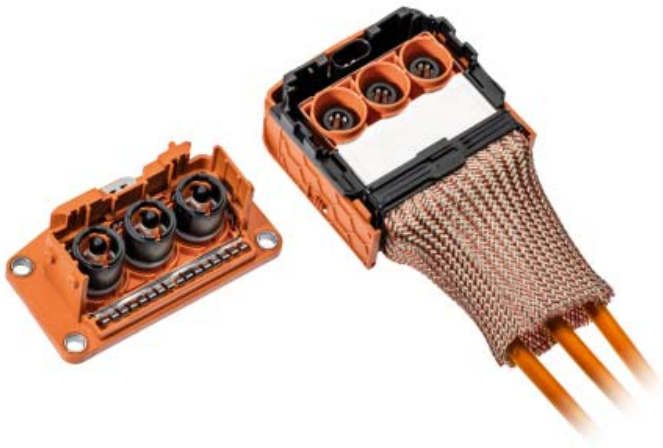

BENEFITS

- Ultra compact design for applications with space constraints
- Panel mount to device with face seal to module
- Header is sealed in both mated and unmated position

FEATURES

- Two-stage disconnect for safe unmating
- Easier mating with Slider Mating Assist System on harness connector
- Bundle shielding with external braid
- HVIL shunted in harness connector

APPLICATIONS

AC / DC inverter

DC / DC converter

HV battery

Power electric box

HV PDU

AVAILABLE CONFIGURATIONS

Connector Type	Wire-to-device
Cable Exit Orientation	90°
Cable Range (mm ²)	16 - 70 (power) 0.5 - 0.75 (HVIL)
Terminal Type	8 mm round contact system
# of Power Terminals	3
Shielding	Bundle
HVIL	Shunt on female
Assembly Assurance	CPA
Number of Indexes	2

PERFORMANCE

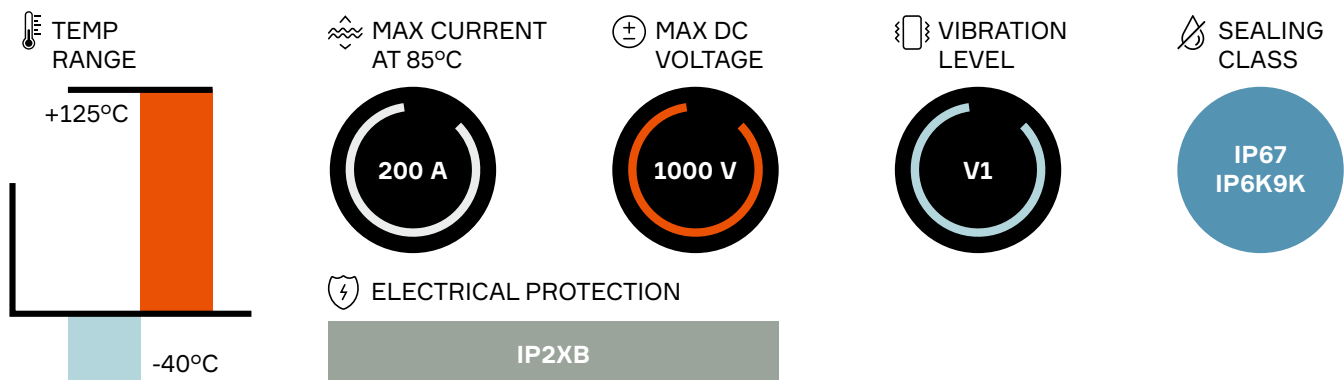

Index	Header connector	Mating connector	BOM
1	35310180	33272670	1
2	35310181	33282936	

ASSOCIATED PARTS

Part number	Description	BOM
Header		
33273083	RCS 800 male bus bar terminal silver version polarized pin	3
10811962	DCS2 1.5 female terminal gold-plated 0.5 - 1.0 mm ²	2
15441379	DCS/DSQ 1.5 red single wire seal 0.35 - 0.5 mm ²	2
15441380	DCS/DSQ 1.5 grey single wire seal 0.75 - 1.0 mm ²	
Mating Connector		
33511752	RCS 890 female terminal silver version 16 - 25 mm ²	3
33502217	RCS 890 female terminal silver version 35 - 50 mm ²	
35166051	RCS 890 female terminal silver version 70 mm ²	
33521619	RCS 890 single wire seal & retainer 16 - 25 mm ²	3
33511753	RCS 890 single wire seal & retainer 35 - 40 mm ²	
33511754	RCS 890 single wire seal & retainer 50 mm ²	
35199856	RCS 890 single wire seal & retainer 70 mm ²	
33272561	RCS 890 3-way half clamp	2

DIMENSION MEASUREMENT SAMPLE

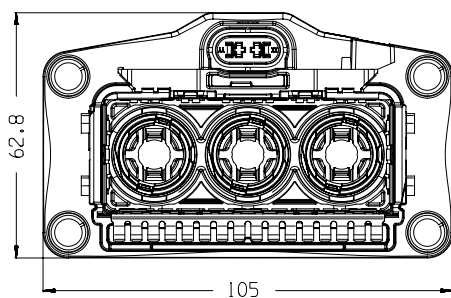

35310180

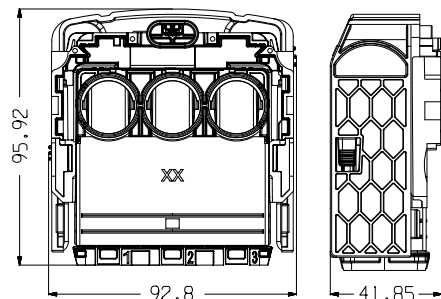
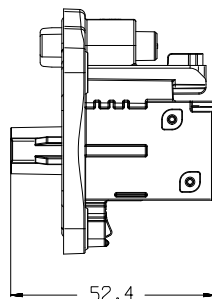

33272670

HV RCS 800

DIRECT MATE 1 WAY



BENEFITS

- Cost effective thanks to the direct connection between the female connector and the male terminals within the device case
- Unique and safe mating screwing with innovative Screw Position Assurance (SPA)
- Versatile solution covering multiple applications: high voltage power conversion and 48 volt

FEATURES

- Robust bolt driven mate assist
- Fingersafe via plastic tips on male pins
- Unshielded connector system

APPLICATIONS

AC / DC inverter

DC / DC converter

HV battery

Power electric box

HV PDU

AVAILABLE CONFIGURATIONS

Connector Type	Wire-to-device
Cable Exit Orientation	180°
Cable Range (mm ²)	35 - 50 (power)
Terminal Type	8 mm round contact system
# of Power Terminals	1
Shielding	None
HVIL	None
Assembly Assurance	SPA
Number of Indexes	1

PERFORMANCE

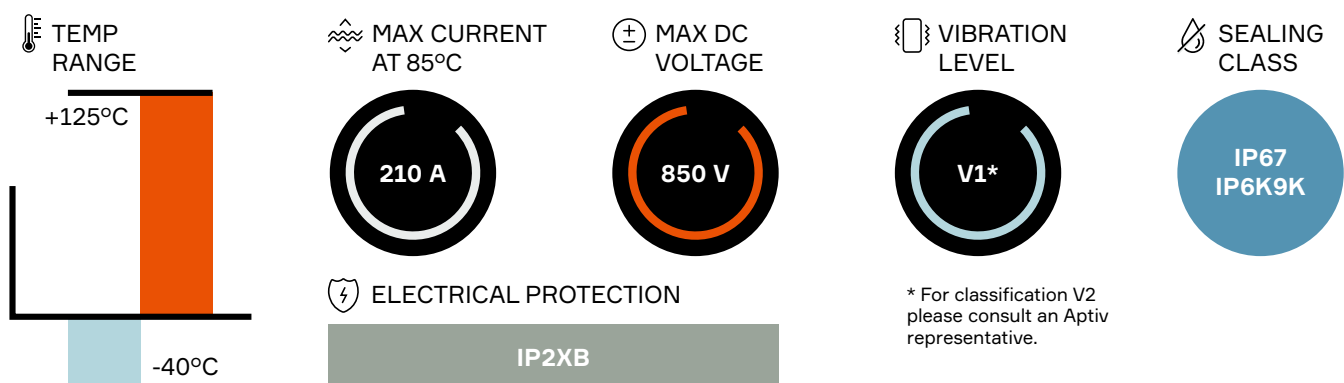

Header connector*	Mating connector	BOM
35098440	35098437	1

* Header connector is a fully assembled part and therefore has no associated parts.

ASSOCIATED PARTS

Part number	Description	BOM
Mating Connector		
13893887	RCS 800 female terminal 35 - 50 mm ²	1
13893888	Female black single wire seal 35 mm ²	1
13923559	Female grey single wire seal 50 mm ²	
13893889	Retainer	1

DIMENSION MEASUREMENT SAMPLE

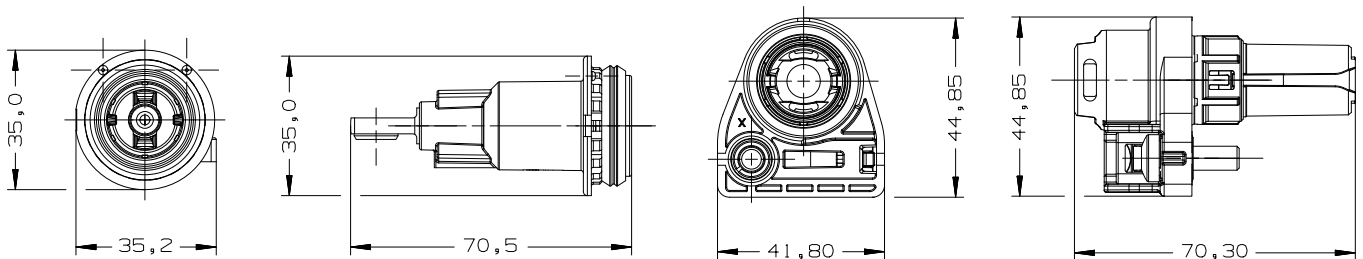

35098440

35098437

Part numbers, specifications, dimensions and performance data in this document are for general references only and are subject to change without notice. To verify product information, please contact an Aptiv representative.

HV RCS 800

DIRECT MATE 2 WAY



BENEFITS

- Cost effective solution with unshielded terminal holder within device replacing traditional shielded headers
- Unique and safe mating screwing with innovative Screw Position Assurance (SPA)
- Header is sealed in both mated and unmated position

FEATURES

- Robust bolt driven mate assist
- Fingersafe via plastic tips on male pins
- Cable range: ~ 50 mm² and smaller

APPLICATIONS

AC / DC inverter

DC / DC converter

HV battery

Power electric box

HV PDU

AVAILABLE CONFIGURATIONS

Connector Type	Wire-to-device
Cable Exit Orientation	180°
Cable Range (mm ²)	35 - 50 (power) 0.35 - 1.0 (HVIL)
Terminal Type	8 mm round contact system
# of Power Terminals	2
Shielding	Individual
HVIL	Shunt on female
Assembly Assurance	SPA
Number of Indexes	1

PERFORMANCE

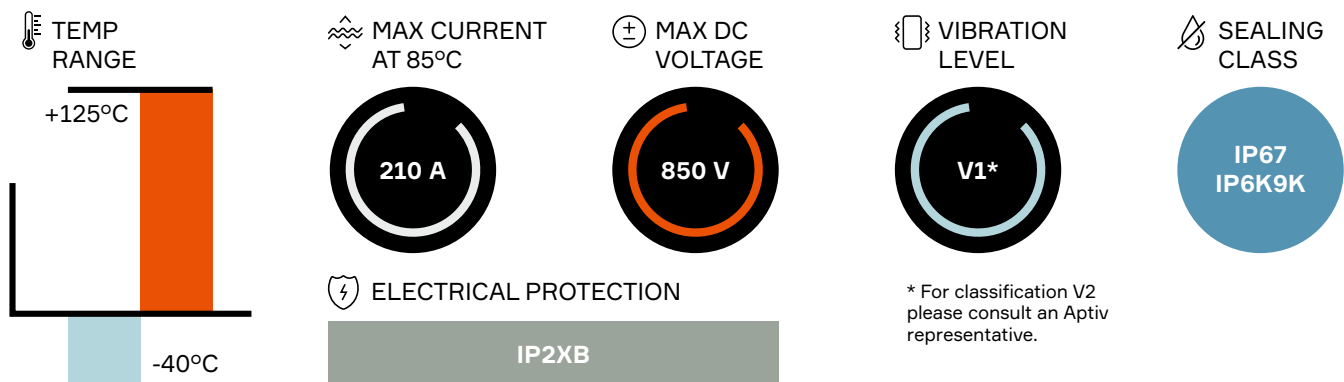

Header*	Header with HVIL**	Mating connector	BOM
35099885	35099880	35098453	1

* Header connector is a fully assembled part and therefore has no associated parts.
 ** Please contact your local Aptiv representative for serial production information.

ASSOCIATED PARTS

Part number	Description	BOM
Mating connector		
13893887	RCS 800 female terminal silver-plated 35 - 50 mm ²	2
35082410	Inner ferrule 35 and 50 mm ²	2
35082415	Outer ferrule 35 and 50 mm ²	2
35099247	Single wire seal & retainer 35 mm ²	2
35099248***	Single wire seal & retainer 50 mm ²	
35092416	RCS800 tube 35 - 50 mm ²	2

*** Available only by prototype, please contact your local Aptiv representative for more information on serial production.

DIMENSION MEASUREMENT SAMPLE

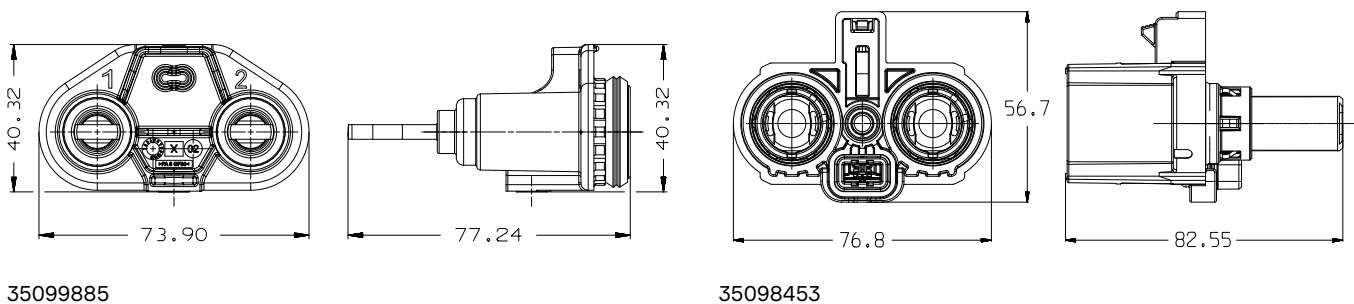

35099885

35098453

Part numbers, specifications, dimensions and performance data in this document are for general references only and are subject to change without notice. To verify product information, please contact an Aptiv representative.



HV RCS 890

DIRECT MATE 2 WAY



BENEFITS

- Cost effective solution with unshielded terminal holder within device replacing traditional shielded headers
- Unique and safe mating screwing with innovative Screw Position Assurance (SPA)
- Header is sealed in both mated and unmated position

FEATURES

- Robust bolt driven mate assist
- Fingersafe via plastic tips on male pins
- Cable range: ~ 50 mm² and smaller

APPLICATIONS

AC / DC inverter

DC / DC converter

HV battery

Power electric box

HV PDU

AVAILABLE CONFIGURATIONS

Connector Type	Wire-to-device
Cable Exit Orientation	90°
Cable Range (mm ²)	35 - 50 (power) 0.35 - 1.0 (HVIL)
Terminal Type	8 mm round contact system
# of Power Terminals	2
Shielding	Individual
HVIL	Shunt on female
Assembly Assurance	SPA (Screwed Position Assurance)
Number of Indexes	1

PERFORMANCE

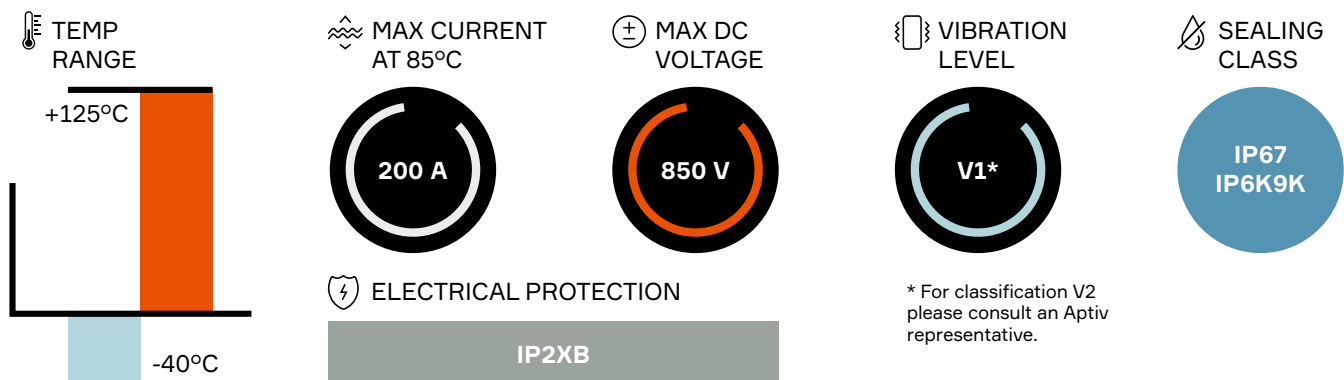

Header	Mating connector	BOM
35084594	35084575	1

ASSOCIATED PARTS

Part number	Description	BOM
Header		
15549847	DSQ 1.5 female terminal silver-plated 0.35 - 0.50 mm ²	2
15549848	DSQ 1.5 female terminal silver-plated 0.75 - 1.00 mm ²	
15441379	DCS/DSQ 1.5 red single wire seal 0.22 - 0.5 mm ²	2
15441380	DCS/DSQ 1.5 grey single wire seal 0.75 - 1.0 mm ²	
Mating connector		
33502217	RCS 890 female terminal silver-plated 35 - 50 mm ²	2
35082415	Outer ferrule 35 mm ²	2
35234890	Outer ferrule 50 mm ²	
35084603	Recovery shield assembly 35 mm ²	2
35236787	Recovery shield assembly 50 mm ²	
35084610	Single wire seal & retainer 35 mm ²	2
35084586	Single wire seal & retainer 50 mm ²	

DIMENSION MEASUREMENT SAMPLE

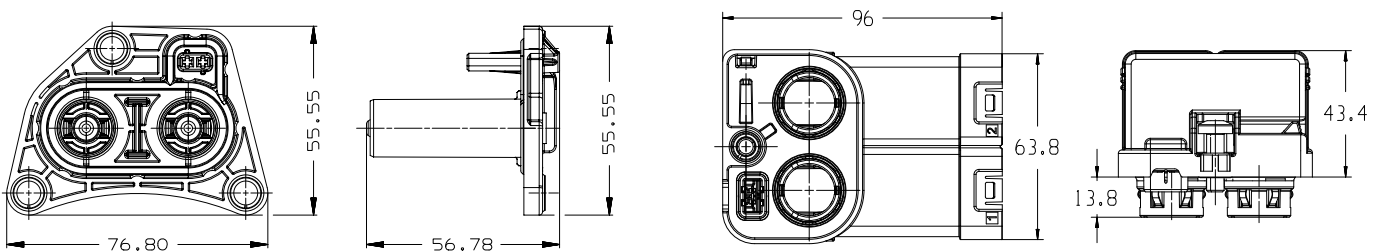

35084594

35084575

Part numbers, specifications, dimensions and performance data in this document are for general references only and are subject to change without notice. To verify product information, please contact an Aptiv representative.



SHIELD-PACK™ HV2000



BENEFITS

- Header interface is integrated into device case
- Cost-effective full plastic header assembled from inside out
- Bolt driven mate assist
- Ultrasonic welding used for power terminal

FEATURES

- Internal HVIL shunted in harness connector
- Finger proof and non-finger proof options available
- Provides finger proof terminal towers and HVIL
- Header accepts busbars provided by module

APPLICATIONS

AC / DC inverter

DC / DC converter

HV battery

Power electric box

HV PDU

AVAILABLE CONFIGURATIONS

Connector Type	Wire-to-device
Cable Exit Orientation	90°
Cable Range (mm ²)	35 - 50 (power) 0.5 (HVIL)
Terminal Type	Power Pack 2000 17.7
# of Terminals	2
Shielding Type	Individual
HVIL	Shunt on female
Assembly Assurance	CPA/TPA
Number of Indexes	1

PERFORMANCE

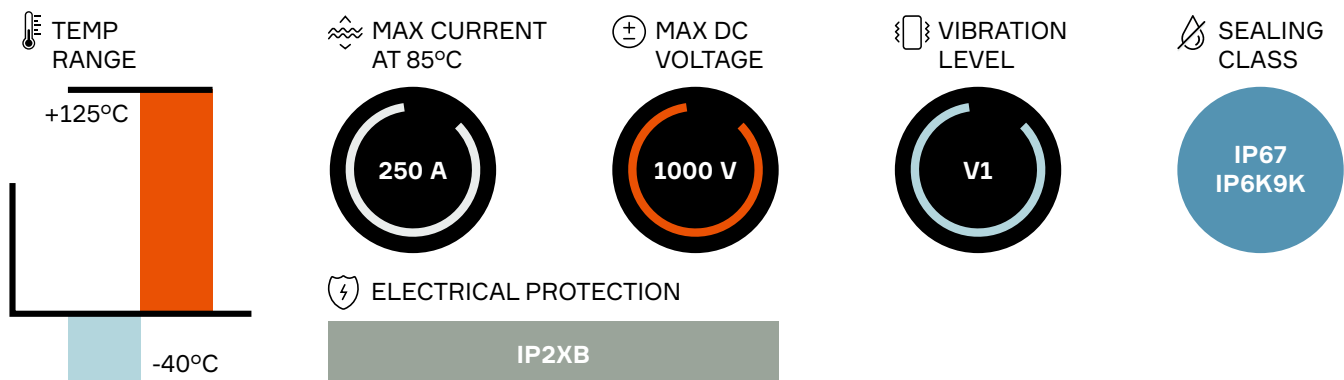

Header connector	Mating connector	BOM
33346375	33352038	1

ASSOCIATED PARTS

Part number	Description	BOM
Header		
15432237	CTS female terminal silver-plated HVIL 0.35 mm ²	2
33346276	HVIL TPA	1
Mating Connector		
13801592	Power Pack 2000 female sonic weld terminal	2
33352058	Inner ferrule 35 mm ²	2
33352059	Inner ferrule 50 mm ²	2
33352056	Outer ferrule 35 mm ² & 50 mm ²	2
33352048	Cable seal 35 mm ²	2
33352049	Cable seal 50 mm ²	2
33352051	Strain relief 35 mm ²	2
33352052	Strain relief 50 mm ²	2
33352055	TPA	1
13849267	Fastener M5	1

DIMENSION MEASUREMENT SAMPLE

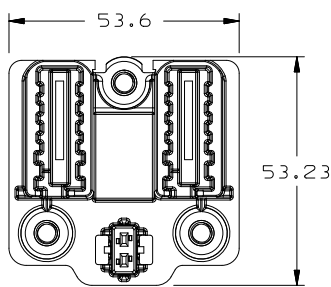

33346375

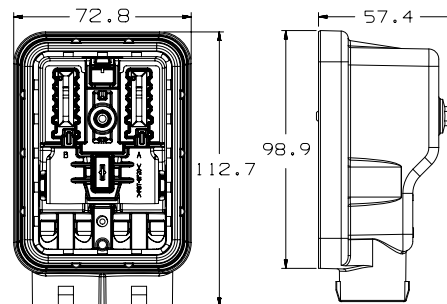

33352038

Part numbers, specifications, dimensions and performance data in this document are for general references only and are subject to change without notice. To verify product information, please contact an Aptiv representative.

HV AK PASS-THROUGH AK



BENEFITS

- Very compact dimensions
- High robustness against vibrations
- Higher operating temperatures

FEATURES

- Ring terminal is bolted to device
- Cables are 360° individually shielded
- High voltage panel mount system
- Fully interchangeable with other AK supplier sources

APPLICATIONS

AC / DC inverter

HV battery

HV PDU

Power electric box

E-motor

AVAILABLE CONFIGURATIONS

Connector Type	Pass-through
Cable Exit Orientation	180°
Cable Range (mm ²)	16 - 50 (power)
Terminal Type	O-ring
Shielding	Individual
HVIL	None

PERFORMANCE

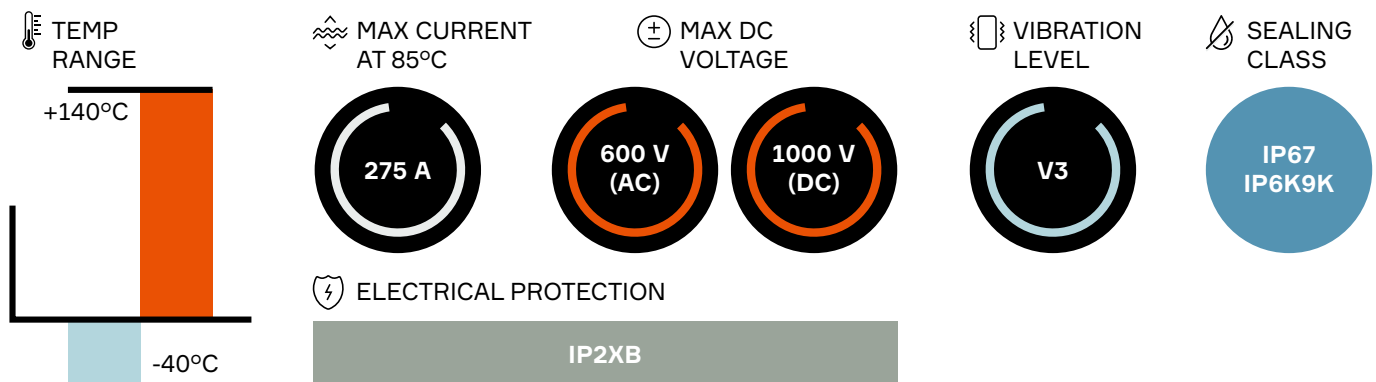

Main Housing Body Components

Code	Number of ways			BOM
	1	2	3	
A	33340524	33340525	33340526	1
B	35066699	-	-	

ASSOCIATED PARTS

Description	Cable size				BOM*
	16 mm ²	25 mm ²	35 mm ²	50 mm ²	
Peripheral seal	35116341				1, 2 or 3
Inner ferrule	35172747				1, 2 or 3
Outer ferrule	33340554	35172745	35172743	33340551	1, 2 or 3
Single wire seal	33340537	35172739	35172738	33340534	1, 2 or 3
Cable strain relief	33340542	33340541	33340540	33340539	1, 2 or 3

* Depending on if the component is for 1, 2 or 3 Way pass-through.

Component Kits**

Code	Cable size				BOM
	16 mm ²	25 mm ²	35 mm ²	50 mm ²	
1 Way					
A	33350177	33350176	33350175	33349598	1
B	-	-	-	35083309	1
2 Way					
A	33350180	33350179	3335178	33349600	2
3 Way					
A	33350183	33350182	33350181	33350072	3

** Available configurations with associated BOM (Bill Of Materials).

DIMENSION MEASUREMENT SAMPLE

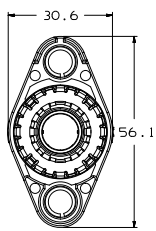

33340524

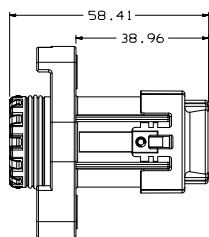

33340525

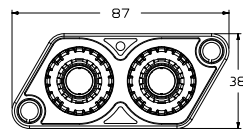

33340526

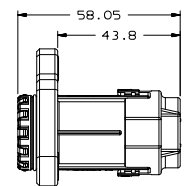
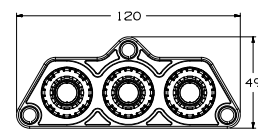
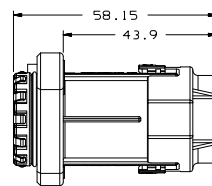

HV METAL PASS-THROUGH



BENEFITS

- Robust design for harsh environments
- Very compact dimensions
- Wide variety of indexes depending on wire sections

FEATURES

- High voltage panel mount system
- 1 Way sealed and shielded solution
- Ring terminal bolted to device

APPLICATIONS

AC / DC inverter

HV battery

HV PDU

Power electric box

E-motor

AVAILABLE CONFIGURATIONS

Connector Type	Pass-through
Cable Exit Orientation	180°
Cable Range (mm ²)	25 - 50 (power)
Terminal Type	Ring
# of Power Terminals	1
Shielding	Individual
HVIL	None
Number of Indexes	6-8, depending on wire section

PERFORMANCE

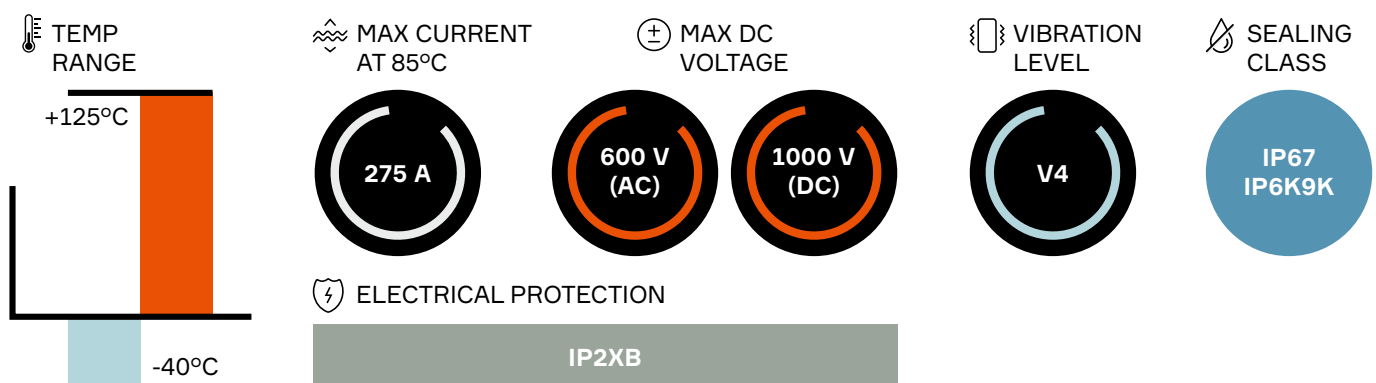

Main Housing Body Components

Index	25 mm ² wire section	35 mm ² wire section	50 mm ² wire section	BOM
102	13888001	13894189	33112598	1
103	13888002	13894190	33112599	
104	13888003	13894191	33112600	
105	13888004	13894192	33112601	
106	-	-	33112602	
107	-	-	33112608	
108	33253253	33253255	33112609	
109	33253254	33253256	33112610	

ASSOCIATED PARTS

Part number	Description	Part number	Description	Part number	Description
25 mm²		35 mm²		50 mm²	
13888023	25 mm ² seal retainer	13894241	35 mm ² seal retainer	33112613	50 mm ² seal retainer
13888030	25 mm ² seal	33288396	35 mm ² seal	33112616	50 mm ² seal
13888025	O-ring seal	13888025	O-ring seal	13888025	O-ring seal
33295901	25 mm ² ferrule	33295902	35 mm ² ferrule	33295903	50 mm ² ferrule

DIMENSION MEASUREMENT SAMPLE

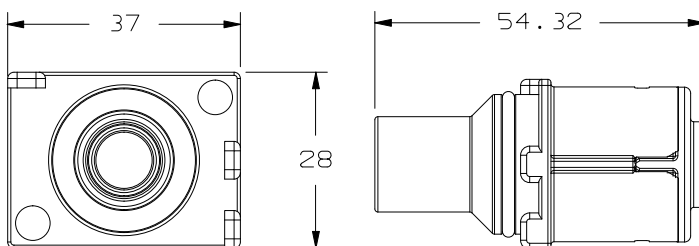

13888001

12, 24 & 48 Volt Solutions

SELECTOR GUIDE

APPLICATIONS:

- 48V electrical centers
- Power distribution boxes
- Start-stop systems
- E-turbo
- Battery
- Active suspension
- BSG units
- High current harness and devices
- Sealed pass-through panel mount systems

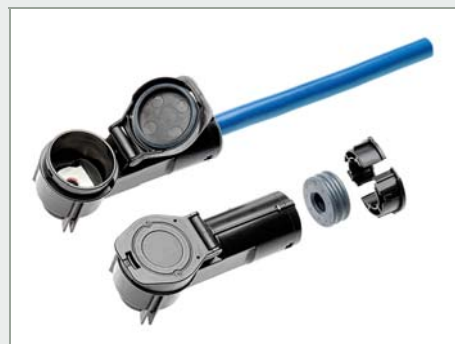

Application	48V electrical centers, Power distribution boxes, Start-stop systems, E-turbo, Battery, Active suspension, BSG units
Description	SEALED RING CONNECTOR
Amperage at 85°C	250 A
Voltage	12 - 48 V
Orientation	90°
# of Ways	1
Shielding	No
Vibration Class	V3
Temperature Class	T4
Sections	35 mm ² 50 mm ²
See Page	60-61



High current harnesses and devices,
Sealed pass-through panel mount systems

1 WAY INLINE CONNECTORS	2 WAY INLINE CONNECTORS	2 WAY DEVICE CONNECTOR with straight and right angle Exit
	145 A	
	12 - 48 V	
180°	180°	90° & 180°
	1 & 2	
	No	
	V1	
	T3	
	8 - 25 mm ²	
	62-63	

48V SEALED RING CONNECTOR



BENEFITS

- Fast and easy assembly process
- High robustness against vibrations
- High current carrying capabilities

FEATURES

- Ideal solution for 12 to 48V requiring sealed ring connections
- Can be screwed from the top
- Header interface available for system supplier integration on the box
- M8 ring terminal bolted to device

APPLICATIONS

48V electrical centers

Power distribution boxes

Start-stop systems

E-turbo

Battery

Active suspension

BSG units

AVAILABLE CONFIGURATIONS

Connector Type	Wire-to-device
Cable Exit Orientation	90°
Cable Range (mm ²)	35, 50
Terminal Type	M8 ring terminal
# of Power Terminals	1
Shielding Type	Unshielded
HVIL	None
Assembly Assurance	None
Number of Indexes	1

PERFORMANCE

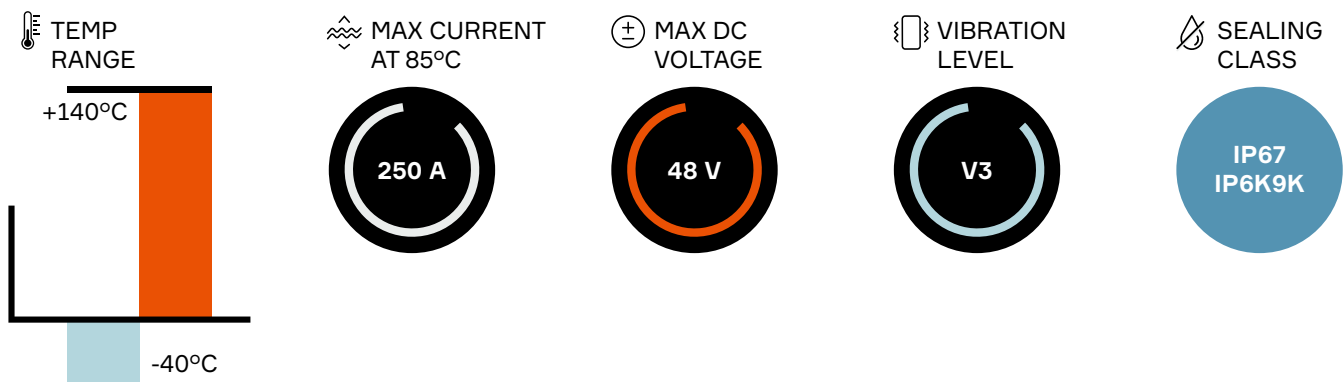

Mating connector	Header connector	BOM
33376962	Please contact you Aptiv representative for more information	1

ASSOCIATED PARTS

Part number	Type	Applicable wire size (mm ²)	Cable type	BOM
33376821	Single wire seal retainer	35 - 50	-	1
33329995	M8 O-ring terminal	35 - 50	-	1
35093138	Single wire seal	35	Unshielded	1

DIMENSION MEASUREMENT SAMPLE

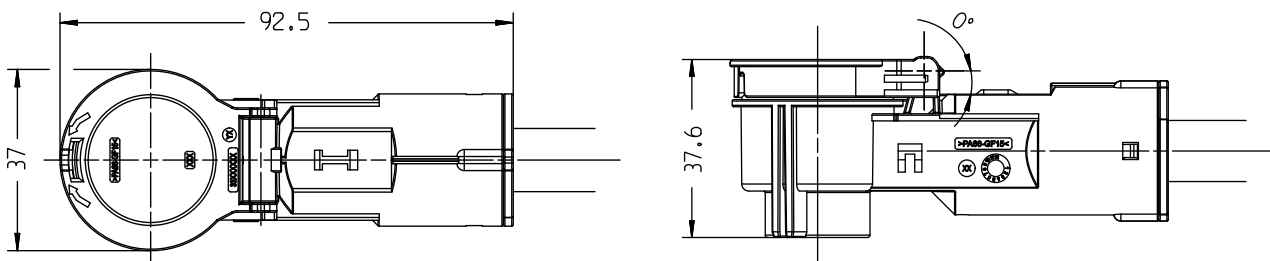

33376962

Part numbers, specifications, dimensions and performance data in this document are for general references only and are subject to change without notice. To verify product information, please contact an Aptiv representative.

POWER PACK 1000



1 Way Inline Connectors



2 Way Inline Connectors



2 Way Device and Pass-Through Connectors

BENEFITS

- High current carrying capacity
- Proven terminal system
- Compact system design
- Field proven in both automotive and heavy duty applications

FEATURES

- Silver-plated multi-contact terminal system
- Sealed panel mount pre-stages prior to fastening
- Panel mount secured in place with self-tapping screws
- Pass-through connection accepts both straight and right angle connectors

AVAILABLE CONFIGURATIONS

Connector Type	Wire-to-device, wire-to-wire, pass-through
Cable Exit Orientation	180°, 90°
Cable Range (mm ²)	8 - 25
Terminal Type	Power Pack 1000
# of Power Terminals	1 or 2
Shielding Type	Unshielded
HVIL	None
Assembly Assurance	None
Number of Indexes	2

APPLICATIONS

High current harnesses and devices

Sealed pass-through panel mount systems

PERFORMANCE

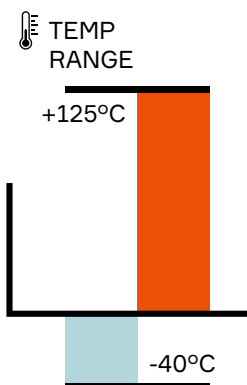

MAX CURRENT AT 85°C



MAX DC VOLTAGE



VIBRATION LEVEL

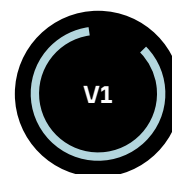

SEALING CLASS



1 Way Inline Connectors

Header connector	Mating connector	BOM
13882980	13952702	1

2 Way Inline Connectors

Index	Header connector	Mating connector	BOM
103	13849747	13849756	1
104	13849748	13849757	

2 Way Device and Pass-Through Connectors

Index	Header connector	Mating connector		BOM
		180°	90°	
103	13959824	13849756	13849758	1

ASSOCIATED PARTS

Part number	Description	BOM
Header / Male inline		
13675577	PP1000 silver-plated 8 - 10 mm ²	1
13675579	PP1000 silver-plated 19 - 25 mm ²	
Mating connector		
13675583	PP1000 silver-plated 8 - 10 mm ²	1
13675585	PP1000 silver-plated 19 - 25 mm ²	
Seals and Retainers*		
13675510	Cable seal PP1000 4.54 - 5.79 dia cable (grey) 8 - 10 mm ²	1
13675513	Cable seal PP1000 1.01 - 9.19 dia cable (blue) 19 - 25 mm ²	
13849785	Cable seal retainer PP1000 8 - 10 mm ²	1
13849788	Cable seal retainer PP1000 19 - 25 mm ²	

* For both header, male inline + mating connector

DIMENSION MEASUREMENT SAMPLE

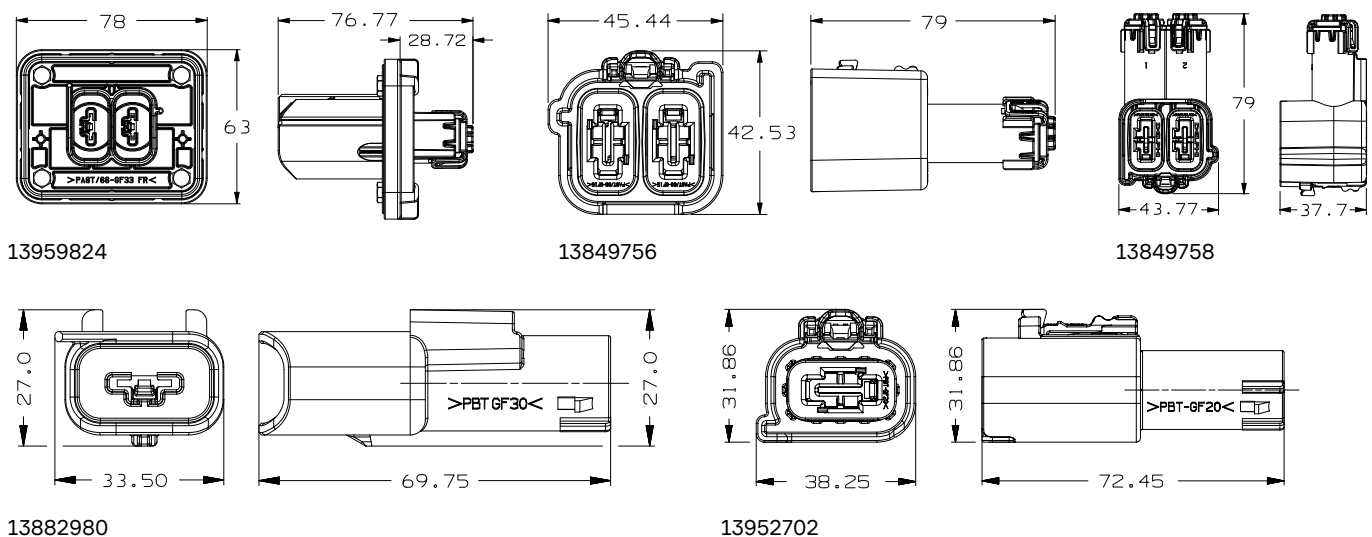

Part numbers, specifications, dimensions and performance data in this document are for general references only and are subject to change without notice. To verify product information, please contact an Aptiv representative.

Charging Solutions

SELECTOR GUIDE





APPLICATIONS:

- On-vehicle charging inlets
- Grid-to-vehicle charging
- Charging infrastructure-to-vehicle

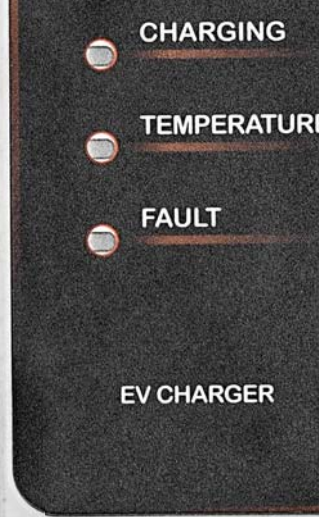

			
Application	Cable assemblies for integration into charging stations	Charging between vehicle and charge station	Grid to vehicle charging
Description	CHARGE PIGTAILS	CHARGE MODE 3 JUMPER CABLE	CHARGE MODE 2 CABLE
Mating cycles	10 000	10 000 / 14 000	10 000
# of phases	1 or 3	1 & 3	1
Amperage	16 - 40 A (AC)	20 - 32 A (AC)	6 - 14 A (AC)
Voltage	120 - 480 V (AC)	240 - 400 V (AC)	240 V (AC)
Wire selections	-	-	-
Cable length	5 - 7.6 m	4 - 7 m	5 m
See Page	66-67	68-69	70-71



			
Plug-in hybrid and electric vehicle AC charge inlet	Plug-in hybrid and electric vehicle AC charge inlet	Charging interface for slow AC and fast DC charging	Charging interface for slow AC and fast DC charging
CHARGE INLET TYPE I	CHARGE INLET TYPE II	COMBO 1	COMBO 2
10 000	10 000	10 000	10 000
1	1 or 3	1	1 or 3
15 - 32 A (AC)	16 - 63 A (AC)	32 A (AC) 125 A (DC)	20 A (AC) 125 A (DC)
120 V (AC Level 1) 240 V (AC Level 2)	400 V (AC)	250 V (AC) 600 V (DC)	480 V (AC) 600 V (DC)
2 - 5 mm ²	2.5 - 16 mm ²	6 mm ² (AC) 35 mm ² (DC)	4 mm ² (AC) 35 mm ² (DC)
-	-	-	-
72-73	74-75	76-77	78-79

CHARGE PIGTAILS



BENEFITS

- Superior durability and proven in automotive mass production
- Vehicle to charging station connection
- UL, CE, CQC marking/certification

FEATURES

- SAE J1772/IEC62196 Type I, IEC62196 Type II, and GB/T 20234 standards
- Wiring crimps sealed from environment
- Different design options

APPLICATIONS

Grid-to-vehicle

Infrastructure to electric vehicle charging

AVAILABLE CONFIGURATIONS

Design

Plastic handle or rubber over mold

Outlet Standard

UL, CE, CQC

TECHNICAL CHARACTERISTICS

Mating Cycles

10 000

PERFORMANCE

TEMP RANGE

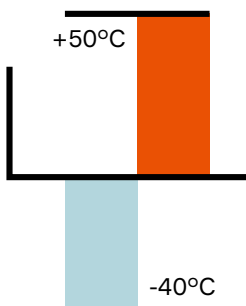

MAX CURRENT AT 85°C

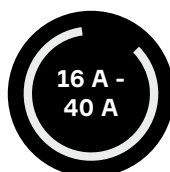

MAX DC VOLTAGE

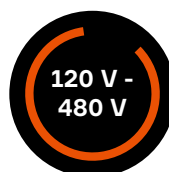

VIBRATION LEVEL

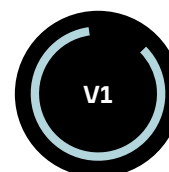

SEALING CLASS



Individual wiring crimps

Part number	Type (veh/wall)	Design	Current	# Phase	Cable Length	Cable Section	Certification
33248422	Type I/SAE J1772	Plastic Handle	18A	1-phase	7.0 / 23	3G AWG14 + 0.8	UL
33248425	Type I/SAE J1772	Plastic Handle	25A	1-phase	7.6 / 25	3G AWG12 + 0.8	UL
35078184	Type I/SAE J1772	Plastic Handle	40A	1-phase	7.6 / 25	3G AWG10 + 0.8	UL
33155748	Type I	Rubber Over Mold	20A	1-phase	5.0 / 16.40	3G2.5 + 0.5	CE
33155747	Type II	Rubber Over Mold	20A	1-phase	5.0 / 16.40	3G2.5 + 0.5	CE
33155746	Type II	Rubber Over Mold	20A	3-phase	5.0 / 16.40	5G6 + 0.5	CE
33155745	Type II	Rubber Over Mold	32A	3-phase	5.0 / 16.40	5G6 + 0.5	CE
33502596	Type II	Plastic Handle	16A	1-phase	6.5 / 21.32	3G2.5 + 0.75	CE
33366532	GBT	Plastic Handle	16A	1-phase	7.5 / 24.6	3G2.5 + 0.5	CQC
33366674	GBT	Plastic Handle	32A	1-phase	7.5 / 24.6	3G2.5 + 0.75	CQC

For more specific information, please contact your Aptiv representative.

COMPATIBLE WITH



*For more information, please contact your Aptiv representative

DIMENSION MEASUREMENT SAMPLE

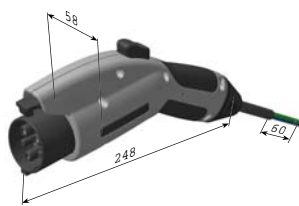

Type I
Rubber Over Mold

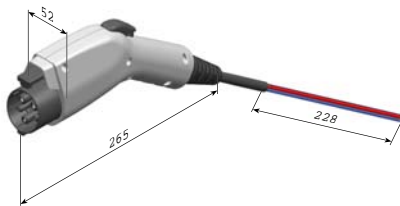

Type I/SAE J1772
Plastic Handle

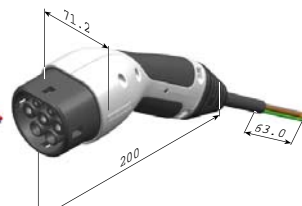

Type II
Rubber Over Mold

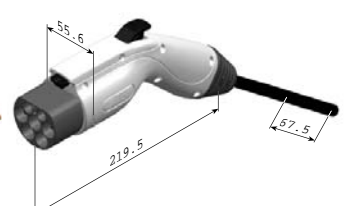

GBT
Plastic Handle

Part numbers, specifications, dimensions and performance data in this document are for general references only and are subject to change without notice. To verify product information, please contact an Aptiv representative.

CHARGE MODE 3 JUMPERS CABLE



BENEFITS

- Superior durability and proven in automotive mass production
- Wiring crimps sealed from environment
- CE and CQC marking/certification

FEATURES

- Vehicle connector according to IEC62196-2-1/IEC62196-2-2 and GB/T 20234
- Superior durability: 14,000 cycles (while IEC standard only requires 10,000 cycles)
- Low mating/unmating forces: Initial < 40N, Mating forces < 80N guaranteed until 14,000 cycles

APPLICATIONS

Cable assemblies for plugging from charging stations to vehicle

AVAILABLE CONFIGURATIONS

Design	Plastic handle
Outlet Standard	CE, CQC
Configurations	T2-T2, T1-T2, T1-T3, GBT-GBT

TECHNICAL CHARACTERISTICS

Mating Cycles 14 000 (CE Products),
10 000 (CQC Products)

PERFORMANCE

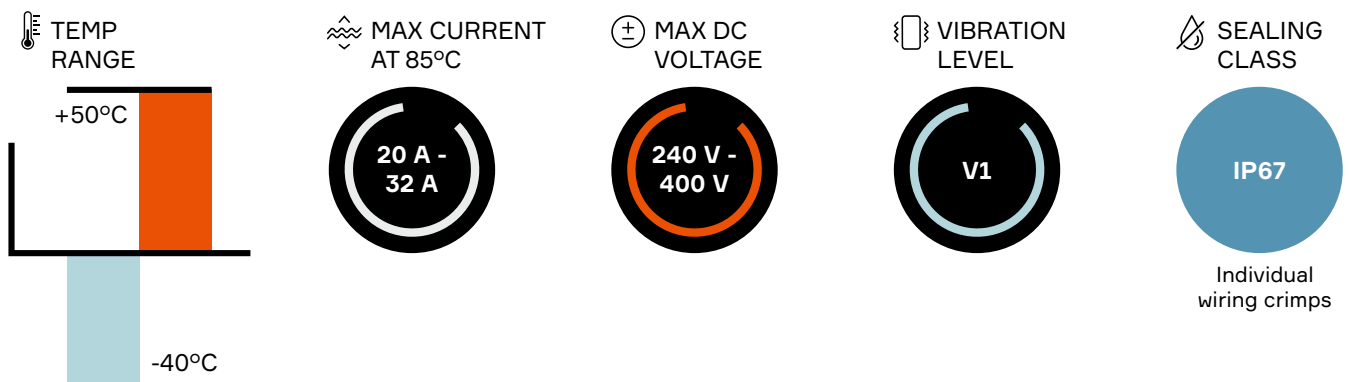

Part number	Type (veh/wall)	Current	# Phase	Cable length	Cable section	Certification
33358146	Jumper T2 - T2	20A	3-phase	6.5 / 21.32	5G4 + 0.75	CE
35137656	Jumper T2 - T2	32A	3-phase	4.0 / 13.12	5G6 + 0.75	CE
35141693	Jumper T2 - T2	32A	3-phase	6.5 / 21.32	5G6 + 0.75	CE
35341995	Jumper T2 - T2	32A	1-phase	5.0 / 16.40	3G6 + 0.75	CE
33401184	Jumper T1 - T2	20A	1-phase	6.0 / 19.68	3G2.5 + 0.75	CE
33403378	Jumper T1 - T2	32A	1-phase	6.0 / 19.68	3G6 + 0.75	CE
33295948	Jumper GBT - GBT	16A	1-phase	5.0 / 16.40	3G2.5 + 0.5	CQC
33295463	Jumper GBT - GBT	32A	1-phase	7.0 / 22.96	3G6 + 0.5	CQC

COMPATIBLE WITH



*For more information, please contact your Aptiv representative

DIMENSION MEASUREMENT SAMPLE

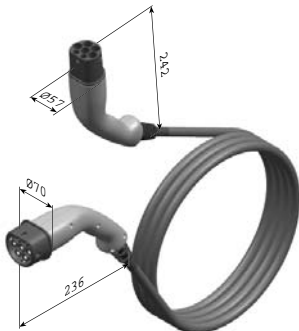

33358146

Part numbers, specifications, dimensions and performance data in this document are for general references only and are subject to change without notice. To verify product information, please contact an Aptiv representative.

CHARGE MODE 2 CABLE



BENEFITS

- Superior durability and proven in automotive mass production
- Dual-thermo sensors in the grid plug provide superior overheating protection
- Grid cord as required by country of use

FEATURES

- EVSE provides restart in the event of power grid fault
- Product according to the new IEC62752 standard including Type B RCD and residential DC current detection
- Superior control box water sealing protection: IP67 (higher than the standard)

APPLICATIONS

Portable Electric Vehicle Supply Equipment (EVSE) for grid-to-vehicle charging

AVAILABLE CONFIGURATIONS

Design	Rubber overmold
Inlet Standard	IEC62196 Type II

TECHNICAL CHARACTERISTICS

Mating Cycles	10 000
---------------	--------

PERFORMANCE

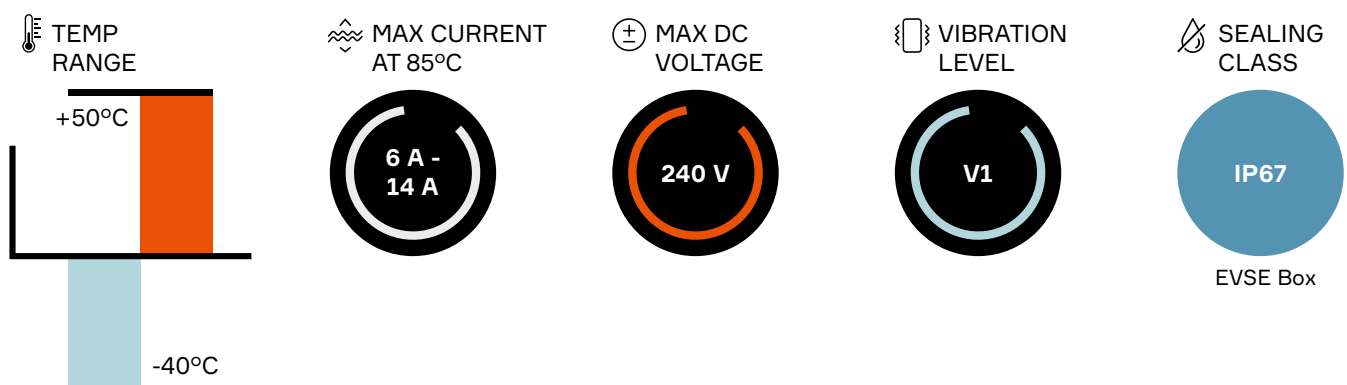

Part number	Type (veh/wall)	Current	# Phase	Cable length	Countries*	Certification
35054780	Type 2	10A	1-phase	5.0 / 16.40	Europe (Germany, France...)	CE
35086913	Type 2	8A	1-phase	5.0 / 16.41	Finland	CE
35054781	Type 2	10A	1-phase	5.0 / 16.42	UK, Ireland, Cyprus, Malta	CE
35058252	Type 2	6A	1-phase	5.0 / 16.43	Denmark	CE
35054782	Type 2	8A	1-phase	5.0 / 16.44	Switzerland	CE
35054784	Type 2	10A	1-phase	5.0 / 16.45	Norway	CE
35054788	Type 2	8A	1-phase	5.0 / 16.46	Italy	CE
35268956	Type 2	14A	1-phase	5.0 / 16.47	Europe - Grid plug CEE 16/3	CE

* Other countries outside Europe also available.

COMPATIBLE WITH



DIMENSION MEASUREMENT SAMPLE

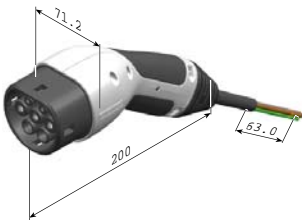

Type II
Rubber Over Mold

Part numbers, specifications, dimensions and performance data in this document are for general references only and are subject to change without notice. To verify product information, please contact an Aptiv representative.

CHARGE INLET TYPE I



BENEFITS

- Interface complies with SAE J1772 and IEC62196 Type I standard
- Panel mounts to vehicle
- Protective grommet/wire dress mounts to inlet

FEATURES

- Supports multiple levels of AC currents: Level 1 (15A, 120V) and Level 2 (32A, 240V)
- Validation: UL recognized

APPLICATIONS

Plug-in hybrid and electric on-vehicle charge inlet (1-phase AC charging)

TECHNICAL CHARACTERISTICS

Validation	UL recognized
Mating Cycles	10 000

AVAILABLE CONFIGURATIONS

Connector Type	Vehicle inlet
Cable Exit Orientation	180°
Cable Range (mm ²)	2 - 5 (AC)
Terminal Type	Round terminals
# of Terminals	AC: 3 Signal: 2
Shielding Type	Unshielded

PERFORMANCE

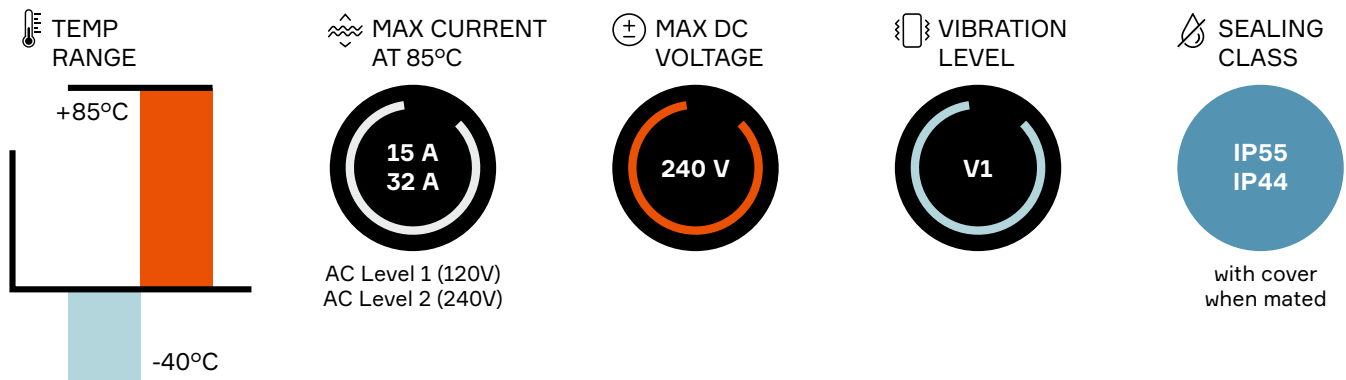

Part number	Description	BOM
13826395	Cover opens left	1

ASSOCIATED PARTS

Part Number	Description	Wire size range (AWG)	Wire section (mm ²)	BOM
Terminals				
13884348	1.5 mm pin	18	0.75	2
13884350	2.8 mm pin	14	2.5	1
13884351	2.8 mm pin	10	5	
13884352	3.6 mm pin	14	2.5	2
13884353	3.6 mm pin	10	5	

Part number	Description	BOM
Grommet		
13826280	Grommet wire protection	1

Part number	Description	BOM
TPA		
13826277	TPA	1

DIMENSION MEASUREMENT SAMPLE

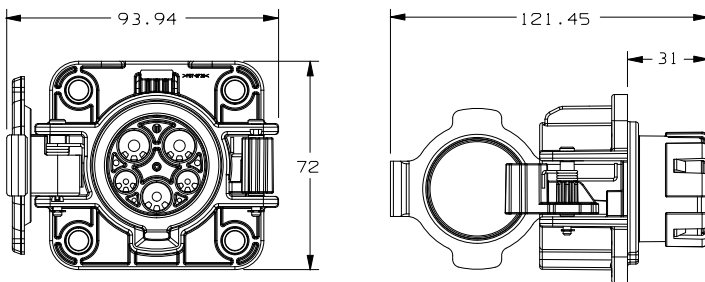

13826395

Part numbers, specifications, dimensions and performance data in this document are for general references only and are subject to change without notice. To verify product information, please contact an Aptiv representative.

CHARGE INLET TYPE II



BENEFITS

- Interface complies with IEC62196
- Panel mounts to vehicle
- Integrated thermal circuit breaker to prevent abnormal temperature increase

FEATURES

- Cover provides dust protection
- Inlet designed to drain fluids when opened
- Lock actuator positioned on the top
- Available with cover opening right or left

APPLICATIONS

Plug-in hybrid and electric on-vehicle charge inlet (1-phase or 3-phase AC charging)

AVAILABLE CONFIGURATIONS

Connector Type	Vehicle inlet
Cable Exit Orientation	90° (left or right)
Cable Range (mm ²)	2.5 - 16 (AC)
Terminal Type	Round terminals
# of Terminals	AC: 5 Signal: 2
Shielding Type	Unshielded

TECHNICAL CHARACTERISTICS

Mating Cycles 10 000

PERFORMANCE

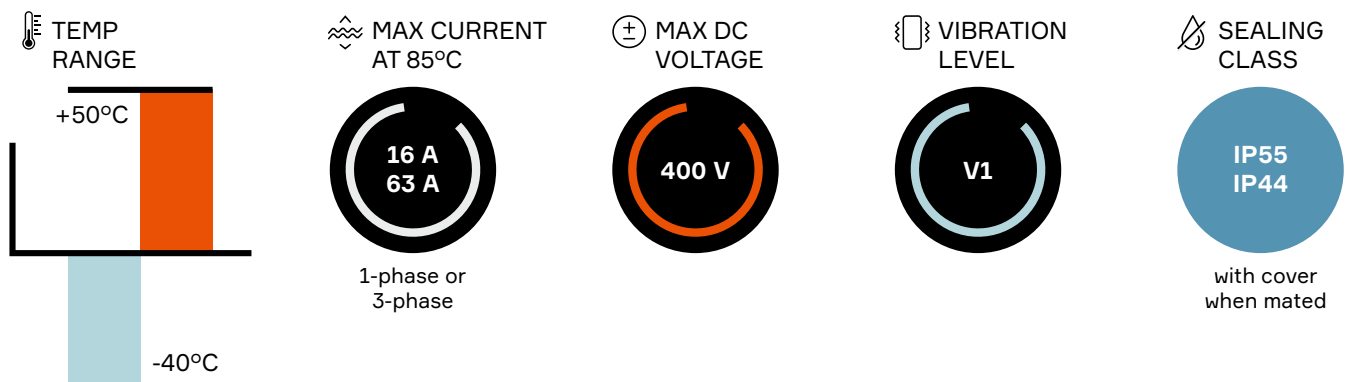

Part number	Description	BOM
33402098 33400030	Inlet sub-assy - Inlet Type II right open cover, left wire exit Rear cover, left wire exit	1
OR		
33402097 33400076	Inlet sub-assy - Inlet Type II left open cover, right wire exit Rear cover, right wire exit	1

ASSOCIATED PARTS

Part Number	Description	Wire section (mm ²)	BOM (1-phase)	BOM (3-phase)
Terminals for 16A version (1-phase)				
33267394	Male terminal Ø 6 mm with cap Ag (N, L1)	2.5	2	-
33513981	Male terminal Ø 6 mm without cap Ni (PE)	2.5	1	-
33502256	Male terminal Ø 3 mm, length 13 mm (CP)	0.5	1	-
33502238	Male terminal Ø 3 mm, length 25 mm (PP)	0.5	1	-
Terminals for 32A version (1-phase or 3-phase)*				
33403032	Male terminal Ø 6 mm with cap Ag (N, L1, L2, L3)	6	2	4
33403033	Male terminal Ø 6 mm without cap Ag (PE)	6	1	1
33502256	Male terminal Ø 3 mm, length 13 mm (CP)	0.5	1	1
33502238	Male terminal Ø 3 mm, length 25 mm (PP)	0.5	1	1
Terminals for 63A version (1-phase or 3-phase)*				
33267396	Male terminal Ø 6 mm with cap Ag (L1, L2, L3, N)	16	2	3 or 4
33267394	Male terminal Ø 6 mm with cap Ag (N)	4	-	1 or 0
33267382	Male terminal Ø 6 mm without cap Ag (PE)	16	1	1
33502256	Male terminal Ø 3 mm, length 13 mm (CP)	0.5	1	1
33502238	Male terminal Ø 3 mm, length 25 mm (PP)	0.5	1	1

* Compulsory usage of thermo sensor set

Part number	Description	BOM
Grommet		
33401379	Grommet	1
Screw		
33514388	Screw	3

Part number	Description	BOM
TPA		
33508692	TPA	1
Thermo Sensor		
33514398	Thermo sensor set	1

DIMENSION MEASUREMENT SAMPLE

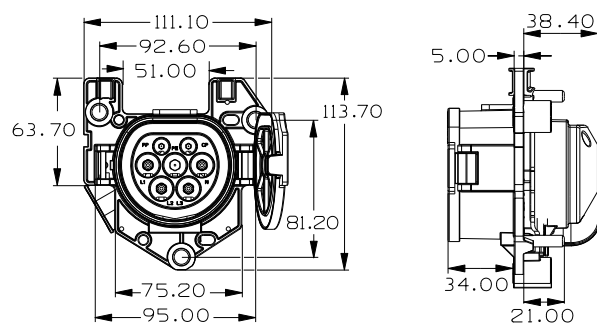

33402098

Part numbers, specifications, dimensions and performance data in this document are for general references only and are subject to change without notice. To verify product information, please contact an Aptiv representative.

COMBO 1 INLET



BENEFITS

- Interface complies with IEC62196
- Combined charging system for electrical vehicle
- AC/DC: slow (1-phase 32A) / fast charge (600V, 125A)

FEATURES

- Actuator located from a top position point enabling locking connector to inlet during charging
- Wire Cross Section:
Contact Pin/Present Pin (0.5 mm²),
PE (16 mm²), L1/N (6.0 mm²),
DC +/- (35 mm²)

APPLICATIONS

Plug-in hybrid and electric on-vehicle charge inlet (combined 1-phase AC and DC charging)

TECHNICAL CHARACTERISTICS

Connection/Inlet mating and unmating force < 100 N

Mating Cycles 10 000

AVAILABLE CONFIGURATIONS

Connector Type	Vehicle Inlet
Cable Exit Orientation	180°
Cable Range (mm ²)	6 (AC) 35 (DC)
Terminal Type	Round Terminals
# of Terminals	AC: 3 Signal: 2 DC: 2
Shielding Type	Unshielded

PERFORMANCE

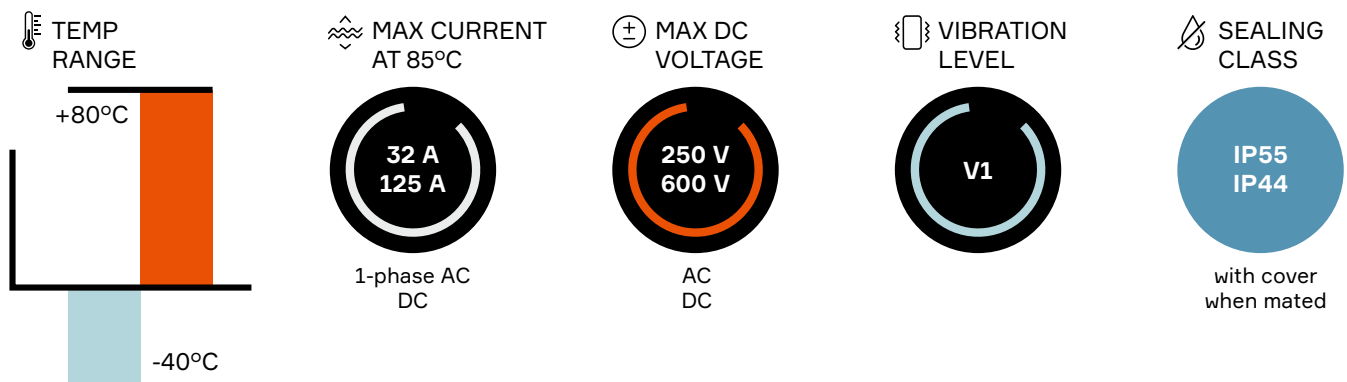

Part number	Description	BOM
33133127	Main Housing	1

ASSOCIATED PARTS

Part number	Description	BOM
Terminals		
15522876	Ø 3.6 mm / 6 mm ² cable cross section (AC power N, L1, L2 with protection cap)	2
15522875	Ø 2.8 mm / 16 mm ² cable cross section (Ground)	1
13884348	Ø 1.5 mm (Pilot)	2
15522877	Ø 8.0 mm / 35 mm ² (DC power)	2
Components and Accesories		
33133129	AC back cover	1
33133126	AC block seal cable (6 mm ² cable)	1
33133116	AC block seal terminal	1
33133128	DC back cover	1
33133115	DC block seal cable	1
33133108	DC retainer	1
33103899	DC O-ring	2
33133132	AC retainer	1
15532546	Screw	7
Dust Caps		
33133134	Dust caps	1
Actuator and Seals		
33235151	Actuator Combo 1	1
33133105	Block seal for actuator	1

DIMENSION MEASUREMENT SAMPLE

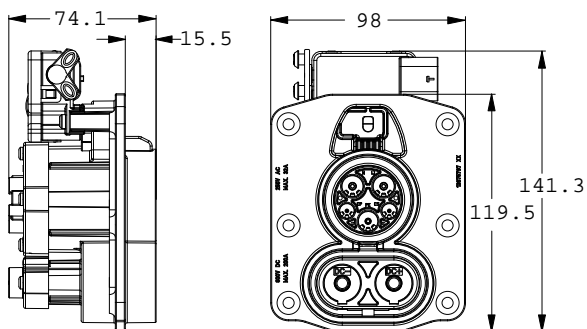

33133127

COMBO 2 INLET



BENEFITS

- Interface complies with IEC62196
- Combined charging system for electrical vehicle
- AC/DC: slow (3-phase, 20A) / fast charge (600V, 125A)

FEATURES

- Actuator located from a top position point enabling locking connector to inlet during charging
- Wire cross section:
Contact Pin/Present Pin (0.5 mm²),
PE (16 mm²), L1/N (4.0 mm²),
DC +/- (35 mm²)

APPLICATIONS

Plug-in hybrid and electric on-vehicle charge inlet (combined 3-phase AC and DC charging)

TECHNICAL CHARACTERISTICS

Connection/Inlet mating and unmating force < 100 N

Mating Cycles 10 000

AVAILABLE CONFIGURATIONS

Connector Type	Vehicle Inlet
Cable Exit Orientation	180°
Cable Range (mm ²)	4 (AC) 35 (DC)
Terminal Type	Round Terminals
# of Terminals	AC: 5 Signal: 2 DC: 2
Shielding Type	Unshielded

PERFORMANCE

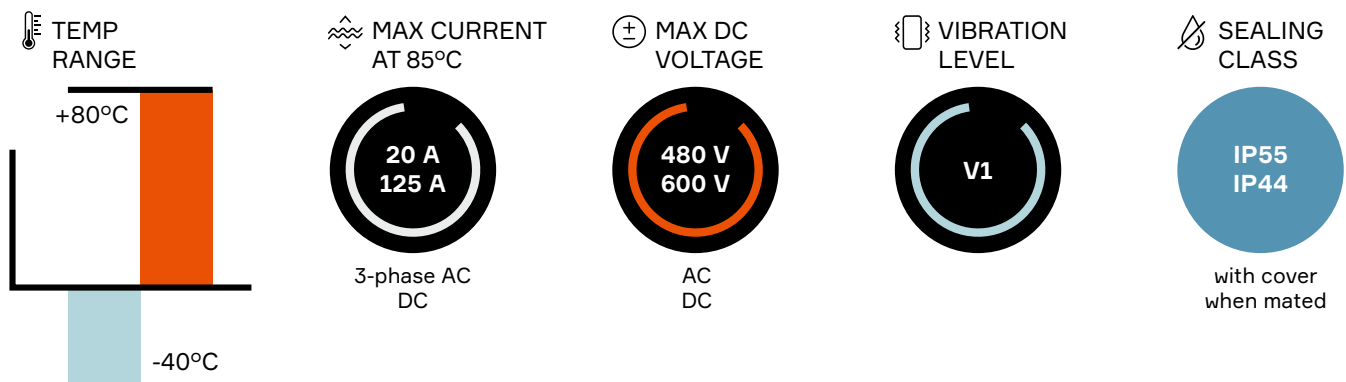

Part number	Description	BOM
33265593	Main Housing	1

ASSOCIATED PARTS

Part number	Description	BOM
Terminals		
33133795	Ø 6 mm / 4 mm ² cable cross section (AC power with protection cap)	2 or 4
15522870	Ø 6 mm / 16 mm ² cable cross section (PE/Ground)	1
33133789	Ø 3 mm (PP/Pilot)	1
33133739	Ø 3 mm (CP/Pilot)	2
Components and Accesories		
33265597	AC back cover	1
33265958	AC block seal cable (4 mm ² cable)	1
33265598	AC retainer	1
33265965	AC block seal terminal	1
33133855	DC backcover	1
33133931	DC block seal cable	1
33133859	DC retainer	1
33103899	DC O-ring	2
15532546	Screw	7
Dust Caps		
33134019	Dust caps	1
Actuator and Seals		
10808197	Actuator Combo 2	1
33133105	Block seal for actuator	1

DIMENSION MEASUREMENT SAMPLE

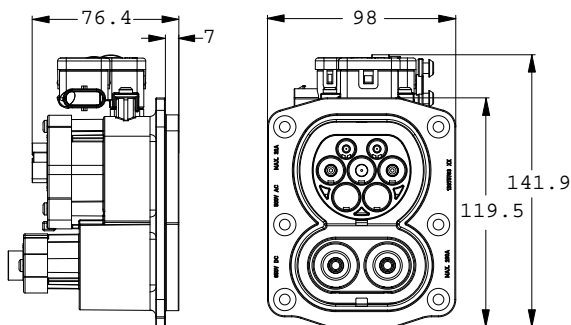

33265593

For **more** information:

Visit our website: <http://aptiv.com/>

Browse our E-catalog: <http://ecat.aptiv.com/>

Contact your local distributor:



Asia Pacific
Regional Operations

200 Yuanguo Road
Anting, Jiading District
Shanghai, 201814 China
Tel: (86) 21.5956.2200

Europe
Customer Center

ZI des longs Réages,
28230 Épernon
France
Tel: (33) 237.187.600
Germany
Tel: (49) 202.291.0

North America
Customer Center

5725 Innovation Drive
Troy, Michigan 48098-2815
USA
Tel: (1) 248.813.2000

South America
Regional Operations

APTIV Automotive Systems
do Brasil Ltda.
Rod. dos Tamoios, Km 21,8
Jambeiro, Sao Paulo
12270-000 Brazil
Tel: (55) 12.3978.2098

Mouser Electronics

Authorized Distributor

Click to View Pricing, Inventory, Delivery & Lifecycle Information:

[Aptiv:](#)

[35098453](#) [33272561](#) [33282936](#) [35092239](#) [33511752](#) [35254366](#) [35199856](#) [35310180](#) [35326611](#) [35310181](#)
[35091447](#) [35254402](#) [35326613](#) [33273083](#) [35092244](#) [33269218](#) [35098437](#) [33272670](#)