

Enabling the  
Electronics  
Revolution

PIHER *sensing*  
*systems*  
an Amphenol® company

## Off-Highway Vehicle Solutions

Position, Speed and Current Sensors



# Position, Speed and Current Sensors

For agriculture, off-highway and construction vehicles

## TABLE OF CONTENTS

Introduction	2
Inductive Sensors	3
Hall-Effect Sensors	4
Inductive High-Speed Sensors	6
Speed and Direction Sensors	7
Current Sensors	8
Hall-Effect and Reed Switches	9
Application Examples	10

## PIHER *sensing systems* Amphenol Sensors

Piher Sensing Systems is a leading innovator in advanced position sensing technologies that enable our clients to accurately measure and control rotational and linear movements. We develop, manufacture and market custom and standard position sensors and controls that provide valuable real-time data needed to efficiently drive today's vehicles and machinery.

### CUSTOMIZATION

Our ability to develop and customize our product line to meet exacting requirements gives our customers a technological and competitive advantage over competitors. Our value-added services range from prototyping and custom development to supply chain facilitation through the mounting of sub-assemblies.

With more than 70 years' experience, Piher Sensing Systems has the capability to move seamlessly from prototyping to true high-volume production. This makes us a trusted partner for customers in automotive, off-road, industrial, appliance, medical and marine markets throughout the world.

### ENTREPRENEURIAL SPIRIT AND STABILITY OF GLOBAL AMPHENOL CORPORATION

As part of Amphenol, we benefit from the growth and development opportunities of a global corporation. We can rely on stability and financial strength that further support our continued investment in research and development. At the same time, Piher Sensing Systems retains the agility, creativity and entrepreneurial spirit of a medium-sized company that can quickly adapt to customer needs.

The Amphenol Sensors business unit (ASTG) offers the most diverse sensor portfolio for demanding regulatory and industry-driven applications. Close collaboration with our sister companies enables us to offer our clients a full spectrum of dedicated sensing solutions.



# Inductive Position Sensors

## Strayfield immune, rotary and linear sensors for harsh environments

With their high tolerance to mechanical misalignment, vibrations and tilt variations, Piher Sensing System's inductive position sensors are a perfect fit for absolute rotary or linear motion sensing in automotive applications. These magnet-free sensors detect the position of a solid metallic target that is sliding or rotating above a printed circuit board. Given the underlying technology inductive sensors are immune to stray-fields and do not need additional shielding.

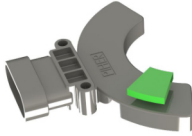
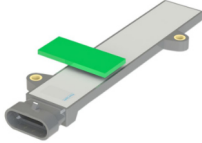

INDUCTIVE POSITION SENSORS		
	Rotary	Linear
		
Output	Analog (ratiometric), PWM, SENT	
Max. speed	1.000 rpm	n/a
Configuration	Through-shaft; End-of-shaft; Arc	n/a
Resolution	Analog (up to 12 bit) PWM (up to 14 bit) SENT (up to 14 bit)	
Linearity <sup>1</sup>	up to ±0,5%	
Supply voltage	5V ±10%	
Supply current	Typ. 14mA (single output)	
Voltage protection	+18V over voltage, -18V reverse voltage	
Life	Virtually unlimited	
Measurement range*	40° to 360° (no dead band)	Up to 800mm
Redundancy	Yes	
Sealing	IP67, IP69K	

\* Others to be studied upon request.

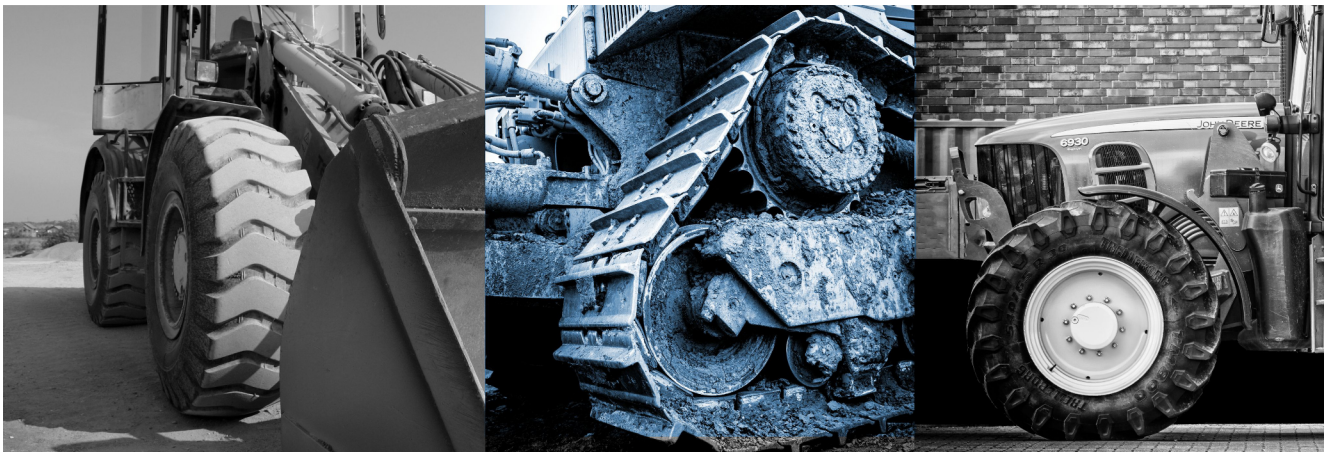

# Hall-Effect Position Sensors

Long-life and highly accurate 360° magnetic sensing

## CONTACTLESS THROUGH-SHAFT AND END-OF-SHAFT SENSORS

With truly non-contacting sensing (no gears inside subject to wear), high repeatability, low power consumption and wireless options, Piher Sensing System's hall-effect sensors provide an all-in-one integrated and maintenance-free position sensing solution for safety and high-reliability applications. Our sensors can be adapted to multi-turn applications, different shaft diameters or complete custom developments. Miniature versions give more flexibility for designs of space constraint applications.

## TOUCHLESS AND VARIABLE AIR GAP SENSORS

Our touchless variable air gap sensor creates immunity to radial and axial play on mobile shafts where significant misalignment results in poor operational performance and labor intensive maintenance programs. It complements our PS2P-LIN and PS2P-CON series of 2-piece touchless linear and angular position sensors and will deliver the same level of precision and stability throughout its life as on the first day. Despite extremes of vibration, shock, temperature and contamination. All our hall-effect sensors are easy to assemble thereby delivering additional cost reduction on the production line.







### END-OF-SHAFT SENSORS

Series	MSC-360	PSC-360	PSE-360 / PSE-290
			
Output	Analog, PWM	Analog, CAN, PWM, SPI	Analog, PWM
Resolution	Analog, PWM: 12bit SPI: 14bit	Analog, CAN, PWM: 12bit SPI: 14bit	Analog, PWM: 12bit SPI: 14bit
Linearity	±1.5% absolute	±1% absolute (±0.5% upon request)	
Supply voltage	5V ±10%	5V; 7V to 15V (25V)	5V ±10%
Supply current	Typ 12,6mA	Typ 8.5 mA (single) Typ 17 mA (redundant) Typ 47 mA (CAN versions)	Typ 8.5 mA
Voltage protection	+10V over voltage, -10V reverse voltage		±18V over / reverse voltage
Rotational life	Up to 7M cycles	Up to 50M cycles	
Switch output	No	Yes, programmable	No
Angular range*	90° to 360°	40° to 360° (multi turn up to 32 turns available)	50° to 360° 270° with end-stop
Redundancy	Yes		No
Shaft diameter	1.9mm	6mm	6.25mm
Mounting	Flange, Fly lead harness	Flange with fly lead harness or panel mount	Panel mount
Sealing	IP67	IP67	Not tested

\* Others available on request

## THROUGH-SHAFT SENSORS

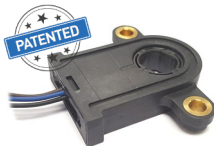
Series	MTS-360 	MTS-360PCB 	PST-360
			
Output	Analog, PWM, SPI		Analog, CAN, PWM, SPI
Resolution	Analog, PWM: 12bit; SPI: 14bit		
Linearity	±1% absolute (±0.5% upon request)		
Supply voltage	5V ±10%		5V; 7V to 15V (25V)
Supply current	Single version: Typ 8.5 mA Redundant version: Typ 17 mA		Single version: Typ 8.5 mA Redundant version: Typ 17 mA CAN version: Typ 47 mA
Voltage protection	+20V over voltage, -10V reverse voltage		+10V over voltage, -10V reverse voltage
Rotational life	Up to 50M cycles		
Switch output	Yes, programmable		
Angular range*	40° to 360° (no dead band)		
Redundancy	Yes		
Rotor diameter	4mm		14mm or 17mm
Mounting	SMD	Flange, Molex connector	Flange, Fly lead harness
Sealing	IP50		IP67; IP69K

\* Others available on request

## 2-PIECE TOUCHLESS SENSORS

Series	PS2P-LIN	PS2P-CON	PS2P-ARC
			
Type	Linear	Rotary concentric	Rotary variable air gap
Output	Analog (ratiometric), PWM, SPI		Analog, CAN, PWM
Resolution	Analog, PWM: 12bit SPI: 14bit		Up to 12 bit
Linearity	±1% absolute (±0.5% upon request)		
Supply voltage	5V; 7V to 15V (25V)		
Supply current	Single version: Typ 8.5 mA Redundant version: Typ 17 mA		Single version: Typ 8.5 mA Redundant version: Typ 17 mA CAN version: Typ 47 mA
Voltage protection	+10V over voltage, -10V reverse voltage		
Life	Virtually unlimited		
Switch output	Yes, programmable		
Measurement range	25mm (higher on request)	Up to 360°	Up to 110°
Redundancy	Yes		
Nominal air gap	3mm		2mm ±1mm
Maximum air gap	5mm		Custom
Sealing	IP67, IP69K		

Other specifications: check availability

# Inductive High-Speed Rotary Sensor

## Motor position sensing for electric and hybrid vehicles

Accurate feedback on the angular position, direction, and speed of the rotor shaft is essential to optimize control of the motor inverter and drive the electric engine with the best possible efficiency. With lower weight, smaller dimensions, immunity to stray fields and comparably lower cost, Piher Sensing System's inductive position sensing technology offers a true alternative to traditional resolvers. The possibility to perfectly customize the sensor to the motor dimensions enables more flexibility in the development of the electric / hybrid powertrain of the future.



INDUCTIVE HIGH-SPEED ROTARY POSITION SENSOR			
	End-of-Shaft	Through-Shaft	Arc
Signal output	Analog: demodulated differential (-3V to +3V) or single-ended (+1V to +4V) sine/cosine Digital*: ABI, SPI, SENT, AB, PWM		
Max. speed	Up to 600.000 rpm (el)		
Resolution	Analog: infinite Digital*: 14 bit		
Propagation delay	< 4.2 µsec		
Accuracy	±0.3°el		
Operating temperature	-40°C to +160°C		
Power consumption	< 20mA		
Sealing	IP69K		

\* Check availability

### PSCI - END-OF-SHAFT SENSOR

3-/4-/6-pole pair version available for testing

PSCI - TECHNICAL SPECIFICATIONS	
Signal output	Analog: differential sine/cosine (-3V to +3V)
Max. speed	200.000 rpm (3-pole pair version) 150.000 rpm (4-pole pair version) 100.000 rpm (6-pole pair version)
Accuracy	±1°el
Operating temperature	-40°C to +125°C (coil temperature can be > 150°C)
Supply voltage	5V ±10%
Current	Max 15 mA; ±18V over/reverse voltage protection
Mounting torque	Max 2.2 N m

For more information contact [info@piher.net](mailto:info@piher.net) or visit: [PSCI](#)



# Gear-Tooth Speed Sensors

## Solid state hall-effect wheel speed and direction sensors

The flange mount gear tooth speed and direction sensors of Piher Sensing Systems are designed to precisely calculate speed and direction of ferrous gears in demanding environments such as vehicle transmissions. The hall-effect sensor measures the variation in flux found in the airgap between the magnet and the passing teeth. Based on its touchless technology and rugged design our speed sensors provide true long-term reliability.



### KEY FEATURES

- ▶ Speed and direction feedback
- ▶ Operating temperature of 125°C (higher on demand)
- ▶ Fast and near zero speed sensing capable
- ▶ Compact and rugged for automotive & industrial areas
- ▶ Sealed for harsh environments: IP67
- ▶ Resistant to moist and high vibration environments such as engines, transmissions, brakes and chassis systems
- ▶ ESD protection
- ▶ Easily customizable cable or connector interface

### TECHNICAL SPECIFICATIONS

	Two Wire Current Source	A/B Signal
Air gap	1.5mm	
Maximum speed	12 kHz (forward) / 7 kHz (reverse)	40 kHz
Operating temperature	-40°C to +125°C (higher ranges possible)	
Sealing	IP67	
Operating voltage range	4VDC to 24 VDC	
Reverse supply voltage	-18 VDC	
Supply current	Low state: 5.9 to 8 mA High state: 12 to 16 mA	Typ. 10 mA
Power-on time	1 ms	
Output risetime	10 μs	5 μs
Output falltime	10 μs	5 μs

### CUSTOMIZATION POSSIBILITIES

Custom product design can easily be provided to meet any form, fit and function including the choice of wire harness and interface connector.

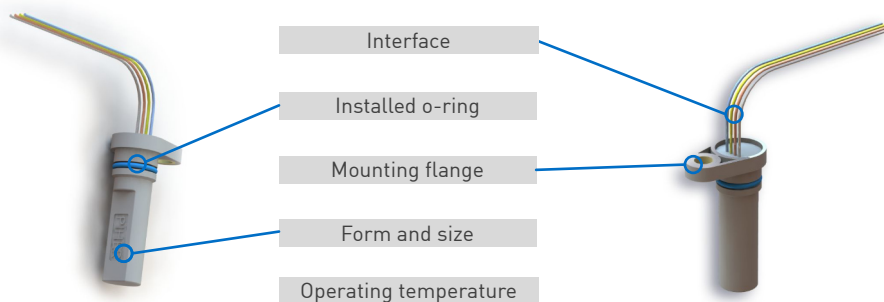

# Current Sensors

## Automotive Grade Sensors

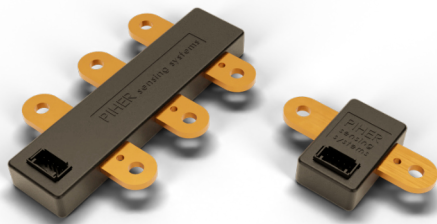

### TMR BASED

Accurate measurement, high sampling rate and low temperature drift.

#### KEY FEATURES

- ▶ Galvanic separation between power and control
- ▶ Measured current values up to  $\pm 4000A$
- ▶ Immunity to common mode fields
- ▶  $\pm 2kV$  ESD protection

### HALL-EFFECT BASED

Open loop current sensor that generates a signal proportional to the current flowing through the conductor.

#### KEY FEATURES

- ▶ Galvanic separation between power and control
- ▶ Measured current values from  $\pm 200A$  to  $\pm 1500A$
- ▶ Simple or redundant analog ratiometric output
- ▶ 10V voltage protection

### SPECIFICATIONS

Parameter	TMR models	Hall Effect models
Output	Analog ratiometric	
Current measuring range	Up to $\pm 4000A$	Up to $\pm 1500A$
Supply voltage	4.75V to 5.5V	5V $\pm 10\%$
Supply current	6 mA to 9 mA	9 mA to 14 mA
Current type	AC, DC	
Output voltage	0.5V to 4.5V $\pm 10\%$	
Accuracy at 25°C*	< 1%	< 2%
Operating temperature	-40°C to 125°C	
Response time	~ 300 nsec	< 3 $\mu$ sec
Frequency bandwidth	DC to 1 MHz	DC to 200kHz
Mounting type	Integrated busbar with hole fastening	

\* Depending on measurement range



### APPLICATIONS

- ▶ Battery management
- ▶ Motor control
- ▶ EV motor inverters
- ▶ DC/DC converters
- ▶ Over-voltage detection

# Hall-Effect and Reed Switches

## Reliable position feedback for seat belt buckles

Seat belt buckle sensors detect whether the buckle tongue is currently latched and feedback this information to alert the driver, adjust airbag deployment or block vehicle ignition. Piher Sensing Systems can provide custom solutions based on hall-effect or reed switch technology for accurate performance under harsh and challenging environmental conditions. Based on fully sealed, contactless technology without moving parts or external magnets these sensors save space, cost and set-up operating.

Custom packaging including the choice of wire harness, connector options and electrical values can be provided.

Alternative applications include hood latch, liquid level or HVAC compressor status control.



HALL-EFFECT SENSOR	
<b>Electrical Specifications</b>	
Sensor logic	Bi-state
Voltage	2.7V to 24V
Over-/reverse voltage protection	32 Vdc max / -30Vdc max.
Current	Switching low Switching high
	5.0mA / 6.9mA 12.0mA / 17.0mA
Resistance	Circuit Isolation
	100Ω max. > 20MΩ max.
<b>Environmental Specifications</b>	
Operating temperature	-40°C to +85°C
Storage temperature	-40°C to +140°C

REED SWITCH	
<b>Electrical Specifications</b>	
Sensor logic	Normally open
Voltage	16Vdc max.
DC switched current output	0.35A max.
Switch power	5W max.
<b>Environmental Specifications</b>	
Operating temperature	-40°C to +85°C

# Sensor Applications

Our position sensors are made for the harsh environments of the HVOR market and comply with safety critical requirements. Beyond the development and manufacturing of sensors we also offer connector and cable assembly. With different technologies available, we will develop the most suitable solutions for your specific requirement.



## PEDAL-BY-WIRE

Based on inductive or hall-effect technology the contactless pedal position sensors are easily mounted and virtually maintenance free. Switch options (e.g. for break lights) are programmable.

## STEERING ANGLE POSITION

Steer-by-wire systems replace the mechanical connection between steering wheel and chassis. Our multi-turn position sensors enable precise steering, are robust to the environmental conditions and measure the movement of the steering shaft directly at the source.

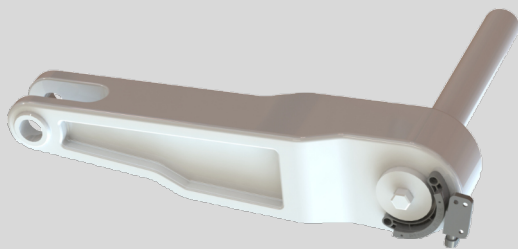

## HITCH ANGLE POSITION

Measuring large shafts can be a challenge especially due to changing airgaps during the product life time. Our variable airgap Arc sensors bridge the gap and enable precise measurement of rear and front hitch or bucket position.

## ARM POSITION

The inductive arc sensor is fixed to the boom arm while a metallic target is mounted on the moving arm. Movement of the arm is picked up by the sensor who feeds back the relative position of the target to the operating system.

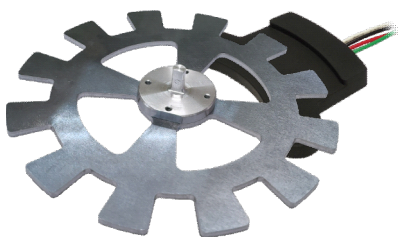
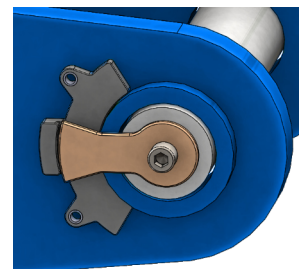

## E-MOTOR CONTROL

With lower weight, smaller dimensions, immunity to strayfields and comparably lower cost, Piher Sensing System's inductive position sensing technology offers a true alternative to traditional resolvers.

## TRANSMISSION SYSTEMS

We provide linear, rotary and speed sensor solutions to measure transmission input and output speed, gear speed and gear position.

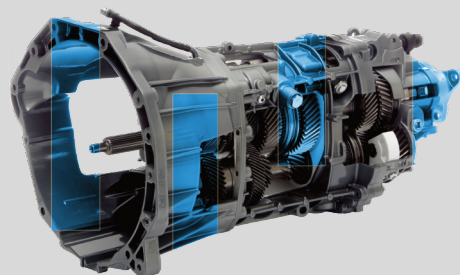

## Agriculture and Forestry

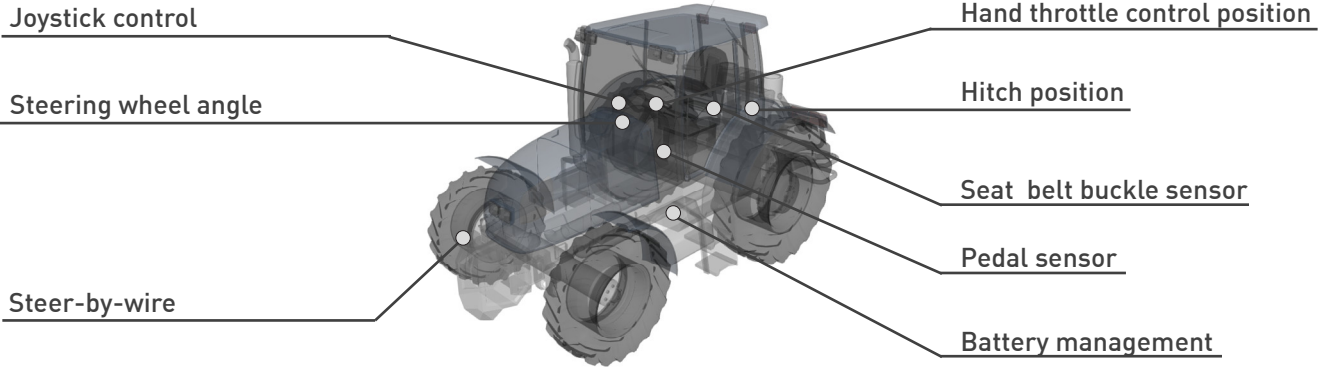

## Material Handling

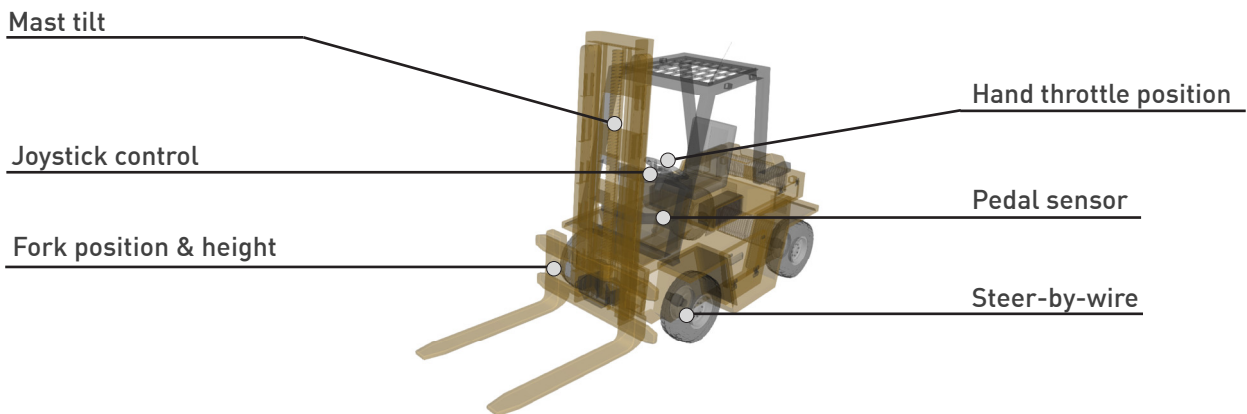

## Construction

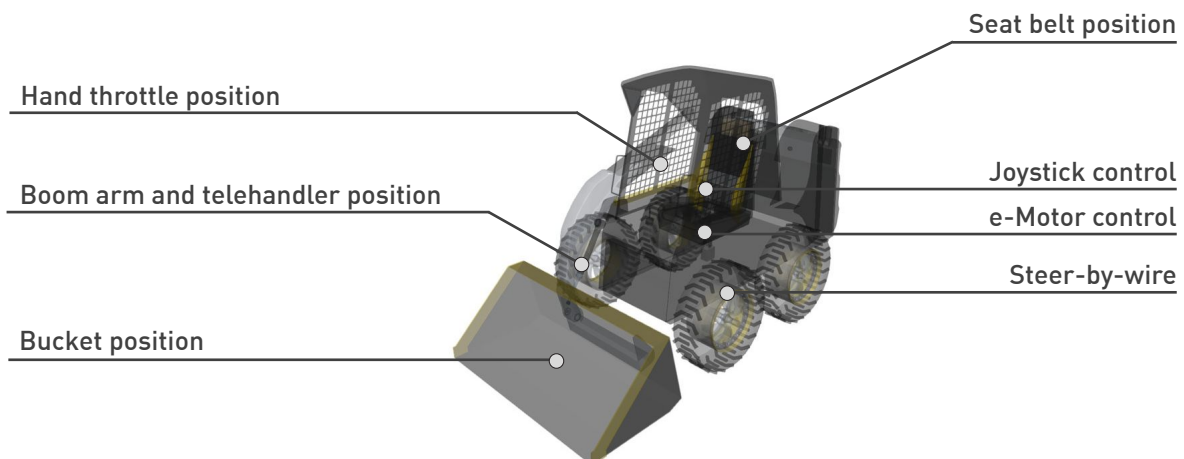

## CONTACT

### Piher Sensing Systems

Polígono Industrial Municipal  
Vial T2, N°22  
31500 Tudela  
Spain  
[www.piher.net/contactless](http://www.piher.net/contactless)

Europe: +34 948 820 450  
Americas: +1 636 251 0855  
Asia Pacific: +65 9641 8886  
India: +91 9538 686 586  
[sales@piher.net](mailto:sales@piher.net)

The product information in this catalog is for reference purposes. Please consult for the most up to date and accurate design information. Piher Sensors & Controls S.A., its affiliates, agents, and employees, and all persons acting on its or their behalf (collectively, "Piher"), disclaim any and all liability for any errors, inaccuracies or incompleteness contained herein or in any other disclosure relating to any product described herein.

Piher disclaims any and all liability arising out of the use or application of any product described herein or of any information provided herein to the maximum extent permitted by law. The product specifications do not expand or otherwise modify Piher's terms and conditions of sale, including but not limited to the warranty expressed therein, which apply to these products.

No license, express or implied, by estoppel or otherwise, to any intellectual property rights is granted by this document or by any conduct of Piher.

The products shown herein are not designed for use in medical, life-saving, or life-sustaining applications unless otherwise expressly indicated. Customers using or selling Piher products not expressly indicated for use in such applications do so entirely at their own risk and agree to fully indemnify Piher for any damages arising or resulting from such use or sale. Please contact authorized Piher personnel to obtain written terms and conditions regarding products designed for such applications.

Product names and markings noted herein may be trademarks of their respective owners. Information contained in and/or attached to this catalogue may be subject to export control regulations of the European Community, USA, or other countries. Each recipient of this document is responsible to ensure that usage and/or transfer of any information contained in this document complies with all relevant export control regulations. If you are in any doubt about the export control restrictions that apply to this information, please contact the sender immediately. For any Piher Exports, Note: All products / technologies are EAR99 Classified commodities. Exports from the United States are in accordance with the Export Administration Regulations. Diversion contrary to US law is prohibited.



**PIHER** *sensing*  
*systems*  
an Amphenol® company

[www.piher.net](http://www.piher.net)

© 2022 Piher Sensors & Controls S.A.

Other logos, product and company names mentioned herein may be trademarks of their respective owners.  
Rev.23122022