

3M™ COAXPRESS INDUSTRIAL CAMERA CABLE ASSEMBLY, 1CXx-xx-0S SERIES

- SUPPORT COAXPRESS STANDARD (UP TO 8m LENGTH FOR CXP-12 AND 11m LENGTH FOR CXP-6)
- STANDARD FLEX DURABLE CABLE FOR BENDING/SLIDING APPLICATION (OVER 10 MILLION CYCLES WITH DRAG CHAIN AT R50mm)
- MICRO-BNC, BNC, 1.0/2.3(DIN) CONNECTOR AVAILABLE
- ROHS COMPLIANT AND CE MARKING

NOTES	
1	TOLERANCE OF CABLE LENGTH: ±100mm FOR LENGTH <10m ±200mm FOR LENGTH 10m TO 30m ±300mm FOR LENGTH 30m<
2	UNLESS OTHERWISE NOTED, REFERENCES TO INDUSTRY SPECIFICATIONS ARE INTENDED TO INDICATE SUBSTANTIAL COMPLIANCE TO THE MATERIAL ELEMENTS OF THE SPECIFICATIONS. SUCH REFERENCES SHOULD NOT BE CONSTRUED AS A GUARANTEE OF COMPLIANCE TO ALL REQUIREMENTS IN THE STANDARD

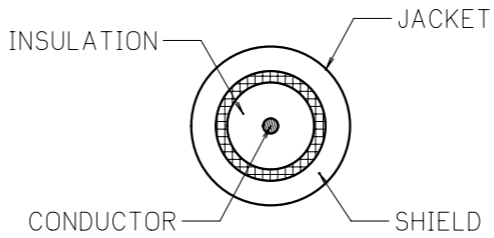
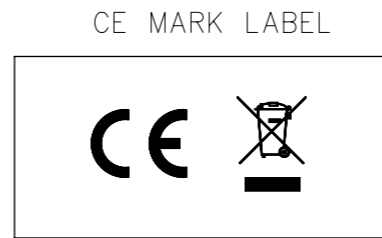
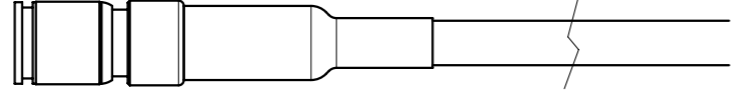
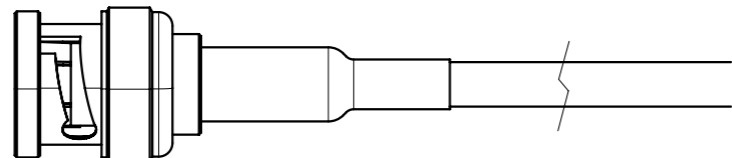
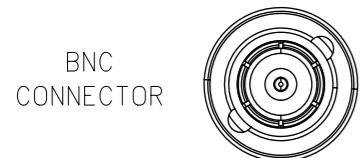
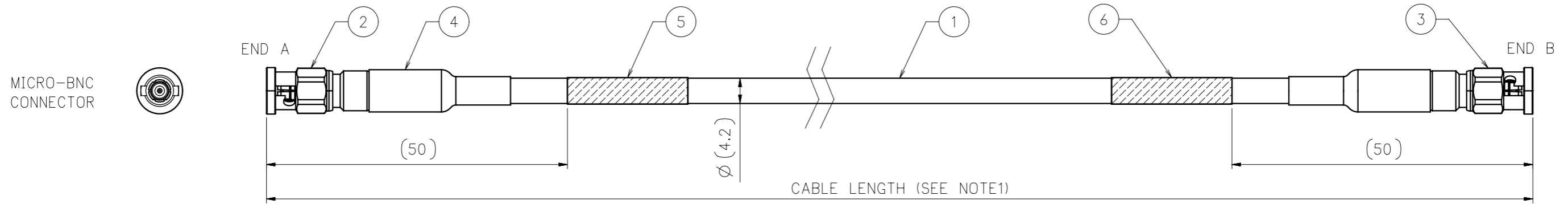

CABLE CROSS SECTION

REV.	ECO	ISSUE DATE AND DESCRIPTION	DRFT	CHKD
B	113721	DEC 27,2023 UPDATE FLEX DURABILITY	MN	TH
A	112599	OCT 20,2023 INITIAL RELEASE	MN	TH

ITEM	PART NAME	QTY	NOTE
6	CE MARK LABEL	1	COLOR: WHITE
5	PRODUCT LABEL	1	COLOR: WHITE
4	HEAT SHRINK TUBE	2	COLOR: BLACK
3	CONNECTOR (END B)	1	BODY MATERIAL: COPPER ALLOY
2	CONNECTOR (END A)	1	BODY MATERIAL: COPPER ALLOY
1	CABLE	1	JACKET: PVC COLOR: BLACK

TOLERANCES EXCEPT AS NOTED	DFTG M.NAITOU	DATE 10/13/23
INCHES .0 ± .5 .00 ± .20 .000 ± N/A	CHKD T.HAYAUCHI	DATE 10/13/23
	MFG	DATE
MILLIMETERS .0 ± .5 .00 ± .20 .000 ± N/A	APPVL Y.KAWATE	DATE 10/13/23
	© 3M COPYRIGHT 2023 THIS DOCUMENT CONTAINS INFORMATION WHICH IS PROPRIETARY TO 3M COMPANY. NO REPRODUCTION OR PUBLICATION OF THIS DOCUMENT, IN WHOLE OR IN PART, SHALL BE MADE WITHOUT AUTHORIZATION FROM 3M.	
ANGLES ±5°	 THIRD ANGLE PROJECTION	

 3M Center St. Paul, MN 55144		DIVISION EMSD	MODEL
TITLE 3M™ COAXPRESS INDUSTRIAL CAMERA CABLE ASSEMBLY 1CXx-xx-0S SERIES			
FSCM NO.	SIZE A3	DRAWING NO. 78-5100-2784-6	REV. B
SCALE		DET LISTS <input type="checkbox"/> YES <input type="checkbox"/> NO	SHT 1 OF 3

DRAWING NO. 78-5100-2784-6 REV. B

3M™ COAXPRESS INDUSTRIAL CAMERA CABLE ASSEMBLY, 1CXx-xx-0S SERIES

ORDERING INFORMATION

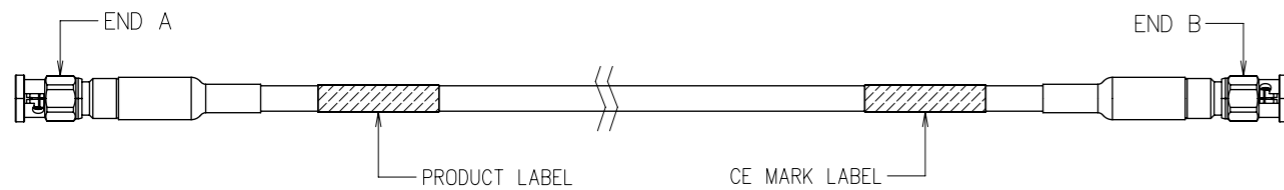
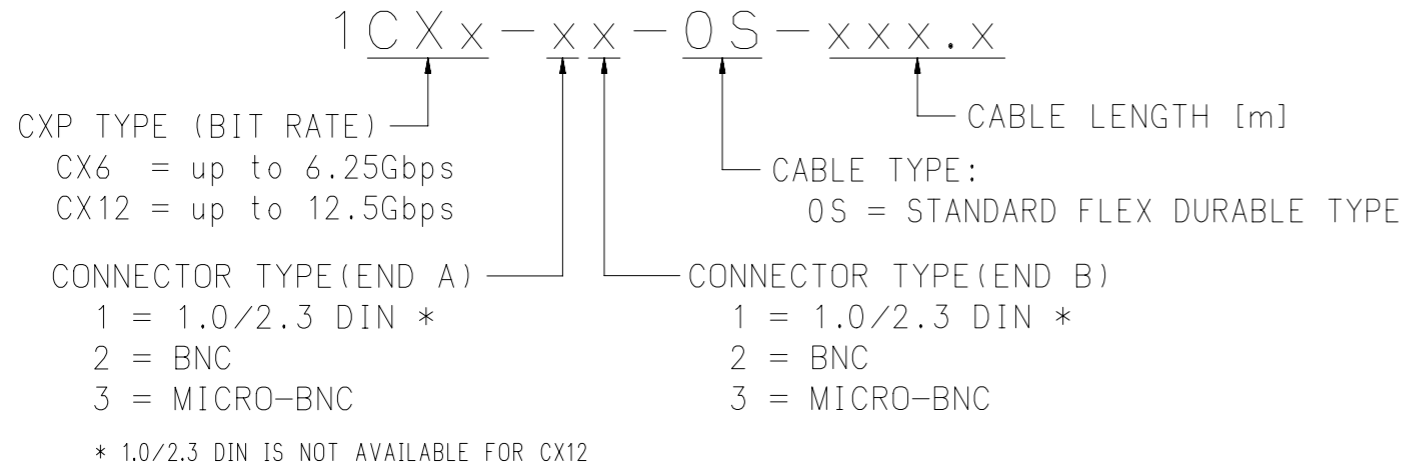

HARNESS LENGTH	PART NUMBER		
	MICRO-BNC CONNECTOR (Both A and B)	BNC CONNECTOR (Both A and B)	1.0/2.3 DIN CONNECTOR (Both A and B)
1m	1CX12-33-0S-001.0	1CX12-22-0S-001.0	1CX6-11-0S-001.0
2m	1CX12-33-0S-002.0	1CX12-22-0S-002.0	1CX6-11-0S-002.0
3m	1CX12-33-0S-003.0	1CX12-22-0S-003.0	1CX6-11-0S-003.0
4m	1CX12-33-0S-004.0	1CX12-22-0S-004.0	1CX6-11-0S-004.0
5m	1CX12-33-0S-005.0	1CX12-22-0S-005.0	1CX6-11-0S-005.0
6m	1CX12-33-0S-006.0	1CX12-22-0S-006.0	1CX6-11-0S-006.0
7m	1CX12-33-0S-007.0	1CX12-22-0S-007.0	1CX6-11-0S-007.0
8m	1CX12-33-0S-008.0	1CX12-22-0S-008.0	1CX6-11-0S-008.0

- OTHER LENGTHS AVAILABLE BY SPECIAL ORDER, CONTACT 3M FOR DETAILS.
 - DIFFERENT CONNECTOR COMBINATIONS AVAILABLE, BUT 1.0/2.3DIN CONNECTOR IS LIMITED TO CXP-6 APPLICATIONS.
 (ex. 1CX6-13-0S-010.0 : 1.0/2.3 DIN & MICRO-BNC WITH 10m LENGTH)

CABLE	
TEMPERATURE AND VOLTAGE RATING	60° C / 30V
IMPEDANCE	75 Ohm
CURRENT RATING	1A
SHEATH MATERIAL	PVC
COLOR	BLACK
OUTER DIAMETER	4.2mm
RECOMMENDED MIN. BENDING RADIUS	40mm
FLAMMABILITY	UL AWM HORIZONTAL

PERFORMANCE	
CXP SUPPORTING TRANSMISSION DISTANCE	8m(CXP-12), 11m(CXP-6) *
FLEX DURABILITY	OVER 10 MILLION CYCLES ** (WITH DRAG CHAIN R50mm)

* AVAILABLE LONGER FUNCTIONAL DISTANCE IN EACH TEST AND BOARD CONDITION.
 ** RESULT UNDER 3M TEST CONDITIONS.

ENVIRONMENTAL	
OPERATING TEMPERATURE	0 to 40° C

REV.	B	113721	DEC 27,2023 UPDATE FLEX DURABILITY	MN	TH
	A	112599	OCT 20,2023 INITIAL RELEASE	MN	TH
	ECO		ISSUE DATE AND DESCRIPTION	DRFT	CHKD

TOLERANCES EXCEPT AS NOTED	DFTG M.NAITOU	DATE 10/13/23
INCHES .0 ± .00 ± .000 ±	CHKD T.HAYAUCHI	DATE 10/13/23
	MFG	DATE
MILLIMETERS .0 ± .5 .00 ± .20 .000 ± N/A	APPVL Y.KAWATE	DATE 10/13/23
	© 3M COPYRIGHT 2023 THIS DOCUMENT CONTAINS INFORMATION WHICH IS PROPRIETARY TO 3M COMPANY. NO REPRODUCTION OR PUBLICATION OF THIS DOCUMENT, IN WHOLE OR IN PART, SHALL BE MADE WITHOUT AUTHORIZATION FROM 3M.	
ANGLES ±5°	THIRD ANGLE PROJECTION	

3M 3M Center St. Paul, MN 55144		DIVISION EMSD	MODEL
TITLE 3M™ COAXPRESS INDUSTRIAL CAMERA CABLE ASSEMBLY 1CXx-xx-0S SERIES		DIVISION CODE	
FSCM NO.	SIZE A3	DRAWING NO. 78-5100-2784-6	REV. B
SCALE		DET LISTS <input type="checkbox"/> YES <input type="checkbox"/> NO	SHT 2 OF 3

DRAWING NO. 78-5100-2784-6 REV. B

3M™ COAXPRESS INDUSTRIAL CAMERA CABLE ASSEMBLY, 1CXx-xx-0S SERIES

Regulatory: For regulatory information about this product, visit 3M.com/regs or contact your 3M representative.

Technical Information: The technical information, recommendations and other statements contained in this document are based upon tests or experience that 3M believes are reliable, but the accuracy or completeness of such information is not guaranteed.

Product Use: Many factors beyond 3M's control and uniquely within user's control can affect the use and performance of a 3M product in a particular application. Given the variety of factors that can affect the use and performance of a 3M product, user is solely responsible for evaluating the 3M product and determining whether it is fit for a particular purpose and suitable for user's method of application.

Warranty, Limited Remedy, and Disclaimer: Unless an additional warranty is specifically stated on the applicable 3M product packaging or product literature, 3M warrants that each 3M product meets the applicable 3M product specification at the time 3M ships the product. 3M MAKES NO OTHER WARRANTIES OR CONDITIONS, EXPRESS OR IMPLIED, INCLUDING, BUT NOT LIMITED TO, ANY IMPLIED WARRANTY OR CONDITION OF MERCHANTABILITY OR FITNESS FOR A PARTICULAR PURPOSE OR ANY IMPLIED WARRANTY OR CONDITION ARISING OUT OF A COURSE OF DEALING, CUSTOM OR USAGE OR TRADE. If the 3M product does not conform to this warranty, then the sole and exclusive remedy is, at 3M's option, replacement of the 3M product or refund of the purchase price.

Limitation of Liability: Except where prohibited by law, 3M will not be liable for any loss or damage arising from the 3M product, whether direct, indirect, special, incidental or consequential, regardless of the legal theory asserted, including warranty, contract, negligence or strict liability.

3M Company
 Electronics Materials Solutions Division
 13011 McCallen Pass, Bldg. C
 Austin, TX 78753-5380
 1-800-225-5373
www.3M.com/interconnect

REV.	ECO	ISSUE DATE AND DESCRIPTION	DRFT	CHKD
B	113721	DEC 27, 2023 UPDATE FLEX DURABILITY	MN	TH
A	112599	OCT 20, 2023 INITIAL RELEASE	MN	TH

TOLERANCES EXCEPT AS NOTED	DFTG M. NAITOU	DATE 10/13/23
INCHES .0 ± .00 ± .000 ±	CHKD T. HAYAUCHI	DATE 10/13/23
MILLIMETERS .0 ± .5 .00 ± .20 .000 ± N/A	MFG	DATE
ANGLES ±5°	APPVL Y. KAWATE	DATE 10/13/23

3M	3M Center St. Paul, MN 55144	DIVISION EMSD	MODEL
		DIVISION CODE	

TITLE 3M™ COAXPRESS INDUSTRIAL CAMERA CABLE ASSEMBLY 1CXx-xx-0S SERIES			
FSCM NO.	SIZE A3	DRAWING NO. 78-5100-2784-6	REV. B
SCALE		DET LISTS <input type="checkbox"/> YES <input type="checkbox"/> NO	SHT 3 OF 3

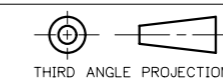

DRAWING NO. 78-5100-2784-6 REV. B